

## STRADA-SQ-ANZ-P

Beam for pedestrian lighting (P4 & P5) in Australia and New Zealand. Version with location pins.

### TECHNICAL SPECIFICATIONS:

Dimensions	25.0 mm
Height	8.1 mm
Fastening	glue, tape, pin, screw
Colour	clear
Box size	480 x 280 x 300 mm
Box weight	7.2 kg
Quantity in Box	2058 pcs
ROHS compliant	yes ⓘ

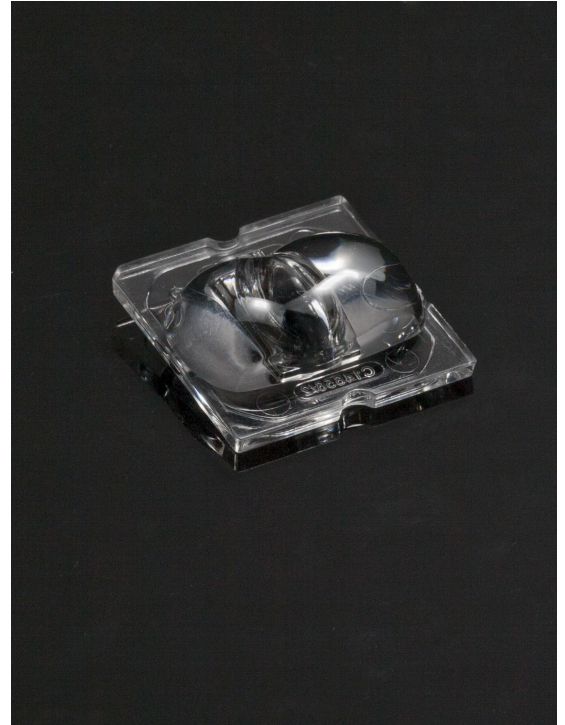

### MATERIAL SPECIFICATIONS:

Component	Type	Material	Colour
STRADA-SQ-ANZ-P	Lens	PMMA	clear

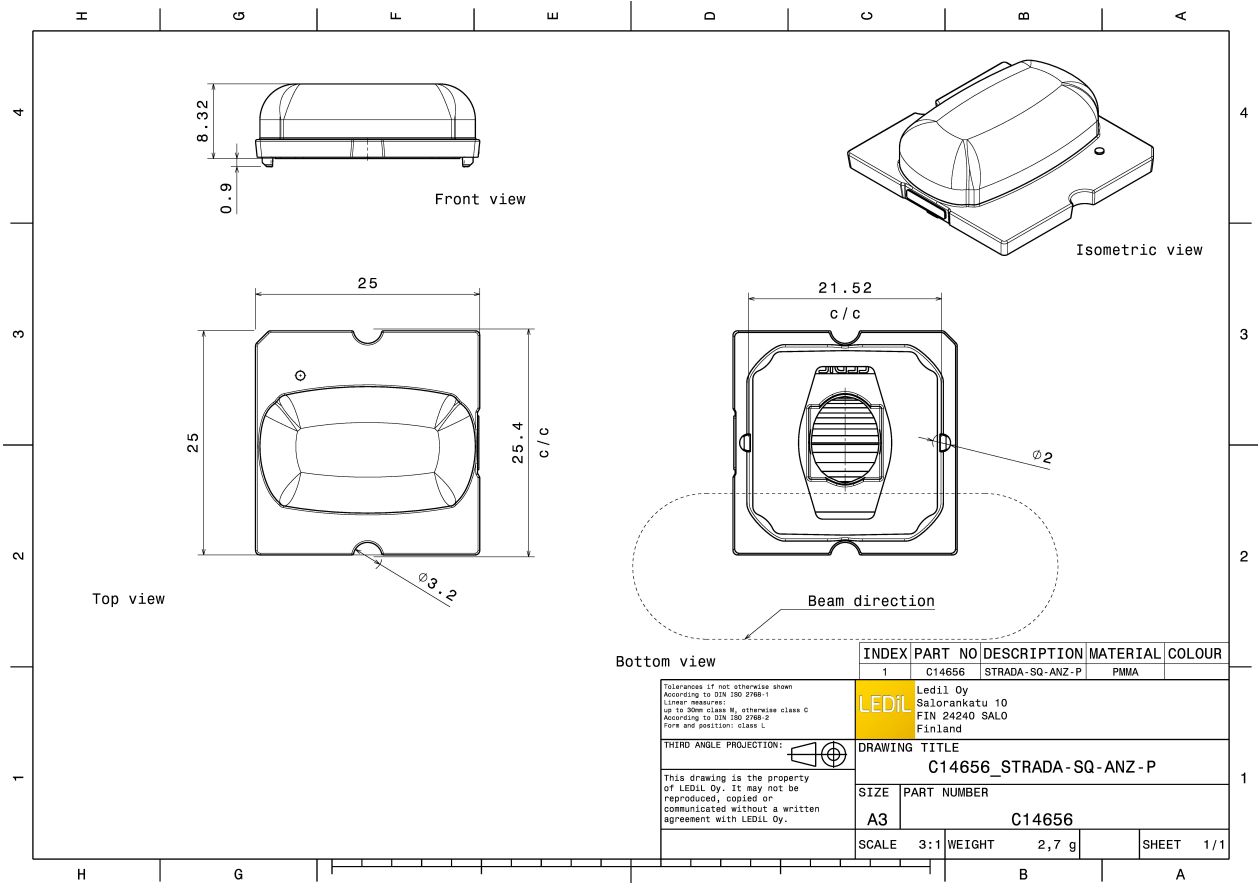

## PHOTOMETRIC DATA (MEASURED):



LED LUXEON M/MX  
FWHM Asymmetric  
Efficiency 94 %  
Peak intensity 0.520 cd/lm  
Required components:

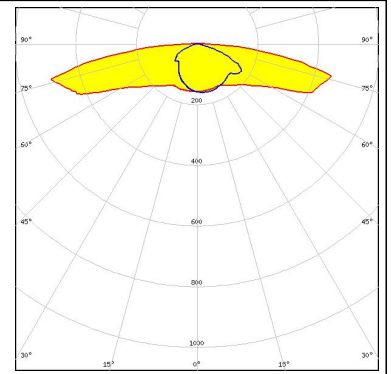

#### PHOTOMETRIC DATA (SIMULATED):



LED XHP35 HD  
FWHM Asymmetric  
Efficiency 90 %  
Peak intensity 0.670 cd/lm  
Required components:

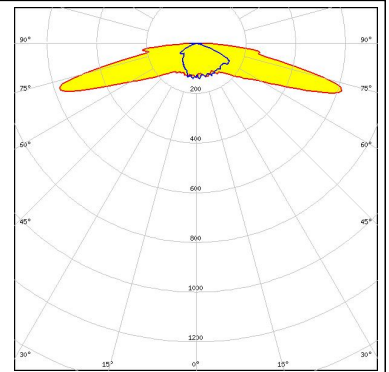

LED XHP35 HI  
FWHM Asymmetric  
Efficiency 92 %  
Peak intensity 0.750 cd/lm  
Required components:

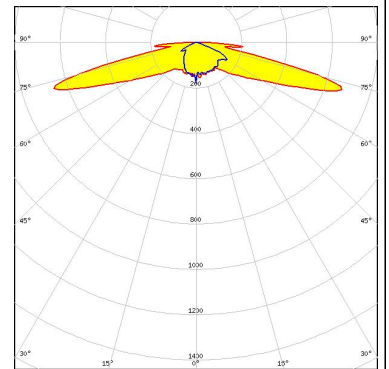

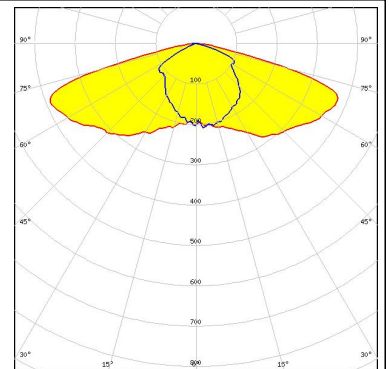

LED LUXEON 5050  
FWHM Asymmetric  
Efficiency 94 %  
Peak intensity 0.660 cd/lm  
Required components:

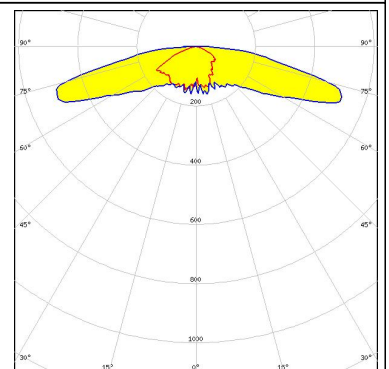

LED OSCONIQ P 7070  
FWHM Asymmetric  
Efficiency 91 %  
Peak intensity 0.547 cd/lm  
Required components:

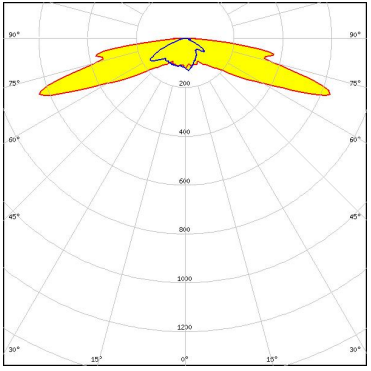

#### PHOTOMETRIC DATA (SIMULATED):

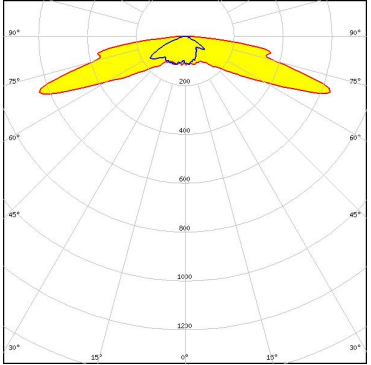
 SEOUL SEMICONDUCTOR	LED                    Z8Y19 FWHM                Asymmetric Efficiency            93 % Peak intensity        0.700 cd/lm Required components:	
 SEOUL SEMICONDUCTOR	LED                    Z8Y22 FWHM                Asymmetric Efficiency            93 % Peak intensity        0.690 cd/lm Required components:	

#### GENERAL INFORMATION:

NOTE: The typical beam angle will be changed by different color, chip size and chip position tolerance. The typical total beam angle is the full angle measured where the luminous intensity is half of the peak value.

#### MATERIALS:

As part of our continuous research and improvement processes, and to ensure the best possible quality and availability of our products, LEDiL reserves the right to change material grades without notice.

#### PRODUCT DATA USER AGREEMENT AND DISCLAIMER:

The measured data in the provided downloadable LEDiL Product Datasheets and Mechanical 2D-Drawings is rounded and provided as reference for planning. LEDiL Oy's optical specifications have been verified by conducting performance testing of the products in accordance with the company's quality system. The reported data are averaged results of multiple measurements with typical variation. LEDiL Oy reserves the right to without prior notification make changes and improvements to its products.

LEDiL Oy assumes neither warranty, nor guarantee nor any other liability of any kind for the contents and correctness of the provided data. The provided data has been generated with highest diligence but the provided data may in reality not represent the complete possible variation range of all intrinsic parameters. Therefore, in certain cases a deviation from the provided data could occur.

LEDiL Oy reserves the right to undertake technical changes of its products without further notification which could lead to changes in the provided data. LEDiL Oy assumes no liability of any kind for the possible deviation from any provided data or any other damage resulting from the usage of the provided data.

The user agrees to this disclaimer and user agreement with the download or usage of the provided files.

#### LEDiL Oy

Joensuunkatu 13  
FI-24240 SALO  
Finland

#### LEDiL Inc.

228 West Page Street  
Suite D  
Sycamore IL 60178  
USA

#### Local sales and technical support

[www.ledil.com/  
where\\_to\\_buy](http://www.ledil.com/where_to_buy)

#### Shipping locations

Salo, Finland  
Hong Kong, China

#### Distribution Partners

[www.ledil.com/  
where\\_to\\_buy](http://www.ledil.com/where_to_buy)