

620MHz – 1100MHz High Linearity Direct Quadrature Modulator

FEATURES

- Direct Conversion from Baseband to RF
- High Output: -4.2dB Conversion Gain
- High OIP3: 21.7dBm at 900MHz
- Low Output Noise Floor at 20MHz Offset:
 - No RF: -159dBm/Hz
 - $P_{\text{OUT}} = 4\text{dBm}$: -153.3dBm/Hz
- Low Carrier Leakage: -42dBm at 900MHz
- High Image Rejection: -53dBc at 900MHz
- 3-Ch CDMA2000 ACPR: -70.4dBc at 900MHz
- Integrated LO Buffer and LO Quadrature Phase Generator
- 50Ω AC-Coupled Single-Ended LO and RF Ports
- High Impedance DC Interface to Baseband Inputs with 0.5V Common Mode Voltage
- 16-Lead QFN $4\text{mm} \times 4\text{mm}$ Package

APPLICATIONS

- RFID Interrogators
- GSM, CDMA, CDMA2000 Transmitters
- Point-to-Point Wireless Infrastructure Tx
- Image Reject Up-Converters for Cellular Bands
- Low-Noise Variable Phase-Shifter for 620MHz to 1100MHz Local Oscillator Signals

DESCRIPTION

The LT[®]5571 is a direct I/Q modulator designed for high performance wireless applications, including wireless infrastructure. It allows direct modulation of an RF signal using differential baseband I and Q signals. It supports RFID, GSM, EDGE, CDMA, CDMA2000, and other systems. It may also be configured as an image reject upconverting mixer by applying 90° phase-shifted signals to the I and Q inputs. The high impedance I/Q baseband inputs consist of voltage-to-current converters that in turn drive double-balanced mixers. The outputs of these mixers are summed and applied to an on-chip RF transformer, which converts the differential mixer signals to a 50Ω single-ended output. The four balanced I and Q baseband input ports are intended for DC-coupling from a source with a common-mode voltage at about 0.5V . The LO path consists of an LO buffer with single-ended input, and precision quadrature generators that produce the LO drive for the mixers. The supply voltage range is 4.5V to 5.25V .

LT, LT, LTC and LTM are registered trademarks of Linear Technology Corporation. All other trademarks are the property of their respective owners.

TYPICAL APPLICATION

Direct Conversion Transmitter Application

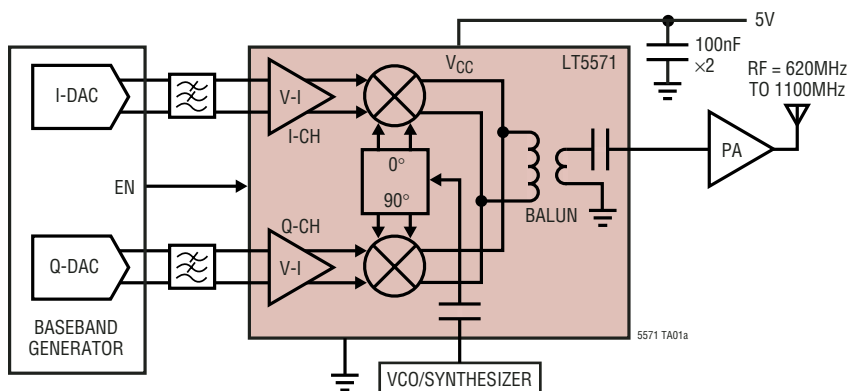

CDMA2000 ACPR, AItCPR and Noise vs RF Output Power at 900MHz for 1 and 3 Carriers

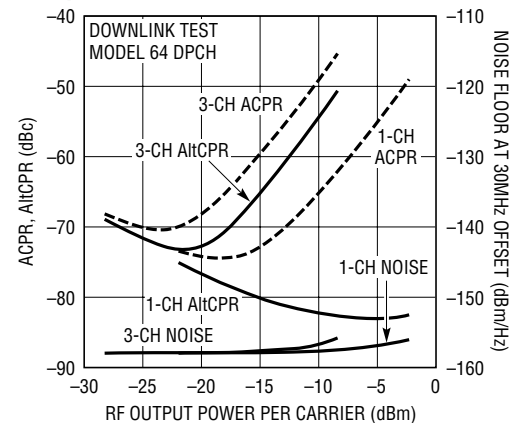

5571 TA01b

5571f

ABSOLUTE MAXIMUM RATINGS

(Note 1)

Supply Voltage	5.5V
Common-Mode Level of BBPI, BBMI and BBPQ, BBMQ	0.6V
Operating Ambient Temperature (Note 2)	-40°C to 85°C
Storage Temperature Range.....	-65°C to 125°C
Voltage on any Pin Not to Exceed.....	-500mV to $V_{CC} + 500mV$

Note: The baseband input pins should not be left floating.

PACKAGE/ORDER INFORMATION

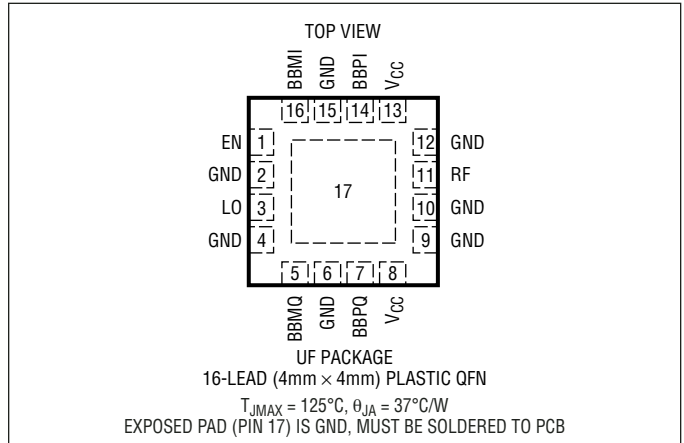

ORDER PART NUMBER	UF PART MARKING
LT5571EUF	5571
Order Options Tape and Reel: Add #TR Lead Free: Add #PBF Lead Free Tape and Reel: Add #TRPBF Lead Free Part Marking: http://www.linear.com/leadfree/	

Consult LTC Marketing for parts specified with wider operating temperature ranges.

ELECTRICAL CHARACTERISTICS

$V_{CC} = 5V$, $EN = High$, $T_A = 25^{\circ}C$, $f_{LO} = 900MHz$, $f_{RF} = 902MHz$, $P_{LO} = 0dBm$. BBPI, BBMI, BBPQ, BBMQ CM input voltage = $0.5V_{DC}$, Baseband Input Frequency = 2MHz, I & Q 90° shifted (upper sideband selection). $P_{RF(OUT)} = -10dBm$, unless otherwise noted. (Note 3)

SYMBOL	PARAMETER	CONDITIONS	MIN	TYP	MAX	UNITS
RF Output (RF)						
f_{RF}	RF Frequency Range	-3dB Bandwidth		0.62 to 1.1		GHz
	RF Frequency Range	-1dB Bandwidth		0.65 to 1.04		GHz
$S_{22, ON}$	RF Output Return Loss	EN = High (Note 6)		12.7		dB
$S_{22, OFF}$	RF Output Return Loss	EN = Low (Note 6)		11.6		dB
NFloor	RF Output Noise Floor	No Input Signal (Note 8)		-159		dBm/Hz
		$P_{OUT} = 4dBm$ (Note 9)		-153.3		dBm/Hz
		$P_{OUT} = 4dBm$ (Note 10)		-152.9		dBm/Hz
G_V	Conversion Voltage Gain	$20 \cdot \log(V_{OUT, 50\Omega} / V_{IN, DIFF, I \text{ or } Q})$		-4.2		dB
P_{OUT}	Absolute Output Power	1V _{P-P} DIFF CW Signal, I and Q		-0.2		dBm
$G_{3LO \text{ vs } LO}$	3 • LO Conversion Gain Difference	(Note 17)		-25.5		dB
OP1dB	Output 1dB Compression	(Note 7)		8.1		dBm
OIP2	Output 2nd Order Intercept	(Notes 13, 14)		63.8		dBm
OIP3	Output 3rd Order Intercept	(Notes 13, 15)		21.7		dBm
IR	Image Rejection	(Note 16)		-53		dBc
LOFT	Carrier Leakage (LO Feedthrough)	EN = High, $P_{LO} = 0dBm$ (Note 16)		-42		dBm
		EN = Low, $P_{LO} = 0dBm$ (Note 16)		-61		dBm

ELECTRICAL CHARACTERISTICS $V_{CC} = 5V$, EN = High, $T_A = 25^\circ C$, $f_{LO} = 900MHz$, $f_{RF} = 902MHz$, $P_{LO} = 0dBm$. BBPI, BBMI, BBPQ, BBMQ CM input voltage = $0.5V_{DC}$, Baseband Input Frequency = 2MHz, I & Q 90° shifted (upper sideband selection). $P_{RF(OUT)} = -10dBm$, unless otherwise noted. (Note 3)

LO Input (LO)

f_{LO}	LO Frequency Range		0.5 to 1.2	GHz
P_{LO}	LO Input Power		-10 0 5	dBm
$S_{11, ON}$	LO Input Return Loss	EN = High (Note 6)	-10.9	dB
$S_{11, OFF}$	LO Input Return Loss	EN = Low (Note 6)	-2.6	dB
NF_{LO}	LO Input Referred Noise Figure	at 900MHz (Note 5)	14.3	dB
G_{LO}	LO to RF Small Signal Gain	at 900MHz (Note 5)	18.5	dB
$IIP3_{LO}$	LO Input 3rd Order Intercept	at 900MHz (Note 5)	-4.8	dBm

Baseband Inputs (BBPI, BBMI, BBPQ, BBMQ)

BW_{BB}	Baseband Bandwidth	-3dB Bandwidth	400	MHz
V_{CMBB}	DC Common-Mode Voltage	Externally Applied (Note 4)	0.5 0.6	V
R_{IN}	Differential Input Resistance		90	k Ω
$I_{DC, IN}$	Baseband Static Input Current	(Note 4)	-24	μA
P_{LO-BB}	Carrier Feedthrough on BB	No Baseband Signal (Note 4)	-42	dBm
IP1dB	Input 1dB Compression Point	Differential Peak-to-Peak (Note 7)	2.9	$V_{P-P,DIFF}$
$\Delta G_{I/Q}$	I/Q Absolute Gain Imbalance		0.013	dB
$\Delta \phi_{I/Q}$	I/Q Absolute Phase Imbalance		0.24	Deg

Power Supply (V_{CC})

V_{CC}	Supply Voltage		4.5 5 5.25	V
$I_{CC(ON)}$	Supply Current	EN = High	97 120	mA
$I_{CC(OFF)}$	Supply Current, Shutdown Mode	EN = 0V	100	μA
t_{ON}	Turn-On Time	EN = Low to High (Note 11)	0.4	μs
t_{OFF}	Turn-Off Time	EN = High to Low (Note 12)	1.4	μs

Enable (EN), Low = Off, High = On

Enable	Input High Voltage Input High Current	EN = High EN = 5V	1 230	V μA
Shutdown	Input Low Voltage	EN = Low	0.5	V

Note 1: Stresses beyond those listed under Absolute Maximum Ratings may cause permanent damage to the device. Exposure to any Absolute Maximum Rating condition for extended periods may affect device reliability and lifetime.

Note 2: Specifications over the -40°C to 85°C temperature range are assured by design, characterization and correlation with statistical process controls.

Note 3: Tests are performed as shown in the configuration of Figure 7.

Note 4: At each of the four baseband inputs BBPI, BBMI, BBPQ and BBMQ.

Note 5: $V(BBPI) - V(BBMI) = 1V_{DC}$, $V(BBPQ) - V(BBMQ) = 1V_{DC}$.

Note 6: Maximum value within -1dB bandwidth.

Note 7: An external coupling capacitor is used in the RF output line.

Note 8: At 20MHz offset from the LO signal frequency.

Note 9: At 20MHz offset from the CW signal frequency.

Note 10: At 5MHz offset from the CW signal frequency.

Note 11: RF power is within 10% of final value.

Note 12: RF power is at least 30dB lower than in the ON state.

Note 13: Baseband is driven by 2MHz and 2.1MHz tones. Drive level is set in such a way that the two resulting RF tones are -10dBm each.

Note 14: IM2 measured at LO frequency + 4.1MHz

Note 15: IM3 measured at LO frequency + 1.9MHz and LO frequency + 2.2MHz.

Note 16: Amplitude average of the characterization data set without image or LO feed-through nulling (unadjusted).

Note 17: The difference in conversion gain between the spurious signal at $f = 3 \cdot LO - BB$ versus the conversion gain at the desired signal at $f = LO + BB$ for $BB = 2MHz$ and $LO = 900MHz$.

TYPICAL PERFORMANCE CHARACTERISTICS $V_{CC} = 5V$, $EN = High$, $T_A = 25^\circ C$, $f_{LO} = 900MHz$, $f_{RF} = 902MHz$, $P_{LO} = 0dBm$. BBPI, BBMI, BBPQ, BBMQ CM input voltage = $0.5V_{DC}$, Baseband Input Frequency $f_{BB} = 2MHz$, I & Q 90° shifted, without image or LO feedthrough nulling. $f_{RF} = f_{BB} + f_{LO}$ (upper sideband selection). $P_{RF(OUT)} = -10dBm$ ($-10dBm/tone$ for 2-tone measurements), unless otherwise noted. (Note 3)

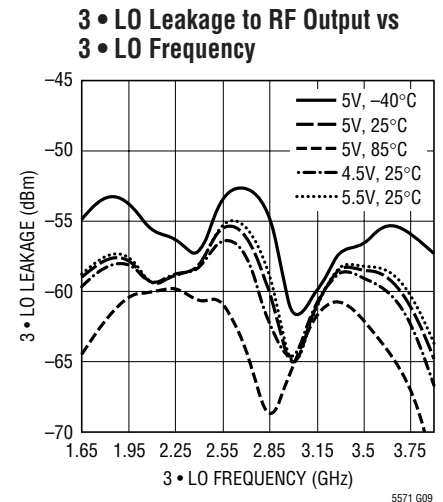
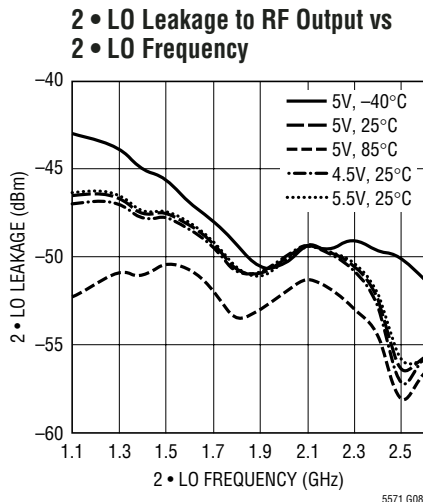
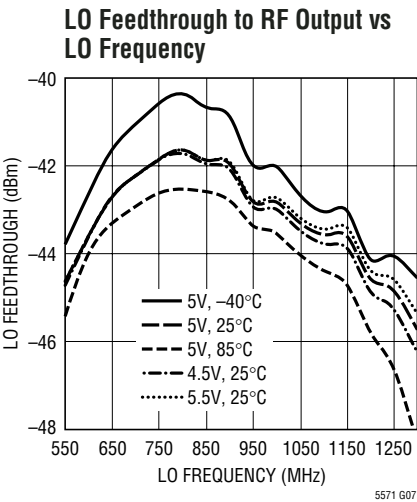
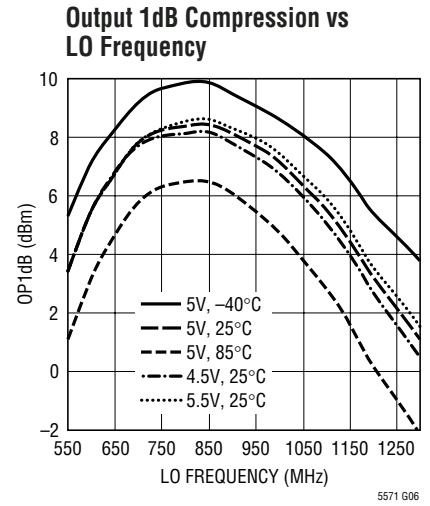
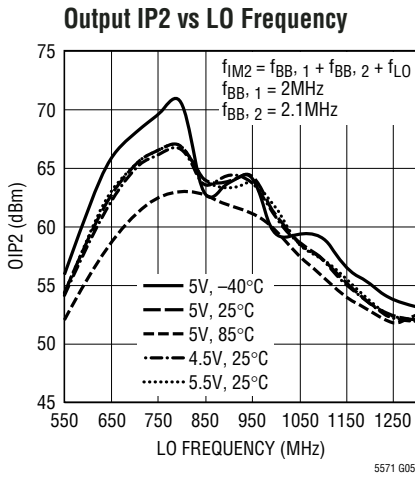
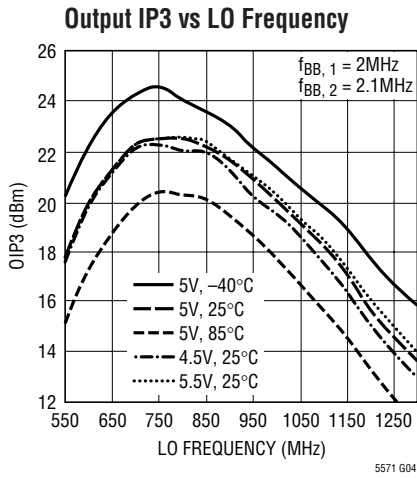
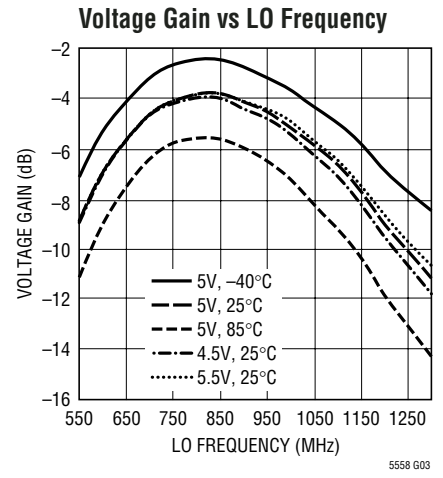
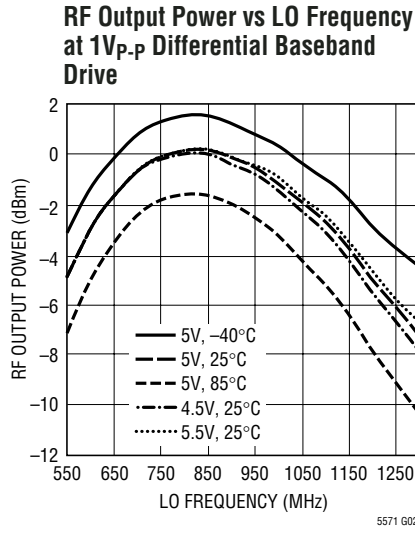
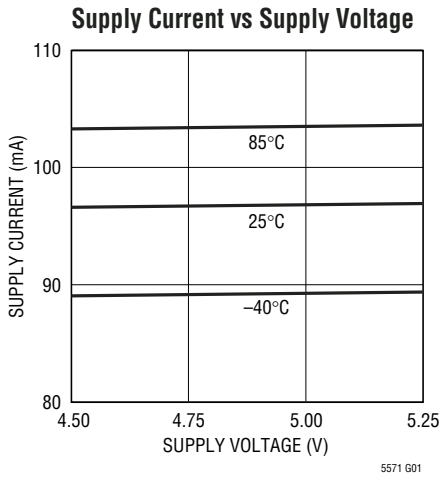

TYPICAL PERFORMANCE CHARACTERISTICS $V_{CC} = 5V$, $EN = High$, $T_A = 25^\circ C$, $f_{LO} = 900MHz$, $f_{RF} = 902MHz$, $P_{LO} = 0dBm$. BBPI, BBMI, BBPQ, BBMQ CM input voltage = $0.5V_{DC}$, Baseband Input Frequency $f_{BB} = 2MHz$, I & Q 90° shifted, without image or LO feedthrough nulling. $f_{RF} = f_{BB} + f_{LO}$ (upper sideband selection). $P_{RF(OUT)} = -10dBm$ (-10dBm/tone for 2-tone measurements), unless otherwise noted. (Note 3)

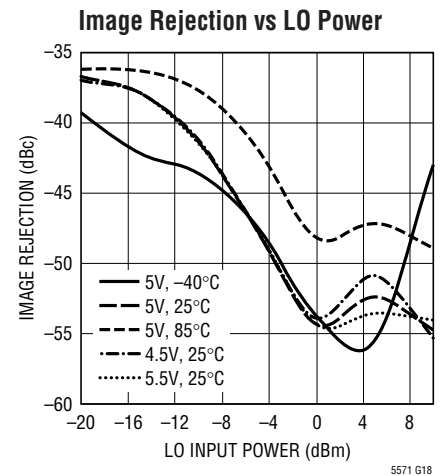
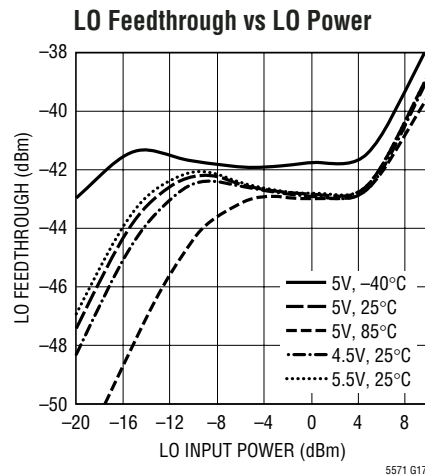
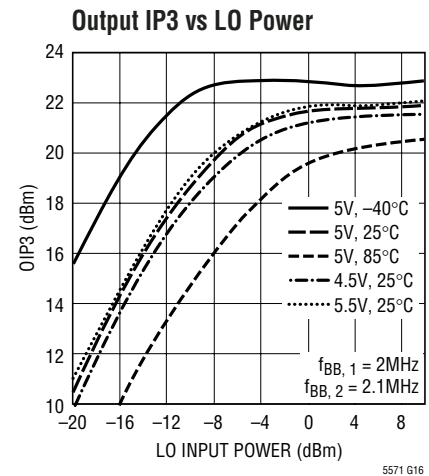
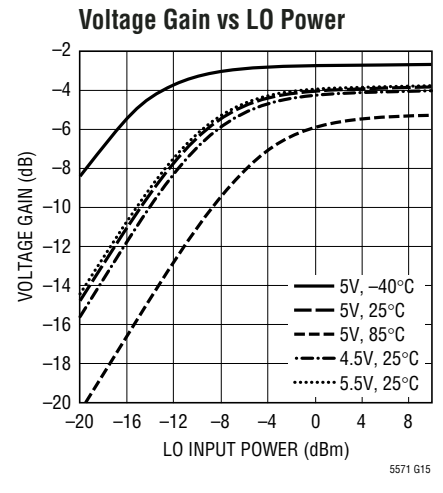
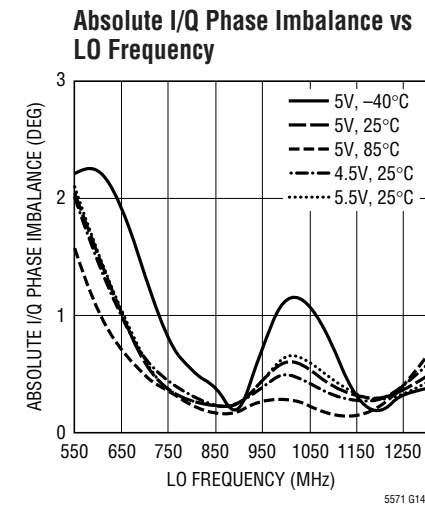
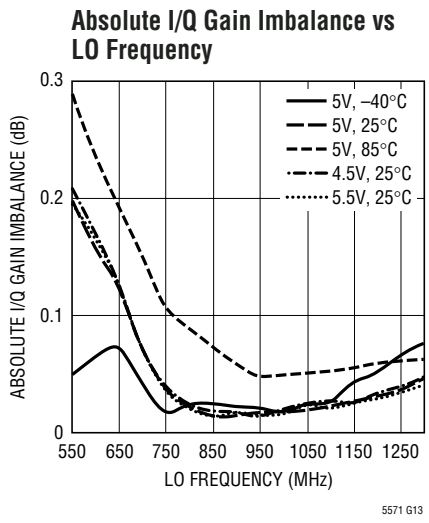
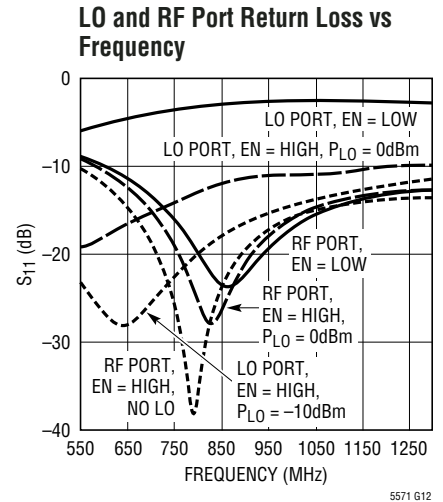
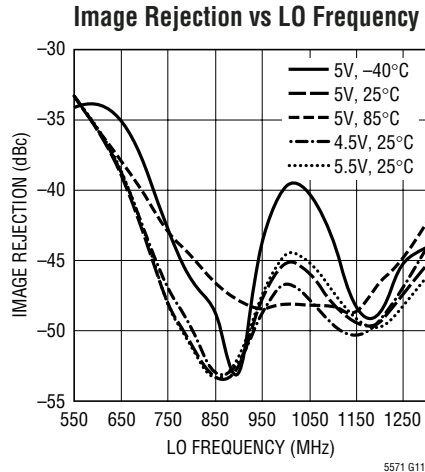
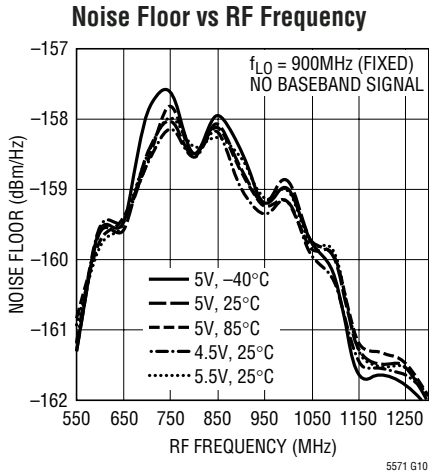

TYPICAL PERFORMANCE CHARACTERISTICS $V_{CC} = 5V$, $EN = High$, $T_A = 25^\circ C$, $f_{LO} = 900MHz$, $f_{RF} = 902MHz$, $P_{LO} = 0dBm$. BBPI, BBMI, BBPQ, BBMQ CM input voltage = $0.5V_{DC}$, Baseband Input Frequency $f_{BB} = 2MHz$, I & Q 90° shifted, without image or LO feedthrough nulling. $f_{RF} = f_{BB} + f_{LO}$ (upper sideband selection). $P_{RF(OUT)} = -10dBm$ (-10dBm/tone for 2-tone measurements), unless otherwise noted. (Note 3)

RF CW Output Power, HD2 and HD3 vs CW Baseband Voltage and Temperature

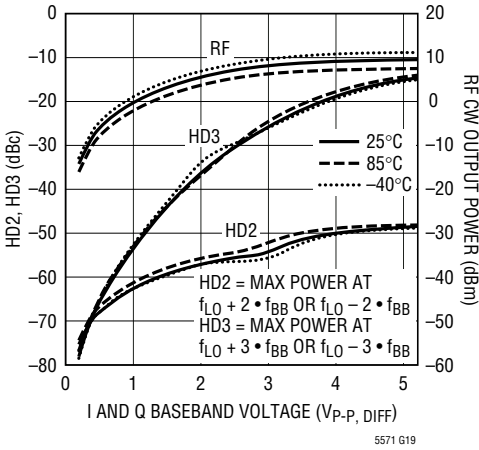

RF CW Output Power, HD2 and HD3 vs CW Baseband Voltage and Supply Voltage

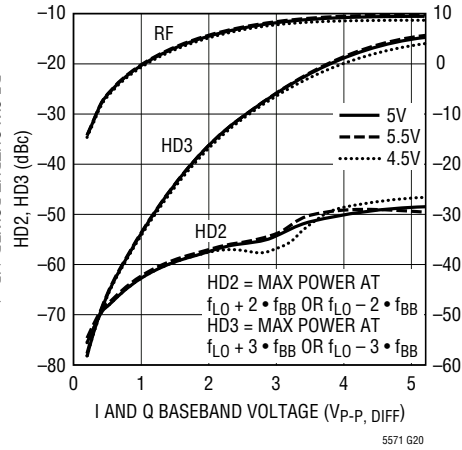

LO Feedthrough to RF Output vs CW Baseband Voltage

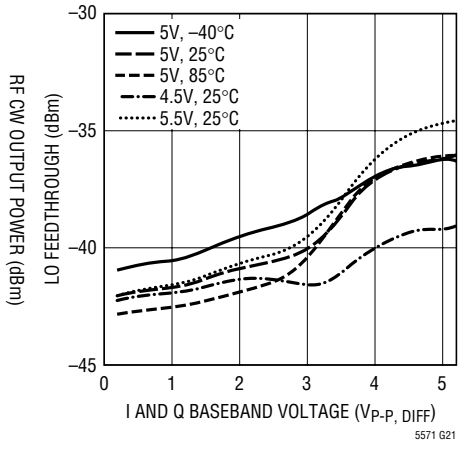
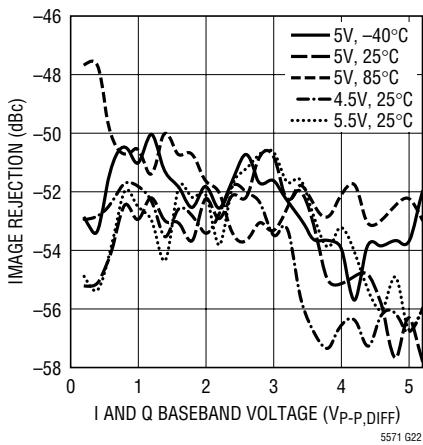
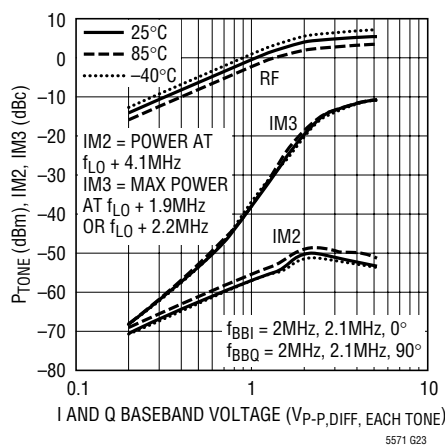

Image Rejection vs CW Baseband Voltage



RF Two-Tone Power (Each Tone), IM2 and IM3 vs Baseband Voltage and Temperature



RF Two-Tone Power (Each Tone), IM2 and IM3 vs Baseband Voltage and Supply Voltage

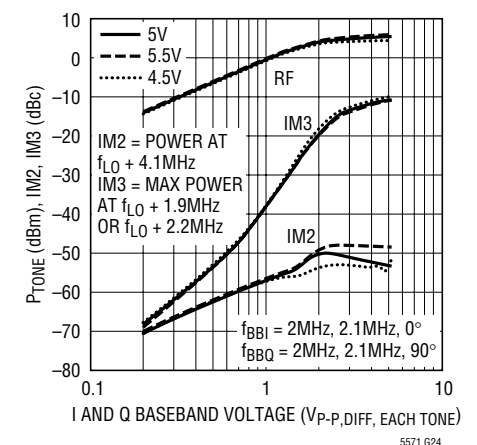

Voltage Gain Distribution

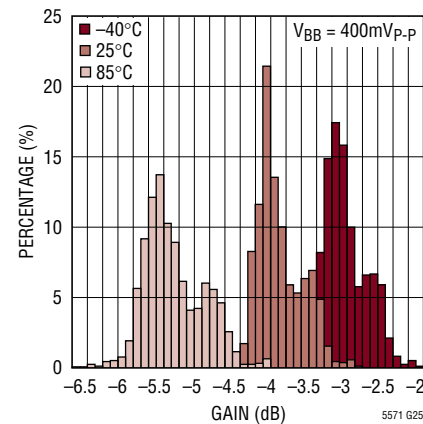

Noise Floor Distribution (no RF)

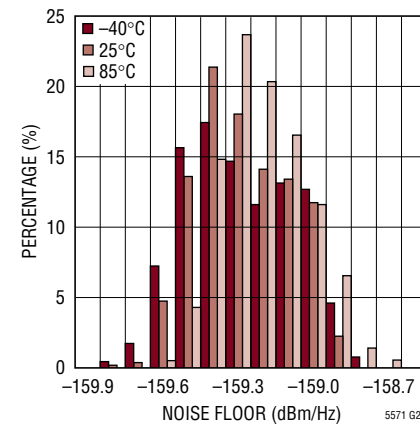

LO Leakage Distribution

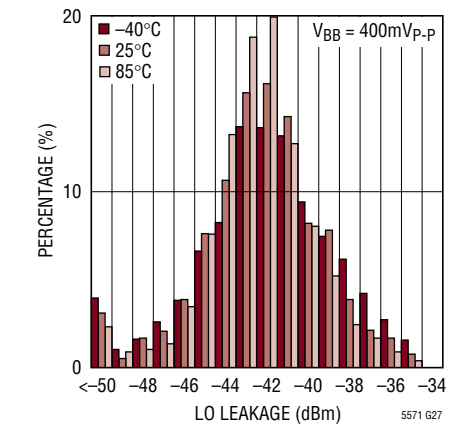

TYPICAL PERFORMANCE CHARACTERISTICS

$V_{CC} = 5V$, $EN = High$, $T_A = 25^{\circ}C$, $f_{LO} = 900MHz$, $f_{RF} = 902MHz$, $P_{LO} = 0dBm$. $BBPI$, $BBMI$, $BBPQ$, $BBMQ$ CM input voltage = $0.5V_{DC}$, Baseband Input Frequency $f_{BB} = 2MHz$, I & Q 90° shifted, without image or LO feedthrough nulling. $f_{RF} = f_{BB} + f_{LO}$ (upper sideband selection). $P_{RF(OUT)} = -10dBm$ ($-10dBm/$ tone for 2-tone measurements), unless otherwise noted. (Note 3)

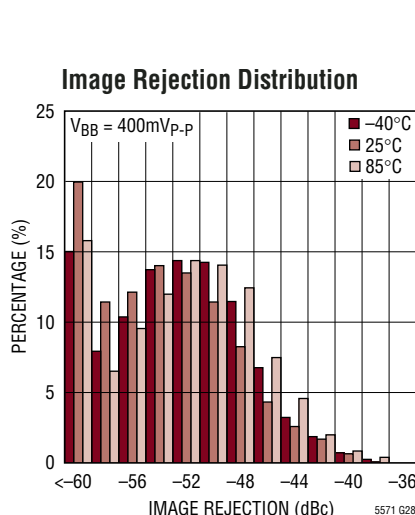

LO Feedthrough and Image Rejection vs Temperature After Calibration at 25°C

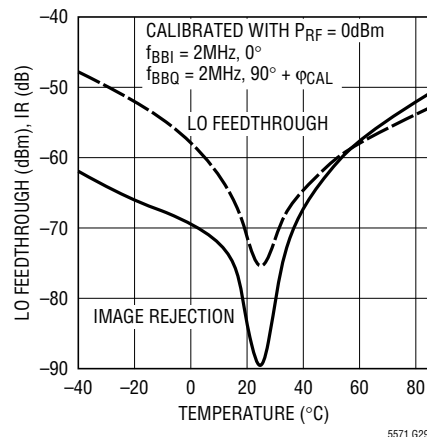

PIN FUNCTIONS

EN (Pin 1): Enable Input. When the Enable pin voltage is higher than 1V, the IC is turned on. When the Enable voltage is less than 0.5V or if the pin is disconnected, the IC is turned off. The voltage on the Enable pin should never exceed V_{CC} by more than 0.5V, in order to avoid possible damage to the chip.

GND (Pins 2, 4, 6, 9, 10, 12, 15, 17): Ground. Pins 6, 9, 15 and the Exposed Pad 17 are connected to each other internally. Pins 2 and 4 are connected to each other internally and function as the ground return for the LO signal. Pins 10 and 12 are connected to each other internally and function as the ground return for the on-chip RF balun. For best RF performance, Pins 2, 4, 6, 9, 10, 12, 15 and the Exposed Pad, Pin 17, should be connected to the printed circuit board ground plane.

LO (Pin 3): LO Input. The LO input is an AC-coupled single-ended input with approximately 50Ω input impedance at RF frequencies. Externally applied DC voltage should be within the range $-0.5V$ to $(V_{CC} + 0.5V)$ in order to avoid turning on ESD protection diodes.

BBPQ, BBMQ (Pins 7, 5): Baseband inputs for the Q-channel with about $90k\Omega$ differential input impedance. These pins should be externally biased at about 0.5V. Applied common mode voltage must stay below 0.6V.

V_{CC} (Pins 8, 13): Power Supply. Pins 8 and 13 are connected to each other internally. $0.1\mu F$ capacitors are recommended for decoupling to ground on each of these pins.

RF (Pin 11): RF Output. The RF output is an AC-coupled single-ended output with approximately 50Ω output impedance at RF frequencies. Externally applied DC voltage should be within the range $-0.5V$ to $(V_{CC} + 0.5V)$ in order to avoid turning on ESD protection diodes.

BBPI, BBMI (Pins 14, 16): Baseband inputs for the I-channel with about $90k\Omega$ differential input impedance. These pins should be externally biased at about 0.5V. Applied common mode voltage must stay below 0.6V.

Exposed Pad (Pin 17): Ground. The Exposed Pad must be soldered to the PCB.

BLOCK DIAGRAM

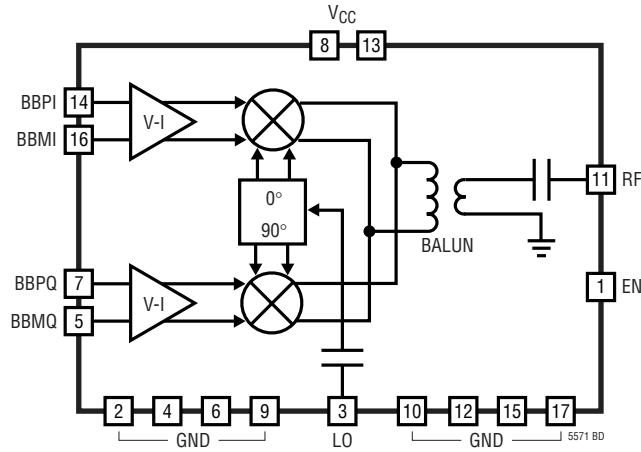

APPLICATIONS INFORMATION

The LT5571 consists of I and Q input differential voltage-to-current converters, I and Q up-conversion mixers, an RF signal combiner/balun, an LO quadrature phase generator and LO buffers.

External I and Q baseband signals are applied to the differential baseband input pins, BBPI, BBMI, and BBPQ, BBMQ. These voltage signals are converted to currents and translated to RF frequency by means of double-balanced up-converting mixers. The mixer outputs are combined in an RF output balun, which also transforms the output impedance to 50Ω. The center frequency of the resulting RF signal is equal to the LO signal frequency. The LO input drives a phase shifter which splits the LO signal into in-phase and quadrature LO signals. These LO signals are then applied to on-chip buffers which drive the up-conversion mixers. Both the LO input and RF output are single-ended, 50Ω-matched and AC-coupled.

Baseband Interface

The baseband inputs (BBPI, BBMI), (BBPQ, BBMQ) present a differential input impedance of about 90kΩ. At each of the four baseband inputs, a capacitor of 1.8pF to ground and a PNP emitter follower is incorporated (see Figure 1), which limits the baseband bandwidth to approximately 200MHz (−1dB point), if driven by a 50Ω source. The circuit is optimized for a common mode voltage of 0.5V which should be externally applied. The baseband input

pins should not be left floating because the internal PNP's base current will pull the common mode voltage higher than the 0.6V limit. This condition may damage the part. The PNP's base current is about 24μA in normal operation. On the LT5571 demo board, external 50Ω resistors to ground are added to each baseband input to prevent this condition and to serve as a termination resistance for the baseband connections.

It is recommended that the I/Q signals be DC-coupled to the LT5571. An applied common mode voltage level at the I and Q inputs of about 0.5V will maximize the LT5571's dynamic range. Some I/Q generators allow setting the common mode voltage independently. For a 0.5V common mode voltage setting, the common-mode voltage of those generators must be set to 0.5V to create the desired 0.5V bias, when an external 50Ω is present in the setup (See Figure 2).

The part should be driven differentially; otherwise, the even-order distortion products will degrade the overall linearity severely. Typically, a DAC will be the signal source for the LT5571. A reconstruction filter should be placed between the DAC output and the LT5571's baseband inputs.

In Figure 3 a typical baseband interface is shown, including a fifth-order low-pass ladder filter. For each baseband pin, a 0 to 1V swing is developed corresponding to a DAC output current of 0mA to 20mA. The maximum sinusoidal single side-band RF output power is about +5.8dBm for

5571f

APPLICATIONS INFORMATION

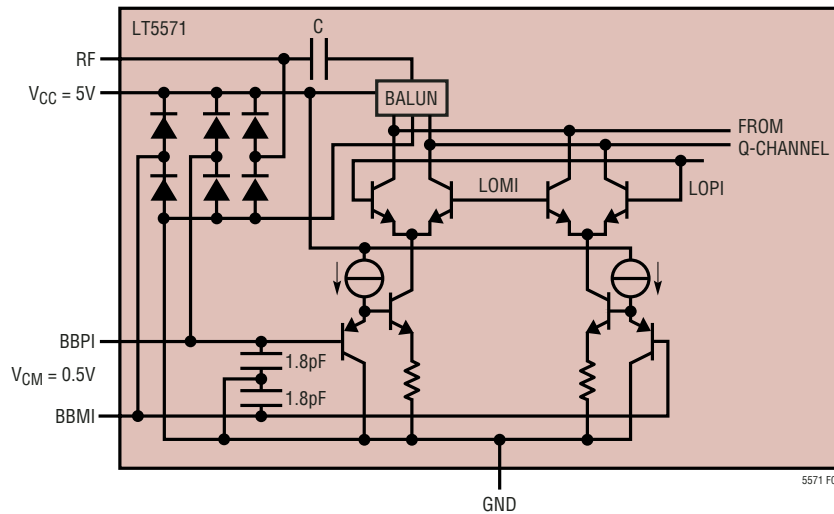

Figure 1. Simplified Circuit Schematic of the LT5571 (Only I-Half is Drawn)

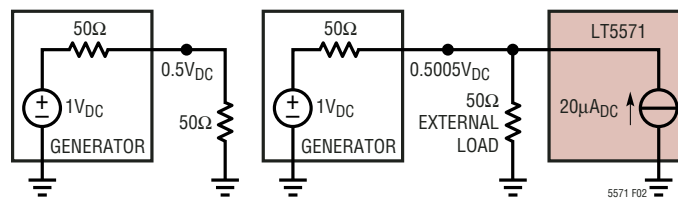

Figure 2. DC Voltage Levels for a Generator Programmed at 0.5V_{DC} for a 50Ω Load Without and with the LT5571 as a Load

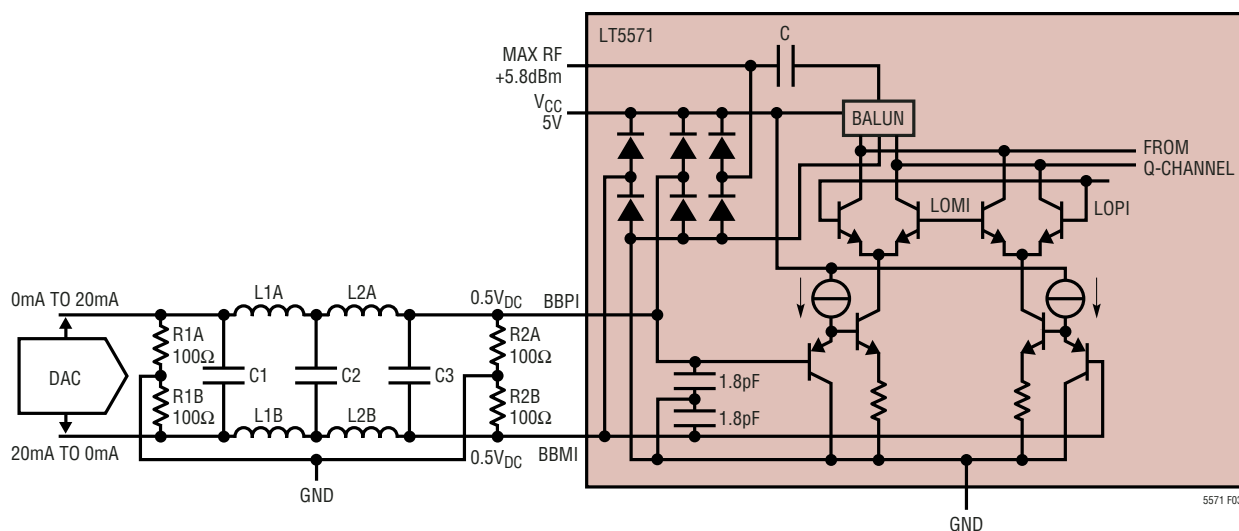

Figure 3. LT5571 Baseband Interface with 5th Order Filter and 0.5V_{CM} DAC (Only I Channel is Shown)

APPLICATIONS INFORMATION

Table 1. Typical Performance Characteristics vs V_{CM} for $f_{LO} = 900\text{MHz}$, $P_{LO} = 0\text{dBm}$

V_{CM} (V)	I_{CC} (mA)	G_V (dB)	OP1dB (dBm)	OIP2 (dBm)	OIP3 (dBm)	NFloor (dBm/Hz)	LOFT (dBm)	IR (dBc)
0.1	55.3	-4.5	-1.5	53.4	9.2	-163.6	-53.6	37.0
0.2	65.3	-3.9	2.0	51.7	11.2	-161.8	-50.3	40.4
0.25	70.3	-3.7	3.4	51.9	13.3	-161.2	-49.0	43.5
0.3	75.7	-3.6	4.5	52.1	15.6	-160.5	-47.7	43.9
0.4	86.4	-3.5	6.3	53.1	18.7	-159.6	-45.3	45.1
0.5	97.1	-3.6	7.9	53.0	20.6	-158.7	-43.1	45.4
0.6	108.1	-3.7	8.4	53.7	22.1	-157.9	-41.2	45.6

full 0V to 1V swing on each baseband input ($2V_{P-P,DIFF}$). This maximum RF output level is limited by the $0.5V_{PEAK}$ maximum baseband swing possible for a $0.5V_{DC}$ common-mode voltage level (assuming no negative supply bias voltage is available).

It is possible to bias the LT5571 to a common mode voltage level other than 0.5V. Table 1 shows the typical performance for different common mode voltages.

LO Section

The internal LO input amplifier performs single-ended to differential conversion of the LO input signal. Figure 4 shows the equivalent circuit schematic of the LO input.

The internal differential LO signal is split into in-phase and quadrature (90° phase shifted) signals to drive LO buffer sections. These buffers drive the double balanced I and Q mixers. The phase relationship between the LO input and the internal in-phase LO and quadrature LO signals is fixed, and is independent of start-up conditions. The phase shifters are designed to deliver accurate quadrature signals for an LO frequency near 900MHz. For frequencies significantly below 750MHz or above 1100MHz, the quadrature accuracy will diminish, causing the image rejection to degrade. The LO pin input impedance is about

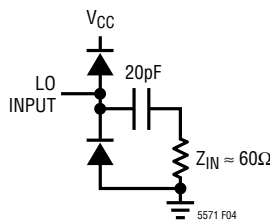

Figure 4. Equivalent Circuit Schematic of the LO Input

50Ω , and the recommended LO input power window is -2dBm to 2dBm . For $P_{LO} < -2\text{dBm}$ input power, the gain, OIP2, OIP3, dynamic-range (in dBc/Hz) and image rejection will degrade, especially at $T_A = 85^\circ\text{C}$.

Harmonics present on the LO signal can degrade the image rejection, because they introduce a small excess phase shift in the internal phase splitter. For the second (at 1.8GHz) and third harmonics (at 2.7GHz) at -20dBc level, the introduced signal at the image frequency is about -61dBc or lower, corresponding to an excess phase shift much less than 1 degree. For the second and third harmonics at -10dBc , still the introduced signal at the image frequency is about -51dBc . Higher harmonics than the third will have less impact. The LO return loss typically will be better than 11dB over the 750MHz to 1GHz range. Table 2 shows the LO port input impedance vs frequency.

Table 2. LO Port Input Impedance vs Frequency for EN = High and $P_{LO} = 0\text{dBm}$

FREQUENCY (MHz)	INPUT IMPEDANCE (Ω)	S_{11}	
		Mag	Angle
500	$47.2 + j11.7$	0.123	97
600	$58.4 + j8.3$	0.108	40
700	$65.0 - j0.6$	0.131	-2
800	$66.1 - j12.2$	0.173	-31
900	$60.7 - j22.5$	0.221	-53
1000	$53.3 - j25.1$	0.239	-69
1100	$48.4 - j25.1$	0.248	-79
1200	$42.7 - j26.4$	0.285	-89

The return loss S_{11} on the LO port can be improved at lower frequencies by adding a shunt capacitor. The input impedance of the LO port is different if the part is in shut-down mode. The LO input impedance for EN = Low is given in Table 3.

APPLICATIONS INFORMATION

Table 3. LO Port Input Impedance vs Frequency for EN = Low and $P_{LO} = 0\text{dBm}$

FREQUENCY (MHz)	INPUT IMPEDANCE (Ω)	S_{11}	
		Mag	Angle
500	35.6 + j42.1	0.467	83
600	65.5 + j70.1	0.531	46
700	163 + j76.3	0.602	14
800	188 – j95.2	0.654	–13
900	72.9 – j114	0.692	–36
1000	34.3 – j83.5	0.715	–56
1100	21.6 – j63.3	0.726	–73
1200	16.4 – j50.5	0.727	–86

RF Section

After up-conversion, the RF outputs of the I and Q mixers are combined. An on-chip balun performs internal differential to single-ended output conversion, while transforming the output signal impedance to 50Ω . Table 4 shows the RF port output impedance vs frequency.

Table 4. RF Port Output Impedance vs Frequency for EN = High and $P_{LO} = 0\text{dBm}$

FREQUENCY (MHz)	OUTPUT IMPEDANCE (Ω)	S_{22}	
		Mag	Angle
500	22.2 + j5.2	0.390	165
600	28.4 + j11.7	0.311	143
700	38.8 + j14.3	0.202	119
800	49.4 + j6.8	0.068	91
900	49.4 – j5.8	0.058	–92
1000	42.7 – j11.7	0.149	–115
1100	36.9 – j12.6	0.207	–128
1200	33.2 – j11.3	0.241	–138

The RF output S_{22} with no LO power applied is given in Table 5.

Table 5. RF Port Output Impedance vs Frequency for EN = High and No LO Power Applied

FREQUENCY (MHz)	OUTPUT IMPEDANCE (Ω)	S_{22}	
		Mag	Angle
500	22.9 + j5.3	0.377	165
600	30.0 + j11.2	0.283	143
700	40.6 + j11.2	0.160	123
800	47.3 + j1.9	0.034	145
900	44.2 – j7.4	0.099	–123
1000	38.4 – j10.4	0.175	–131
1100	34.2 – j10.2	0.221	–140
1200	31.7 – j8.7	0.246	–148

For EN = Low the S_{22} is given in Table 6.

Table 6. RF Port Output Impedance vs Frequency for EN = Low

FREQUENCY (MHz)	OUTPUT IMPEDANCE (Ω)	S_{22}	
		Mag	Angle
500	21.5 + j5.0	0.403	166
600	26.9 + j11.8	0.333	144
700	36.5 + j16.0	0.239	120
800	48.8 + j11.2	0.113	89
900	52.8 – j2.2	0.035	–38
1000	46.6 – j11.5	0.123	–99
1100	39.7 – j13.9	0.191	–117
1200	35.0 – j13.0	0.232	–130

To improve S_{22} for lower frequencies, a series capacitor can be added to the RF output. At higher frequencies, a shunt inductor can improve the S_{22} . Figure 5 shows the equivalent circuit schematic of the RF output.

Note that an ESD diode is connected internally from the RF output to ground. For strong output RF signal levels (higher than 3dBm) this ESD diode can degrade the linearity performance if an external 50Ω termination impedance is connected directly to ground. To prevent this, a coupling capacitor can be inserted in the RF output line. This is strongly recommended during 1dB compression measurements.

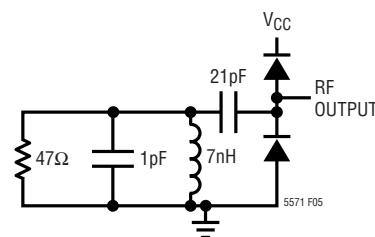

Figure 5. Equivalent Circuit Schematic of the RF Output

Enable Interface

Figure 6 shows a simplified schematic of the EN pin interface. The voltage necessary to turn on the LT5571 is 1V. To disable (shut down) the chip, the enable voltage must be below 0.5V. If the EN pin is not connected, the chip is disabled. This EN = Low condition is guaranteed by the $75k\Omega$ on-chip pull-down resistor.

It is important that the voltage at the EN pin does not exceed V_{CC} by more than 0.5V. If this should occur, the

APPLICATIONS INFORMATION

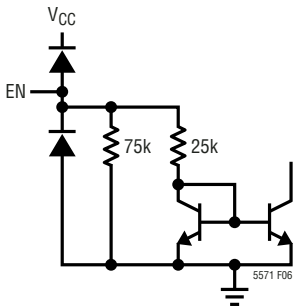

Figure 6. EN Pin Interface

full chip supply current could be sourced through the EN pin ESD protection diodes, which are not designed for this purpose. Damage to the chip may result.

Evaluation Board

Figure 7 shows the evaluation board schematic. A good ground connection is required for the LT5571's Exposed Pad. If this is not done properly, the RF performance will degrade. Additionally, the Exposed Pad provides heat sinking for the part and minimizes the possibility of the chip

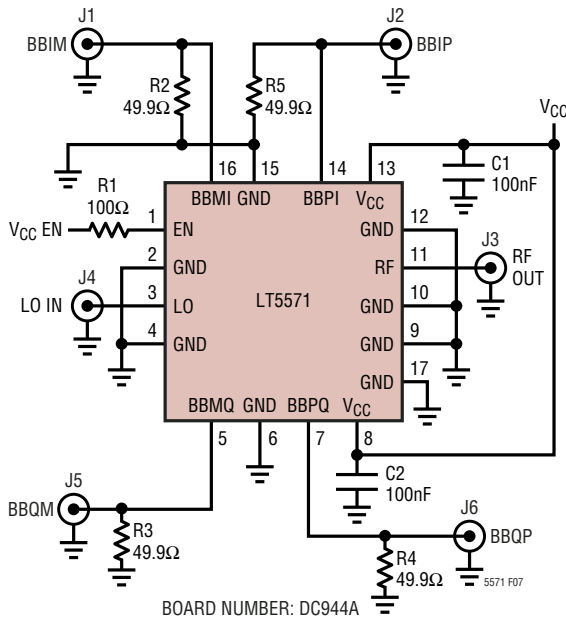

Figure 7. Evaluation Circuit Schematic

overheating. R1 (optional) limits the EN pin current in the event that the EN pin is pulled high while the V_{CC} inputs are low. The application board PCB layouts are shown in Figures 8 and 9.

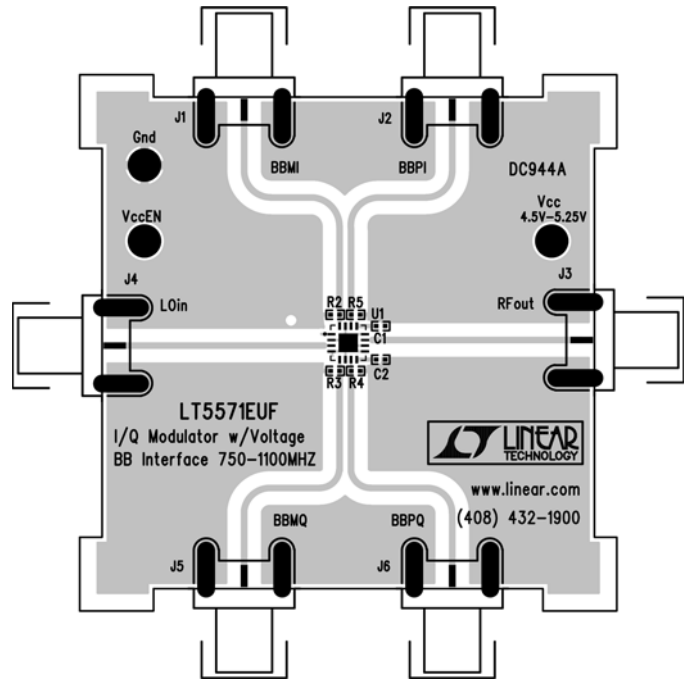

Figure 8. Component Side of Evaluation Board

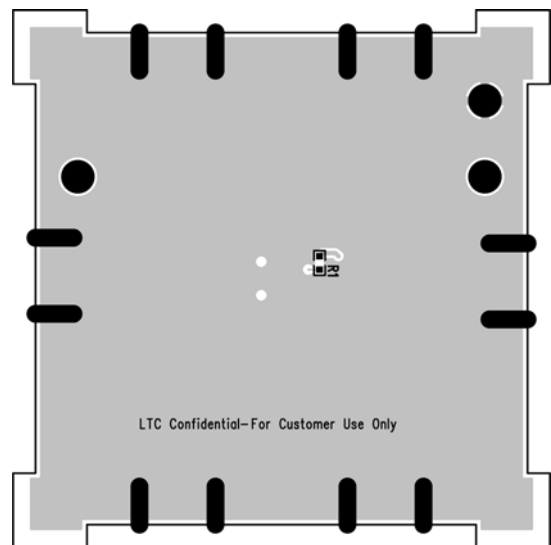

Figure 9. Bottom Side of Evaluation Board

APPLICATIONS INFORMATION

Application Measurements

The LT5571 is recommended for base-station applications using various modulation formats. Figure 10 shows a typical application.

Figure 11 shows the ACPR performance for CDMA2000 using one and three channel modulation. Figures 12 and 13 illustrate the 1- and 3-channel CDMA2000 measurement. To calculate ACPR, a correction is made for the spectrum analyzer's noise floor (Application Note 99).

If the output power is high, the ACPR will be limited by the linearity performance of the part. If the output power is low, the ACPR will be limited by the noise performance of the part. In the middle, an optimum ACPR is obtained.

Because of the LT5571's very high dynamic-range, the test equipment can limit the accuracy of the ACPR measurement. Consult Design Note 375 or the factory for advice on ACPR measurement if needed.

The ACPR performance is sensitive to the amplitude mismatch of the BBIP and BBIM (or BBQP and BBQM) input voltage. This is because a difference in AC voltage amplitude will give rise to a difference in amplitude between the even-order harmonic products generated in the internal V-I converter. As a result, they will not cancel out entirely. Therefore, it is important to keep the amplitudes at the BBIP and BBIM (or BBQP and BBQM) as equal as possible.

LO feedthrough and image rejection performance may be improved by means of a calibration procedure. LO feedthrough is minimized by adjusting the differential DC offsets at the I and the Q baseband inputs. Image rejection can be improved by adjusting the amplitude and phase difference between the I and the Q baseband inputs. The LO feedthrough and Image Rejection can also change as a function of the baseband drive level, as depicted in Figure 14.

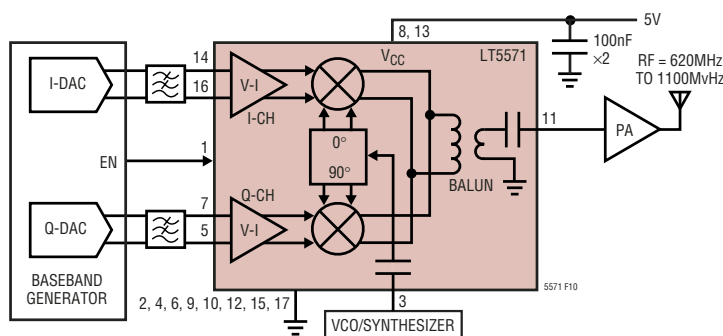

Figure 10. 620MHz to 1.1GHz Direct Conversion Transmitter Application

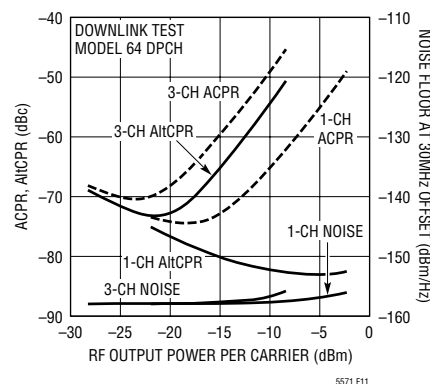

Figure 11. CDMA2000 ACPR, ALTCPR and Noise vs RF Output Power at 900MHz for 1 and 3 Carriers

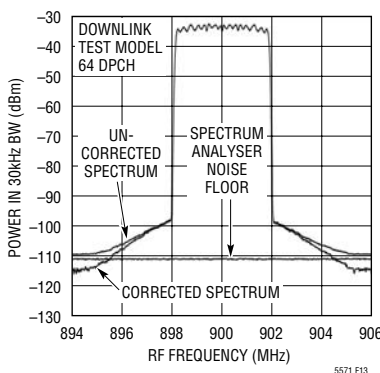
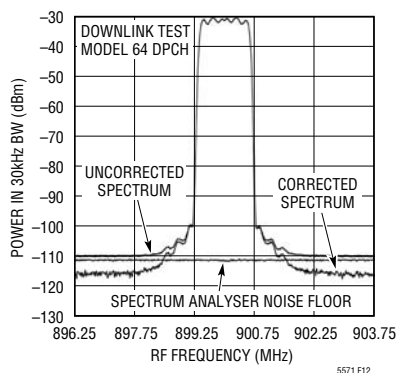

Figure 12. 1-Channel CDMA2000 Spectrum

Figure 13. 3-Channel CDMA2000 Spectrum

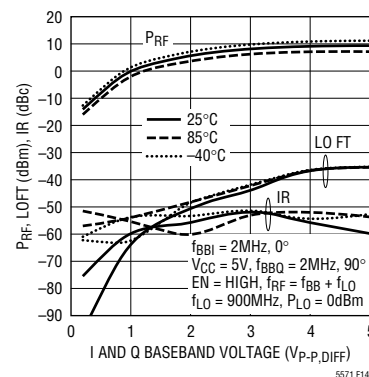

Figure 14. Image Rejection and LO Feedthrough vs Baseband Drive Voltage After Calibration at 25°C

APPLICATIONS INFORMATION

Example: RFID Application

Figure 15 shows the interface between a current drive DAC and the LT5571 for RFID applications. The SSB-ASK mode requires an I/Q modulator to generate the desired spectrum. According to [1], the LT5571 is capable of meeting the “Dense-Interrogator” requirements with reduced supply current. A $V_{CM} = 0.25V$ was chosen in order to save 30mA current, resulting in a modulator supply current of about 73mA. This is achieved by sourcing $5mA_{DC}$ average DAC current into 50Ω resistors R1A and R1B. As anti-aliasing filter, an RCRC filter was chosen using R1A, R1B, C1A, C1B, R2A, R2B, C2A and C2B. This results in a second-order passive low-pass filter with $-3dB$ cutoff at 790kHz. This filter cutoff is chosen high enough that it will not affect

the RFID baseband signals in the fastest mode (TARI = $6.25\mu s$, see [1]) significantly, and at the same time achieving enough alias attenuation while using a 32MHz sampling frequency. The resulting Alt80-CPR (the alias frequency at 897.875MHz falls outside the RF frequency range of Figure 16a) is $-92dBc$ for TARI = $6.25\mu s$. The SSB-ASK output signal spectrum is plotted in Figure 16a, together with the Dense-Interrogator Transmit mask [1] for TARI = $25\mu s$. The corresponding envelope representation is given in Figure 16b. The Alt1-CPR can be increased by using a higher V_{CM} at the cost of extra supply current or a lower baseband drive at the cost of lower RF output power. The center frequency of the channel is chosen at 865.9MHz (“channel 2”), while the LO frequency is chosen at 865.875MHz.

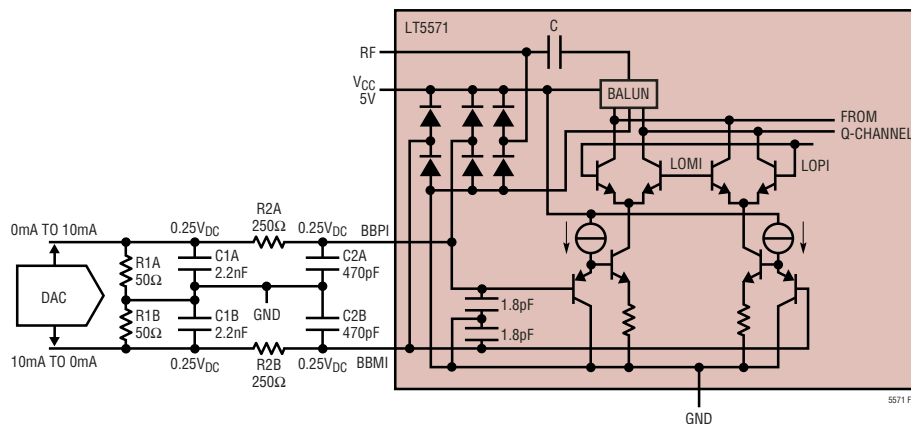

Figure 15. Recommended Baseband Interface for RFID Applications (Only I Channel is Drawn)

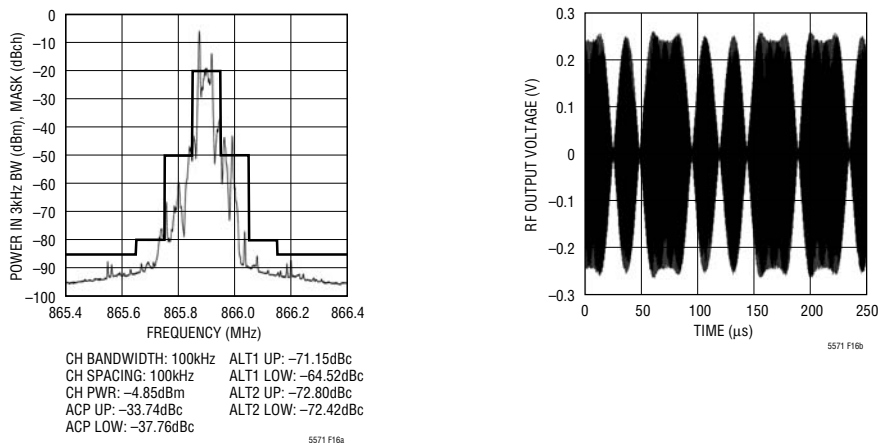
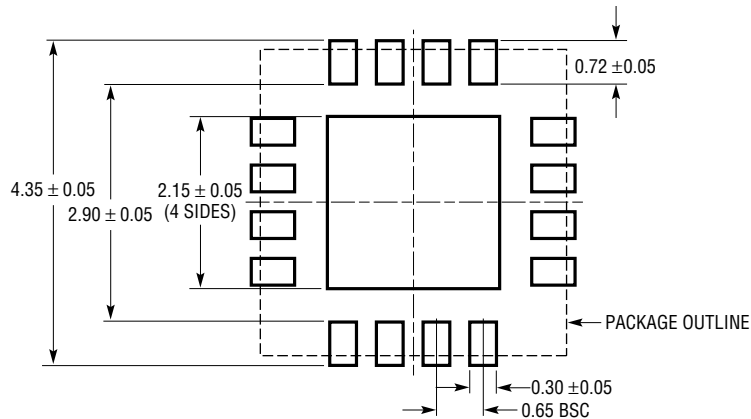

Figure 16a and 16b. RFID SSB-ASK Spectrum with Mask and Corresponding RF Envelope for TARI = $25\mu s$

[1] EPC Radio Frequency Identity Protocols, Class-1 Generation-2 UHF RFID Protocol for Communications at 860MHz – 960MHz, version 1.0.9.

PACKAGE DESCRIPTION

UF Package
16-Lead Plastic QFN (4mm × 4mm)
 (Reference LTC DWG # 05-08-1692)



RECOMMENDED SOLDER PAD PITCH AND DIMENSIONS

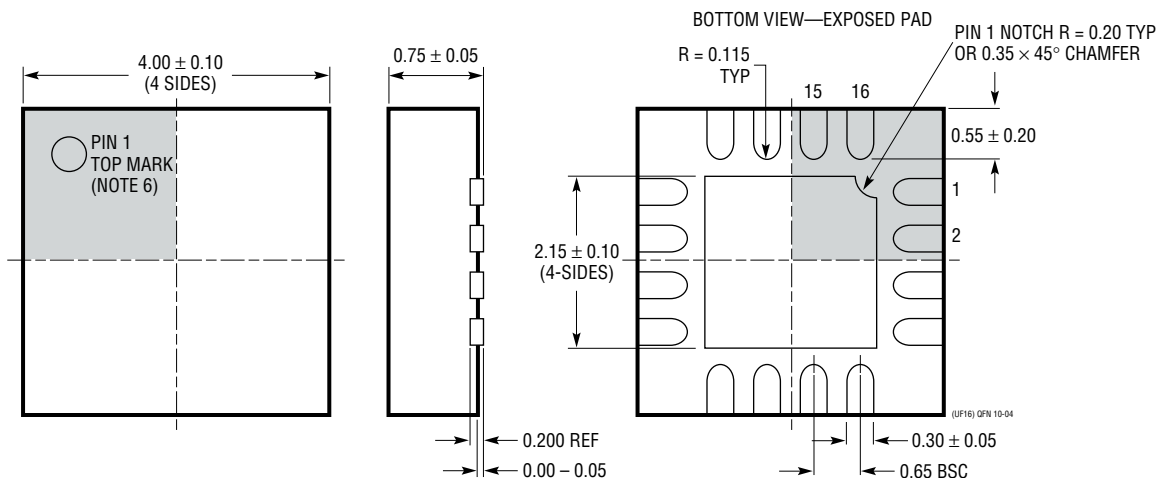

- NOTE:
1. DRAWING CONFORMS TO JEDEC PACKAGE OUTLINE MO-220 VARIATION (WGFC)
 2. DRAWING NOT TO SCALE
 3. ALL DIMENSIONS ARE IN MILLIMETERS
 4. DIMENSIONS OF EXPOSED PAD ON BOTTOM OF PACKAGE DO NOT INCLUDE MOLD FLASH. MOLD FLASH, IF PRESENT, SHALL NOT EXCEED 0.15mm ON ANY SIDE
 5. EXPOSED PAD SHALL BE SOLDER PLATED
 6. SHADED AREA IS ONLY A REFERENCE FOR PIN 1 LOCATION ON THE TOP AND BOTTOM OF PACKAGE

RELATED PARTS

PART NUMBER	DESCRIPTION	COMMENTS
Infrastructure		
LT5514	Ultralow Distortion, IF Amplifier/ADC Driver with Digitally Controlled Gain	850MHz Bandwidth, 47dBm OIP3 at 100MHz, 10.5dB to 33dB Gain Control Range
LT5515	1.5GHz to 2.5GHz Direct Conversion Quadrature Demodulator	20dBm IIP3, Integrated LO Quadrature Generator
LT5516	0.8GHz to 1.5GHz Direct Conversion Quadrature Demodulator	21.5dBm IIP3, Integrated LO Quadrature Generator
LT5517	40MHz to 900MHz Quadrature Demodulator	21dBm IIP3, Integrated LO Quadrature Generator
LT5518	1.5GHz to 2.4GHz High Linearity Direct Quadrature Modulator	22.8dBm OIP3 at 2GHz, -158.2dBm/Hz Noise Floor, 50Ω Single-Ended RF and LO Ports, 4-Channel W-CDMA ACPR = -64dBc at 2.14GHz
LT5519	0.7GHz to 1.4GHz High Linearity Upconverting Mixer	17.1dBm IIP3 at 1GHz, Integrated RF Output Transformer with 50Ω Matching, Single-Ended LO and RF Ports Operation
LT5520	1.3GHz to 2.3GHz High Linearity Upconverting Mixer	15.9dBm IIP3 at 1.9GHz, Integrated RF Output Transformer with 50Ω Matching, Single-Ended LO and RF Ports Operation
LT5521	10MHz to 3700MHz High Linearity Upconverting Mixer	24.2dBm IIP3 at 1.95GHz, NF = 12.5dB, 3.15V to 5.25V Supply, Single-Ended LO Port Operation
LT5522	600MHz to 2.7GHz High Signal Level Downconverting Mixer	4.5V to 5.25V Supply, 25dBm IIP3 at 900MHz, NF = 12.5dB, 50Ω Single-Ended RF and LO Ports
LT5524	Low Power, Low Distortion ADC Driver with Digitally Programmable Gain	450MHz Bandwidth, 40dBm OIP3, 4.5dB to 27dB Gain Control
LT5525	High Linearity, Low Power Downconverting Mixer	Single-Ended 50Ω RF and LO Ports, 17.6dBm IIP3 at 1900MHz, I _{CC} = 28mA
LT5526	High Linearity, Low Power Downconverting Mixer	3V to 5.3V Supply, 16.5dBm IIP3, 100kHz to 2GHz RF, NF = 11dB, I _{CC} = 28mA, -65dBm LO-RF Leakage
LT5527	400MHz to 3.7GHz High Signal Level Downconverting Mixer	IIP3 = 23.5dBm and NF = 12.5dBm at 1900MHz, 4.5V to 5.25V Supply, I _{CC} = 78mA, Conversion Gain = 2dB.
LT5528	1.5GHz to 2.4GHz High Linearity Direct Quadrature Modulator	21.8dBm OIP3 at 2GHz, -159.3dBm/Hz Noise Floor, 50Ω, 0.5V _{DC} Baseband Interface, 4-Channel W-CDMA ACPR = -66dBc at 2.14GHz
LT5558	600MHz to 1100MHz High Linearity Direct Quadrature Modulator	22.4dBm OIP3 at 900MHz, -158dBm/Hz Noise Floor, 3kΩ, 2.1V _{DC} Baseband Interface, 3-Ch CDMA2000 ACPR = -70.4dBc at 900MHz
LT5560	Ultra-Low Power Active Mixer	10mA Supply Current, 10dBm IIP3, 10dB NF, Usable as Up- or Down-Converter.
LT5568	700MHz to 1050MHz High Linearity Direct Quadrature Modulator	22.9dBm OIP3 at 850MHz, -160.3dBm/Hz Noise Floor, 50Ω, 0.5V _{DC} Baseband Interface, 3-Ch CDMA2000 ACPR = -71.4dBc at 850MHz
LT5572	1.5GHz to 2.5GHz High Linearity Direct Quadrature Modulator	21.6dBm OIP3 at 2GHz, -158.6dBm/Hz Noise Floor, High-Ohmic 0.5V _{DC} Baseband Interface, 4-Ch W-CDMA ACPR = -67.7dBc at 2.14GHz
RF Power Detectors		
LTC®5505	RF Power Detectors with >40dB Dynamic Range	300MHz to 3GHz, Temperature Compensated, 2.7V to 6V Supply
LTC5507	100kHz to 1000MHz RF Power Detector	100kHz to 1GHz, Temperature Compensated, 2.7V to 6V Supply
LTC5508	300MHz to 7GHz RF Power Detector	44dB Dynamic Range, Temperature Compensated, SC70 Package
LTC5509	300MHz to 3GHz RF Power Detector	36dB Dynamic Range, Low Power Consumption, SC70 Package
LTC5530	300MHz to 7GHz Precision RF Power Detector	Precision V _{OUT} Offset Control, Shutdown, Adjustable Gain
LTC5531	300MHz to 7GHz Precision RF Power Detector	Precision V _{OUT} Offset Control, Shutdown, Adjustable Offset
LTC5532	300MHz to 7GHz Precision RF Power Detector	Precision V _{OUT} Offset Control, Adjustable Gain and Offset
LT5534	50MHz to 3GHz Log RF Power Detector with 60dB Dynamic Range	±1dB Output Variation over Temperature, 38ns Response Time, Log Linear Response
LTC5536	Precision 600MHz to 7GHz RF Power Detector with Fast Comparator Output	25ns Response Time, Comparator Reference Input, Latch Enable Input, -26dBm to +12dBm Input Range
LT5537	Wide Dynamic Range Log RF/IF Detector	Low Frequency to 1GHz, 83dB Log Linear Dynamic Range