

DESCRIPTION

Demonstration circuit 968A-A is isolated input to high current output 1/8th Brick footprint converter featuring the LT[®]1952 switching controller. The DC968 converts isolated 36V to 75V input to 3.3V output and provides over 30A of output current. The converter operates at 300kHz with efficiency greater than 91%. The DC968 can be easily modified to generate output voltages in the range from 0.6V to 28V. The output currents are limited by total output power of up to 200W. The other available versions of DC968A are:

DC968A-B 18-36Vin to 5V@20A

DC968A-C 36-75Vin to 12V@12A

DC968A-D 36-75Vin to 28V@4A

Also, the DC968 can be modified for other input voltages like 8V-36V, 18V-75V, 44V-52V, and so on. The wider input voltage range will decrease

the converter efficiency. Therefore, narrow input voltage range will be more desirable.

The DC968 circuit features soft-start which prevents output voltage overshoot on startup or when recovering from overload condition.

The DC968 has precise over-current protection circuit that allows for continuous operation under short circuit conditions. The low power dissipation under short circuit conditions insures high reliability even during short circuits.

The LT1952 can be synchronized to an external clock of up to 400kHz. Please refer to LT1952 data sheet for design details and applications information.

Design files for this circuit board are available. Call the LTC factory.

LT is a trademark of Linear Technology Corporation

Table 1. Performance Summary

PARAMETER	CONDITION	VALUE
Minimum Input Voltage	I _{OUT} = 0A to 30A	36V
Maximum Input Voltage	I _{OUT} = 0A to 30A	75V
V _{OUT}	V _{IN} = 36V to 75V, I _{OUT} = 0A to 30A	3.3V ±3%
Typical Output Ripple V _{OUT}	V _{IN} = 36V to 75V, I _{OUT} = 0A to 30A	50mV _{P-P}
Nominal Switching Frequency		300kHz

QUICK START PROCEDURE

Demonstration circuit 968 is easy to set up to evaluate the performance of LT1952 circuit. **Refer to Figure 1 for proper measurement equipment setup** and follow the procedure below:

NOTE:When measuring the input or output voltage ripple, care must be taken to avoid a long ground lead on the oscilloscope probe. Measure the input or output voltage ripple by touching the probe tip directly across the Vin or Vout and GND terminals. See Figure 2. for proper scope probe technique.

QUICK START GUIDE FOR DEMONSTRATION CIRCUIT 968A-A ISOLATED DC/DC POWER CONVERTER

1. With power off, connect the input power supply to Vin and GND. Make sure that the input power supply has sufficient current rating at minimum input voltage for the required output load.
2. Turn on the power at the input.
NOTE: Make sure that the input voltage does not exceed 75V.
3. Check for the proper output voltage.
Vout = 3.3V.
4. Once the proper output voltage is established, adjust the load within the operating range and observe the output voltage regulation, ripple voltage, efficiency and other parameters.
5. The DC968 is equipped with an output capacitor CSYS (470uF) that approximates typical system rail capacitance. If system board already has capacitance of similar value CSYS can be removed.

If there is no output, temporarily disconnect the load to make sure that the load is not set too high.

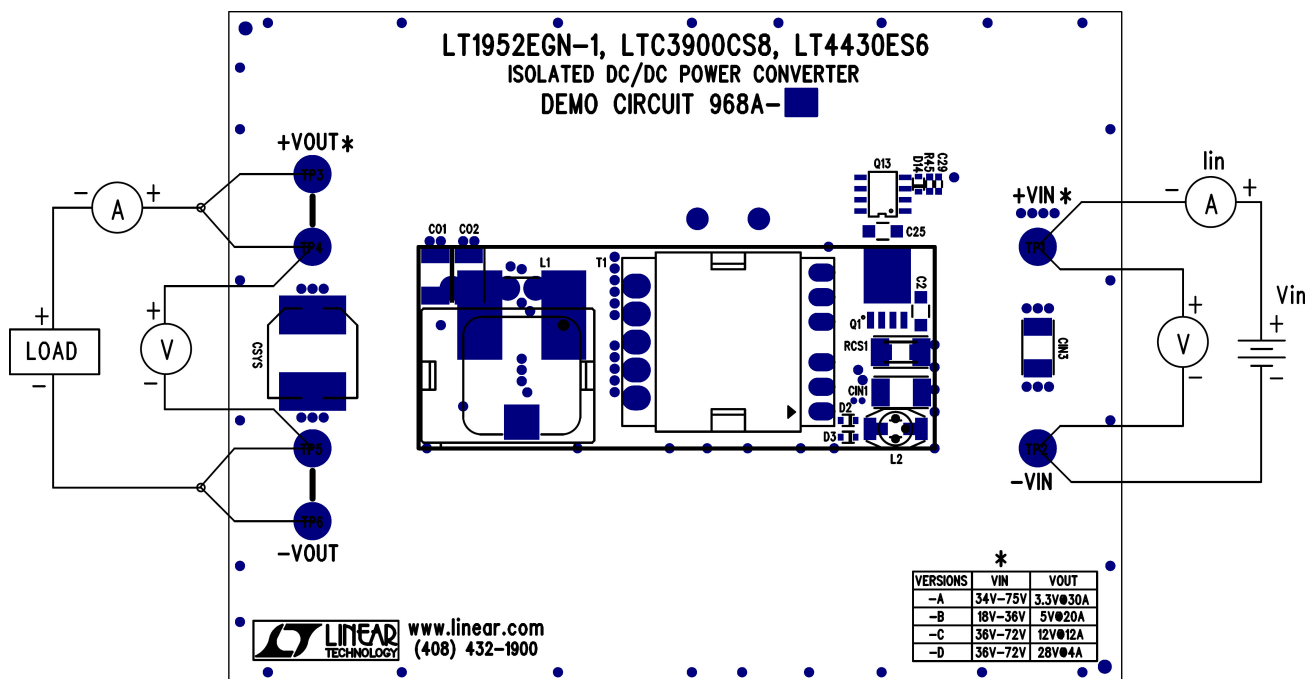

Figure 1. Proper Measurement Equipment Setup

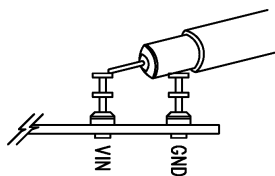

Figure 2. Scope Probe Placement for Measuring Input or Output Ripple

CHANGING THE OUTPUT VOLTAGE

To set the output voltage lower than 3.3V, change the bottom voltage divider resistor connected to LT4430 FB pin (see the schematic on page 5). For example, to get 2.5V output, change R38 resistor value to 26.1k.

To get higher than 3.3V output voltages transformer with higher turns ratio will be required. Also, output MOSFETs with higher voltage ratings may be required. Please contact LTC factory for details.

PRIMARY MOSFET DRIVER LTC4440

The DC968 has an LTC4440 MOSFET driver U2. The LTC4440 can be disabled if the efficiency is not important. If U2 is disabled, the DELAY pin of LT1952 should be readjusted to optimize the efficiency. Please contact LT factory for assistance.

OPTIONAL RESET CIRCUIT

The DC968 is equipped with an optional active reset circuit that is disabled on DC968A-A. In most applications the circuit is not required because there is no benefit from active reset. However, if the active reset is required, adding few resistors can enable the circuit. Please consult LT factory for assistance.

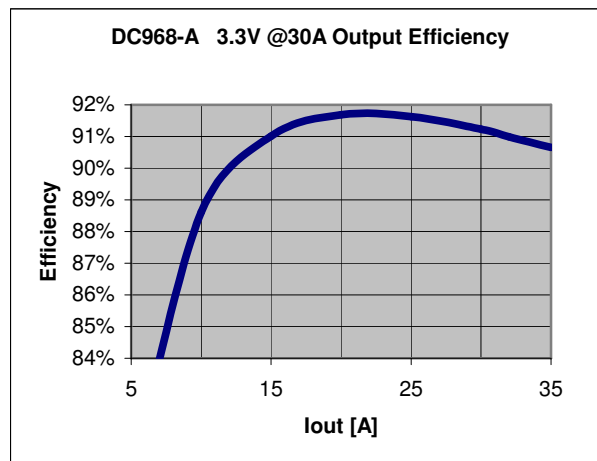

Figure 3. High efficiency of DC968A-A allows the board to be used in thermally critical applications

OUTPUT LOAD STEP RESPONSE

The load step response of DC968A-A is very fast even though relatively small amount of output capacitance is present (200uF ceramic and 470uF electrolytic). This is thanks to fast error amplifier of LT4430, optimal amount of current slope compensation of LT1952, fast opto coupler and fast error amplifier of LT1952. If higher load steps need to be handled more output capacitance can be added in order to keep the voltage transients at the desired level. The load step transients are shown in Figure 4.

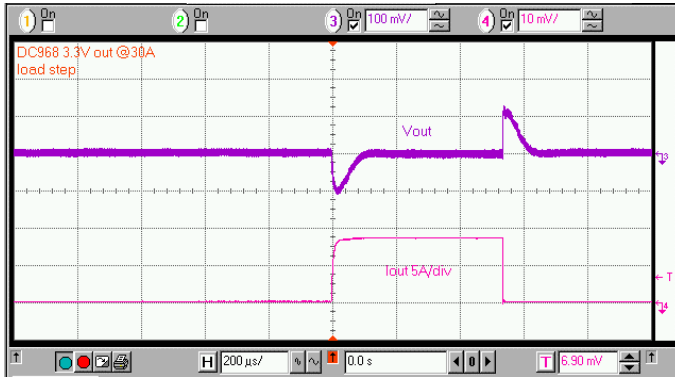

Figure 4. Fast transient response of DC968 is superior to many competing power modules without the additional output capacitors.

SOFT START FUNCTION

The DC968 features LT4430 opto coupler driver that has soft start function which produces monotonic startup ramp shown in Figure 5. The rise time of output voltage is controlled by capacitor C19 that is connected to OC (overshoot control) pin of LT4430.

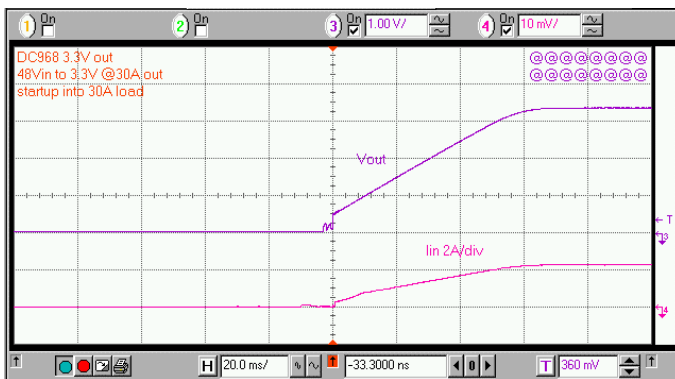

Figure 5. The LT4430 opto coupler driver produces monotonic output voltage rise at startup without output voltage overshoot.

DEBUGGING AND TESTING

The DC968 can easily be tested and debugged by powering the bias circuit separately from the main power circuit. To place DC968 into debug mode remove the resistor R1 and connect 48V, 100mA power source to +Vb node (right side of R1). By doing this, the primary PWM controller LT1952 can be activated without the main primary power being applied to +Vin.

To activate the secondary side MOSFET driver (LTC3900) diode OR a 10V, 100mA power source into collector of Q9.

Once the primary and secondary controllers are running the MOSFET gate timing can be checked.

If the MOSFET gate timing is correct the main power input can be applied to +Vin. The delay from turn on of FG and gate of Q1 should be in the range from -100ns to +100ns. By slowly increasing the +Vin from 0V to 48V output voltage and input current can be monitored. The input current should not exceeded 100mA without the output load. If one of the MOSFETs is damaged, the input current will exceed 100mA.

QUICK START GUIDE FOR DEMONSTRATION CIRCUIT 968A-A

ISOLATED DC/DC POWER CONVERTER

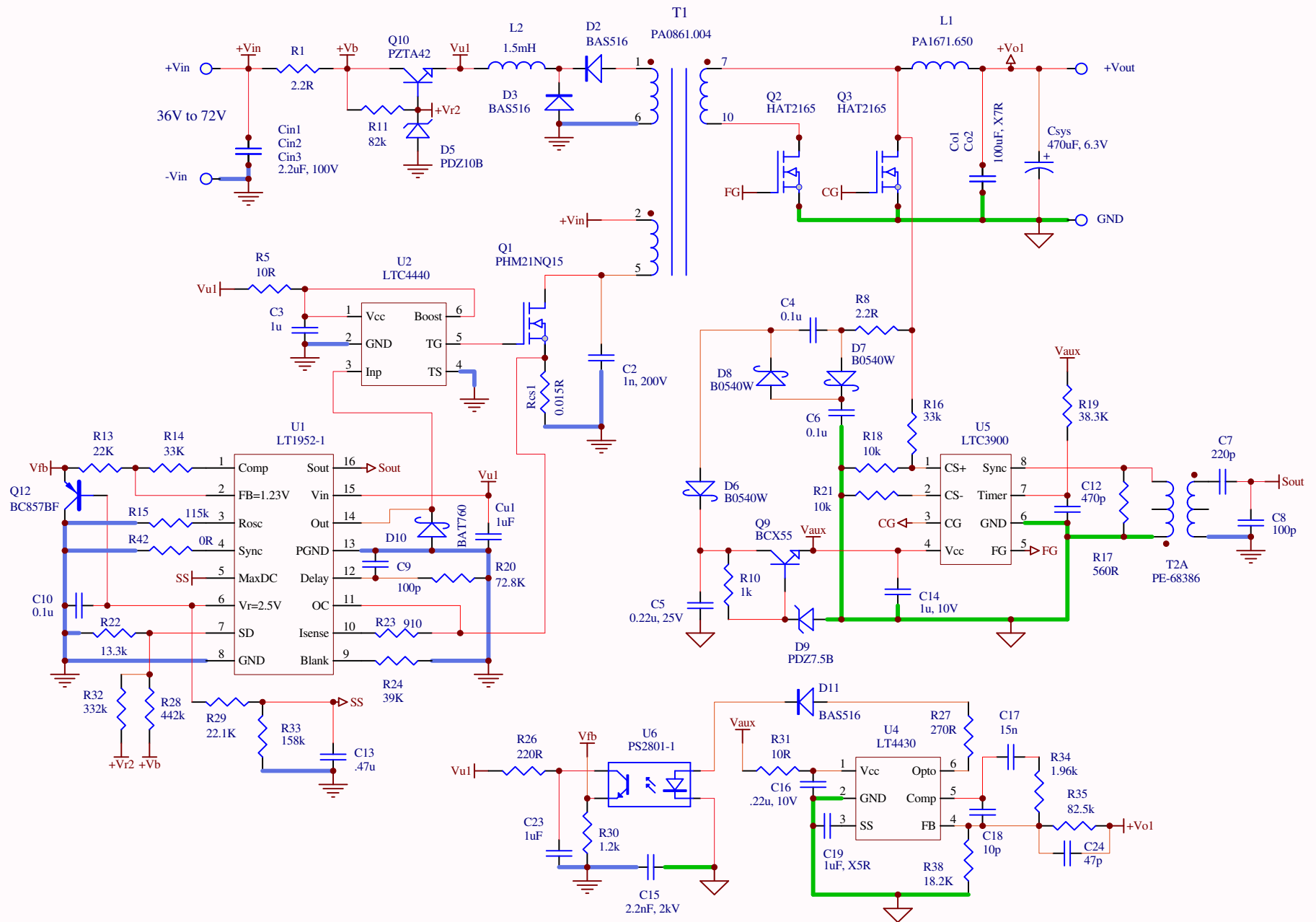

QUICK START GUIDE FOR DEMONSTRATION CIRCUIT 968A-A

ISOLATED DC/DC POWER CONVERTER

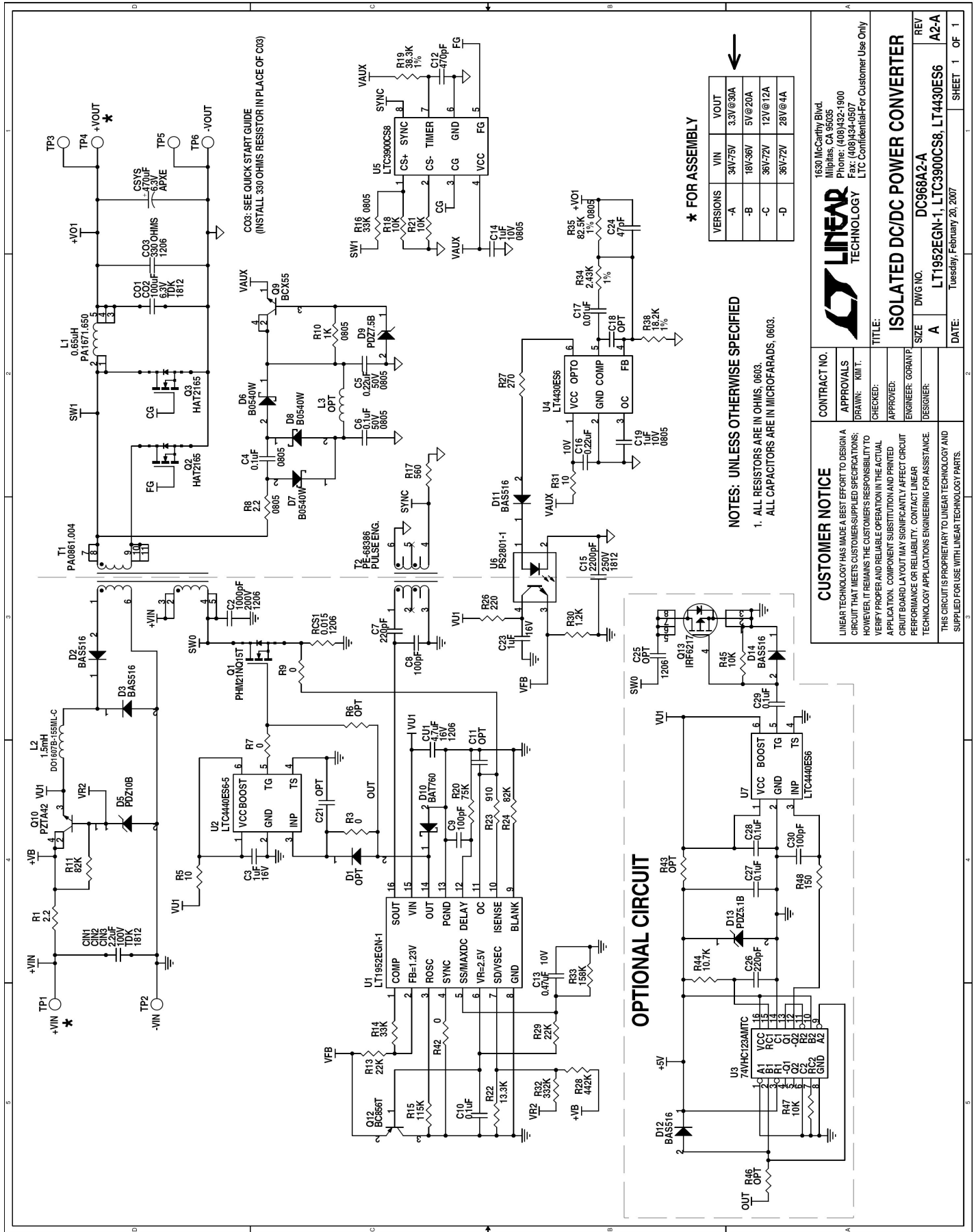

*** FOR ASSEMBLY**

VERSIONS	VIN	VOUIT
-A	34V/75V	3.3V@30A
-B	18V/36V	5V@20A
-C	36V/72V	12V@12A
-D	36V/72V	28V@4A

NOTES: UNLESS OTHERWISE SPECIFIED

- ALL RESISTORS ARE IN OHMS, 0603.
- ALL CAPACITORS ARE IN MICROFARADS, 0603.

LINEAR TECHNOLOGY

1630 McCarthy Blvd.
Milpitas, CA 95025
Phone: (408) 322-1900
Fax: (408) 343-9307
LTC Confidential For Customer Use Only

CUSTOMER NOTICE

LINEAR TECHNOLOGY HAS MADE A BEST EFFORT TO DESIGN A CIRCUIT THAT MEETS CUSTOMER-SUPPLIED SPECIFICATIONS; HOWEVER, IT REMAINS THE CUSTOMER'S RESPONSIBILITY TO VERIFY PROPER AND RELIABLE OPERATION IN THE ACTUAL APPLICATION. COMPONENT SUBSTITUTION AND PRINTED CIRCUIT BOARD LAYOUT MAY SIGNIFICANTLY AFFECT CIRCUIT PERFORMANCE OR RELIABILITY. CONTACT LINEAR TECHNOLOGY APPLICATIONS ENGINEERING FOR ASSISTANCE. THIS CIRCUIT IS PROPRIETARY TO LINEAR TECHNOLOGY AND SUPPLIED FOR USE WITH LINEAR TECHNOLOGY PARTS.

CUSTOMER NOTICE

CONTRACT NO. _____

APPROVALS _____

DRAWN: KIM T. _____

CHECKED: _____

ENGINEER: GORAN P. _____

DESIGNER: _____

TITLE: ISOLATED DC/DC POWER CONVERTER

REV: A2-A

SIZE: A

DWG NO.: DC968A2-A

DATE: Tuesday, February 20, 2007

SHEET 1 OF 1