

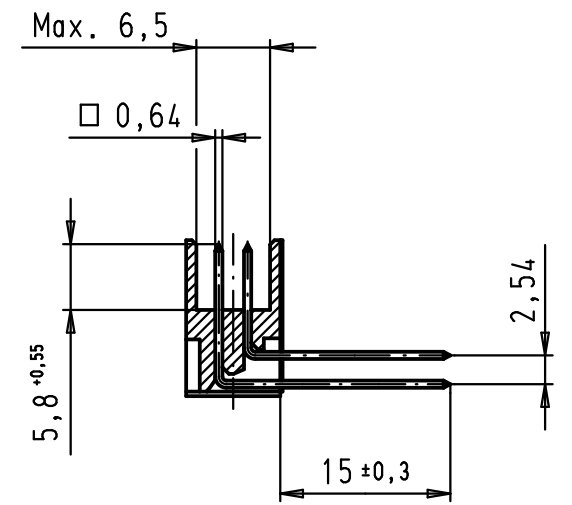

Alle Rechte vorbehalten/ All rights reserved

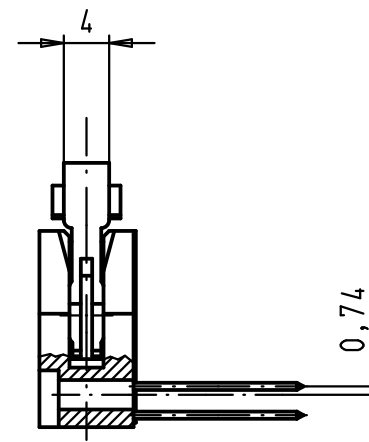
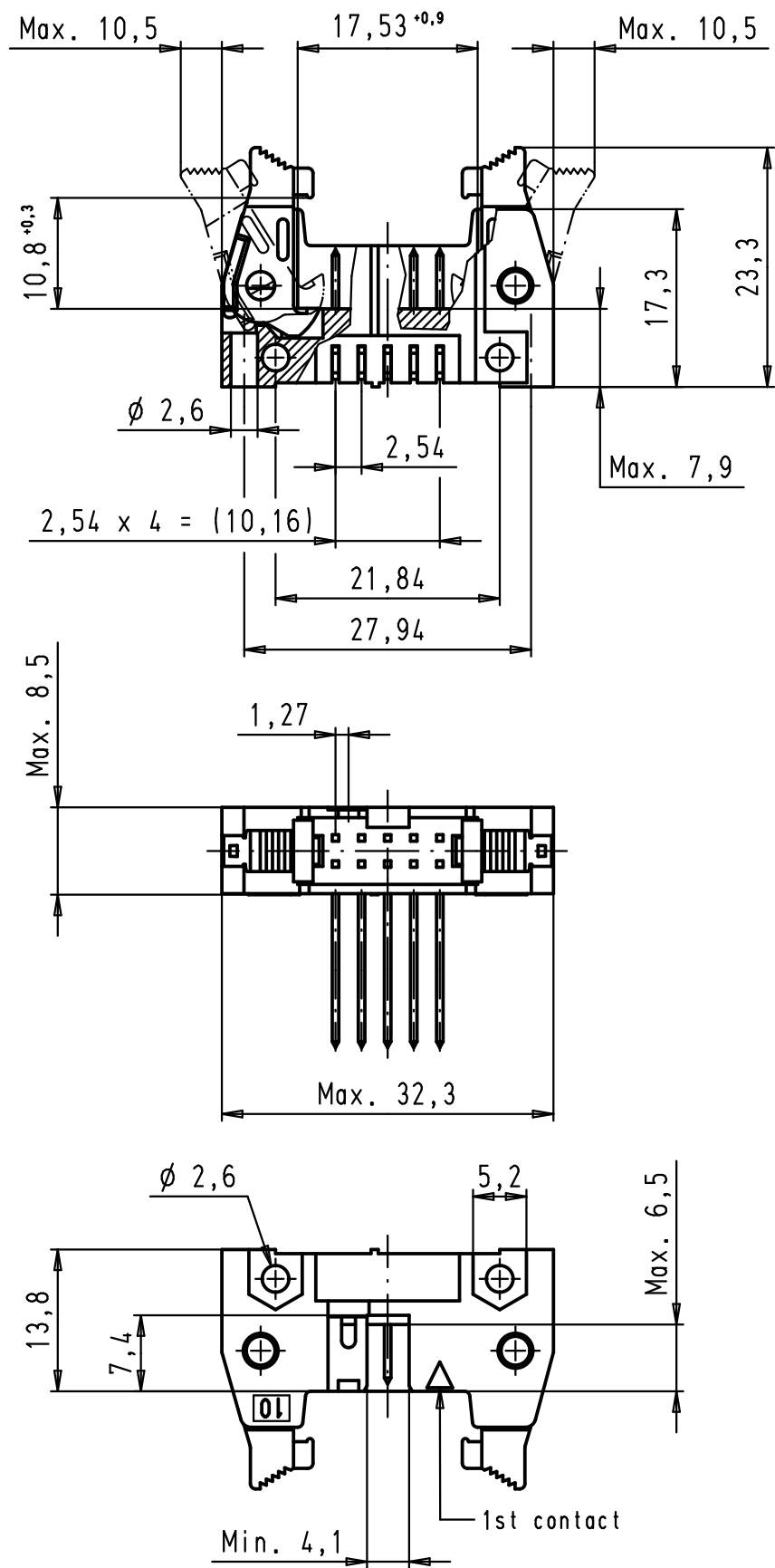
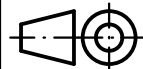

09 18 510 7916	3
09 18 510 6916	2
09 18 510 5916	0,76 μ m Au
Part number	Performance level

				Det.	Name	 All Dim. in mm Orig. Size DIN A 3	SEK 18 Male Connector Standard 10 poles Angled wrap posts Short locking levers	Maßstab/ Scale 1,5:1
			Detail.	19/09/02	CV			
			Insp.					
			Stand.					
34890	13/06/08	PK	HARTING EURL			TB 09 18 510 X916	Blatt/ Page 1 / 1	
31092	19/09/02	CV	F-95972 Paris					
Mod.	Det.	Name					Sub.	