

74LVC541A

Low-Voltage CMOS Octal Buffer Flow Through Pinout

With 5 V-Tolerant Inputs and Outputs (3-State, Non-Inverting)

The 74LVC541A is a high performance, non-inverting octal buffer operating from a 1.2 to 3.6 V supply. This device is similar in function to the MC74LCX244, while providing flow through architecture. High impedance TTL compatible inputs significantly reduce current loading to input drivers while TTL compatible outputs offer improved switching noise performance. A V_I specification of 5.5 V allows 74LVC541A inputs to be safely driven from 5 V devices. The 74LVC541A is suitable for memory address driving and all TTL level bus oriented transceiver applications.

Current drive capability is 24 mA at the outputs. The Output Enable ($\overline{OE1}$, $\overline{OE2}$) inputs, when HIGH, disables the output by placing them in a HIGH Z condition.

Features

- Designed for 1.2 to 3.6 V V_{CC} Operation
- 5 V Tolerant – Interface Capability With 5 V TTL Logic
- Supports Live Insertion and Withdrawal
- I_{OFF} Specification Guarantees High Impedance When $V_{CC} = 0$ V
- 24 mA Output Sink and Source Capability
- Near Zero Static Supply Current in All Three Logic States (10 μ A) Substantially Reduces System Power Requirements
- Latchup Performance Exceeds 250 mA
- ESD Performance:
 - ◆ Human Body Model > 2000 V
 - ◆ Machine Model > 200 V
- These Devices are Pb-Free, Halogen Free/BFR Free and are RoHS Compliant



ON Semiconductor®

www.onsemi.com

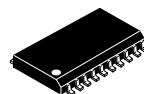

SOIC-20 WB
DW SUFFIX
CASE 751D

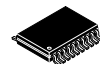

TSSOP-20
DT SUFFIX
CASE 948E

MARKING DIAGRAMS

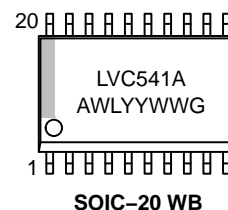

SOIC-20 WB

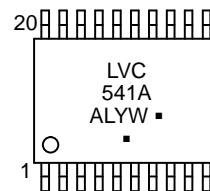

TSSOP-20

A = Assembly Location
L, WL = Wafer Lot
Y, YY = Year
W, WW = Work Week
G or ■ = Pb-Free Package

(Note: Microdot may be in either location)

ORDERING INFORMATION

See detailed ordering and shipping information in the package dimensions section on page 7 of this data sheet.

74LVC541A

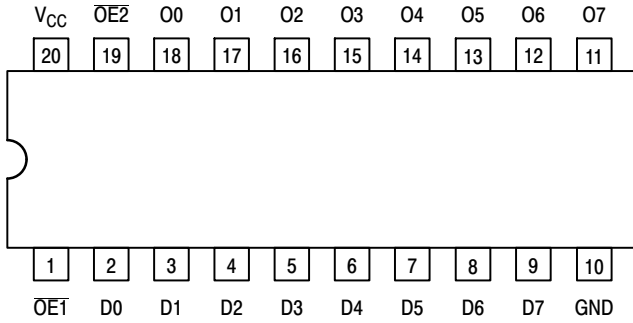

Figure 1. Pinout: 20-Lead (Top View)

PIN NAMES

Pins	Function
$\overline{OE}1$	Output Enable Inputs
Dn	Data Inputs
On	3-State Outputs

TRUTH TABLE

Inputs			Outputs
$\overline{OE}1$	$\overline{OE}2$	Dn	On
L	L	L	L
L	L	H	H
X	H	X	Z
H	X	X	Z

H = High Voltage Level; L = Low Voltage Level; Z = High Impedance State;
 X = High or Low Voltage Level and Transitions are Acceptable, for I_{CC} reasons,
 DO NOT FLOAT Inputs

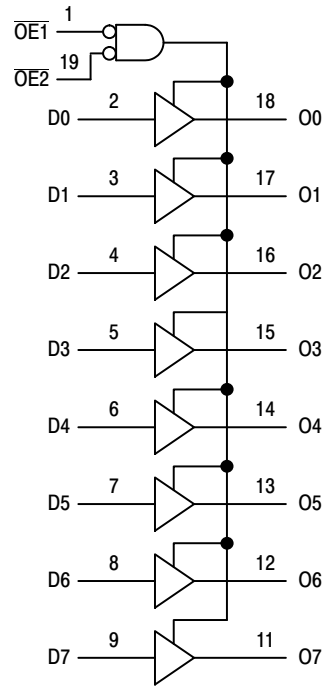

Figure 2. Logic Diagram

74LVC541A

MAXIMUM RATINGS

Symbol	Parameter	Value	Condition	Unit
V_{CC}	DC Supply Voltage	-0.5 to +6.5		V
V_I	DC Input Voltage	$-0.5 \leq V_I \leq +6.5$		V
V_O	DC Output Voltage	$-0.5 \leq V_O \leq +6.5$	Output in 3-State	V
		$-0.5 \leq V_O \leq V_{CC} + 0.5$	Output in HIGH or LOW State (Note 1)	V
I_{IK}	DC Input Diode Current	-50	$V_I < GND$	mA
I_{OK}	DC Output Diode Current	-50	$V_O < GND$	mA
		+50	$V_O > V_{CC}$	mA
I_O	DC Output Source/Sink Current	± 50		mA
I_{CC}	DC Supply Current Per Supply Pin	± 100		mA
I_{GND}	DC Ground Current Per Ground Pin	± 100		mA
T_{STG}	Storage Temperature Range	-65 to +150		°C
T_L	Lead Temperature, 1 mm from Case for 10 Seconds	$T_L = 260$		°C
T_J	Junction Temperature Under Bias	$T_J = 135$		°C
θ_{JA}	Thermal Resistance (Note 2)	SOIC = 65.8 TSSOP = 110.7		°C/W
MSL	Moisture Sensitivity		Level 1	
$I_{LATCHUP}$	Latch-up Performance at $V_{CC} = 3.6$ V and 125°C (Note 3)		± 250	mA

Stresses exceeding those listed in the Maximum Ratings table may damage the device. If any of these limits are exceeded, device functionality should not be assumed, damage may occur and reliability may be affected.

- I_O absolute maximum rating must be observed.
- Measured with minimum pad spacing on an FR4 board, using 10 mm-by-1 inch, 2 ounce copper trace no air flow.
- Tested to EIA/JES078.

RECOMMENDED OPERATING CONDITIONS

Symbol	Parameter	Min	Typ	Max	Units
V_{CC}	Supply Voltage Operating Functional	1.65 1.2		3.6 3.6	V
V_I	Input Voltage	0		5.5	V
V_O	Output Voltage HIGH or LOW State 3-State	0 0		V_{CC} 5.5	V
I_{OH}	HIGH Level Output Current $V_{CC} = 3.0$ V – 3.6 V $V_{CC} = 2.7$ V – 3.0 V			-24 -12	mA
I_{OL}	LOW Level Output Current $V_{CC} = 3.0$ V – 3.6 V $V_{CC} = 2.7$ V – 3.0 V			24 12	mA
T_A	Operating Free-Air Temperature	-40		+125	°C
$\Delta t/\Delta V$	Input Transition Rise or Fall Rate, V_{IN} from 0.8 V to 2.0 V, $V_{CC} = 3.0$ V	0		10	ns/V

Functional operation above the stresses listed in the Recommended Operating Ranges is not implied. Extended exposure to stresses beyond the Recommended Operating Ranges limits may affect device reliability.

74LVC541A

DC ELECTRICAL CHARACTERISTICS

Symbol	Parameter	Conditions	-40°C to +85°C			-40°C to +125°C			Unit
			Min	Typ (Note 4)	Max	Min	Typ (Note 4)	Max	
V _{IH}	HIGH-level input voltage	V _{CC} = 1.2 V	1.08	-	-	1.08	-	-	V
		V _{CC} = 1.65 V to 1.95 V	0.65 x V _{CC}	-	-	0.65 x V _{CC}	-	-	
		V _{CC} = 2.3 V to 2.7 V	1.7	-	-	1.7	-	-	
		V _{CC} = 2.7 V to 3.6 V	2.0	-	-	2.0	-	-	
V _{IL}	LOW-level input voltage	V _{CC} = 1.2 V	-	-	0.12	-	-	0.12	V
		V _{CC} = 1.65 V to 1.95 V	-	-	0.35 x V _{CC}	-	-	0.35 x V _{CC}	
		V _{CC} = 2.3 V to 2.7 V	-	-	0.7	-	-	0.7	
		V _{CC} = 2.7 V to 3.6 V	-	-	0.8	-	-	0.8	
V _{OH}	HIGH-level output voltage	V _I = V _{IH} or V _{IL}							V
		I _O = -100 μA; V _{CC} = 1.65 V to 3.6 V	V _{CC} - 0.2	-	-	V _{CC} - 0.3	-	-	
		I _O = -4 mA; V _{CC} = 1.65 V	1.2	-	-	1.05	-	-	
		I _O = -8 mA; V _{CC} = 2.3 V	1.8	-	-	1.65	-	-	
		I _O = -12 mA; V _{CC} = 2.7 V	2.2	-	-	2.05	-	-	
		I _O = -18 mA; V _{CC} = 3.0 V	2.4	-	-	2.25	-	-	
		I _O = -24 mA; V _{CC} = 3.0 V	2.2	-	-	2.0	-	-	
V _{OL}	LOW-level output voltage	V _I = V _{IH} or V _{IL}							V
		I _O = 100 μA; V _{CC} = 1.65 V to 3.6 V	-	-	0.2	-	-	0.3	
		I _O = 4 mA; V _{CC} = 1.65 V	-	-	0.45	-	-	0.65	
		I _O = 8 mA; V _{CC} = 2.3 V	-	-	0.6	-	-	0.8	
		I _O = 12 mA; V _{CC} = 2.7 V	-	-	0.4	-	-	0.6	
		I _O = -24 mA; V _{CC} = 3.0 V	-	-	0.55	-	-	0.8	
I _I	Input leakage current	V _I = 5.5V or GND; V _{CC} = 3.6 V	-	±0.1	±5	-	±0.1	±20	μA
I _{OZ}	OFF-state output current	V _I = V _{IH} or V _{IL} ; V _O = 5.5 V or GND; V _{CC} = 3.6 V	-	±0.1	±5	-	±0.1	±20	μA
I _{OFF}	Power-off leakage current	V _I or V _O = 5.5 V; V _{CC} = 0.0 V	-	±0.1	±10	-	±0.1	±20	μA
I _{CC}	Supply current	V _I = V _{CC} or GND; I _O = 0 A; V _{CC} = 3.6 V	-	0.1	10	-	0.1	40	μA
ΔI _{CC}	Additional supply current	per input pin; V _I = V _{CC} - 0.6 V; I _O = 0 A; V _{CC} = 2.7 V to 3.6 V	-	5	500	-	5	5000	μA

Product parametric performance is indicated in the Electrical Characteristics for the listed test conditions, unless otherwise noted. Product performance may not be indicated by the Electrical Characteristics if operated under different conditions.

4. All typical values are measured at T_A = 25°C and V_{CC} = 3.3 V, unless stated otherwise.

74LVC541A

AC ELECTRICAL CHARACTERISTICS ($t_R = t_F = 2.5$ ns)

Symbol	Parameter	Conditions	-40°C to +85°C			-40°C to +125°C			Unit
			Min	Typ ¹	Max	Min	Typ ¹	Max	
t_{pd}	Propagation Delay (Note 6) nAn to nYn	$V_{CC} = 1.2$ V	–	14.0	–	–	–	–	ns
		$V_{CC} = 1.65$ V to 1.95 V	1.5	6.5	13.8	1.5	–	16.0	
		$V_{CC} = 2.3$ V to 2.7 V	1.0	3.5	6.8	1.0	–	7.9	
		$V_{CC} = 2.7$ V	1.5	3.5	5.6	1.5	–	7.0	
		$V_{CC} = 3.0$ V to 3.6 V	1.0	2.9	5.1	1.0	–	6.5	
t_{en}	Enable Time (Note 7) nOE to nYn	$V_{CC} = 1.2$ V	–	20.0	–	–	–	–	ns
		$V_{CC} = 1.65$ V to 1.95 V	1.8	7.7	16.0	1.8	–	18.5	
		$V_{CC} = 2.3$ V to 2.7 V	1.5	4.3	8.8	1.5	–	10.2	
		$V_{CC} = 2.7$ V	1.5	4.4	7.5	1.5	–	9.5	
		$V_{CC} = 3.0$ V to 3.6 V	1.0	3.5	7.0	1.0	–	9.0	
t_{dis}	Disable Time (Note 8) nOE to nYn	$V_{CC} = 1.2$ V	–	11.0	–	–	–	–	ns
		$V_{CC} = 1.65$ V to 1.95 V	3.0	4.9	10.3	3.0	–	11.9	
		$V_{CC} = 2.3$ V to 2.7 V	1.0	2.7	5.9	1.0	–	6.8	
		$V_{CC} = 2.7$ V	1.5	3.7	7.0	1.5	–	9.0	
		$V_{CC} = 3.0$ V to 3.6 V	1.0	3.3	6.0	1.0	–	7.5	
$t_{sk(0)}$	Output Skew Time (Note 9)		–	–	1	–	–	1.5	ns

Product parametric performance is indicated in the Electrical Characteristics for the listed test conditions, unless otherwise noted. Product performance may not be indicated by the Electrical Characteristics if operated under different conditions.

5. Typical values are measured at $T_A = 25^\circ\text{C}$ and $V_{CC} = 3.3$ V, unless stated otherwise.

6. t_{pd} is the same as t_{PLH} and t_{PHL} .

7. t_{en} is the same as t_{PZL} and t_{PZH} .

8. t_{dis} is the same as t_{PLZ} and t_{PHZ} .

9. Skew between any two outputs of the same package switching in the same direction. This parameter is guaranteed by design.

DYNAMIC SWITCHING CHARACTERISTICS

Symbol	Characteristic	Condition	$T_A = +25^\circ\text{C}$			Unit
			Min	Typ	Max	
V_{OLP}	Dynamic LOW Peak Voltage (Note 10)	$V_{CC} = 3.3$ V, $C_L = 50$ pF, $V_{IH} = 3.3$ V, $V_{IL} = 0$ V $V_{CC} = 2.5$ V, $C_L = 30$ pF, $V_{IH} = 2.5$ V, $V_{IL} = 0$ V		0.8 0.6		V
V_{OLV}	Dynamic LOW Valley Voltage (Note 10)	$V_{CC} = 3.3$ V, $C_L = 50$ pF, $V_{IH} = 3.3$ V, $V_{IL} = 0$ V $V_{CC} = 2.5$ V, $C_L = 30$ pF, $V_{IH} = 2.5$ V, $V_{IL} = 0$ V		-0.8 -0.6		V

10. Number of outputs defined as “n”. Measured with “n–1” outputs switching from HIGH–to–LOW or LOW–to–HIGH. The remaining output is measured in the LOW state.

CAPACITIVE CHARACTERISTICS

Symbol	Parameter	Condition	Typical	Unit
C_{IN}	Input Capacitance	$V_{CC} = 3.3$ V, $V_I = 0$ V or V_{CC}	4.0	pF
C_{OUT}	Output Capacitance	$V_{CC} = 3.3$ V, $V_I = 0$ V or V_{CC}	5.0	pF
C_{PD}	Power Dissipation Capacitance (Note 11)	Per input; $V_I = \text{GND}$ or V_{CC}		pF
		$V_{CC} = 1.65$ V to 1.95 V	7.7	
		$V_{CC} = 2.3$ V to 2.7 V	11.3	
		$V_{CC} = 3.0$ V to 3.6 V	14.4	

11. C_{PD} is used to determine the dynamic power dissipation (P_D in μW).

$P_D = C_{PD} * V_{CC}^2 * f_i * N + \sum (C_L * V_{CC}^2 * f_o)$ where:

f_i = input frequency in MHz; f_o = output frequency in MHz

C_L = output load capacitance in pF V_{CC} = supply voltage in Volts

N = number of outputs switching

$\sum(C_L * V_{CC}^2 * f_o)$ = sum of the outputs.

74LVC541A

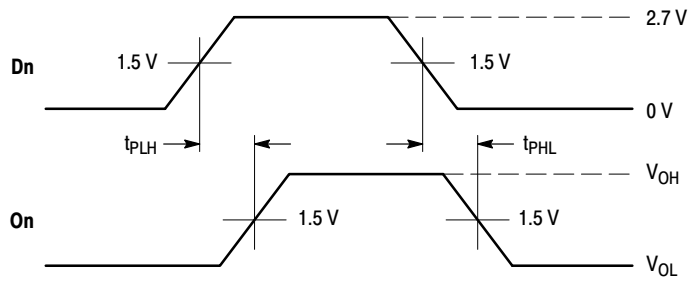

WAVEFORM 1 - PROPAGATION DELAYS

$t_R = t_F = 2.5 \text{ ns}$, 10% to 90%; $f = 1 \text{ MHz}$; $t_W = 500 \text{ ns}$

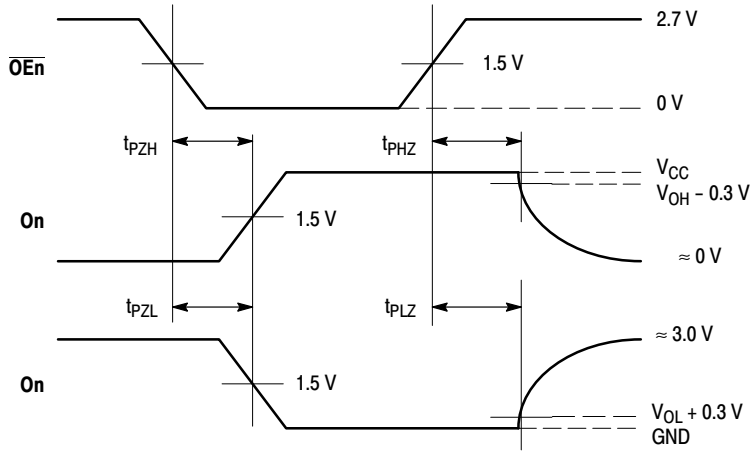

WAVEFORM 2 - OUTPUT ENABLE AND DISABLE TIMES

$t_R = t_F = 2.5 \text{ ns}$, 10% to 90%; $f = 1 \text{ MHz}$; $t_W = 500 \text{ ns}$

Figure 3. AC Waveforms

Symbol	V_{CC}		
	$3.3 \text{ V} \pm 0.3 \text{ V}$	2.7 V	$V_{CC} < 2.7 \text{ V}$
V_{mi}	1.5 V	1.5 V	$V_{CC}/2$
V_{mo}	1.5 V	1.5 V	$V_{CC}/2$
V_{HZ}	$V_{OL} + 0.3 \text{ V}$	$V_{OL} + 0.3 \text{ V}$	$V_{OL} + 0.15 \text{ V}$
V_{LZ}	$V_{OH} - 0.3 \text{ V}$	$V_{OH} - 0.3 \text{ V}$	$V_{OH} - 0.15 \text{ V}$

74LVC541A

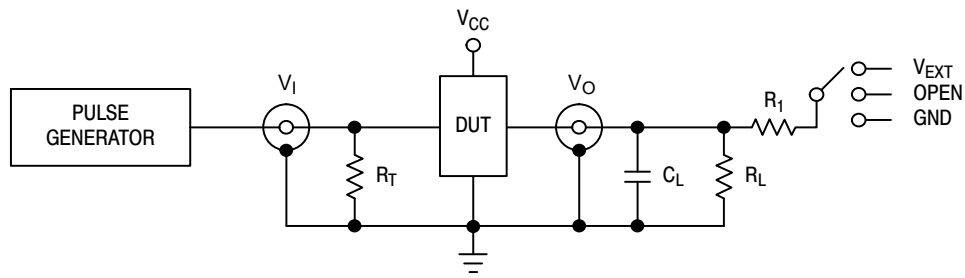

C_L includes jig and probe capacitance
 $R_T = Z_{OUT}$ of pulse generator (typically 50 Ω)
 $R_1 = R_L$

Supply Voltage	Input		Load		V_{EXT}		
V_{CC} (V)	V_I	t_r, t_f	C_L	R_L	t_{PLH}, t_{PHL}	t_{PLZ}, t_{PZL}	t_{PHZ}, t_{PZH}
1.2	V_{CC}	≤ 2 ns	30 pF	1 k Ω	Open	2 x V_{CC}	GND
1.65 – 1.95	V_{CC}	≤ 2 ns	30 pF	1 k Ω	Open	2 x V_{CC}	GND
2.3 – 2.7	V_{CC}	≤ 2 ns	30 pF	500 Ω	Open	2 x V_{CC}	GND
2.7	2.7 V	≤ 2.5 ns	50 pF	500 Ω	Open	2 x V_{CC}	GND
3 – 3.6	2.7 V	≤ 2.5 ns	50 pF	500 Ω	Open	2 x V_{CC}	GND

Figure 4. Test Circuit

ORDERING INFORMATION

Device	Package	Shipping [†]
74LVC541ADWR2G	SOIC-20 (Pb-Free)	1000 / Tape & Reel
74LVC541ADTR2G	TSSOP-20 (Pb-Free)	2500 / Tape & Reel

[†]For information on tape and reel specifications, including part orientation and tape sizes, please refer to our Tape and Reel Packaging Specifications Brochure, BRD8011/D.

74LVC541A

PACKAGE DIMENSIONS

TSSOP-20
CASE 948E-02
ISSUE C

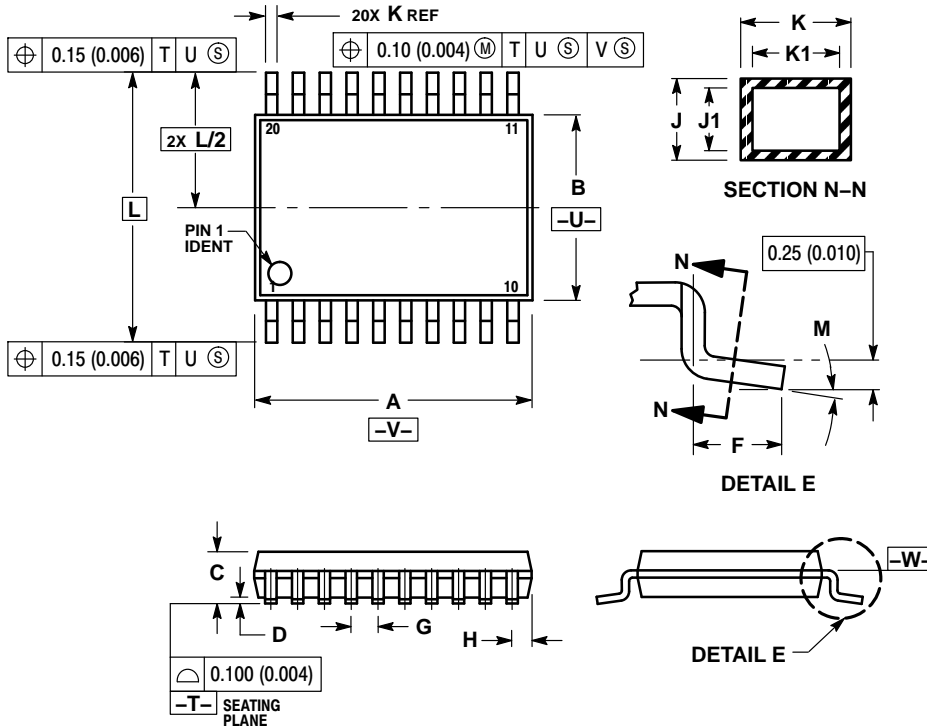

NOTES:

1. DIMENSIONING AND TOLERANCING PER ANSI Y14.5M, 1982.
2. CONTROLLING DIMENSION: MILLIMETER.
3. DIMENSION A DOES NOT INCLUDE MOLD FLASH, PROTRUSIONS OR GATE BURRS. MOLD FLASH OR GATE BURRS SHALL NOT EXCEED 0.15 (0.006) PER SIDE.
4. DIMENSION B DOES NOT INCLUDE INTERLEAD FLASH OR PROTRUSION. INTERLEAD FLASH OR PROTRUSION SHALL NOT EXCEED 0.25 (0.010) PER SIDE.
5. DIMENSION K DOES NOT INCLUDE DAMBAR PROTRUSION. ALLOWABLE DAMBAR PROTRUSION SHALL BE 0.08 (0.003) TOTAL IN EXCESS OF THE K DIMENSION AT MAXIMUM MATERIAL CONDITION.
6. TERMINAL NUMBERS ARE SHOWN FOR REFERENCE ONLY.
7. DIMENSION A AND B ARE TO BE DETERMINED AT DATUM PLANE -W-.

DIM	MILLIMETERS		INCHES	
	MIN	MAX	MIN	MAX
A	6.40	6.60	0.252	0.260
B	4.30	4.50	0.169	0.177
C	---	1.20	---	0.047
D	0.05	0.15	0.002	0.006
F	0.50	0.75	0.020	0.030
G	0.65 BSC		0.026 BSC	
H	0.27	0.37	0.011	0.015
J	0.09	0.20	0.004	0.008
J1	0.09	0.16	0.004	0.006
K	0.19	0.30	0.007	0.012
K1	0.19	0.25	0.007	0.010
L	6.40 BSC		0.252 BSC	
M	0°	8°	0°	8°

SOLDERING FOOTPRINT*

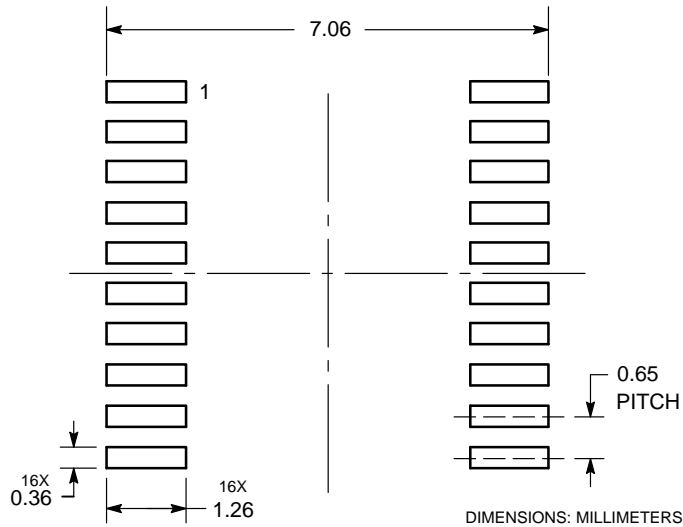

*For additional information on our Pb-Free strategy and soldering details, please download the ON Semiconductor Soldering and Mounting Techniques Reference Manual, SOLDERRM/D.

74LVC541A

PACKAGE DIMENSIONS

SOIC-20 WB
CASE 751D-05
ISSUE G

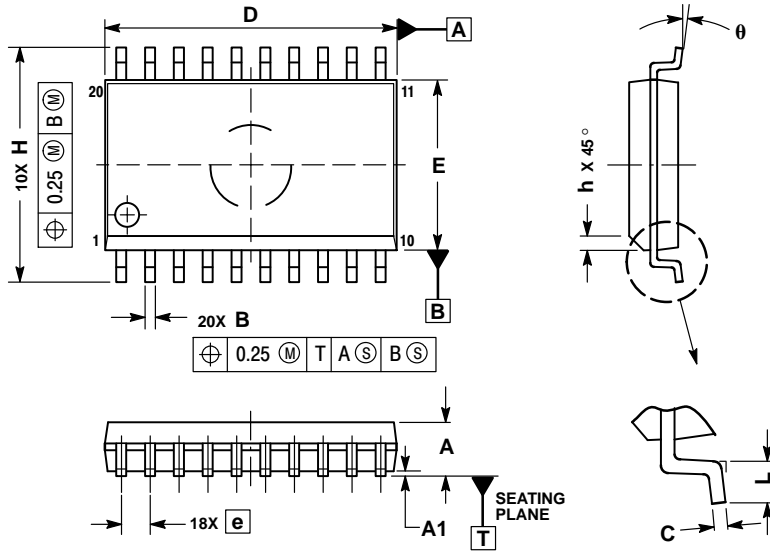

NOTES:

1. DIMENSIONS ARE IN MILLIMETERS.
2. INTERPRET DIMENSIONS AND TOLERANCES PER ASME Y14.5M, 1994.
3. DIMENSIONS D AND E DO NOT INCLUDE MOLD PROTRUSION.
4. MAXIMUM MOLD PROTRUSION 0.15 PER SIDE.
5. DIMENSION B DOES NOT INCLUDE DAMBAR PROTRUSION. ALLOWABLE PROTRUSION SHALL BE 0.13 TOTAL IN EXCESS OF B DIMENSION AT MAXIMUM MATERIAL CONDITION.

DIM	MILLIMETERS	
	MIN	MAX
A	2.35	2.65
A1	0.10	0.25
B	0.35	0.49
C	0.23	0.32
D	12.65	12.95
E	7.40	7.60
e	1.27 BSC	
H	10.05	10.55
h	0.25	0.75
L	0.50	0.90
θ	0°	7°

ON Semiconductor and the  are registered trademarks of Semiconductor Components Industries, LLC (SCILLC) or its subsidiaries in the United States and/or other countries. SCILLC owns the rights to a number of patents, trademarks, copyrights, trade secrets, and other intellectual property. A listing of SCILLC's product/patent coverage may be accessed at www.onsemi.com/site/pdf/Patent-Marking.pdf. SCILLC reserves the right to make changes without further notice to any products herein. SCILLC makes no warranty, representation or guarantee regarding the suitability of its products for any particular purpose, nor does SCILLC assume any liability arising out of the application or use of any product or circuit, and specifically disclaims any and all liability, including without limitation special, consequential or incidental damages. "Typical" parameters which may be provided in SCILLC data sheets and/or specifications can and do vary in different applications and actual performance may vary over time. All operating parameters, including "Typicals" must be validated for each customer application by customer's technical experts. SCILLC does not convey any license under its patent rights nor the rights of others. SCILLC products are not designed, intended, or authorized for use as components in systems intended for surgical implant into the body, or other applications intended to support or sustain life, or for any other application in which the failure of the SCILLC product could create a situation where personal injury or death may occur. Should Buyer purchase or use SCILLC products for any such unintended or unauthorized application, Buyer shall indemnify and hold SCILLC and its officers, employees, subsidiaries, affiliates, and distributors harmless against all claims, costs, damages, and expenses, and reasonable attorney fees arising out of, directly or indirectly, any claim of personal injury or death associated with such unintended or unauthorized use, even if such claim alleges that SCILLC was negligent regarding the design or manufacture of the part. SCILLC is an Equal Opportunity/Affirmative Action Employer. This literature is subject to all applicable copyright laws and is not for resale in any manner.

PUBLICATION ORDERING INFORMATION

LITERATURE FULFILLMENT:

Literature Distribution Center for ON Semiconductor
P.O. Box 5163, Denver, Colorado 80217 USA
Phone: 303-675-2175 or 800-344-3860 Toll Free USA/Canada
Fax: 303-675-2176 or 800-344-3867 Toll Free USA/Canada
Email: orderlit@onsemi.com

N. American Technical Support: 800-282-9855 Toll Free
USA/Canada
Europe, Middle East and Africa Technical Support:
Phone: 421 33 790 2910
Japan Customer Focus Center
Phone: 81-3-5817-1050

ON Semiconductor Website: www.onsemi.com
Order Literature: <http://www.onsemi.com/orderlit>

For additional information, please contact your local Sales Representative