



## Inductors CONTENTS

Classification	Product Item	Type · Series	Part Number	Page	
Power Inductors (SMD)	Power Choke Coils	PCC- M0530M/M0540M M0630M/M0645M M0754M/M0750M/M0854M M0850M/M1054M/M1050M M1050ML/M1060ML (MC) for automotive use	ETQ P3M□□□Y ETQ P4M□□□Y ETQ P5M□□□Y ETQ P6M□□□Y	2	
		PCC- M1280MF (MC) for automotive use	ETQ P8M□□□JFA	14	
		PCC- M0530M-LP/M0630M-LP M0840M-LP/M1040M-LP (MC) for automotive use	ETQ P3M□□□KV ETQ P4M□□□KV	19	
		PCC-D1413H (DUST) for automotive use	ETQ PDH240DTV	31	
		PCC-M0630L / M0630M (MC) for consumer use	ETQ P3L/3M	34	
		PCC-M0512W (MC) for consumer use	ETQ P1W	36	
		PCC-M0630W (MC) for consumer use	ETQ P3W	38	
		PCC-M0730L (MC) for consumer use	ETQ P3L	40	
		PCC-M0740L (MC) Low DCR Type for consumer use	ETQ P4L	42	
		PCC-M1040L (MC) for consumer use	ETQ P4L	44	
		PCC-M1040L (MC) Low DCR Type for consumer use	ETQ P4L	46	
		PCC-M1040W (MC) for consumer use	ETQ P4W	48	
		PCC-M1250L (MC) for consumer use	ETQ P5L	50	
		Packaging Methods · Soldering Conditions			52
		Safety Precautions (PCC for automotive use)			55
	Safety Precautions (PCC for consumer use)			57	
	Power Inductors	Selection Guide		58	
	Multilayer Power Inductors	Magnetic Shielded Type	ELG UEB	59	
			ELG TEA	61	
		Safety Precautions		63	
Power Inductors / Wire Wound type	Magnetic Shielded Type (Magnetic Adhesive Type)	ELL VEG, VFG-C, VGG, VGG-C	69		
		ELL 4FG-A, 4GG, 4LG-A	72		
		ELL 6GG, 6PG	75		
	Magnetic Shielded Type (Ring Core Type)	ELL 6RH, 6SH, 6UH	77		
		ELL 8TP	80		
		ELL ATP	82		
		ELL CTP	84		
Soldering Conditions · Safety Precautions			86		
Voltage Step-up Coils	Chip	ELT 3KN	88		
Power Inductors (THD)	Choke Coils Pin terminal	Common page		93	
		Regular Type	ELC 09D, 11D, 12D, 16B, 18B	95	
		Magnetic Shield Type	ELC 10E-L, 12E-L, 15E-L, 18E-L	100	
		Taping/Safety Precautions		104	

**All products in this catalog comply with the RoHS Directive.**

The RoHS Directive is “the Directive (2011/65/EU) on the Restriction of the Use of Certain Hazardous Substances in Electrical and Electronic Equipment “ and its revisions.

## Power Choke Coil for Automotive application

Series: **PCC-M0530M (MC) PCC-M0540M (MC)**  
**PCC-M0630M (MC) PCC-M0645M (MC)**  
**PCC-M0754M (MC) PCC-M0750M (MC)**  
**PCC-M0854M (MC) PCC-M0850M (MC)**  
**PCC-M1054M (MC) PCC-M1050M (MC)**  
**PCC-M1050ML (MC) PCC-M1060ML (MC)**

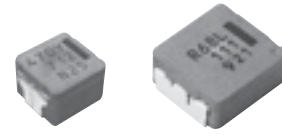

High heat resistance and high reliability  
 Using metal composite core (MC)

Industrial Property : patents 21 (Registered 2/Pending 19)

### Features

- High heat resistance : Operation up to 150 °C including self-heating
- High-reliability : High vibration resistance as result of newly developed integral construction; under severe reliability conditions of automotive and other strenuous applications
- High bias current : Excellent inductance stability using ferrous alloy magnetic material (Fig.1)
- Temp. stability : Excellent inductance stability over broad temp. range (Fig.1)
- Low audible (buzz) noise : New metal composite core technology
- High efficiency : Low  $R_{DC}$  of winding and low eddy-current loss of the core
- AEC-Q200 Automotive qualified
- RoHS compliant

● Fig.1 Inductance v.s. DC current, Temp.

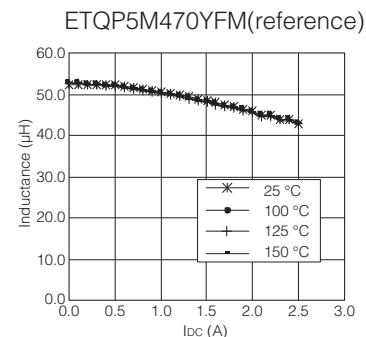

### Recommended Applications

- Noise filter for various drive circuitry requiring high temp. operation and peak current handling capability
- Boost-Converter, Buck-Converter DC/DC

### Standard Packing Quantity (Minimum Quantity/Packing Unit)

- 1,000 pcs./box (2 reel) : PCC-M0645M, M0754M, M0750M, M0854M, M0850M, M1054M, M1050M, M1050ML, M1060ML
- 2,000 pcs./box (2 reel) : PCC-M0530M, M0540M, M0630M

### Explanation of Part Numbers

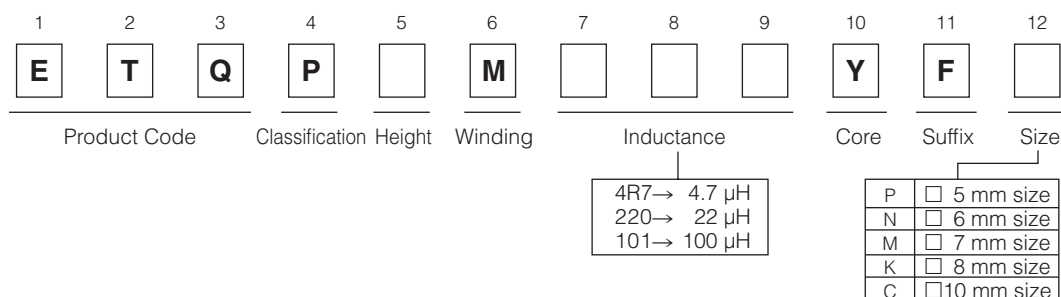

### Temperature rating

Operating temperature range		Tc : -40 °C to +150 °C (Including self-temperature rise)
Storage condition	After PWB mounting	
	Before PWB mounting	Ta : -5 °C to +35 °C 85%RH max.

## 1. Series PCC-M0530M/PCC-M0540M (ETQP3M□□□YFP/ETQP4M□□□YFP)

### Standard Parts

Series	Part No.	Inductance *1		DCR (at 20 °C) (mΩ)		Rated Current (Typ. : A)		
		L0 (μH)	Tolerance (%)	Typ. (max.)	Tolerance (%)	ΔT=40K		ΔL=-30%
						(*2)	(*3)	(*4)
PCC-M0530M [5.5×5.0×3.0(mm)]	ETQP3M2R2YFP	2.2	±20	22.6 (24.8)	±10	4.8	5.8	10.9
	ETQP3M3R3YFP	3.3		31.3 (34.4)		4.1	5.0	8.6
PCC-M0540M [5.5×5.0×4.0(mm)]	ETQP4M4R7YFP	4.7		36.0 (39.6)		4.0	4.8	7.7
	ETQP4M220YFP	22	163 (179)	1.9	2.3	3.1		

(\*1) Measured at 100 kHz.

(\*2) DC current which causes temperature rise of 40 K. Parts are soldered by reflow on four-layer PWB (1.6 mm FR4) and measured at room temperature. See also (\*5)

(\*3) DC current which causes temperature rise of 40 K. Parts are soldered by reflow on multilayer PWB with high heat dissipation performance. Note: Heat radiation constant are approx. 52 K/W measured on 5.5×5.0×3.0 mm case size and approx. 48 K/W measured on 5.5×5.0×4.0 mm case size. See also (\*5)

(\*4) Saturation rated current : DC current which causes L(0) drop -30 %.

(\*5) Within a suitable application, the part's temperature depends on circuit design and certain heat dissipation conditions. This should be double checked in a worst case operation mode.

In normal case, the max.standard operating temperature of +150 °C should not be exceeded.

For higher operating temperature conditions, please contact Panasonic representative in your area.

### Performance Characteristics (Reference)

#### ● Inductance vs DC Current

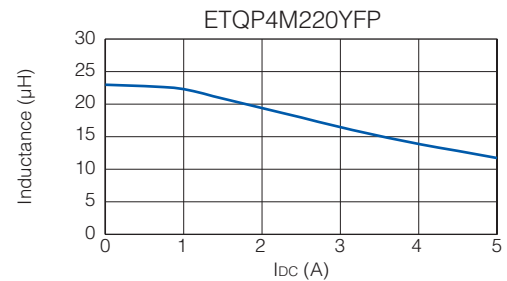
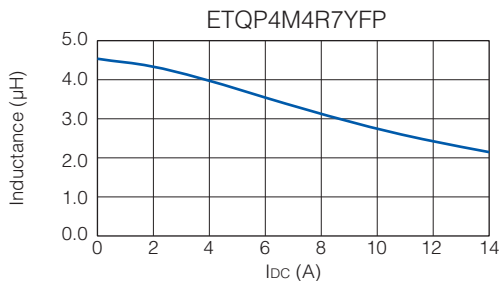
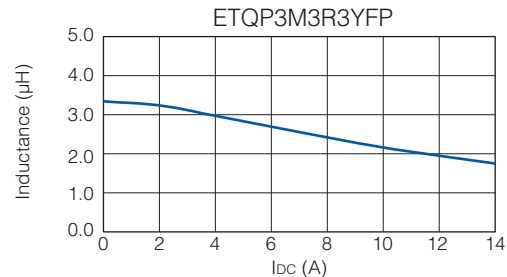
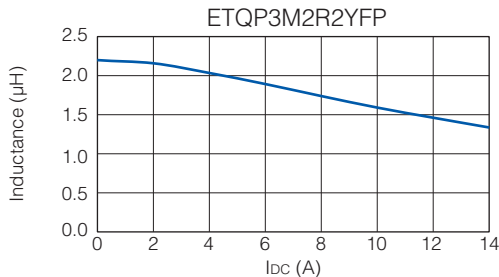

#### ● Case Temperature vs DC Current

PWB condition A : Four-layer PWB (1.6 mm FR4), See also (\*2)

PWB condition B : Multilayer PWB with high heat dissipation performance. See also (\*3)

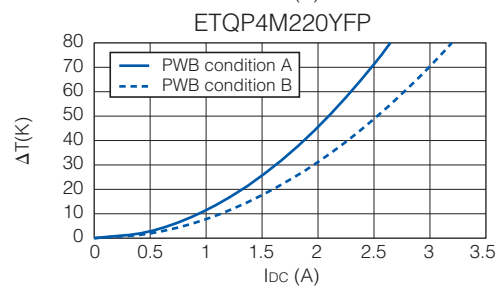
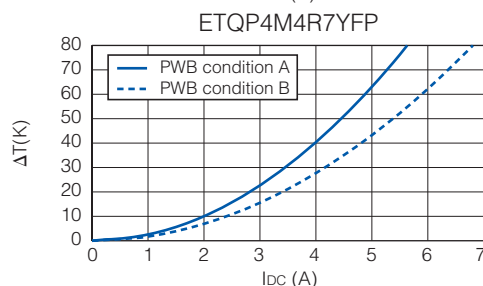
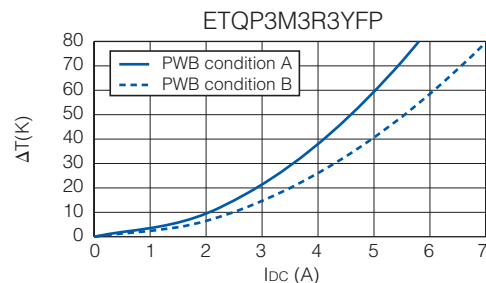
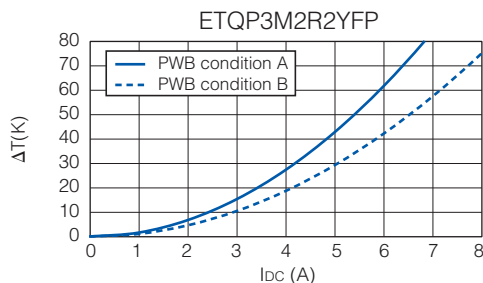

Design and specifications are each subject to change without notice. Ask factory for the current technical specifications before purchase and/or use.

Should a safety concern arise regarding this product, please be sure to contact us immediately.

## 2. Series PCC-M0630M/PCC-M0645M (ETQP3M□□□YFN/ETQP4M□□□YFN)

### Standard Parts

Series	Part No.	Inductance *1		DCR (at 20 °C) (mΩ)		Rated Current (Typ. : A)		
		L0 (μH)	Tolerance (%)	Typ. (max.)	Tolerance (%)	ΔT=40K		ΔL=-30%
						(*2)	(*3)	(*4)
PCC-M0630M [6.5×6.0×3.0(mm)]	ETQP3MR68YFN	0.68	±20	6.3 (6.9)	±10	9.8	12.0	24.0
	ETQP3M1R0YFN	1.0		7.9 (8.7)		8.8	10.7	20.0
PCC-M0645M [6.5×6.0×4.5(mm)]	ETQP4M6R8YFN	6.8	±20	39.3 (43.2)	±10	4.1	5.2	10.0
	ETQP4M100YFN	10		54.2 (59.6)		3.3	4.5	8.3
	ETQP4M470YFN	47		210 (231)		1.8	2.2	3.8

(\*1) Measured at 100 kHz.

(\*2) DC current which causes temperature rise of 40 K. Parts are soldered by reflow on four-layer PWB (1.6 mm FR4) and measured at room temperature. See also (\*5)

(\*3) DC current which causes temperature rise of 40 K. Parts are soldered by reflow on multilayer PWB with high heat dissipation performance. Note: Heat radiation constant are approx. 44 K/W measured on 6.5×6.0×3.0 mm case size and approx. 37 K/W measured on 6.5×6.0×4.5 mm case size. See also (\*5)

(\*4) Saturation rated current : DC current which causes L(0) drop -30 %.

(\*5) Within a suitable application, the part's temperature depends on circuit design and certain heat dissipation conditions. This should be double checked in a worst case operation mode.

In normal case, the max. standard operating temperature of +150 °C should not be exceeded.

For higher operating temperature conditions, please contact Panasonic representative in your area.

### Performance Characteristics (Reference)

#### ● Inductance vs DC Current

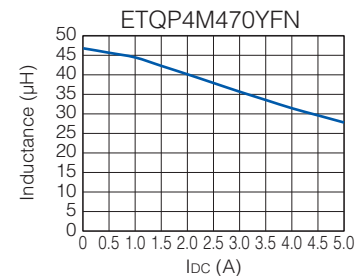
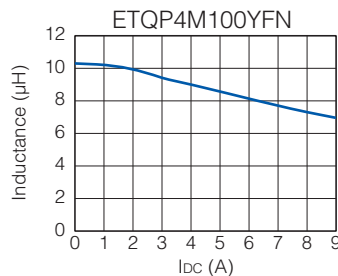
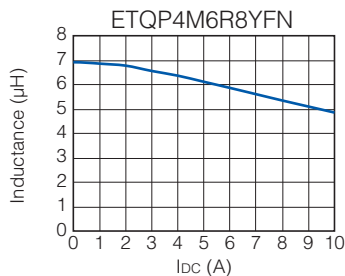
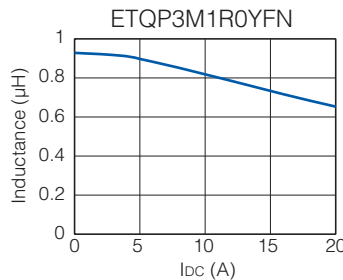
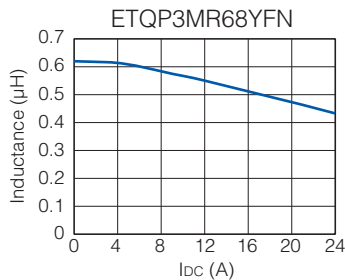

#### ● Case Temperature vs DC Current

PWB condition A : Four-layer PWB (1.6 mm FR4), See also (\*2)

PWB condition B : Multilayer PWB with high heat dissipation performance. See also (\*3)

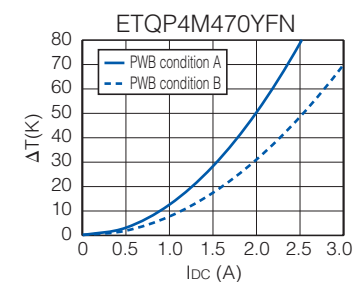
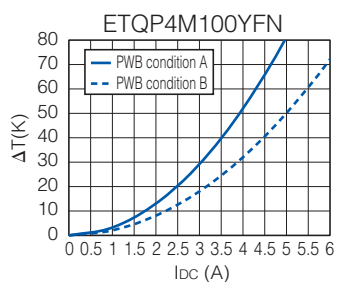
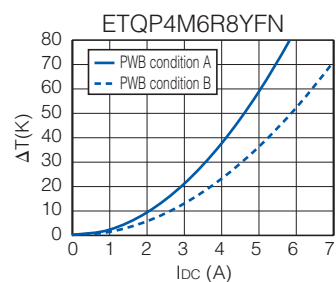
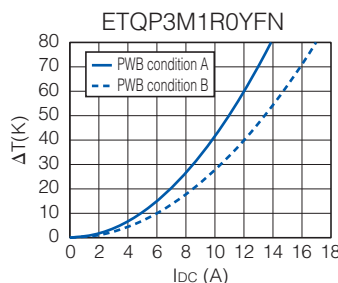
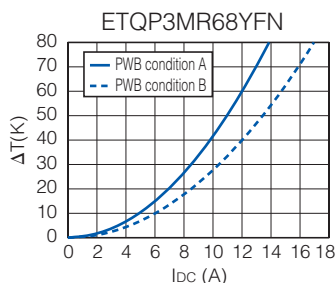

### 3. Series PCC-M0754M/PCC-M0750M (ETQP5M□□□YFM/ETQP5M□□□YGM)

#### Standard Parts

Series	Part No.	Inductance *1		DCR (at 20 °C) (mΩ)		Rated Current (Typ. : A)		
		L0 (μH)	Tolerance (%)	Typ. (max.)	Tolerance (%)	ΔT=40K		ΔL=-30%
						(*2)	(*3)	(*4)
PCC-M0754M [7.5×7.0×5.4(mm)]	ETQP5M4R7YFM	4.7	±20	20(23)	±10	6.3	8.0	13.1
	ETQP5M6R8YFM	6.8		26.7(29.4)		5.5	6.9	12.1
	ETQP5M100YFM	10		37.6(41.3)		4.7	5.7	10.6
	ETQP5M220YFM	22		92(102)		3.0	3.7	5.8
	ETQP5M330YFM	33		120(132)		2.6	3.3	4.8
	ETQP5M470YFM	48		156(172)		2.3	2.9	4.1
PCC-M0750M [7.5×7.0×5.0(mm)]	ETQP5M101YGM	95		348(382.8)		1.4	1.9	3.1

(\*1) Measured at 100 kHz.

(\*2) DC current which causes temperature rise of 40 K. Parts are soldered by reflow on four-layer PWB (1.6 mm FR4) and measured at room temperature. See also (\*5)

(\*3) DC current which causes temperature rise of 40 K. Parts are soldered by reflow on multilayer PWB with high heat dissipation performance. Note: Heat radiation constant is approx. 31 K/W measured on 7.5×7.0×5.4 mm case size and approx. 29 K/W measured on 7.5×7.0×5.0 mm case size. See also (\*5)

(\*4) Saturation rated current : DC current which causes L(0) drop -30 %.

(\*5) Within a suitable application, the part's temperature depends on circuit design and certain heat dissipation conditions. This should be double checked in a worst case operation mode.

In normal case, the max.standard operating temperature of +150 °C should not be exceeded.

For higher operating temperature conditions, please contact Panasonic representative in your area.

#### Performance Characteristics (Reference)

##### ● Inductance vs DC Current

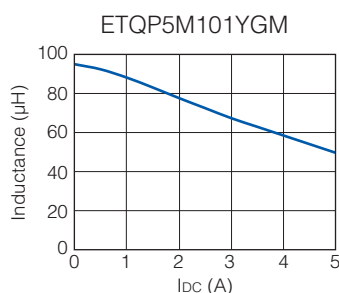
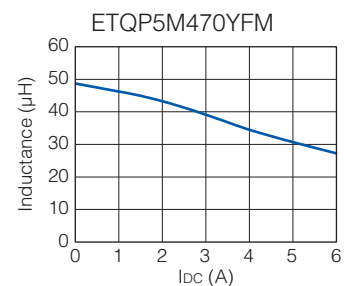
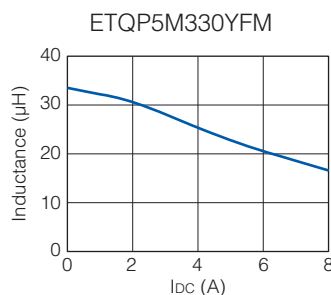
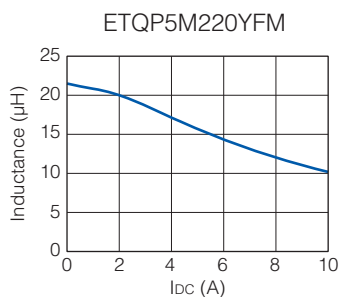
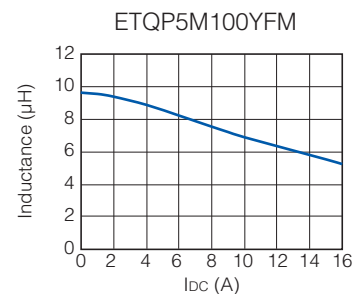
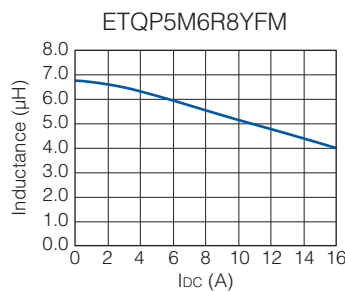
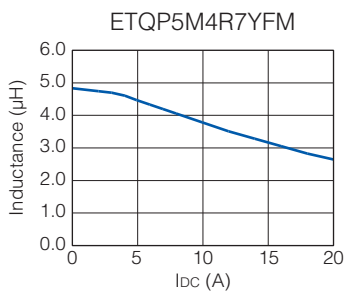

● Case Temperature vs DC Current

PWB condition A : Four-layer PWB (1.6 mm FR4), See also (\*2)

PWB condition B : Multilayer PWB with high heat dissipation performance. See also (\*3)

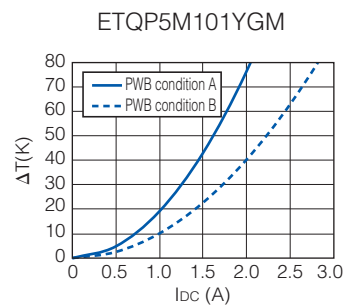
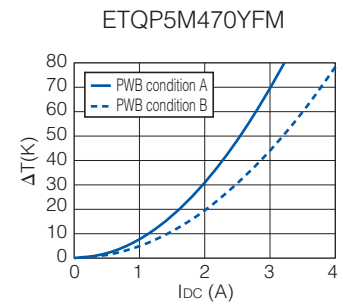
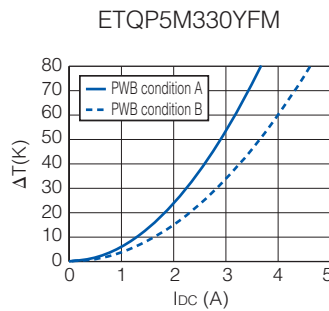
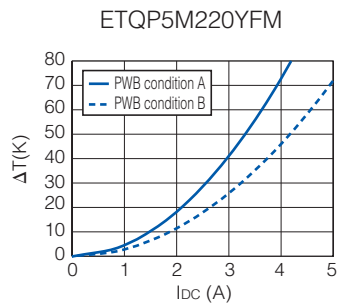
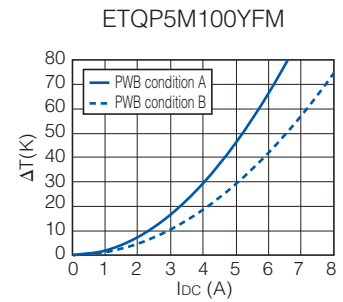
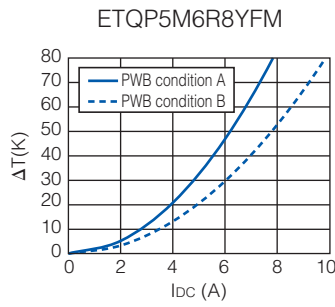
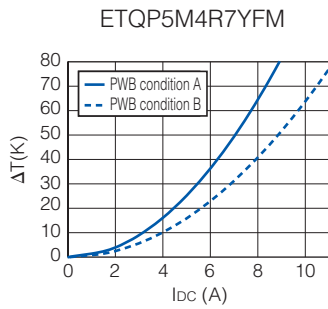

## 4. Series PCC-M0854M/PCC-M0850M (ETQP5M□□□YFK/ETQP5M□□□YGK)

Standard Parts		Inductance *1			DCR (at 20 °C) (mΩ)		Rated Current (Typ. : A)		
Series	Part No.	L0 (μH)	Tolerance (%)	Typ. (max.)	Tolerance (%)	ΔT=40K			
		ΔL=-30%							
		(*2)	(*3)	(*4)					
PCC-M0854M [8.5×8.0×5.4(mm)]	ETQP5M2R5YFK	2.5	±20	7.6(8.4)	±10	11.9	14.0	20.1	
	ETQP5M100YFK	10		33(37)		5.7	6.7	13.0	
	ETQP5M150YFK	15		48.2(53.1)		4.7	5.5	7.2	
	ETQP5M220YFK	22		63(70)		4.1	4.8	6.9	
	ETQP5M470YFK	48		125(138)		2.9	3.4	5.4	
PCC-M0850M [8.5×8.0×5.0(mm)]	ETQP5M101YGK	100		302(333)		1.7	2.1	3.0	

(\*1) Measured at 100 kHz.

(\*2) DC current which causes temperature rise of 40 K. Parts are soldered by reflow on four-layer PWB (1.6 mm FR4) and measured at room temperature. See also (\*5)

(\*3) DC current which causes temperature rise of 40 K. Parts are soldered by reflow on multilayer PWB with high heat dissipation performance. Note: Heat radiation constant are approx. 27 K/W measured on 8.5×8.0×5.4 mm case size and approx. 29 K/W measured on 8.5×8.0×5.0 mm case size. See also (\*5)

(\*4) Saturation rated current : DC current which causes L(0) drop -30 %.

(\*5) Within a suitable application, the part's temperature depends on circuit design and certain heat dissipation conditions. This should be double checked in a worst case operation mode.

In normal case, the max.standard operating temperature of + 150 °C should not be exceeded.

For higher operating temperature conditions, please contact Panasonic representative in your area.

## Performance Characteristics (Reference)

### ● Inductance vs DC Current

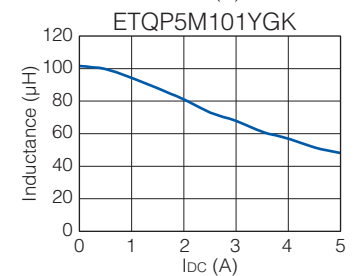
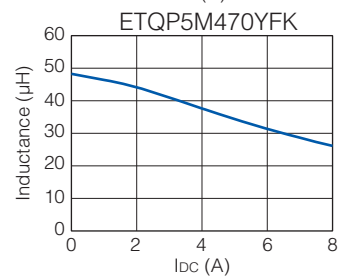
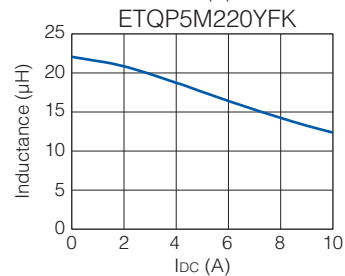
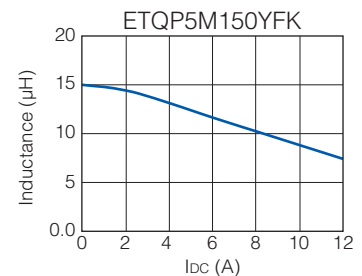
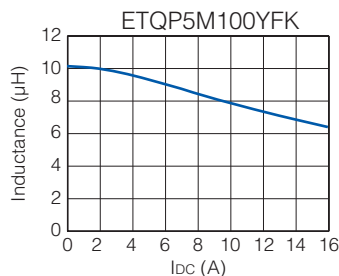
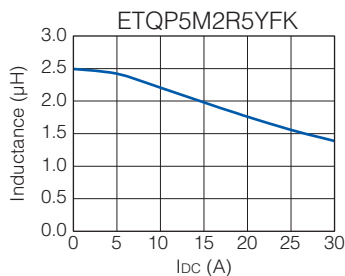

### ● Case Temperature vs DC Current

PWB condition A : Four-layer PWB (1.6 mm FR4), See also (\*2)

PWB condition B : Multilayer PWB with high heat dissipation performance. See also (\*3)

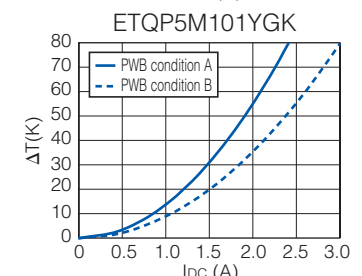
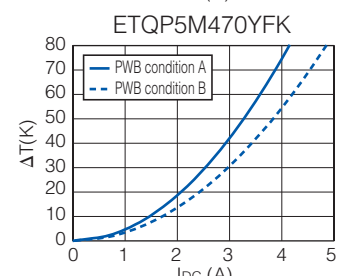
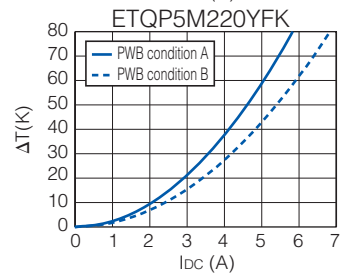
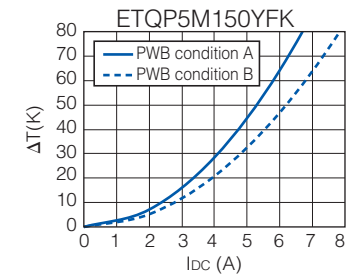
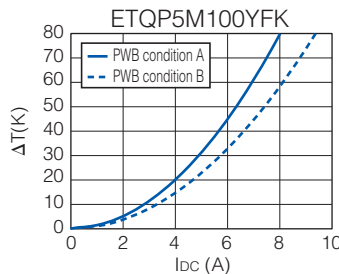
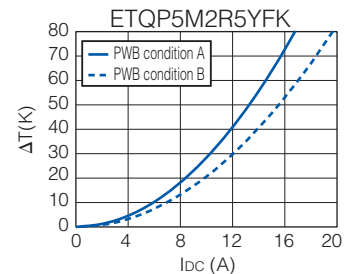

Design and specifications are each subject to change without notice. Ask factory for the current technical specifications before purchase and/or use.

Should a safety concern arise regarding this product, please be sure to contact us immediately.



## 5. Series PCC-M1054M/PCC-M1050M (ETQP5M□□□YFC/ETQP5M□□□YGC)

### Standard Parts

Series	Part No.	Inductance *1		DCR (at 20 °C) (mΩ)		Rated Current (Typ. : A)		
		L0 (μH)	Tolerance (%)	Typ. (max.)	Tolerance (%)	ΔT=40K (*2)	ΔT=40K (*3)	ΔL=-30% (*4)
PCC-M1054M [10.7×10.0×5.4(mm)]	ETQP5M1R5YFC	1.45	±20	3.8(4.2)	±10	17.9	21.4	35.1
	ETQP5M2R5YFC	2.5		5.3(5.9)		15.1	18.1	27.2
	ETQP5M3R3YFC	3.3		7.1(7.9)		13.1	15.7	22.7
	ETQP5M4R7YFC	4.7		10.2(11.3)		10.9	13.1	20.0
	ETQP5M100YFC	10		23.8(26.2)		7.1	8.5	10.7
	ETQP5M220YFC	22		45(50)		5.2	6.2	8.8
	ETQP5M330YFC	32.5		68.5(75.4)		4.2	5.0	7.6
	ETQP5M470YFC	47		99(108.9)		3.5	4.2	6.8
PCC-M1050M [10.7×10.0×5.0(mm)]	ETQP5M680YFC	66	136(149.6)	3.0	3.6	4.9		
	ETQP5M101YGC	97	208(229)	2.2	2.7	3.0		

(\*1) Measured at 100 kHz.

(\*2) DC current which causes temperature rise of 40 K. Parts are soldered by reflow on four-layer PWB (1.6 mm FR4) and measured at room temperature. See also (\*5)

(\*3) DC current which causes temperature rise of 40 K. Parts are soldered by reflow on multilayer PWB with high heat dissipation performance. Note: Heat radiation constant are approx. 23 K/W measured on 10.7×10.0×5.4 mm case size and approx. 26 K/W measured on 10.7×10.0×5.0 mm case size. See also (\*5)

(\*4) Saturation rated current : Dc current which causes L(0) drop -30 %.

(\*5) Within a suitable application, the part's temperature depends on circuit design and certain heat dissipation conditions. This should be double checked in a worst case operation mode.

In normal case, the max.standard operating temperature of +150 °C should not be exceeded.

For higher operating temperature conditions, please contact Panasonic representative in your area.

### Performance Characteristics (Reference)

#### ● Inductance vs DC Current

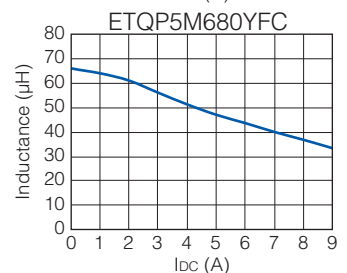
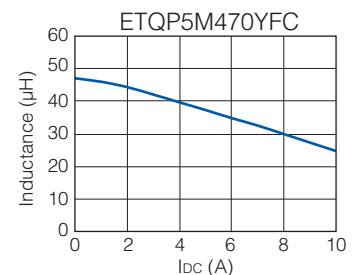
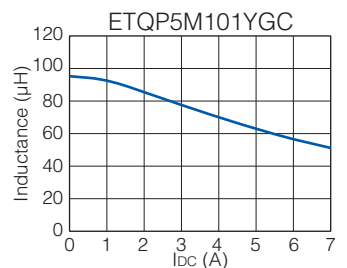
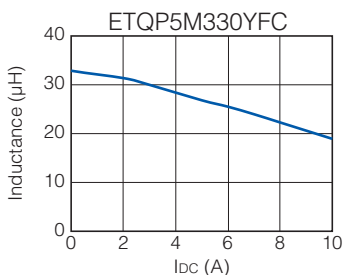
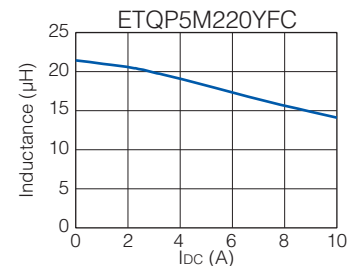
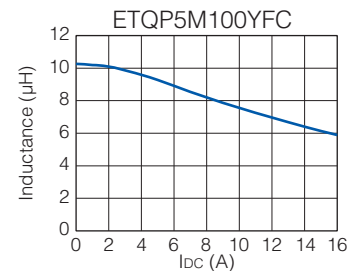
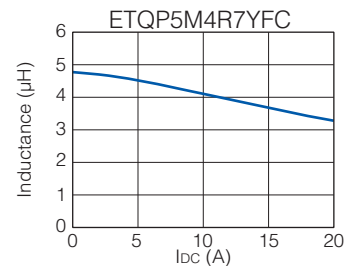
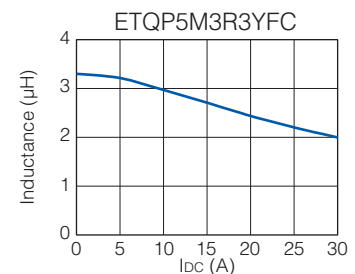
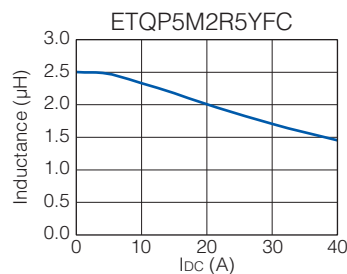
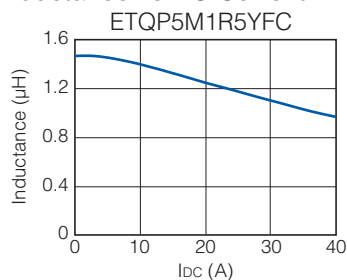

● Case Temperature vs DC Current

PWB condition A : Four-layer PWB (1.6 mm FR4), See also (\*2)

PWB condition B : Multilayer PWB with high heat dissipation performance. See also (\*3)

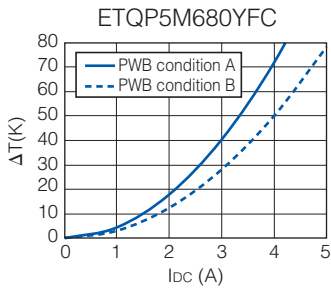
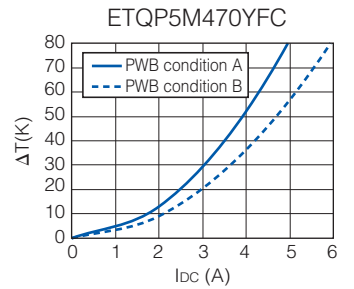
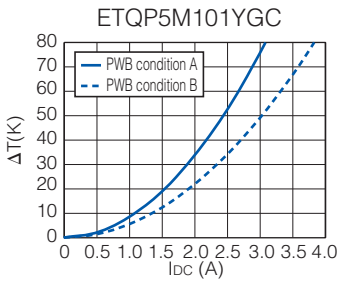
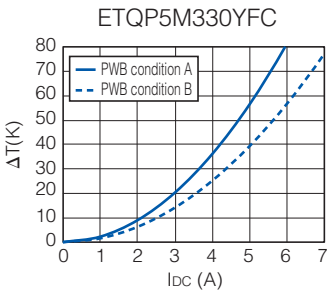
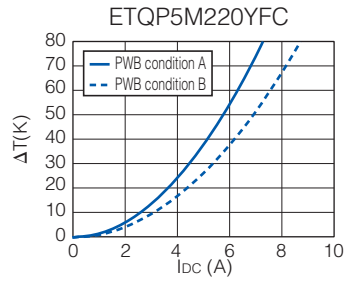
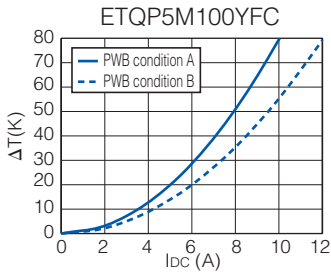
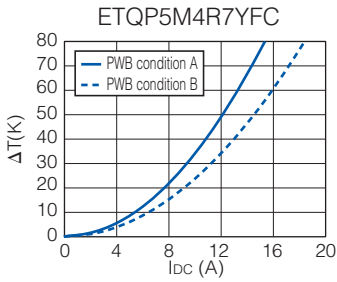
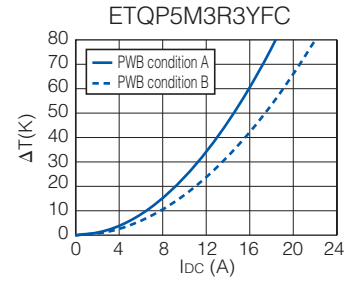
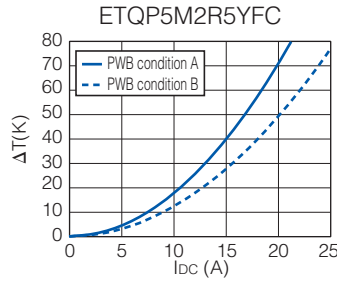
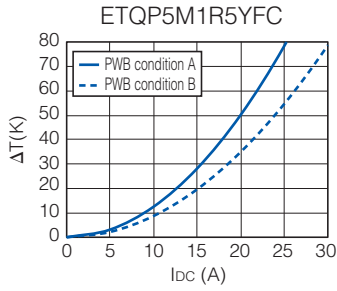

## 6. Series PCC-M1050ML/PCC-M1060ML (ETQP5M□□□YLC/ETQP6M□□□YLC)

### Standard Parts

Series	Part No.	Inductance *1		DCR (at 20 °C) (mΩ)		Rated Current (Typ. : A)		
		L0 (μH)	Tolerance (%)	Typ. (max.)	Tolerance (%)	ΔT=40K (*2)	ΔL=-30% (*3)	ΔL=-30% (*4)
PCC-M1050ML [10.9×10.0×5.0(mm)]	ETQP5MR68YLC	0.68	±20	1.75(1.93)	±10	26.3	31.5	42.0
	ETQP5M1R0YLC	1.0		2.3(2.53)		23.0	27.5	38.0
	ETQP5M2R0YLC	2.0		4.6(5.06)		16.2	19.4	22.7
PCC-M1060ML [10.9×10.0×6.0(mm)]	ETQP6M1R5YLC	1.5	±20	3.2(3.52)	±10	19.5	23.3	26.8
	ETQP6M2R5YLC	2.5		4.5(5.0)		16.3	19.6	27.0
	ETQP6M3R3YLC	3.3		6.0(6.6)		14.2	17.0	26.0
	ETQP6M4R7YLC	4.7		8.7(9.57)		11.8	14.1	13.2

(\*1) Measured at 100 kHz.

(\*2) DC current which causes temperature rise of 40 K. Parts are soldered by reflow on four-layer PWB (1.6 mm FR4) and measured at room temperature. See also (\*5)

(\*3) DC current which causes temperature rise of 40 K. Parts are soldered by reflow on multilayer PWB with high heat dissipation performance. Note: Heat radiation constant are approx. 23 K/W measured on 10.9×10.0×5.0 mm case size and approx. 23 K/W measured on 10.9×10.0×6.0 mm case size. See also (\*5)

(\*4) Saturation rated current : Dc current which causes L(0) drop -30 %.

(\*5) Within a suitable application, the part's temperature depends on circuit design and certain heat dissipation conditions. This should be double checked in a worst case operation mode.

In normal case, the max.standard operating temperature of +150 °C should not be exceeded.

For higher operating temperature conditions, please contact Panasonic representative in your area.

### Performance Characteristics (Reference)

#### ● Inductance vs DC Current

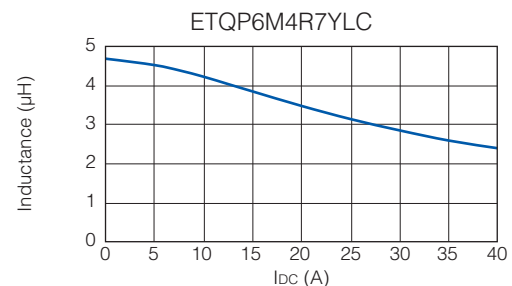
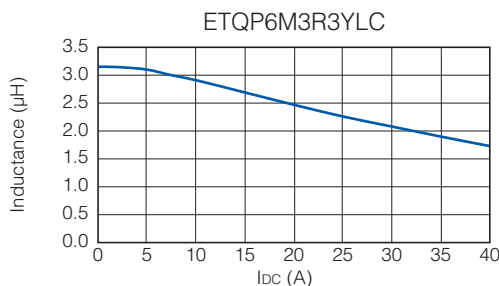
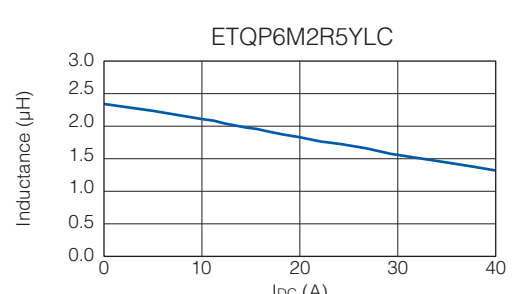
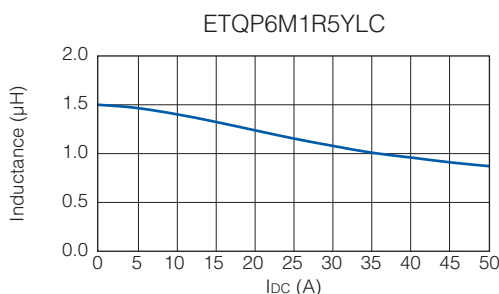
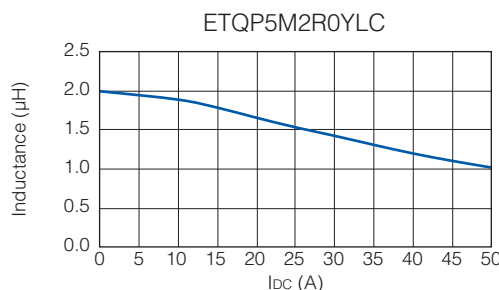
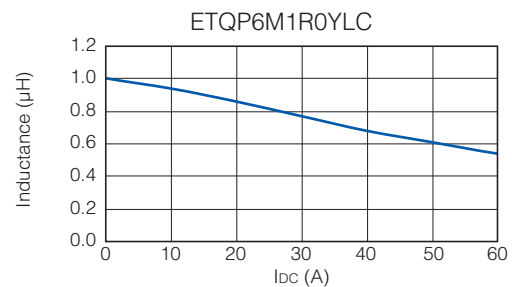
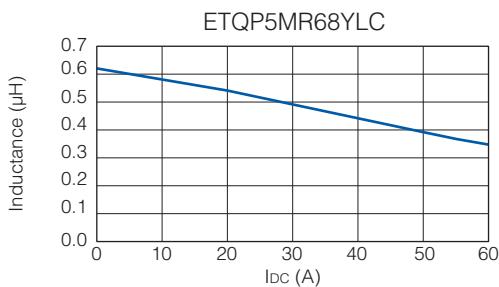

Design and specifications are each subject to change without notice. Ask factory for the current technical specifications before purchase and/or use.

Should a safety concern arise regarding this product, please be sure to contact us immediately.

● Case Temperature vs DC Current

PWB condition A : Four-layer PWB (1.6 mm FR4), See also (\*2)

PWB condition B : Multilayer PWB with high heat dissipation performance. See also (\*3)

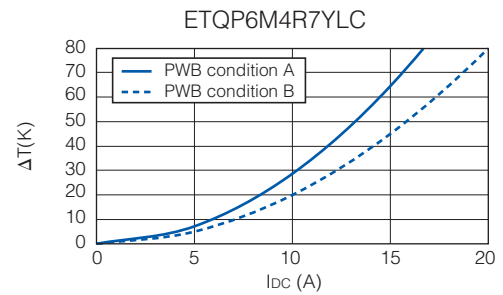
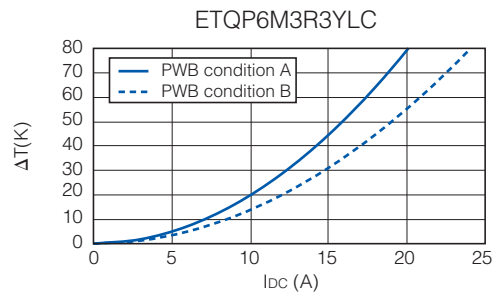
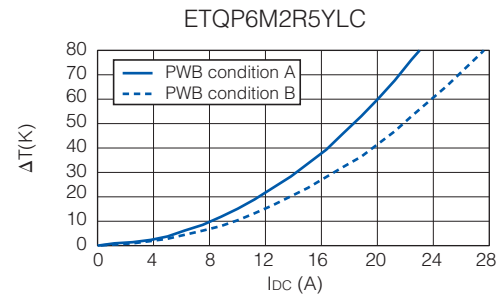
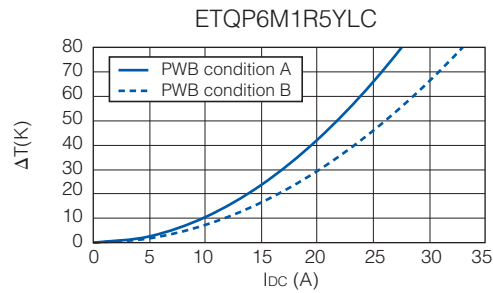
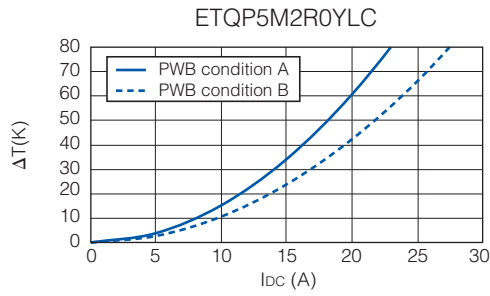
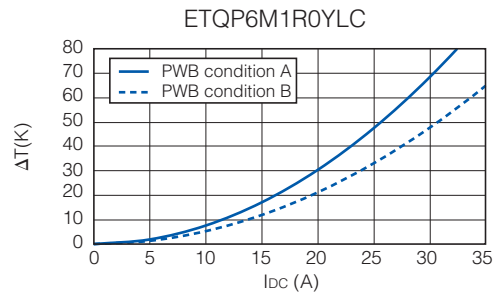
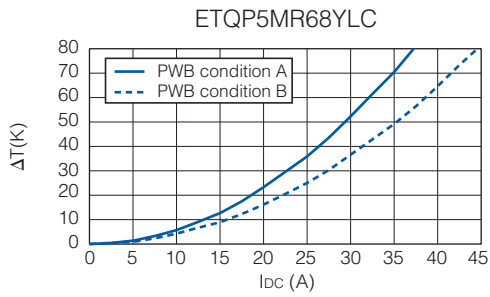

## Dimensions in mm (not to scale)

Dimensional tolerance unless noted :  $\pm 0.5$

Series PCC-M0530M  
Series PCC-M0540M  
(ETQP3M□□□YFP/ETQP4M□□□YFP)

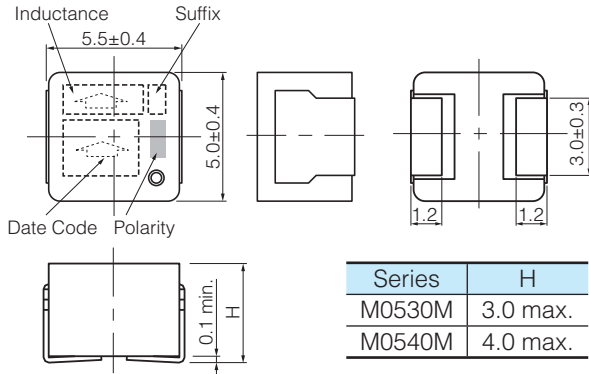

Series PCC-M0630M  
Series PCC-M0645M  
(ETQP3M□□□YFN/ETQP4M□□□YFN)

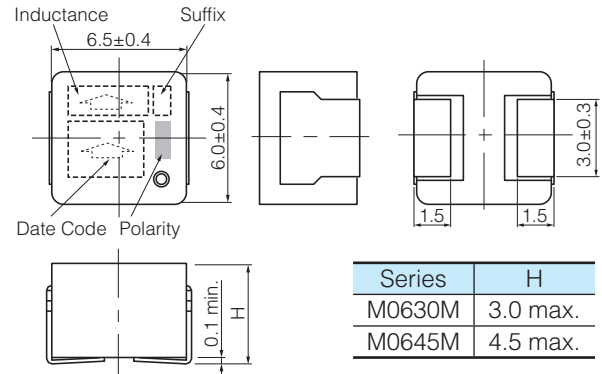

Series PCC-M0754M  
Series PCC-M0750M  
(ETQP5M□□□YFM/YGM)

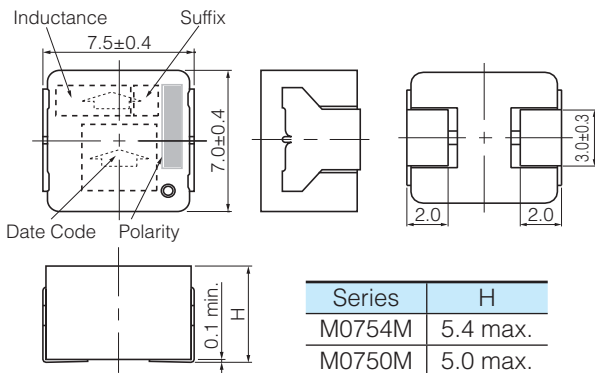

Series PCC-M0854M  
Series PCC-M0850M  
(ETQP5M□□□YFK/YGK)

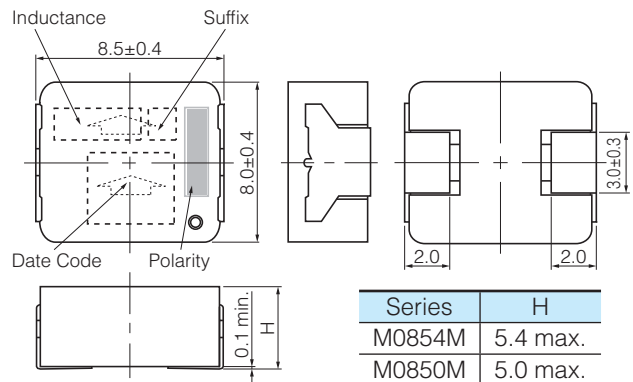

Series PCC-M1054M  
Series PCC-M1050M  
(ETQP5M□□□YFC/YGC)

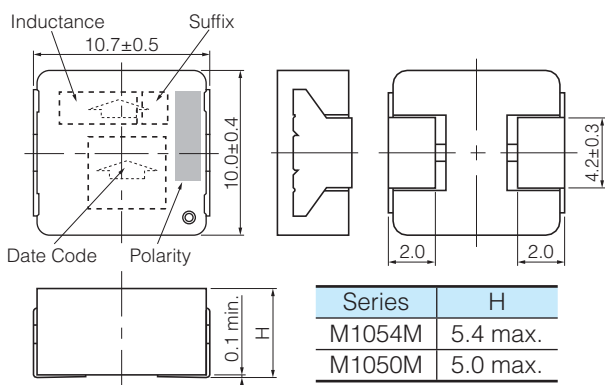

Series PCC-M1050ML  
Series PCC-M1060ML  
(ETQP5M□□□YLC/ETQP6M□□□YLC)

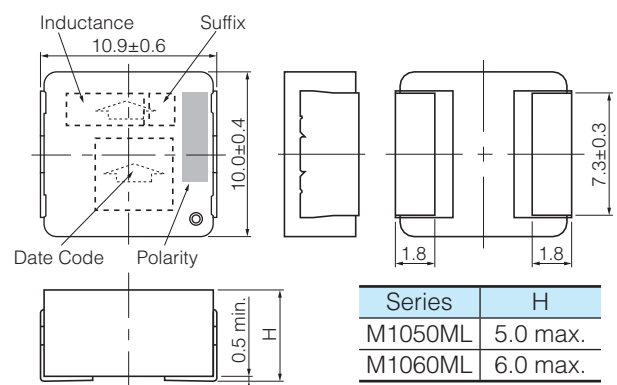

## Recommended Land Pattern in mm (not to scale)

Dimensional tolerance unless noted :  $\pm 0.5$

Series PCC-M0530M  
Series PCC-M0540M  
(ETQP3M□□□YFP/ETQP4M□□□YFP)

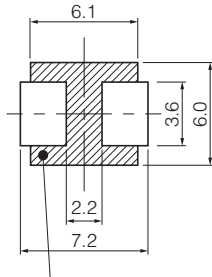

Don't wire on the pattern on shaded portion the PWB.

Series PCC-M0630M  
Series PCC-M0645M  
(ETQP3M□□□YFN/ETQP4M□□□YFN)

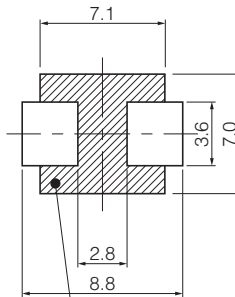

The same as the left.

Series PCC-M0754M  
Series PCC-M0750M  
(ETQP5M□□□YFM/YGM)

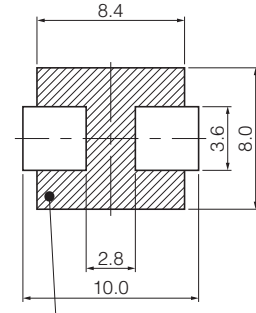

The same as the left.

Series PCC-M0854M  
Series PCC-M0850M  
(ETQP5M□□□YFK/YGK)

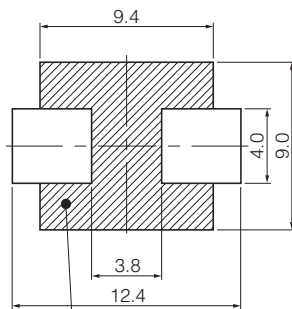

Don't wire on the pattern on shaded portion the PWB.

Series PCC-M1054M  
Series PCC-M1050M  
(ETQP5M□□□YFC/YGC)

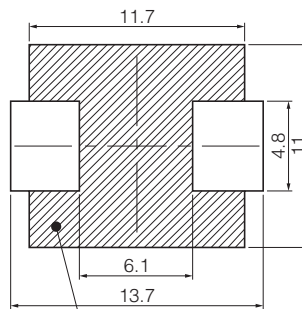

The same as the left.

Series PCC-M1050ML  
Series PCC-M1060ML  
(ETQP5M□□□YLC/ETQP6M□□□YLC)

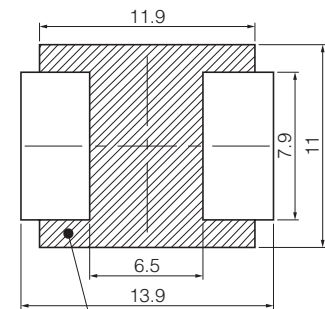

The same as the left.

## ■ As for Packaging Methods, Soldering Conditions and Safety Precautions (Power Choke Coils for Automotive application),

Please see Data Files

## Power Choke Coil for Automotive application

Series: **PCC-M1280MF (MC)**



High heat resistance and high reliability  
Using metal composite core (MC)

Industrial Property : patents 3 (Registered 1/Pending 2)

### Features

- High heat resistance : Operation up to 160 °C including self-heating
- Large current Power : 53 A (R33 type)
- High vibration resistance : 30G
- SMD type
- High-reliability : High vibration resistance as result of newly developed integral construction; under severe reliability conditions of automotive and other strenuous applications
- High bias current : Excellent inductance stability using ferrous alloy magnetic material (Fig.1)
- Temp. stability : Excellent inductance stability over broad temp. range
- Low audible (buzz) noise : New metal composite core technology
- High efficiency : Low  $R_{DC}$  of winding and low eddy-current loss of the core
- AEC-Q200 Automotive qualified
- RoHS compliant

● Fig.1 Inductance v.s. DC current

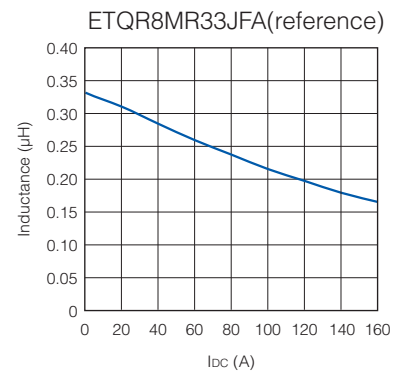

### Recommended Applications

- Noise filter for various drive circuitry requiring high temp. operation and peak current handling capability
- Boost-Converter, Buck-Converter DC/DC

### Standard Packing Quantity (Minimum Quantity/Packing Unit)

- 500 pcs./box (2 reel)

### Explanation of Part Numbers

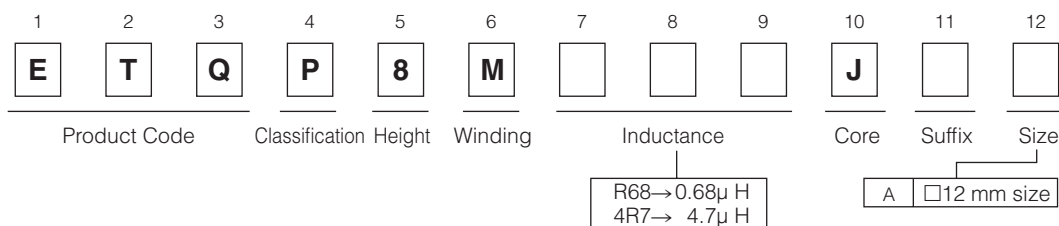

### Temperature rating

Operating temperature range		Tc : -40 °C to +160 °C(Including self-temperature rise)
Storage condition	After PWB mounting	
	Before PWB mounting	Ta : -5 °C to +35 °C 85%RH max.

## Standard Parts

Series	Part No.	Inductance *1		DCR (at 20 °C) (mΩ)		Rated Current (Typ. : A)		
		L0 (μH)	Tolerance (%)	Typ. (max.)	Tolerance (%)	ΔT=40K		ΔL=-30%
						(*2)	(*3)	(*4)
PCC-M1280MF [12.6×12.8×8.0(mm)]	▲ ETQP8MR33JFA	0.33	±20	0.70 (0.77)	±10	44.4	53.5	84.5
	ETQP8MR68JFA	0.68		1.10 (1.21)		35.4	42.6	56.9
	▲ ETQP8M1R0JFA	1.0		1.36 (1.50)		31.8	38.3	44.4
	▲ ETQP8M1R5JFA	1.5		1.80 (1.98)		27.7	33.3	29.9
	▲ ETQP8M2R5JFA	2.5		2.60 (2.86)		23.0	27.7	32.1
	▲ ETQP8M3R3JFA	3.3		3.60 (3.96)		19.6	23.6	27.6
	ETQP8M4R7JFA	4.7		4.90 (5.39)		16.8	20.2	24.7

- (\*1) Measured at 100k Hz. ▲ Under development
- (\*2) DC current which causes temperature rise of 40K. Parts are soldered by reflow on four-layer PWB (1.6 mm FR4) and measured at room temperature. See also (\*5)
- (\*3) DC current which causes temperature rise of 40K. Parts are soldered by reflow on multilayer PWB with high heat dissipation performance. Note: Heat radiation constant are approx. 20 K/W measured. See also (\*5)
- (\*4) Saturation rated current : DC current which causes L(0) drop -30 %.
- (\*5) Within a suitable application, the part's temperature depends on circuit design and certain heat dissipation conditions. This should be double checked in a worst case operation mode.  
In normal case, the max.standard operating temperature of +160 °C should not be exceeded.  
For higher operating temperature conditions, please contact Panasonic representative in your area.

## Performance Characteristics (Reference)

### ● Inductance vs DC Current

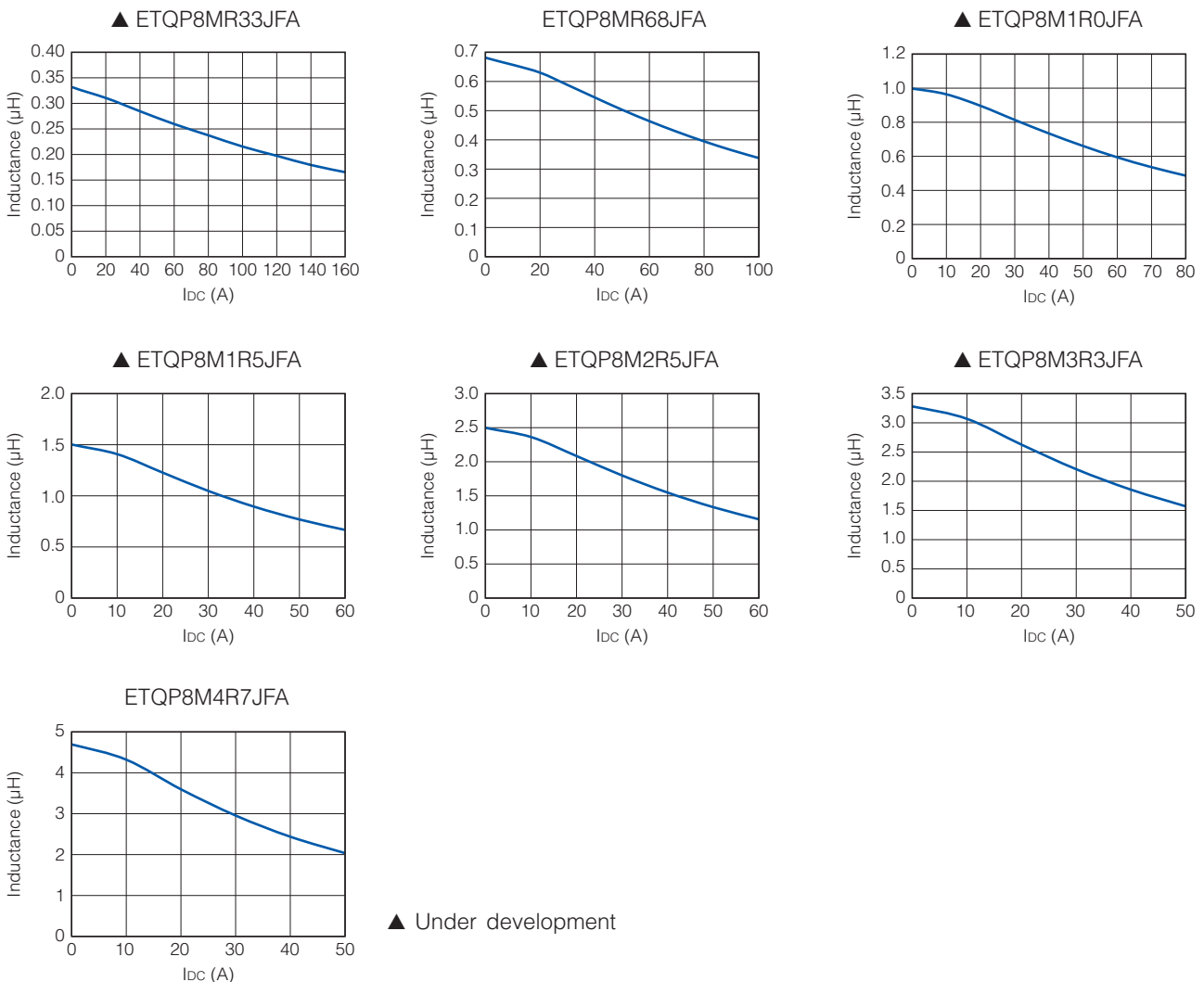



## Performance Characteristics (Reference)

### ● Case Temperature vs DC Current

PWB condition A : Four-layer PWB (1.6 mm FR4), See also (\*2)

PWB condition B : Multilayer PWB with high heat dissipation performance. See also (\*3)

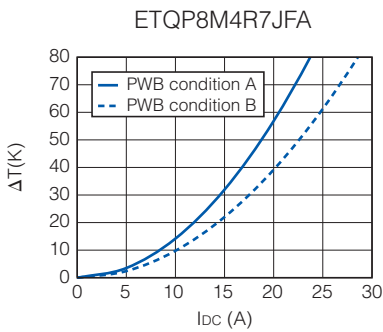
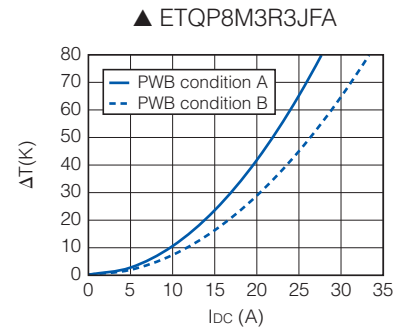
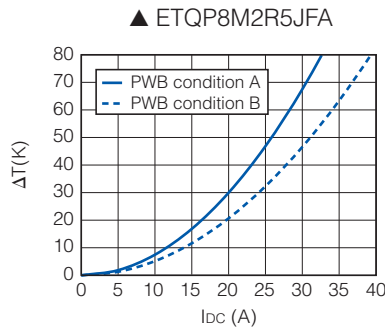
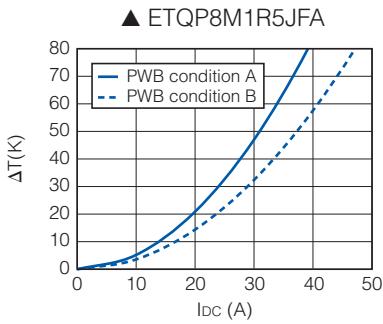
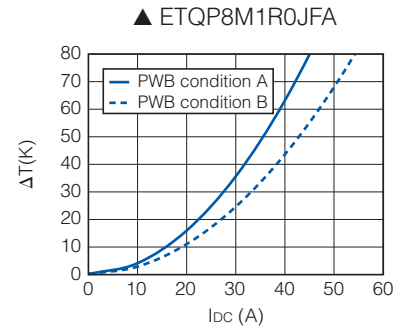
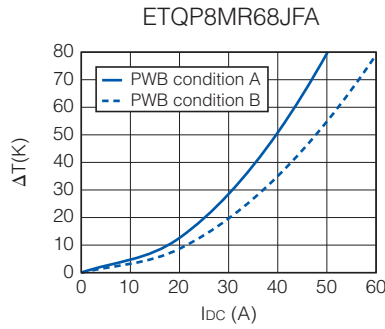
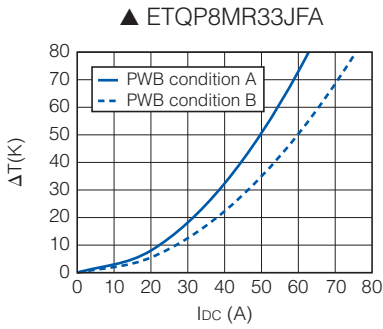

▲ Under development

## Dimensions in mm (not to scale)

Dimensional tolerance unless noted :  $\pm 0.5$

- ETQP8MR33JFA
- ETQP8M1R5JFA
- ETQP8M3R3JFA
- ETQP8MR68JFA
- ETQP8M2R5JFA
- ETQP8M4R7JFA
- ETQP8M1R0JFA

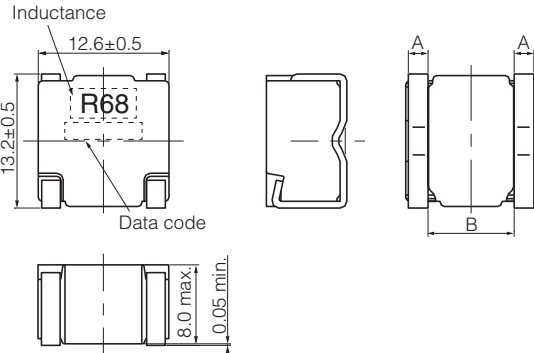

Part No.	A	B
ETQP8MR33JFA	2.15±0.4	7.3±1.0
ETQP8MR68JFA	2.1±0.4	8.0±1.0
ETQP8M1R0JFA	2.1±0.4	8.0±1.0
ETQP8M1R5JFA	2.1±0.4	8.0±1.0
ETQP8M2R5JFA	1.8±0.4	8.6±0.85

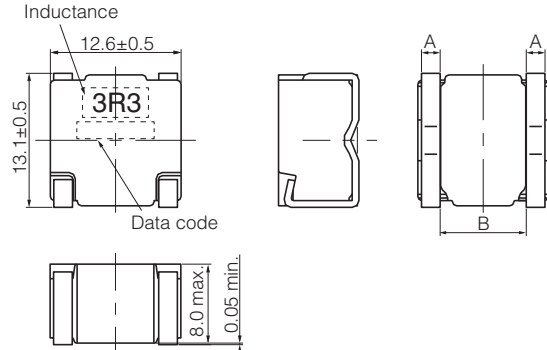

Part No.	A	B
ETQP8M3R3JFA	1.5±0.4	8.8±1.05
ETQP8M4R7JFA	1.25±0.4	9.0±1.25

## Recommended Land Pattern in mm (not to scale)

Dimensional tolerance unless noted :  $\pm 0.5$

### ● ETQP8MR33JFA

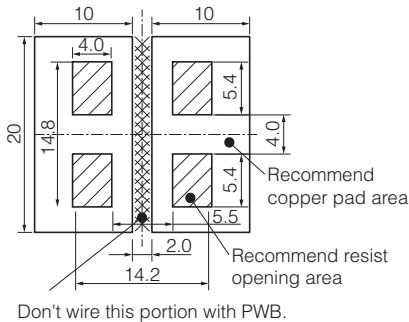

### ● ETQP8M4R7JFA

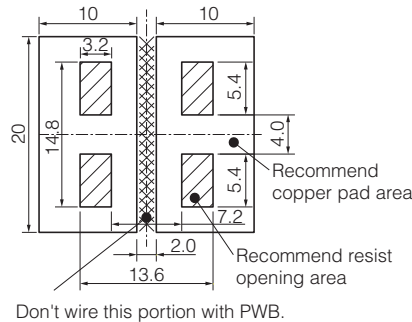

### ● ETQP8M3R3JFA

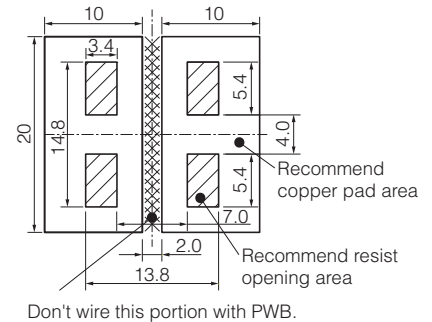

### ● ETQP8M2R5JFA

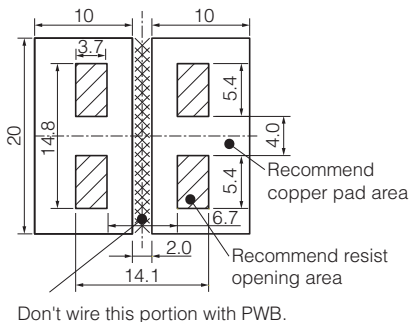

### ● ETQP8MR68JFA

### ● ETQP8M1R0JFA

### ● ETQP8M1R5JFA

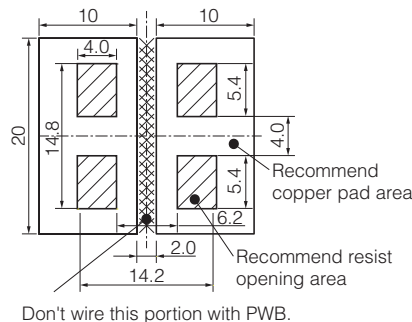

## ■ As for Soldering Conditions and Safety Precautions (Power Choke Coils for Automotive application),

Please see Data Files

## Packaging Methods (Taping)

- Embossed Carrier Tape Dimensions in mm (not to scale)
- Component Placement (Taping)

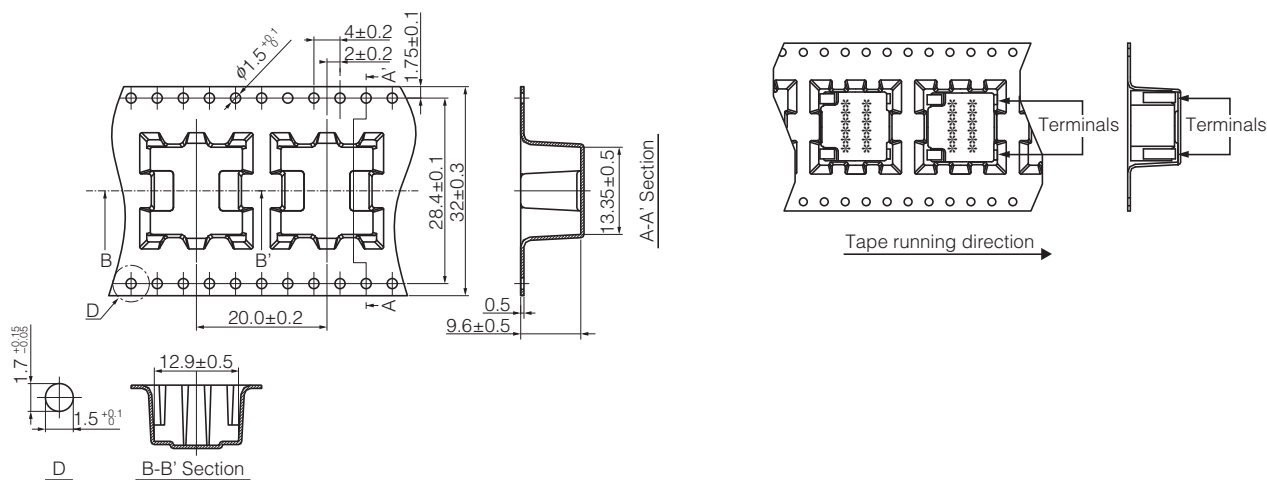

- Taping Reel Dimensions in mm (not to scale)

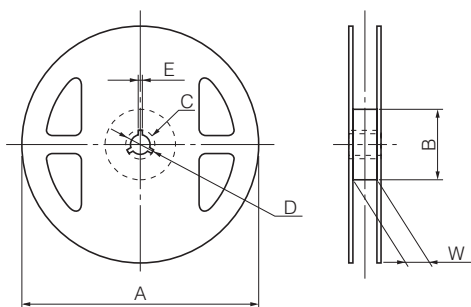

Standard Reel Dimensions

Series	A	B	C	D	E	W
PCC-M1280MF	330	(100)	13	21	2	33.5

## Power Choke Coil for Automotive application

Series: **PCC-M0530M-LP(MC)**  
**PCC-M0630M-LP(MC)**  
**PCC-M0840M-LP(MC)**  
**PCC-M1040M-LP(MC)**



High heat resistance and high reliability  
 Using metal composite core (MC)

Industrial Property : patents 3 (Registered 2/Pending 1)

### Features

- High heat resistance : Operation up to 155 °C including self-heating
- Low profile : 3 mm max. height (PCC-M0530M-LP, PCC-M0630M-LP)  
4 mm max. height (PCC-M0840M-LP, PCC-M1040M-LP)
- SMD type
- High-reliability : High vibration resistance as result of newly developed integral construction; under severe reliability conditions of automotive and other strenuous applications
- High bias current : Excellent inductance stability using ferrous alloy magnetic material (Fig.1)
- Temp. stability : Excellent inductance stability over broad temp. range
- Low audible (buzz) noise : New metal composite core technology
- High efficiency : Low  $R_{DC}$  of winding and low eddy-current loss of the core
- AEC-Q200 Automotive qualified
- RoHS compliant

● Fig.1 Inductance v.s. DC current

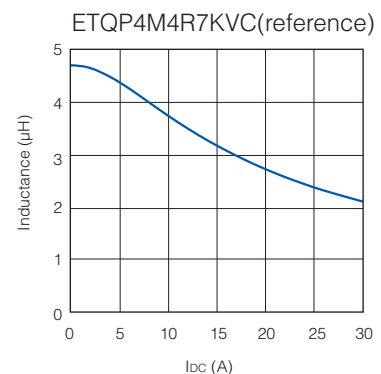

### Recommended Applications

- Noise filter for various drive circuitry requiring high temp. operation and peak current handling capability
- Boost-Converter, Buck-Converter DC/DC

### Standard Packing Quantity (Minimum Quantity/Packing Unit)

- 4,000 pcs./box (2 reel) : PCC-M0530M-LP, PCC-M0630M-LP
- 1,000 pcs./box (2 reel) : PCC-M0840M-LP, PCC-M1040M-LP

### Explanation of Part Numbers

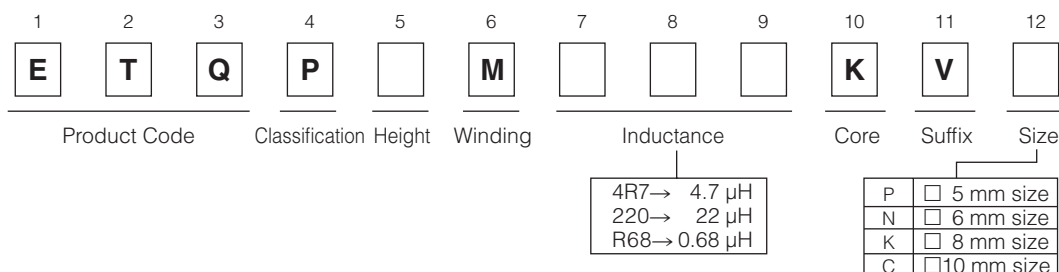

### Temperature rating

Operating temperature range		Tc : -55 °C to +155 °C(Including self-temperature rise)
Storage condition	After PWB mounting	
	Before PWB mounting	Ta : -5 °C to +35 °C 85%RH max.

Design and specifications are each subject to change without notice. Ask factory for the current technical specifications before purchase and/or use.  
 Should a safety concern arise regarding this product, please be sure to contact us immediately.

## 1. Series PCC-M0530M-LP (ETQP3M□□□KVP)

### Standard Parts

Series	Part No.	Inductance *1		DCR (at 20 °C) (mΩ)		Rated Current (Typ. : A)		
		L0 (μH)	Tolerance (%)	Typ. (max.)	Tolerance (%)	ΔT=40K		ΔL=-30%
						(*2)	(*3)	(*4)
PCC-M0530M-LP [5.5×5.0×3.0(mm)]	ETQP3M100KVP	10.00	±20	96 (105.6)	±10	2.4	2.9	4.2
	▲ETQP3M6R8KVP	6.80		65.7 (72.27)		2.9	3.5	6.1
	▲ETQP3M4R7KVP	4.70		45.6 (50.16)		3.4	4.1	6.7
	▲ETQP3M3R3KVP	3.30		27.3 (30.03)		4.4	5.4	8.0
	▲ETQP3M2R2KVP	2.20		20 (22)		5.2	6.3	10.1
	▲ETQP3M1R5KVP	1.50		12 (13.2)		6.7	8.1	12.0
	ETQP3M1R0KVP	1.00		9.6 (10.56)		7.5	9.0	14.1
	▲ETQP3MR68KVP	0.68		7.6 (8.36)		8.4	10.2	15.9

(\*1) Measured at 100k Hz.

(\*2) DC current which causes temperature rise of 40K. Parts are soldered by reflow on four-layer PWB (1.6 mm FR4) and measured at room temperature. See also (\*5)

(\*3) DC current which causes temperature rise of 40K. Parts are soldered by reflow on multilayer PWB with high heat dissipation performance. Note: Heat radiation constant are approx. 51 K/W measured on 5.5×5.0×3.0 mm case size. See also (\*5)

(\*4) Saturation rated current : DC current which causes L(0) drop -30 %.

(\*5) Within a suitable application, the part's temperature depends on circuit design and certain heat dissipation conditions. This should be double checked in a worst case operation mode.

In normal case, the max.standard operating temperature of +155 °C should not be exceeded.

For higher operating temperature conditions, please contact Panasonic representative in your area.

▲ Under development (Start of mass production : the 1st half of 2017) Please contact us for customized part no.

### Performance Characteristics (Reference)

#### ● Inductance vs DC Current

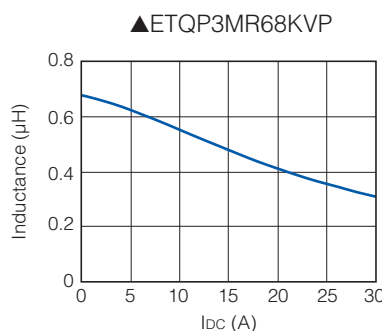
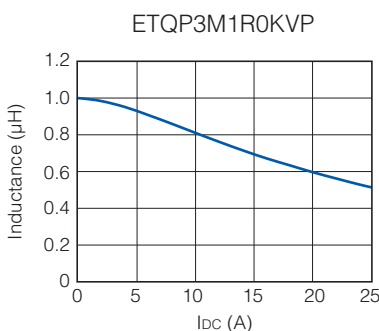
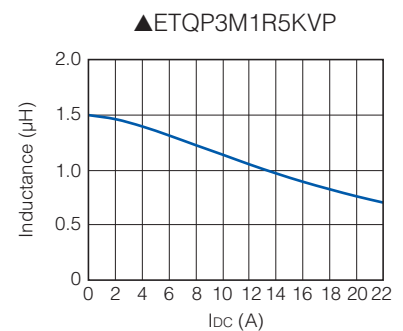
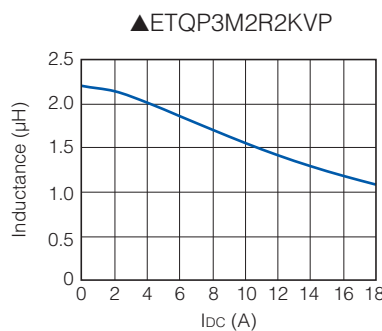
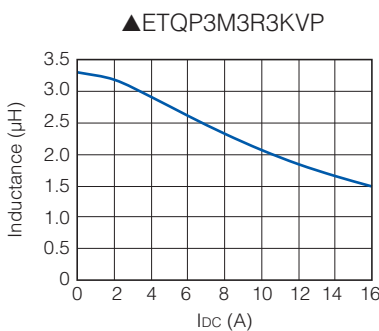
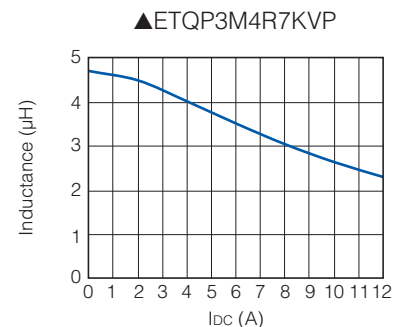
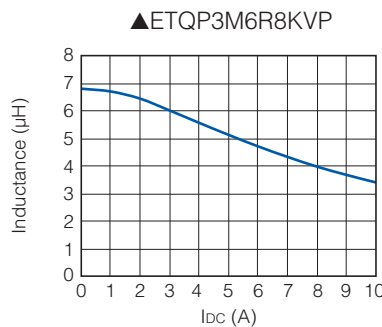
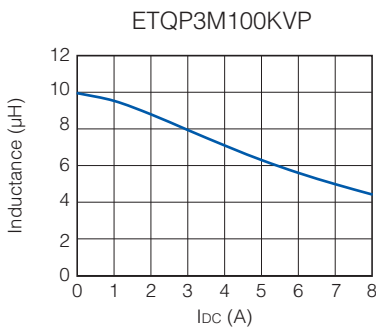

▲ Under development

## Performance Characteristics (Reference)

### ● Case Temperature vs DC Current

PWB condition A : Four-layer PWB (1.6 mm FR4), See also (\*2)

PWB condition B : Multilayer PWB with high heat dissipation performance. See also (\*3)

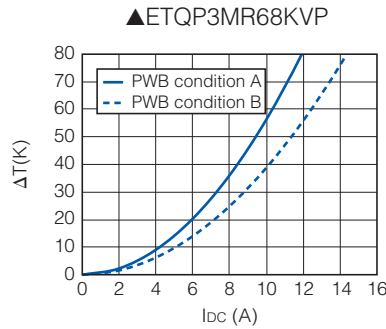
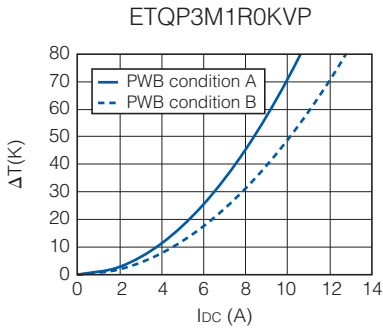
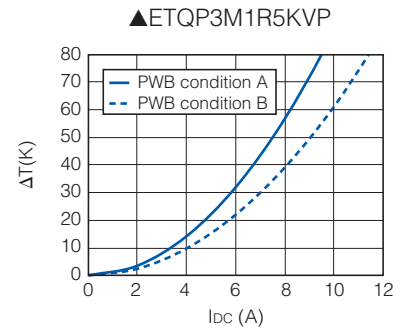
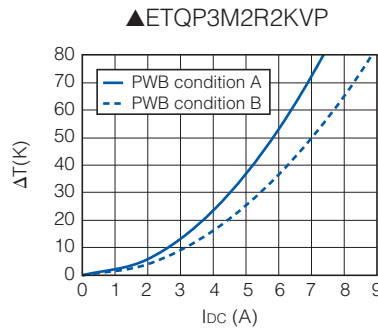
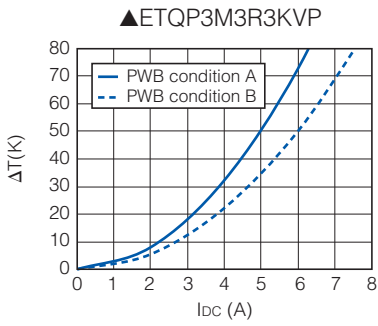
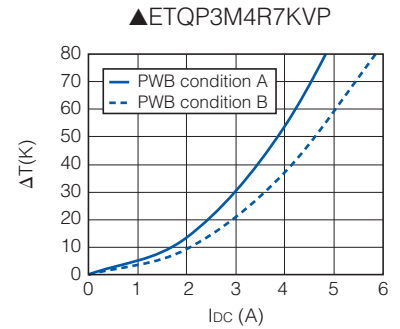
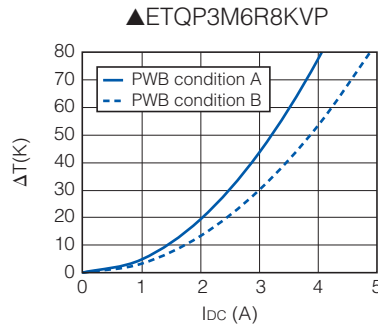
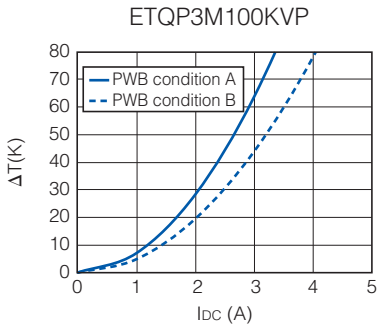

▲ Under development

## 2. Series PCC-M0630M-LP (ETQP3M□□□KVN)

### Standard Parts

Series	Part No.	Inductance *1		DCR (at 20 °C) (mΩ)		Rated Current (Typ. : A)		
		L0 (μH)	Tolerance (%)	Typ. (max.)	Tolerance (%)	ΔT=40K		ΔL=-30%
						(*2)	(*3)	(*4)
PCC-M0630M-LP [6.5×6.0×3.0(mm)]	▲ETQP3M220KVN	22.00	±20	128 (140.8)	±10	2.2	2.7	4.3
	▲ETQP3M150KVN	15.00		99.2 (109.12)		2.5	3.0	5.1
	ETQP3M100KVN	10.00		71 (78.1)		2.9	3.6	6.1
	ETQP3M6R8KVN	6.80		45.6 (50.16)		3.6	4.5	8.1
	▲ETQP3M4R7KVN	4.70		29 (31.9)		4.6	5.6	9.8
	▲ETQP3M3R3KVN	3.30		24.1 (26.51)		5.0	6.1	11.5
	▲ETQP3M2R2KVN	2.20		14.5 (15.95)		6.5	7.9	12.8
	▲ETQP3M1R5KVN	1.50		11 (12.1)		7.4	9.1	14.2
	▲ETQP3M1R0KVN	1.00		6.2 (6.82)		9.9	12.1	16.0
	▲ETQP3MR68KVN	0.68		5.2 (5.72)		10.8	13.2	20.2

(\*1) Measured at 100k Hz.

(\*2) DC current which causes temperature rise of 40K. Parts are soldered by reflow on four-layer PWB (1.6 mm FR4) and measured at room temperature. See also (\*5)

(\*3) DC current which causes temperature rise of 40K. Parts are soldered by reflow on multilayer PWB with high heat dissipation performance. Note: Heat radiation constant are approx. 44 K/W measured on 6.5×6.0×3.0 mm case size. See also (\*5)

(\*4) Saturation rated current : DC current which causes L(0) drop -30 %.

(\*5) Within a suitable application, the part's temperature depends on circuit design and certain heat dissipation conditions. This should be double checked in a worst case operation mode.

In normal case, the max.standard operating temperature of +155 °C should not be exceeded.

For higher operating temperature conditions, please contact Panasonic representative in your area.

▲ Under development (Start of mass production : the 1st half of 2017) Please contact us for customized part no.

### Performance Characteristics (Reference)

#### ● Inductance vs DC Current

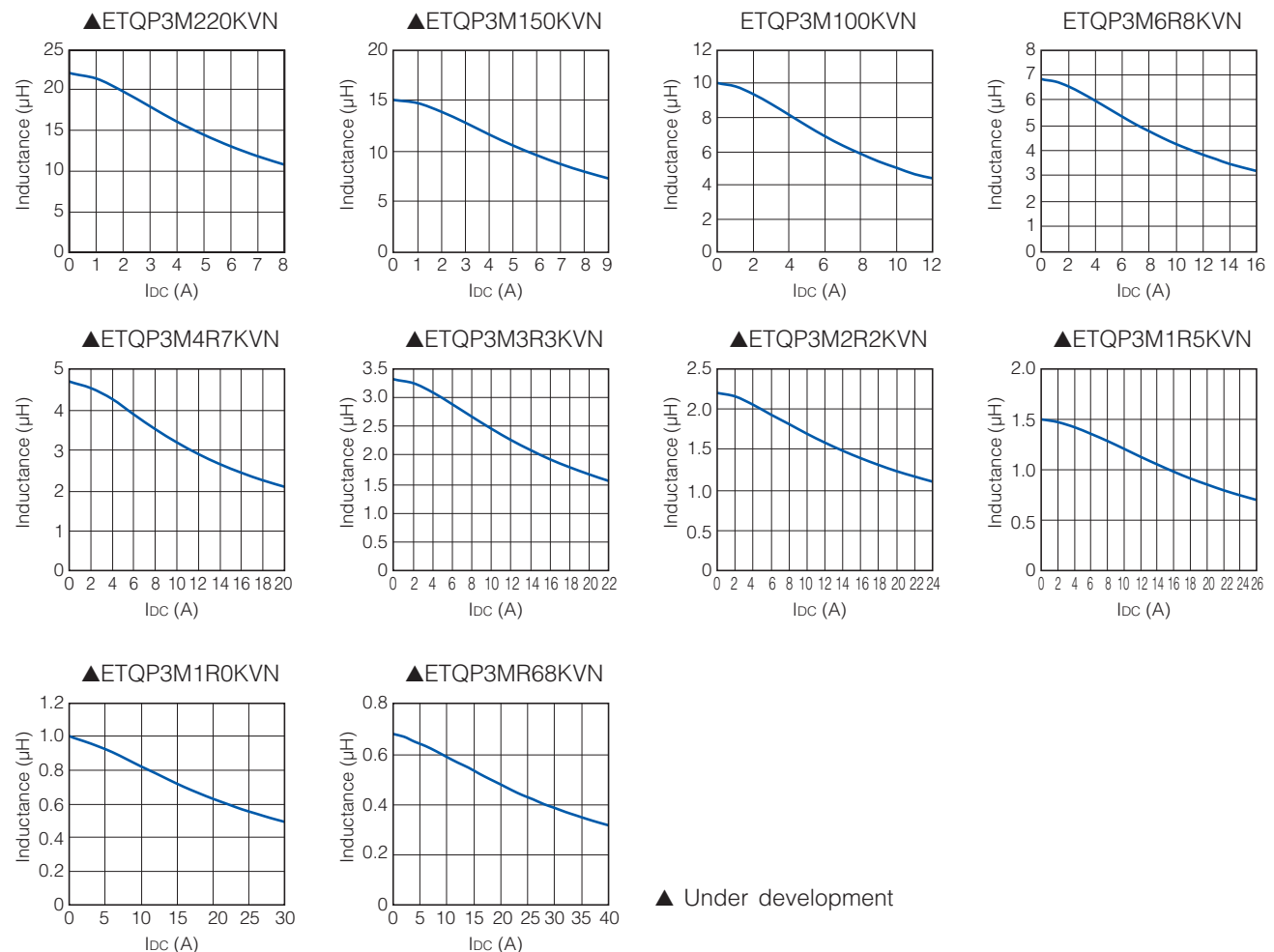

## Performance Characteristics (Reference)

### ● Case Temperature vs DC Current

PWB condition A : Four-layer PWB (1.6 mm FR4), See also (\*2)

PWB condition B : Multilayer PWB with high heat dissipation performance. See also (\*3)

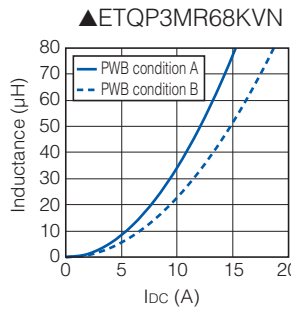
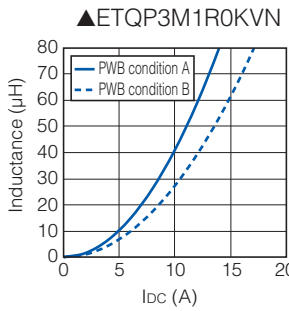
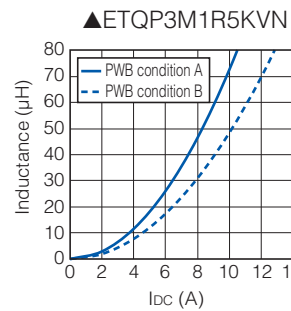
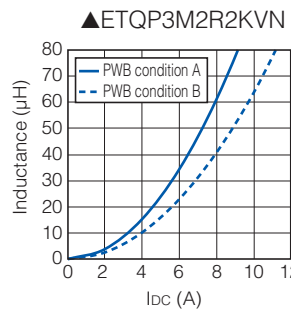
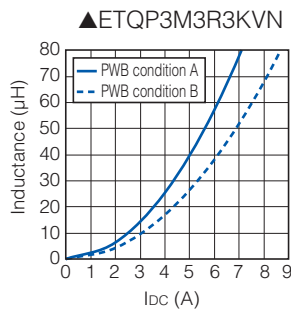
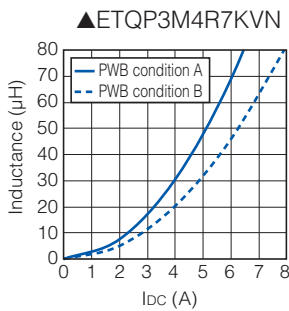
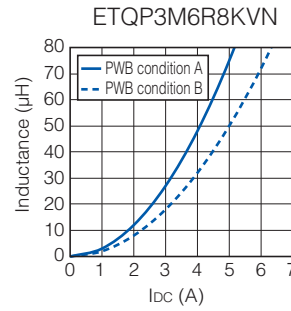
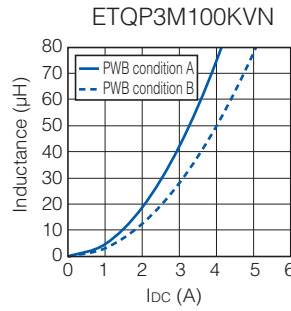
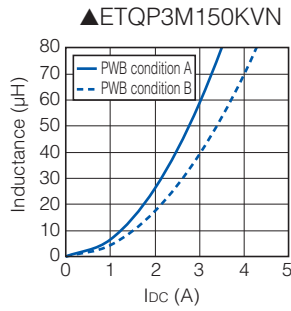
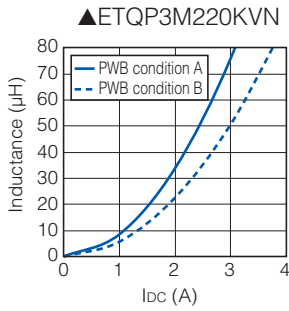

▲ Under development



### 3. Series PCC-M0840M-LP (ETQP4M□□□KVK)

#### Standard Parts

Series	Part No.	Inductance *1		DCR (at 20 °C) (mΩ)		Rated Current (Typ. : A)		
		L0 (μH)	Tolerance (%)	Typ. (max.)	Tolerance (%)	ΔT=40K		ΔL=-30%
						(*2)	(*3)	(*4)
PCC-M0840M-LP [8.5×8.0×4.0(mm)]	▲ETQP4M330KVK	33.00	±20	118 (129.8)	±10	2.6	3.1	5.3
	▲ETQP4M220KVK	22.00		76.3 (83.93)		3.3	3.8	6.7
	▲ETQP4M150KVK	15.00		55 (60.5)		3.8	4.5	7.7
	▲ETQP4M100KVK	10.00		41.6 (45.76)		4.4	5.2	9.1
	▲ETQP4M6R8KVK	6.80		23.5 (25.85)		5.9	6.9	11.0
	ETQP4M4R7KVK	4.70		16.1 (17.71)		7.1	8.3	15.1
	▲ETQP4M3R3KVK	3.30		14 (15.4)		7.6	8.9	17.4
	▲ETQP4M2R2KVK	2.20		8.5 (9.35)		9.8	11.4	20.4
	▲ETQP4M1R5KVK	1.50		4.9 (5.39)		12.8	15.1	22.5
	▲ETQP4M1R0KVK	1.00		3.7 (4.07)		14.8	17.3	24.4
▲ETQP4MR68KVK	0.68	2.9 (3.19)	16.7	19.6	29.0			

(\*1) Measured at 100k Hz.

(\*2) DC current which causes temperature rise of 40K. Parts are soldered by reflow on four-layer PWB (1.6 mm FR4) and measured at room temperature. See also (\*5)

(\*3) DC current which causes temperature rise of 40K. Parts are soldered by reflow on multilayer PWB with high heat dissipation performance. Note: Heat radiation constant are approx. 36 K/W measured on 8.5×8.0×4.0 mm case size. See also (\*5)

(\*4) Saturation rated current : DC current which causes L(0) drop -30 %.

(\*5) Within a suitable application, the part's temperature depends on circuit design and certain heat dissipation conditions. This should be double checked in a worst case operation mode.

In normal case, the max.standard operating temperature of +155 °C should not be exceeded.

For higher operating temperature conditions, please contact Panasonic representative in your area.

▲ Under development (Start of mass production: the 2nd half of 2017) Please contact us for customized part no.

#### Performance Characteristics (Reference)

##### ● Inductance vs DC Current

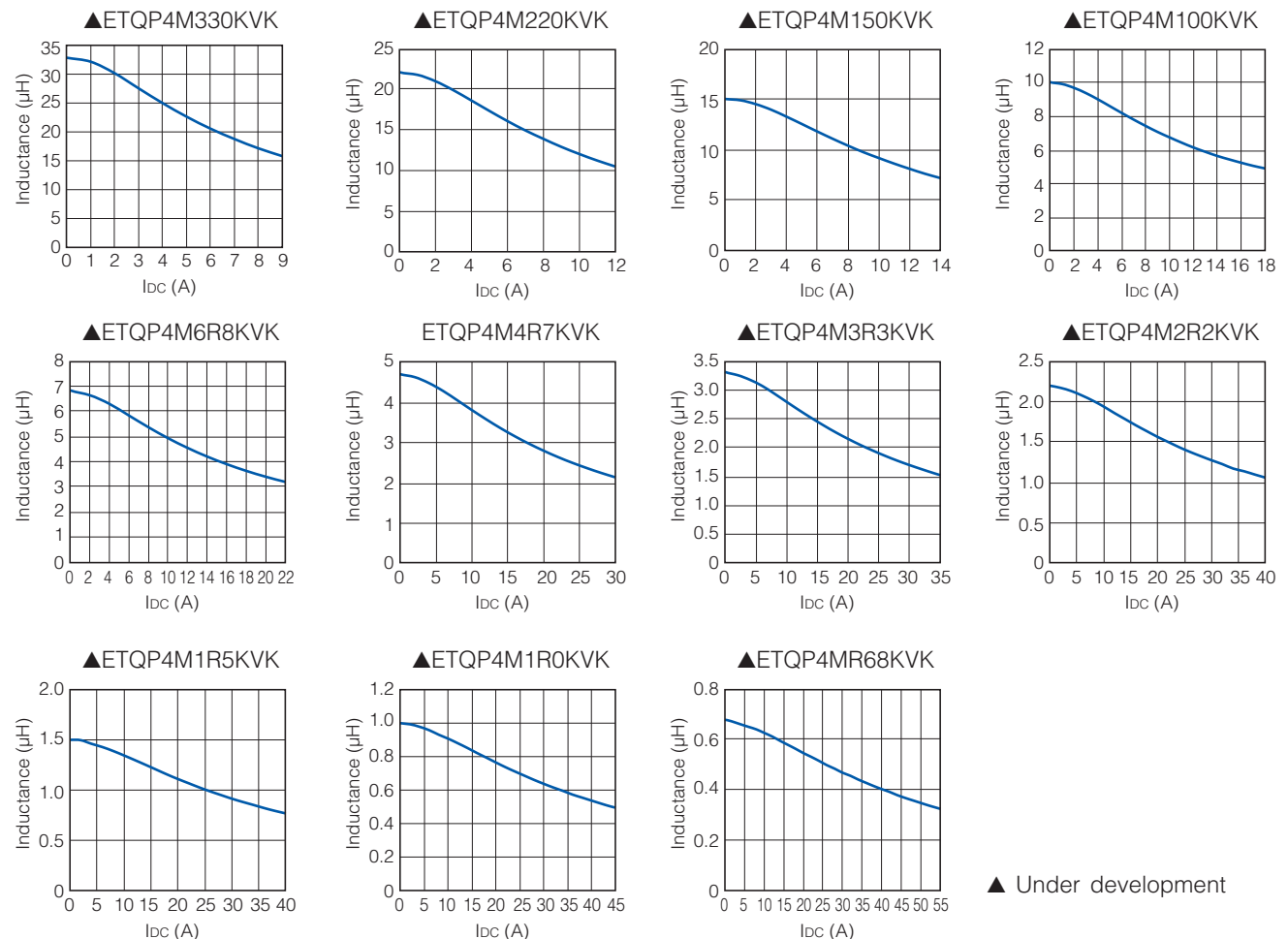

## Performance Characteristics (Reference)

### ● Case Temperature vs DC Current

PWB condition A : Four-layer PWB (1.6 mm FR4), See also (\*2)

PWB condition B : Multilayer PWB with high heat dissipation performance. See also (\*3)

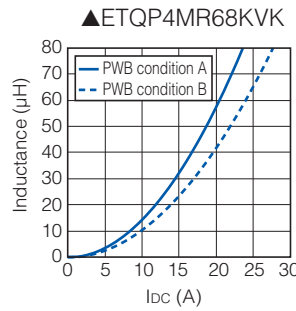
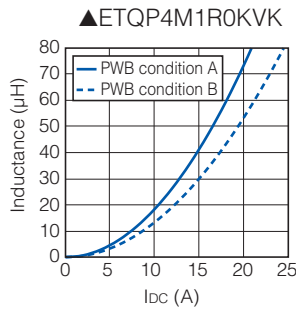
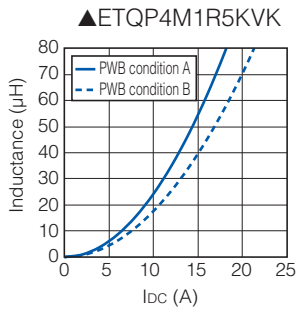
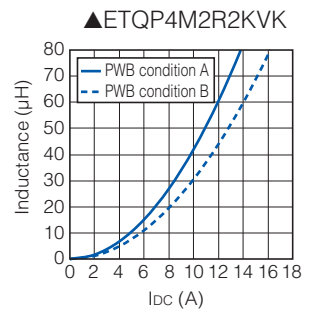
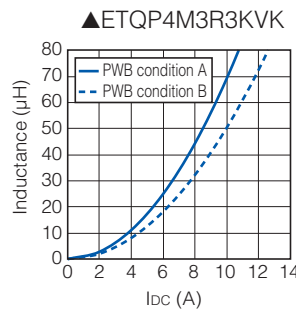
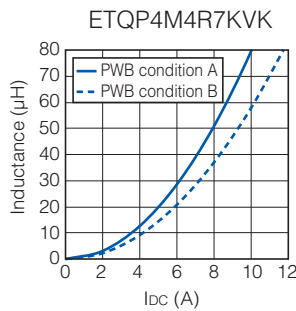
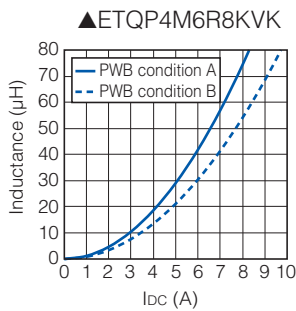
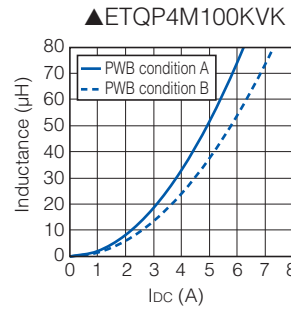
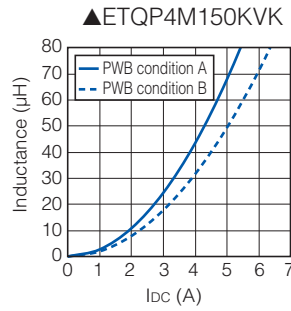
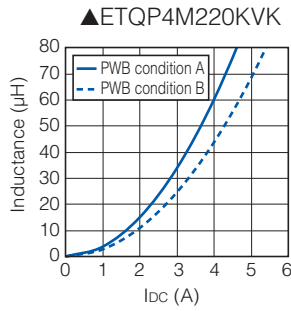
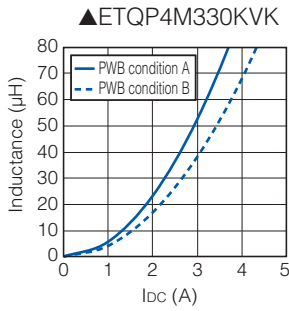

▲ Under development

## 4. Series PCC-M1040M-LP (ETQP4M□□□KVC)

### Standard Parts

Series	Part No.	Inductance *1		DCR (at 20 °C) (mΩ)		Rated Current (Typ. : A)		
		L0 (μH)	Tolerance (%)	Typ. (max.)	Tolerance (%)	ΔT=40K		ΔL=-30%
						(*2)	(*3)	(*4)
PCC-M1040M-LP [10.7×10.0×4.0(mm)]	▲ETQP4M470KVC	47.00	±20	132 (145.2)	±10	2.8	3.4	4.7
	▲ETQP4M330KVC	33.00		84.6 (93.06)		3.4	4.2	5.6
	▲ETQP4M220KVC	22.00		60 (66)		4.1	5.0	7.4
	▲ETQP4M150KVC	15.00		37 (40.7)		5.2	6.3	9.2
	▲ETQP4M100KVC	10.00		25.4 (27.94)		6.3	7.6	10.8
	▲ETQP4M6R8KVC	6.80		18.5 (20.35)		7.4	8.9	12.1
	▲ETQP4M4R7KVC	4.70		11.8 (12.98)		9.2	11.2	13.9
	▲ETQP4M3R3KVC	3.30		9.4 (10.34)		10.3	12.6	17.1
	▲ETQP4M2R2KVC	2.20		6.8 (7.48)		12.1	14.8	21.0
	▲ETQP4M1R5KVC	1.50		4.9 (5.39)		14.3	17.4	25.0
▲ETQP4M1R0KVC	1.00	2.6 (2.86)	19.6	23.9	34.6			

(\*1) Measured at 100k Hz.

(\*2) DC current which causes temperature rise of 40K. Parts are soldered by reflow on four-layer PWB (1.6 mm FR4) and measured at room temperature. See also (\*5)

(\*3) DC current which causes temperature rise of 40K. Parts are soldered by reflow on multilayer PWB with high heat dissipation performance. Note: Heat radiation constant are approx. 27 K/W measured on 10.7×10.0×4.0 mm case size. See also (\*5)

(\*4) Saturation rated current : DC current which causes L(0) drop -30 %.

(\*5) Within a suitable application, the part's temperature depends on circuit design and certain heat dissipation conditions. This should be double checked in a worst case operation mode.

In normal case, the max.standard operating temperature of +155 °C should not be exceeded.

For higher operating temperature conditions, please contact Panasonic representative in your area.

▲ Under development (Start of mass production: the 2nd half of 2017) Please contact us for customized part no.

### Performance Characteristics (Reference)

#### ● Inductance vs DC Current

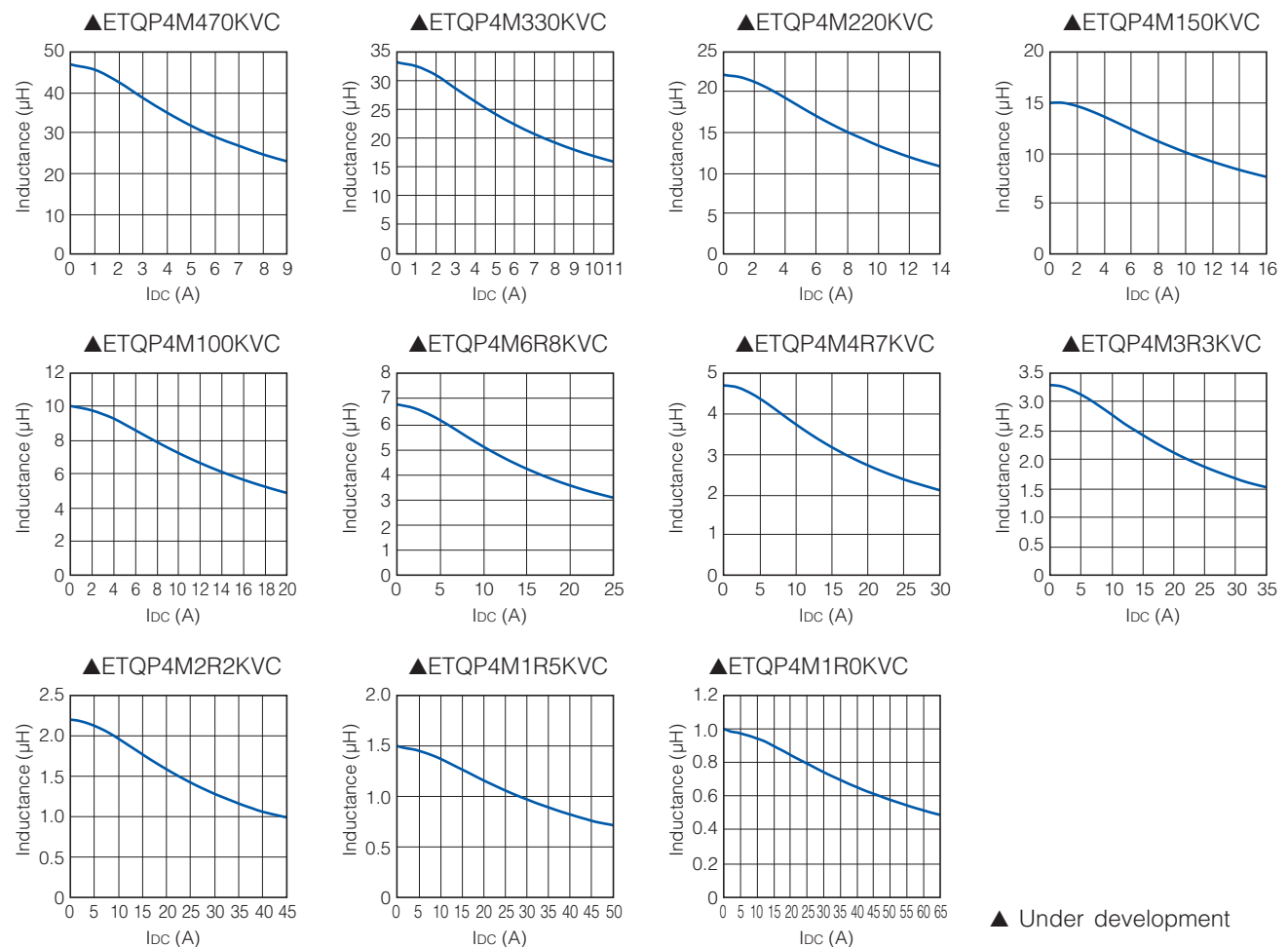

## Performance Characteristics (Reference)

### ● Case Temperature vs DC Current

PWB condition A : Four-layer PWB (1.6 mm FR4), See also (\*2)

PWB condition B : Multilayer PWB with high heat dissipation performance. See also (\*3)

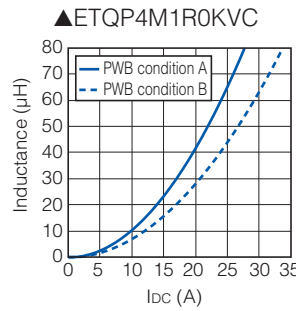
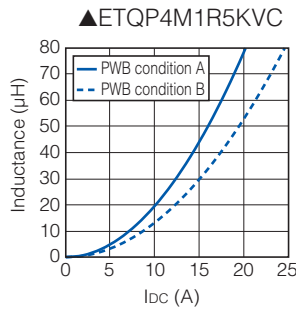
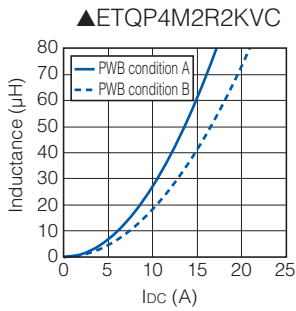
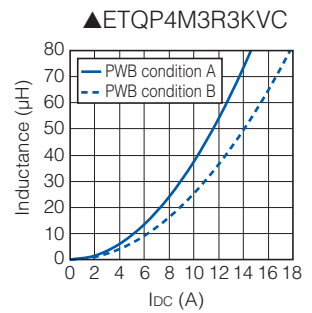
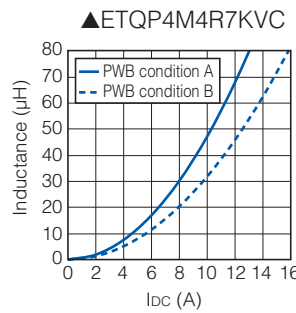
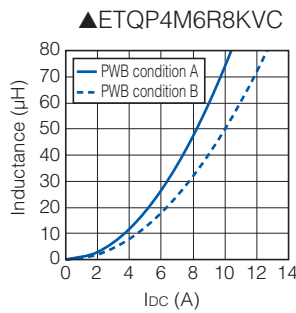
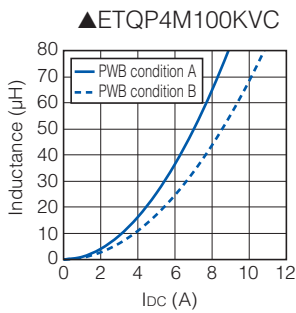
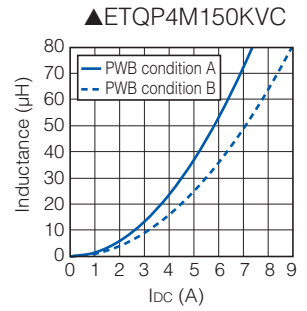
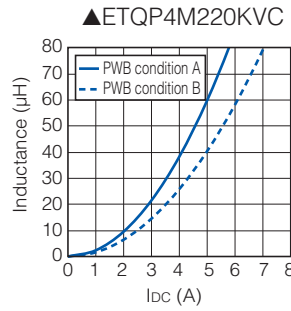
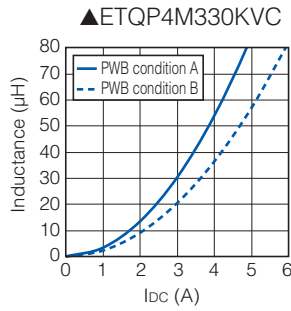
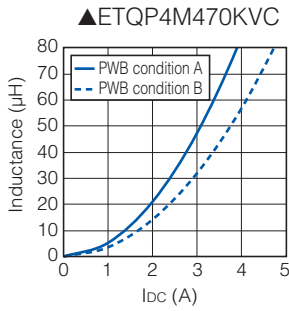

▲ Under development

## Dimensions in mm (not to scale)

Dimensional tolerance unless noted :  $\pm 0.5$

**Series PCC-M0530M-LP**  
(ETQP3M□□□KVP)

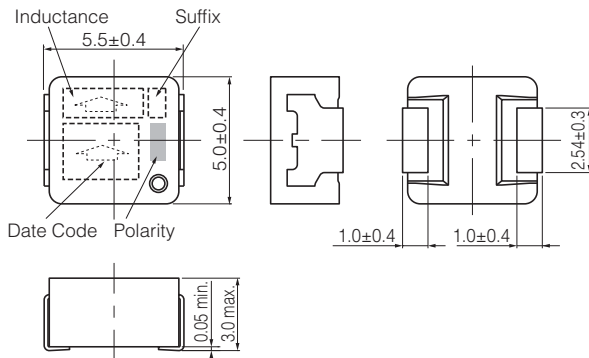

**Series PCC-M0630M-LP**  
(ETQP3M□□□KVN)

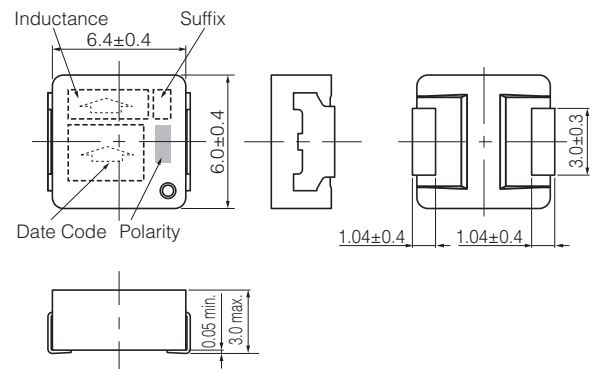

**Series PCC-M0840M-LP**  
(ETQP4M□□□KVK)

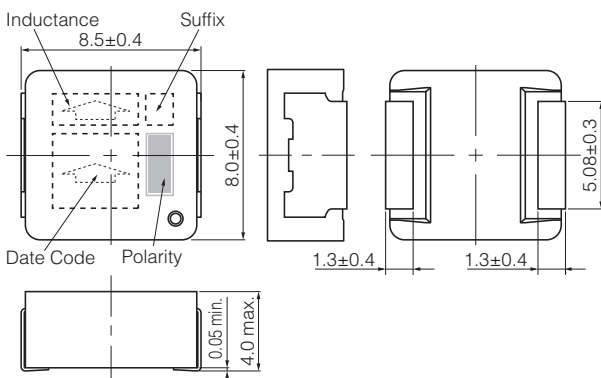

**Series PCC-M1040M-LP**  
(ETQP4M□□□\*KVC)  
\* Exemption "1R0"

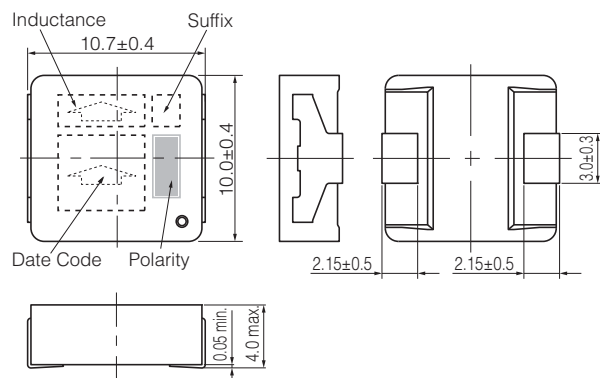

**Series PCC-M1040M-LP**  
(ETQP4M1R0KVC)

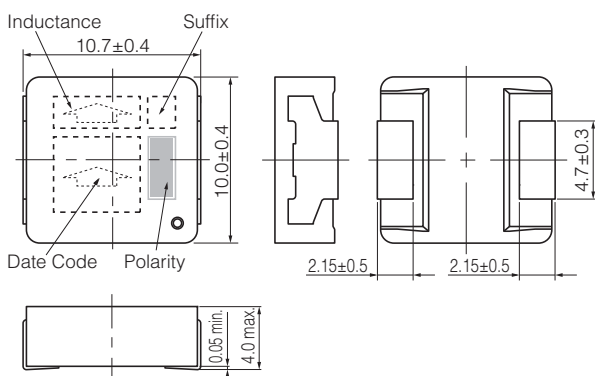

## Recommended Land Pattern in mm (not to scale)

Dimensional tolerance unless noted :  $\pm 0.5$

Series PCC-M0530M-LP  
(ETQP3M□□□KVP)

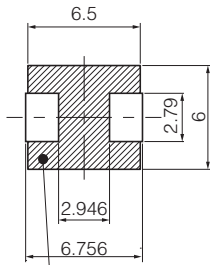

Don't wire on the pattern on shaded portion the PWB.

Series PCC-M0630M-LP  
(ETQP3M□□□KVN)

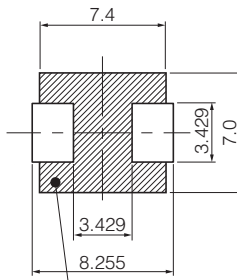

The same as the left.

Series PCC-M0840M-LP  
(ETQP4M□□□KVK)

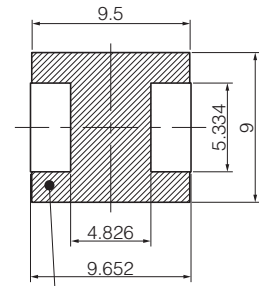

The same as the left.

Series PCC-M1040M-LP  
(ETQP4M□□□\*KVC)  
\* Exemption "1R0"

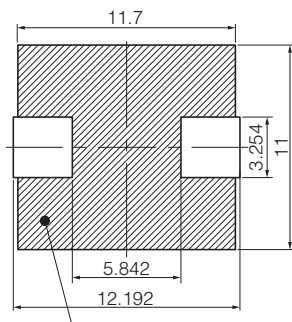

Don't wire on the pattern on shaded portion the PWB.

Series PCC-M1040M-LP  
(ETQP4M1R0KVC)

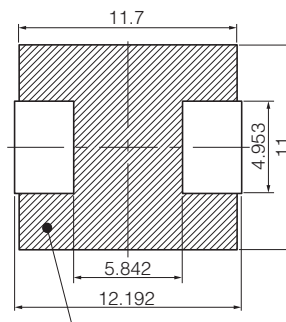

The same as the left.

### ■ As for Soldering Conditions and Safety Precautions (Power Choke Coils for Automotive application),

Please see Data Files

## Packaging Methods (Taping)

- Embossed Carrier Tape Dimensions in mm (not to scale)

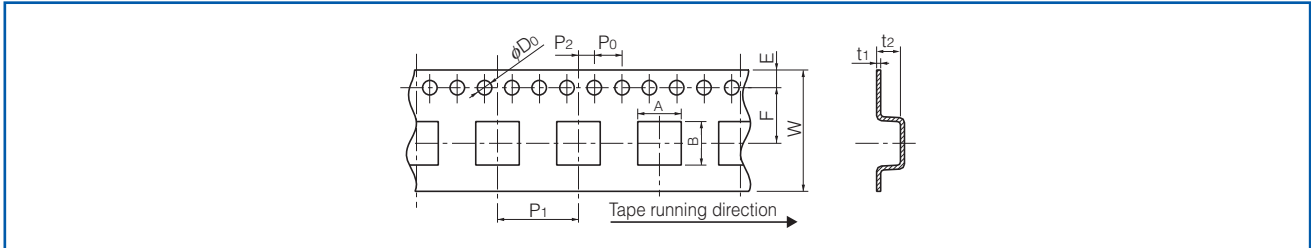

Series	A	B	W	E	F	P <sub>1</sub>	P <sub>2</sub>	P <sub>0</sub>	φD <sub>0</sub>	t <sub>1</sub>	t <sub>2</sub>
PCC-M0530M-LP	5.6	6.1	16	1.75	7.5	8	2	4	1.5	0.3	3.3
PCC-M0630M-LP	6.5	7.1	16	1.75	7.5	8	2	4	1.5	0.3	3.3
PCC-M0840M-LP	8.63	9.1	16	1.75	7.5	12	2	4	1.5	0.4	6.0
PCC-M1040M-LP	10.65	11.75	24	1.75	11.5	16	2	4	1.5	0.5	6.35

- Taping Reel Dimensions in mm (not to scale)

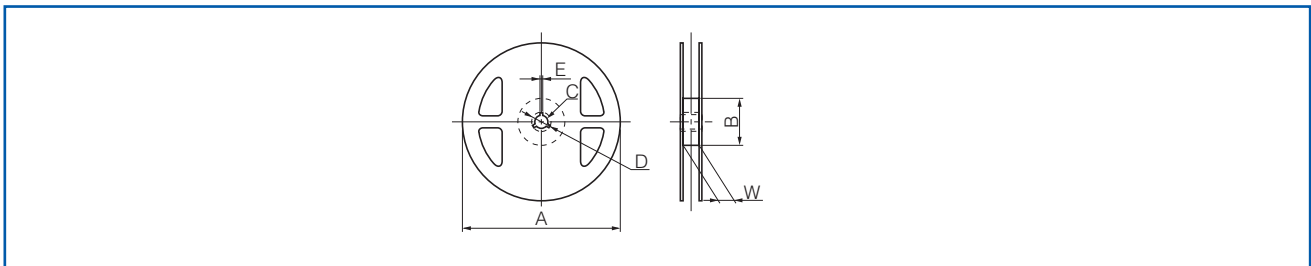

Series	A	B	C	D	E	W
PCC-M0530M-LP PCC-M0630M-LP PCC-M0840M-LP	330	(100)	13	21	2	17.5
PCC-M1040M-LP						25.5

## Component Placement (Taping)

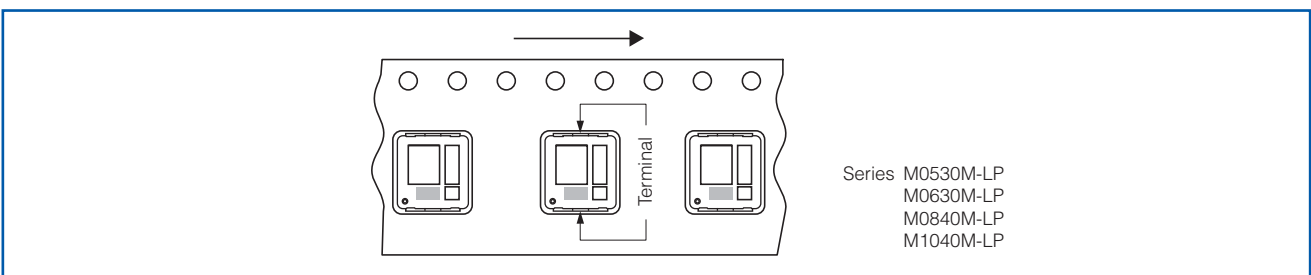

## Standard Packing Quantity/Reel

Series	Part No.	Minimum Quantity / Packing Unit	Quantity per reel
PCC-M0530M-LP	ETQP3M□□□KVP	4,000 pcs. / box (2 reel)	2,000 pcs.
PCC-M0630M-LP	ETQP3M□□□KVN	4,000 pcs. / box (2 reel)	2,000 pcs.
PCC-M0840M-LP	ETQP4M□□□KVK	1,000 pcs. / box (2 reel)	500 pcs.
PCC-M1040M-LP	ETQP4M□□□KVC	1,000 pcs. / box (2 reel)	500 pcs.

## Power Choke Coil for Automotive application

Series : **PCC-D1413H (DUST)**

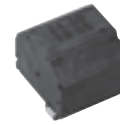

Realize high heat resistance, low loss and high reliability with dust core (DUST)

Industrial Property : patents 5 (Pending)

### Features

- High heat resistance : Operation up to 150 °C
- SMD and small package : L×W×T=14.7×13.2×13.1 mm
- High-reliability : High vibration resistance due to newly developed integral construction and severe reliability condition of automotive application is covered
- High bias current : Excellent inductance stability by using ferrous alloy magnetic material
- High Vibration proof : 5 Hz to 2 kHz/30 G
- High efficiency : Achieve by Low loss Dust core and Edgewise coil with rectangular wire
- AEC-Q200 qualified
- RoHS compliant

### Recommended Applications

- Driver circuits of fuel injection systems in automotive, driver circuits of diesel common rail injection, step-up power supplies for motor driver-circuits

### Standard Packing Quantity

- 600 pcs./10 tray

### Explanation of Part Numbers

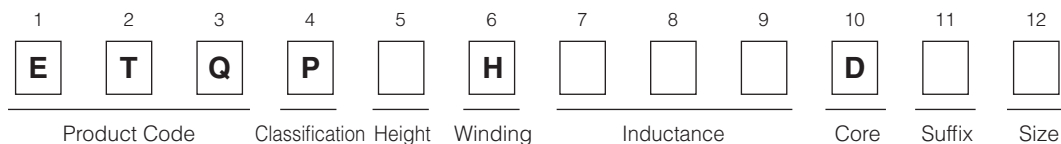

### Temperature rating

Operating temperature range		Tc : -40 °C to +150 °C(Including self-temperature rise)
Storage condition	After PWB mounting	
	Before PWB mounting	Ta : -5 °C to +35 °C 85%RH max.

### Standard Parts

Part No.	Inductance *1		DCR at 20 °C (mΩ)	ACR at 20 kHz (mΩ)	Rated Current *3 ΔT=40K (A)
	L0 at 0A (μH)	L1 at 10A (μH)			
ETQPDH240DTV	36.0±30%	(24.0) *2	25.8 typ.	50.0 typ.	6.9

(\*1) Measured at 100 kHz.

(\*2) Reference Only.

(\*3) DC current which causes temperature rise of 40 K. Parts are soldered by reflow on four-layer PWB (1.6 mm FR4) and measured at room temperature.

\* Within a suitable application, the part's temperature depends on circuit design and certain heat dissipation conditions. This should be double checked in a worst case operation mode.  
In normal case, the max. standard operating temperature of +150 °C should not be exceeded.  
For higher operating temperature conditions, please contact Panasonic representative in your area.



## Performance Characteristics (Reference)

### ● Inductance vs DC Current

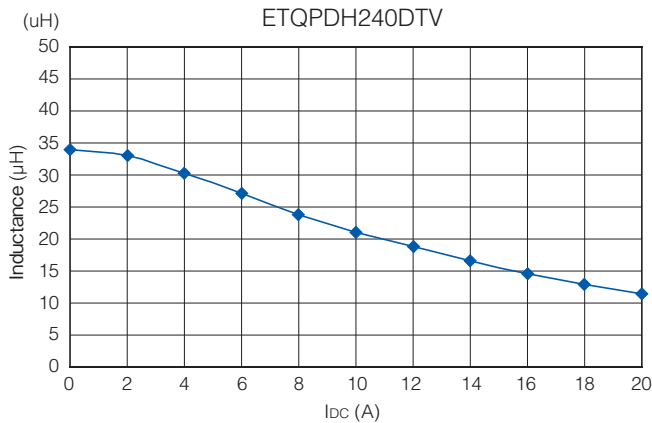

### ● Case Temperature vs DC Current

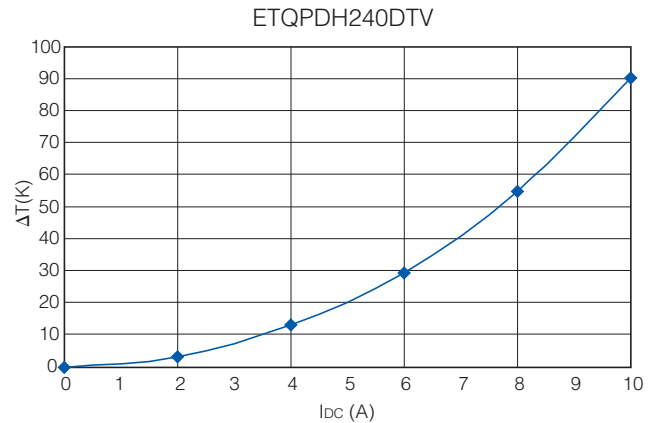

## Dimensions in mm (not to scale)

Dimensional tolerance unless noted : ±0.5

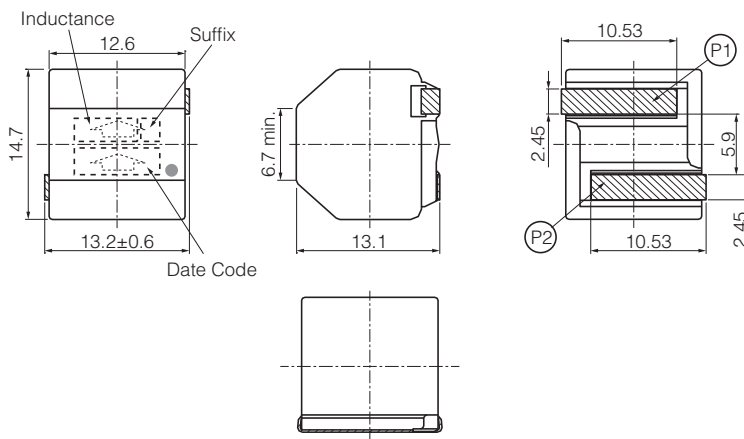

## Connection

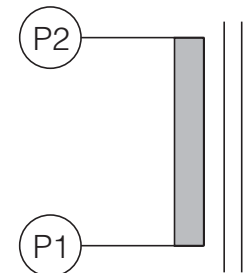

\* None polar character

## Recommended land patterns in mm (not to scale)

Dimensional tolerance unless noted : ±0.5

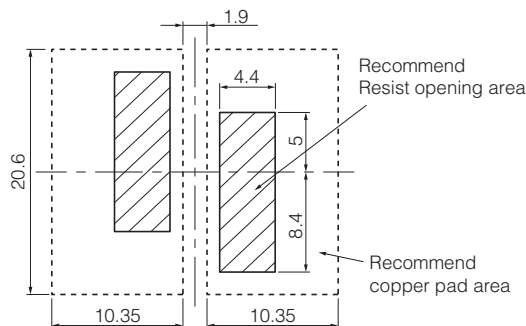

\* Due to bigger part, Thermal Capacity is large and may occur PWB temperature differences during reflow process. Recommended land pattern (Heat absorb) should be designed with reflow mountability.

## ■ As for Soldering Conditions and Safety Precautions (Common precautions for Power Choke Coils for Automotive application),

Please see Data Files

## Packaging Methods (Tray)

- Blister Tray (mm) 60 pcs.

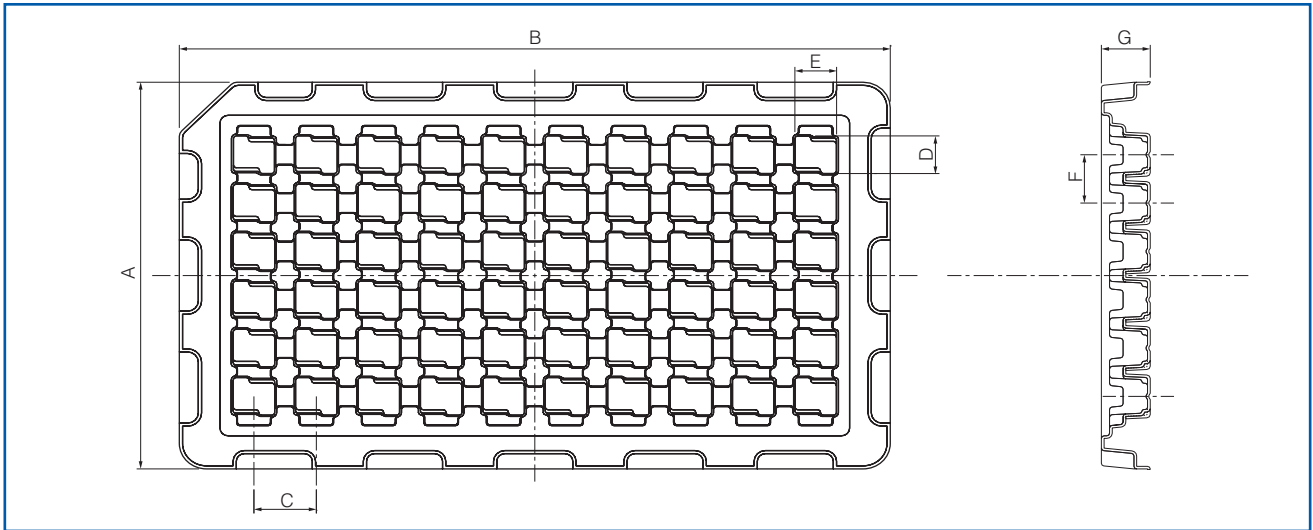

- Blister Tray Dimension

Part No.	A	B	C	D	E	F	G
ETQPDH240DTV	152	262	23	14.8	15.1	19	18

## Component Placement (Tray)

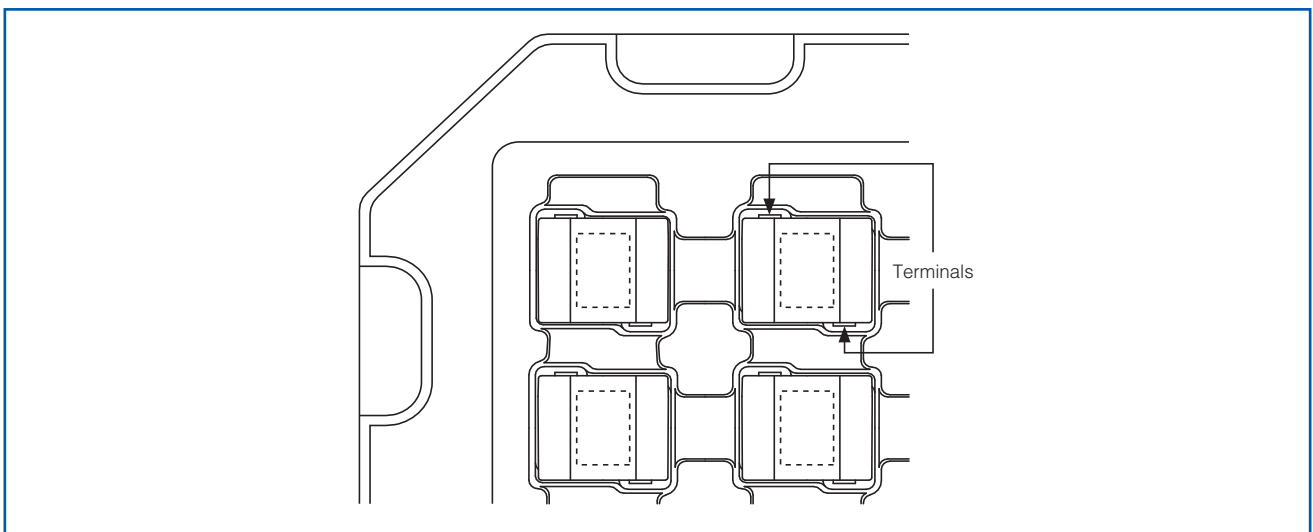

## Standard Packing Quantity/Tray

Part No.	Quantity
ETQPDH240DTV	600 pcs. /10 tray (60 pcs. /1 tray)

## Power Choke Coil

Series : **PCC-M0630L (MC)**  
**PCC-M0630M (MC)**



High power, Low loss, Compact size.  
 Rust proof structure

Industrial Property : patents 21 (Pending)

### Features

- Downsize circuit space due to small and low profile package size
- Excellent DC bias performance and high reliability under high humidity
- Reduce number of components by high power and low loss
- Realize excellent performance by capability to high frequency range
- Low buzz noise
- RoHS compliant

### Recommended Applications

- Servers, Routers, DC/DC converters for driving CPUs
- Laptop and desktop PC power supply
- Power supply modules

### Standard Packing Quantity (Minimum Quantity/Packing Unit)

- 2,000 pcs./box (2 reel)

### Explanation of Part Numbers

- PCC-M0630L series

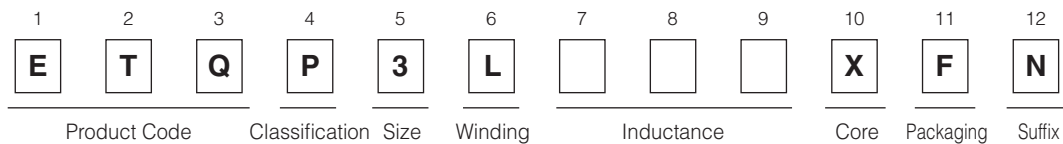

- PCC-M0630M series

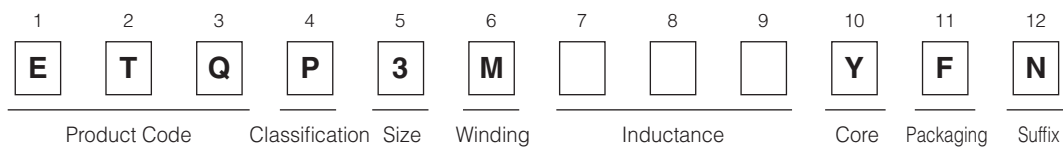

### Standard Parts

Part No.	Inductance *1				Rated current (A) *2	DC resistance		Series
	L0		L1			Center (mΩ)	Tolerance (%)	
	(μH)	Tolerance (%)	(μH)	Measurement current (A)				
ETQP3LR33XFN	0.33	±20	0.28	17	17	2.0	±10	PCC-M0630L
ETQP3M1R5YFN	1.50	±20	1.36	5.6	5.6	11.0	±10	PCC-M0630M

(\*1) Measured at 100 kHz.

(\*2) Rated current defines actual value of DC current, when temperature rise of coil becomes 40 K.

## Performance Characteristics (Reference)

### ● PCC-M0630L (MC)

#### ● Inductance vs DC Current

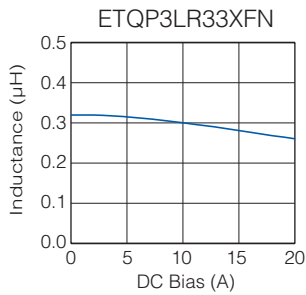

#### ● Case Temperature vs DC Current

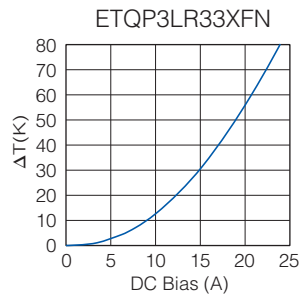

### ● PCC-M0630M (MC)

#### ● Inductance vs DC Current

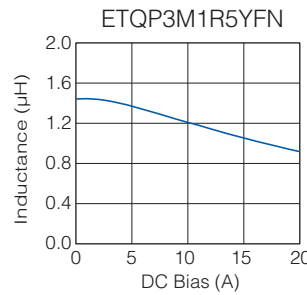

#### ● Case Temperature vs DC Current\*

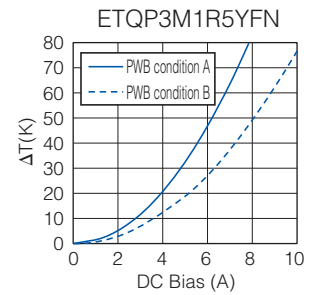

PWB condition A : FR4, single layer PWB, t=1.6mm \*our specification  
PWB condition B : FR4, four layer PWB, t=1.6mm

\* Our temperature rise is specified with measurement of single layer PWB(condition A). Please refer to temperature rise curve V.S. current for the rated current ( $\Delta T=15K$ ) and Reference value ( $\Delta T=40K$ ), and when four layer PWB (condition B) is used, temperature rise is different from single layer PWB (condition A). Even we specify the rated current at our condition, the actual temperature rise of PCC may have different result due to thermal dissipation condition. We recommend customers to measure PCC temperature rise at application to confirm it.

## Dimensions in mm (not to scale)

### PCC-M0630L (MC) (ETQP3LR33XFN)

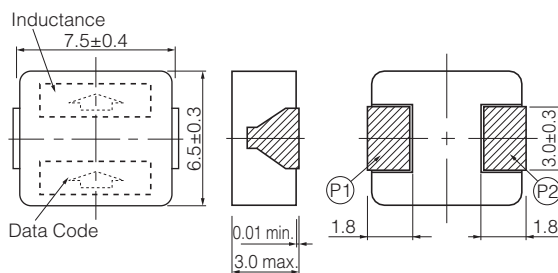

### PCC-M0630M (MC) (ETQP3M1R5YFN)

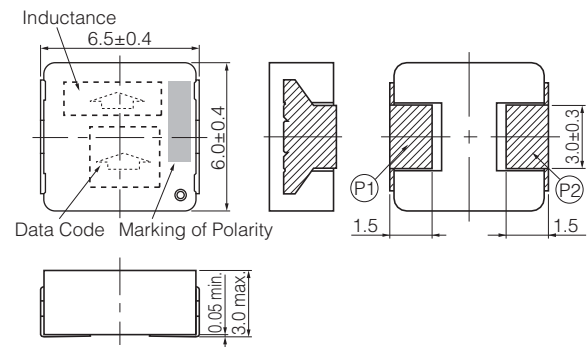

## Connection

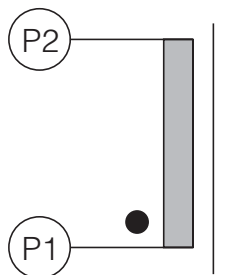

## Recommended land patterns in mm (not to scale)

### PCC-M0630L (MC) (ETQP3LR33XFN)

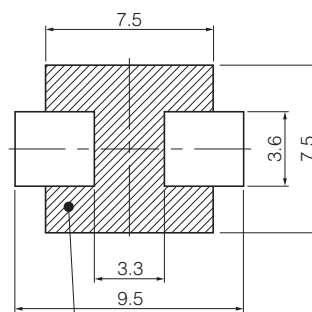

Not to contact the PWB.

### PCC-M0630M (MC) (ETQP3M1R5YFN)

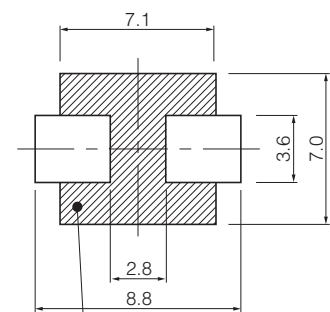

Not to contact the PWB.

## ■ As for Packaging Methods, Soldering Conditions and Safety Precautions (Automotive application : PCC-M0630M, Consumer use : PCC-M0630L)

Please see Data Files

## Power Choke Coil

Series : **PCC-M0512W (MC)**



High power, Low loss, Low-profile

### Features

- Small type (5.4×5.15×H1.2 mm)
- High power (2.2 A to 5.5 A)
- Low loss ( $R_{DC}$  :19.2 to 168.0 mΩ)
- Suitable for high frequency circuit (up to 1 MHz)
- Low buzz noise due to its gap-less structure
- RoHS compliant

### Recommended Applications

- HDD, Tablet PC power supply modules
- Servers, Routers, DC/DC converters for driving CPUs

### Standard Packing Quantity (Minimum Quantity/Packing Unit)

- 6,000 pcs./box (2 reel)

### Explanation of Part Numbers

1	2	3	4	5	6	7	8	9	10	11	12
<b>E</b>	<b>T</b>	<b>Q</b>	<b>P</b>	<b>1</b>	<b>W</b>						
Product Code	Classification			Size	Winding	Inductance		Core	Packaging	Suffix	

### Standard Parts

Part No.	Inductance (at 20 °C)*1			Rated current (A)*2	Rated current (ref) (A)*3	DC resistance (at 20 °C) (mΩ) max.
	L0 at 0A	L1 *4				
	(μH)	(μH)	Measurement current (A)			
ETQP1WR47WFP	0.47±20 %	(0.42)	5.5	5.5	6.7	19.2
ETQP1W1R0WFP	1.00±20 %	(0.87)	4.4	4.4	4.5	46.5
ETQP1W2R2WFP	2.20±20 %	(1.80)	3.4	3.4	3.5	77.3
ETQP1W3R3WFP	3.30±20 %	(2.70)	2.8	2.8	3.0	103.0
ETQP1W4R7WFP	4.70±20 %	(3.90)	2.2	2.2	2.3	168.0

(\*1) Inductance is measured at 100 kHz.

(\*2) Rated current defines actual value of DC current, when temperature rise of coil becomes 40 K. (Method A)

(\*3) Rated current defines actual value of DC current, when temperature rise of coil becomes 40 K. (Method B)

(\*4) Reference only

(\*5) Method A (PANASONIC's standard measurement conditions),

Method B (high heat dissipation measurement) is different from Method A by the measurement methods.

In normal application condition, the part's temperature depends on circuit design and heat dissipation condition.

This condition shall be verified by the worst operational condition.

## Performance Characteristics (Reference)

Inductance vs DC Current

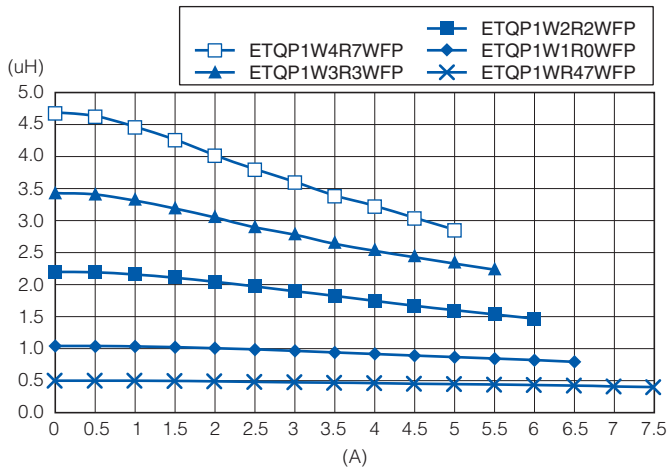

Case Temperature vs DC Current (Method A)

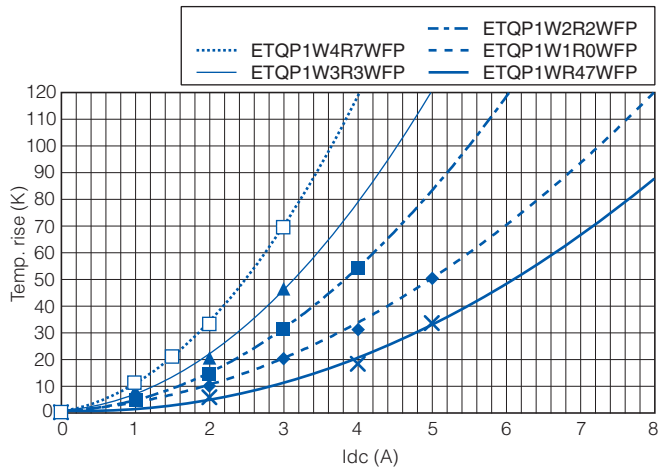

## Dimensions in mm (not to scale)

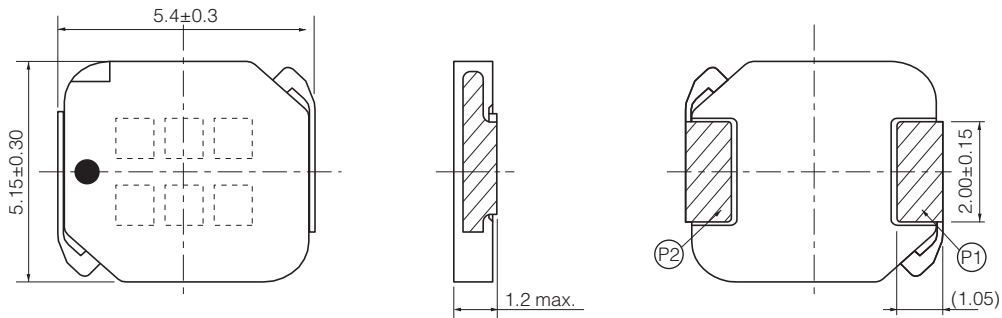

## Connection

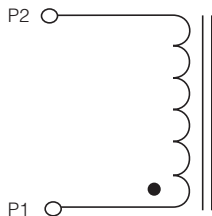

## Recommended land patterns in mm (not to scale)

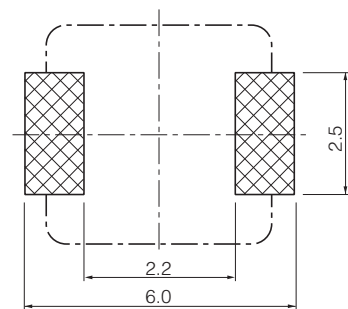

## As for Packaging Methods, Soldering Conditions and Safety Precautions (Power Choke Coils for Consumer use),

Please see Data Files

## Power Choke Coil

Series : **PCC-M0630W (MC)**



High power, Low loss, Low-profile

### Features

- Small type (7.3×6.6×H3.0 mm)
- High power (5.5 A to 20.0 A)
- Low loss ( $R_{DC}$  : 3.3 to 35.0 mΩ)
- Suitable for high frequency circuit (up to 1 MHz)
- Low buzz noise due to its gap-less structure
- RoHS compliant

### Recommended Applications

- Notebook PC power supply modules
- Servers, Routers, DC/DC converters for driving CPUs

### Standard Packing Quantity (Minimum Quantity/Packing Unit)

- 2,000 pcs./box (2 reel)

### Explanation of Part Numbers

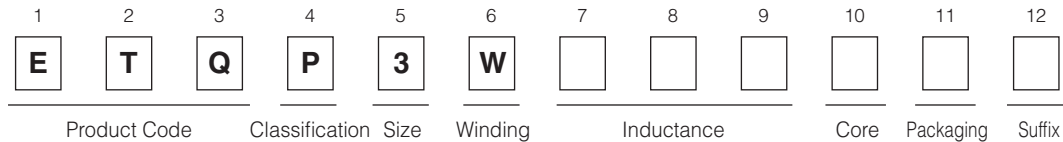

### Standard Parts

Part No.	Inductance (at 20 °C)*1					DC resistance (at 20 °C) (mΩ)	
	L0 at 0A	L1 *4		Rated current (A)*2 (typ.)	Rated current (ref) (A)*3 (typ.)		
	(μH)	(μH)	Measurement current (A)			typ.	max.
ETQP3WR33WFN	0.33±20 %	(0.27)	(20.0)	13.7	21	3.3	3.9
ETQP3WR47WFN	0.47±20 %	(0.38)	(17.0)	11.6	20	3.8	4.2
ETQP3WR68WFN	0.68±20 %	(0.55)	(14.0)	9.6	17	4.9	5.5
ETQP3WR82WFN	0.82±20 %	(0.66)	(13.0)	8.9	14	6.7	8.0
ETQP3W1R0WFN	1.0±20 %	(0.84)	(11.8)	8.1	13	6.9	7.9
ETQP3W1R5WFN	1.5±20 %	(1.24)	(9.6)	6.6	11	9.8	13.0
ETQP3W2R2WFN	2.2±20 %	(1.80)	(8.5)	5.8	9	15.5	17.8
ETQP3W3R3WFN	3.3±20 %	(2.69)	(7.0)	4.8	7.4	25.0	28.8
ETQP3W4R7WFN	4.7±20 %	(3.89)	(5.5)	3.8	5.7	35.0	40.3

(\*1) Inductance is measured at 100 kHz.

(\*2) Rated current defines actual value of DC current, when temperature rise of coil becomes 40 K. (Method A)

(\*3) Rated current defines actual value of DC current, when temperature rise of coil becomes 40 K. (Method B)

(\*4) Reference only

(\*5) Method A (PANASONIC's standard measurement conditions),

Method B (high heat dissipation measurement) is different from Method A by the measurement methods.

In normal application condition, the part's temperature depends on circuit design and heat dissipation condition.

This condition shall be verified by the worst operational condition.

## Performance Characteristics (Reference)

Inductance vs DC Current

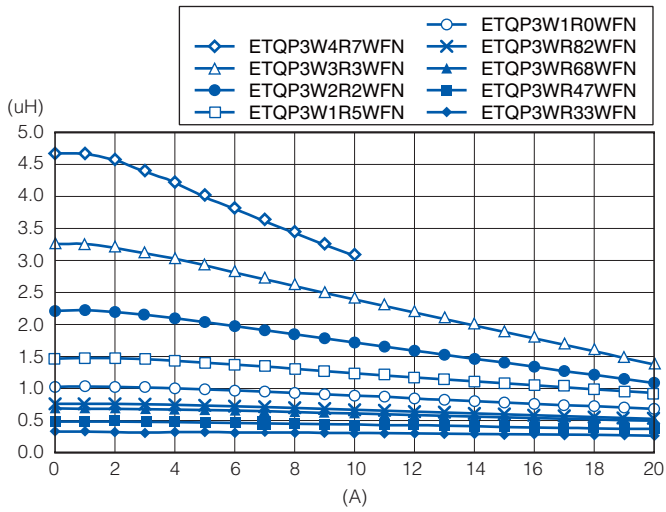

Case Temperature vs DC Current (Method A)

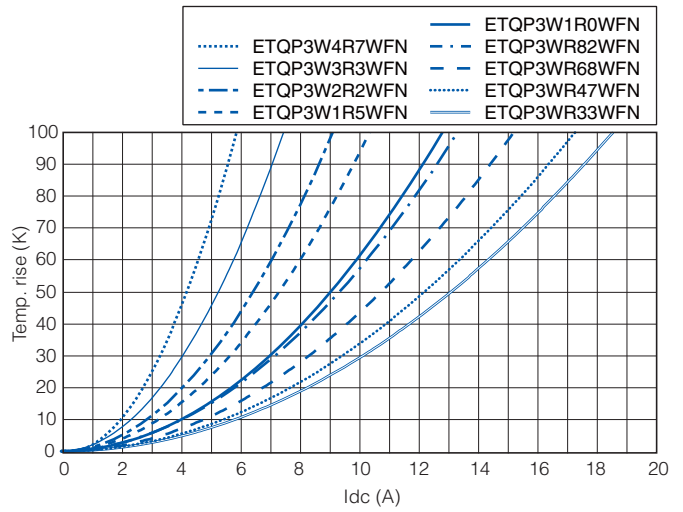

## Dimensions in mm (not to scale)

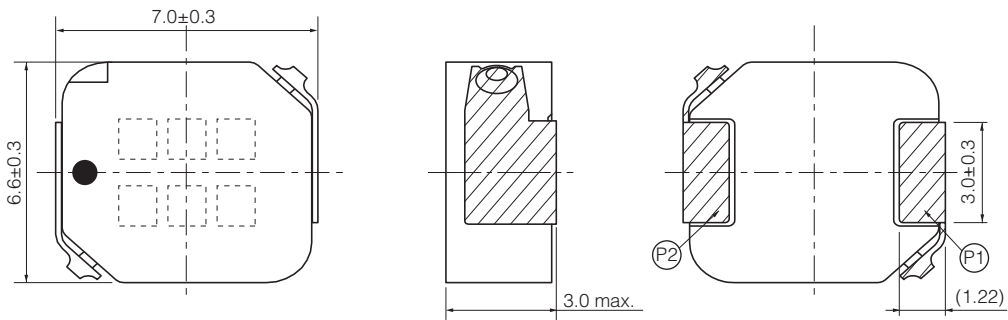

## Connection

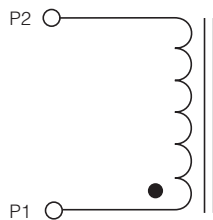

## Recommended land patterns in mm (not to scale)

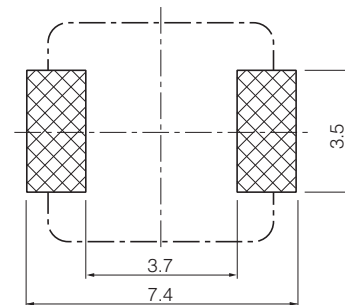

## As for Packaging Methods, Soldering Conditions and Safety Precautions (Power Choke Coils for Consumer use),

Please see Data Files



## Power Choke Coil

Series : **PCC-M0730L (MC)**

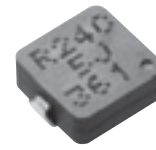

Small mounting size  
for multi-phase DC/DC converter circuits

### Features

- Small type (8.7×7.0×H3.0 mm)
- High power (22 A)
- Low loss ( $R_{DC}$  :1.12 mΩ)
- Tighter DCR tolerance ( $\pm 7$  %)
- Suitable for high frequency circuit (up to 1 MHz)
- Low buzz noise due to its gap-less structure
- RoHS compliant

### Recommended Applications

- Notebook PC power supply modules
- Servers, Routers, DC/DC converters for driving CPUs

### Standard Packing Quantity (Minimum Quantity/Packing Unit)

- 3,000 pcs./box (2 reel)

### Explanation of Part Numbers

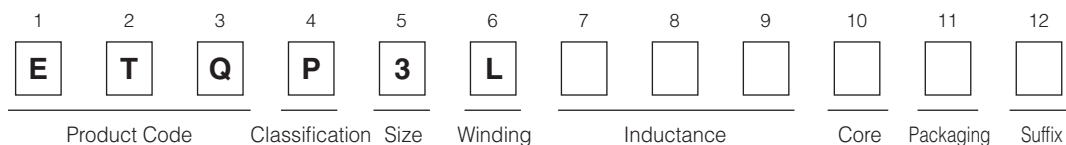

### Standard Parts

Part No.	Inductance (at 20 °C)*1			Rated current (A)*2	Rated current (ref) (A)*3	DC resistance (at 20 °C) (mΩ)
	L0 at 0A	L1 *4				
	(μH)	(μH)	Measurement current (A)			
ETQP3LR24CFM	0.24±20 %	(0.19)	22	22	35	1.12±7 %

(\*1) Inductance is measured at 1.0 MHz.

(\*2) Rated current defines actual value of DC current, when temperature rise of coil becomes 40 K. (Method A)

(\*3) Rated current defines actual value of DC current, when temperature rise of coil becomes 40 K. (Method B)

(\*4) Reference only

(\*5) Method A (PANASONIC's standard measurement conditions),

Method B (high heat dissipation measurement) is different from Method A by the measurement methods.

In normal application condition, the part's temperature depends on circuit design and heat dissipation condition.

This condition shall be verified by the worst operational condition.

## Performance Characteristics (Reference)

Inductance vs DC Current

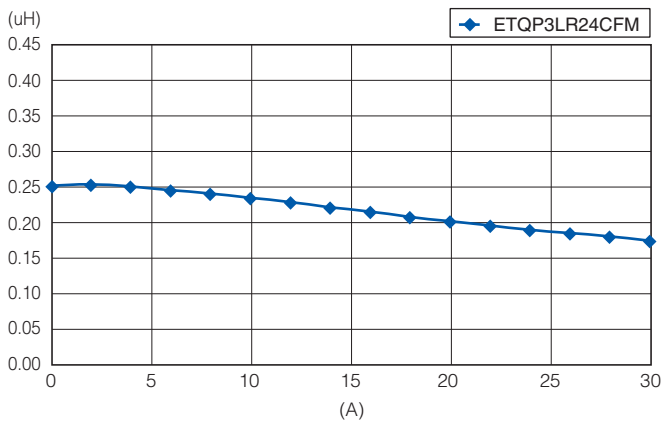

Case Temperature vs DC Current (Method A)

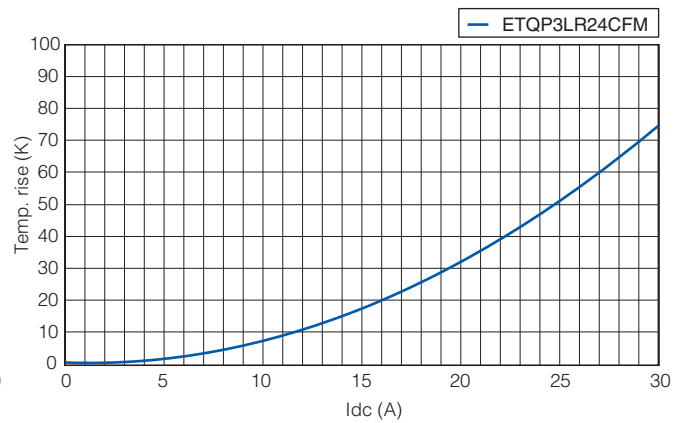

## Dimensions in mm (not to scale)

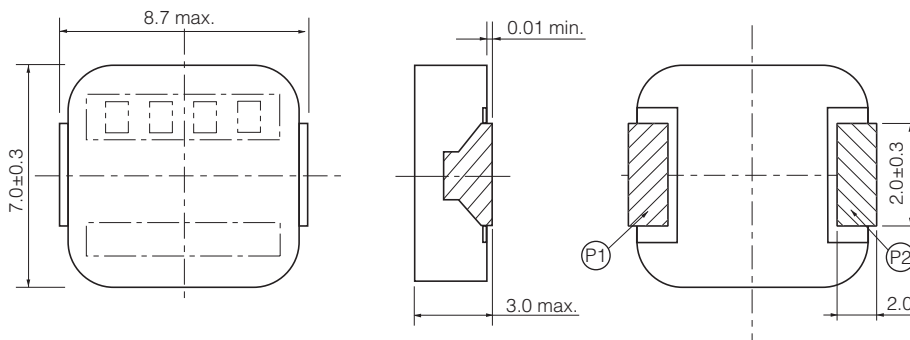

## Connection

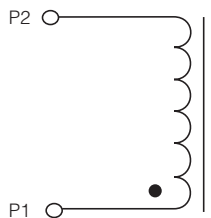

## Recommended land patterns in mm (not to scale)

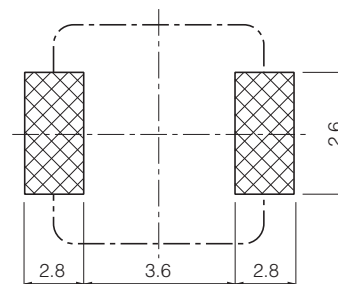

## As for Packaging Methods, Soldering Conditions and Safety Precautions (Power Choke Coils for Consumer use),

Please see Data Files

## Power Choke Coil

### Series : PCC-M0740L (MC) Low DCR Type



Small mounting size  
for multi-phase DC/DC converter circuits

#### Features

- Small type (8.7×7.0×H4.0 mm)
- High power (17 A to 24 A)
- Low loss ( $R_{DC}$  :1.0 to 1.5 mΩ)
- Tighter DCR tolerance ( $\pm 7\%$ )
- Suitable for high frequency circuit (up to 1 MHz)
- Low buzz noise due to its gap-less structure
- RoHS compliant

#### Recommended Applications

- Notebook PC power supply modules
- Servers, Routers, DC/DC converters for driving CPUs

#### Standard Packing Quantity (Minimum Quantity/Packing Unit)

- 3,000 pcs./box (2 reel)

#### Explanation of Part Numbers

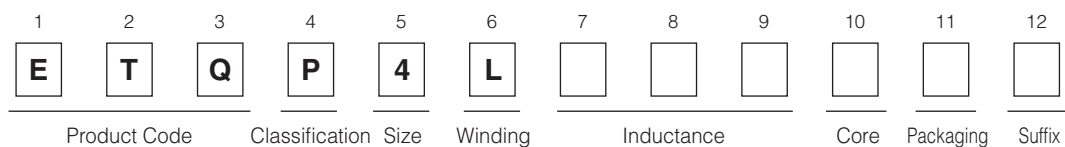

#### Standard Parts

Part No.	Inductance (at 20 °C)*1			Rated current (A)*2	Rated current (ref) (A)*3	DC resistance (at 20 °C) (mΩ)
	L0 at 0A	L1 *4				
	(μH)	(μH)	Measurement current (A)			
ETQP4LR24AFM	0.24±20 %	(0.20)	24	24	35.5	1.00±7 %
ETQP4LR36AFM	0.36±20 %	(0.30)	20	20	31.0	1.35±7 %
ETQP4LR42AFM	0.42±20 %	(0.35)	17	17	28.5	1.50±7 %

(\*1) Inductance is measured at 1.0 MHz.

(\*2) Rated current defines actual value of DC current, when temperature rise of coil becomes 40 K. (Method A)

(\*3) Rated current defines actual value of DC current, when temperature rise of coil becomes 40 K. (Method B)

(\*4) Reference only

(\*5) Method A (PANASONIC's standard measurement conditions),

Method B (high heat dissipation measurement) is different from Method A by the measurement methods.

In normal application condition, the part's temperature depends on circuit design and heat dissipation condition. This condition shall be verified by the worst operational condition.

## Performance Characteristics (Reference)

Inductance vs DC Current

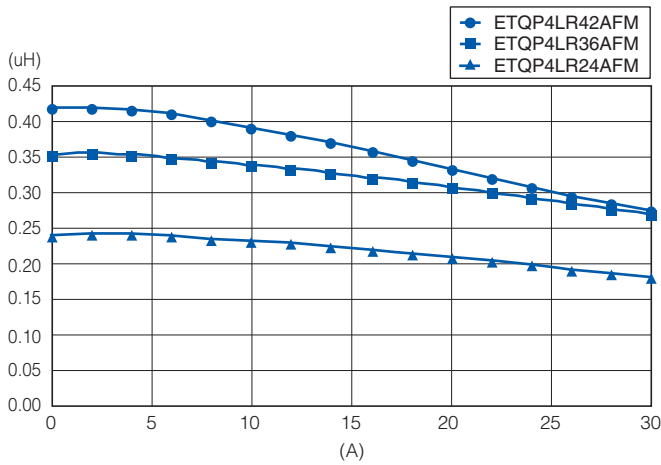

Case Temperature vs DC Current (Method A)

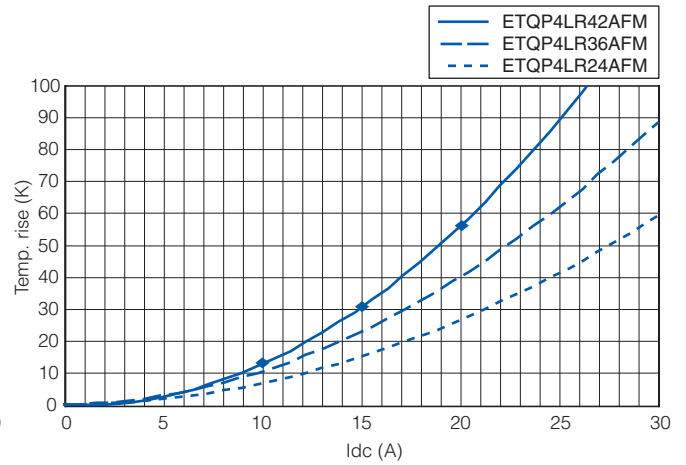

## Dimensions in mm (not to scale)

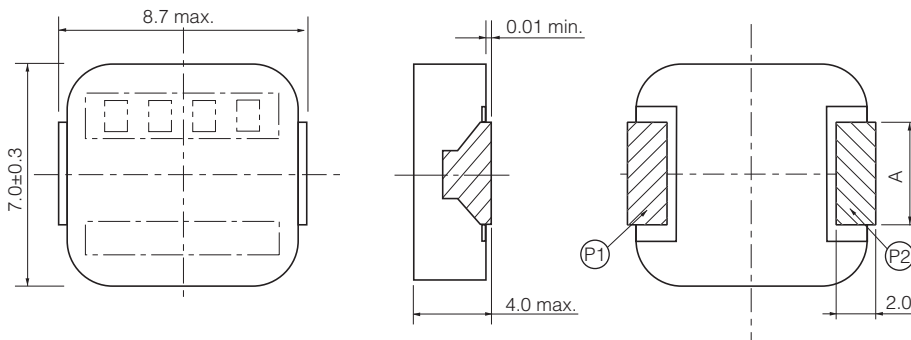

Part No.	A
ETQP4LR24AFM	3.0±0.3
ETQP4LR36AFM	2.0±0.3
ETQP4LR42AFM	

## Connection

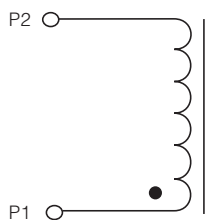

## Recommended land patterns in mm (not to scale)

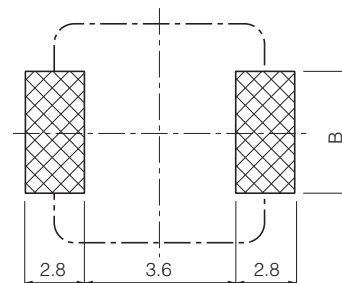

Part No.	B
ETQP4LR24AFM	3.6
ETQP4LR36AFM	2.6
ETQP4LR42AFM	

## As for Packaging Methods, Soldering Conditions and Safety Precautions (Power Choke Coils for Consumer use),

Please see Data Files

## Power Choke Coil

Series : **PCC-M1040L (MC)**



Small mounting size  
for multi-phase DC/DC converter circuits

### Features

- Small type (11.5×10.0×H4.0 mm)
- High power (21 A to 28 A)
- Low loss ( $R_{DC}$  :0.7 to 1.56 mΩ)
- Tighter DCR tolerance ( $\pm 5\%$  to  $\pm 10\%$ )
- Suitable for high frequency circuit (up to 1 MHz)
- Low buzz noise due to its gap-less structure
- RoHS compliant

### Recommended Applications

- Servers, Routers, DC/DC converters for driving CPUs
- Notebook PC power supply modules

### Standard Packing Quantity (Minimum Quantity/Packing Unit)

- 2,000 pcs./box (2 reel) : ETQP4LR36WFC, ETQP4LR56WFC, ETQP4LR45XFC
- 1,000 pcs./box (2 reel) : ETQP4LR19WFC

### Explanation of Part Numbers

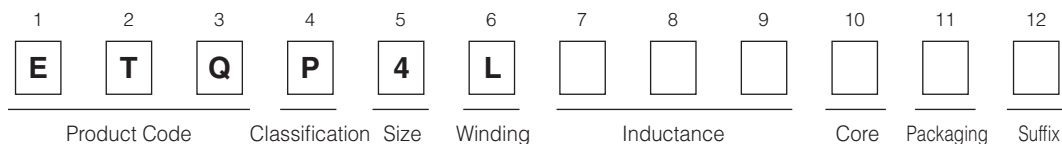

### Standard Parts

Part No.	Inductance (at 20 °C)*1					Rated current (A)*2	Rated current (ref) (A)*3	DC resistance (at 20 °C) (mΩ)
	L0 at 0A	L1		L2 (Reference)*4				
	(μH)	(μH)	Measurement current (A)	(μH)	Measurement current (A)			
ETQP4LR19WFC	(0.20)	0.19±20 %	21	(0.17)	30	28	38	0.70±10 %
ETQP4LR36WFC	(0.37)	0.36±20 %	17	(0.34)	24	24	33	1.10± 5 %
ETQP4LR56WFC	(0.60)	0.56±20 %	15	(0.53)	21	21	28	1.56± 5 %
ETQP4LR45XFC	0.45 <sup>+20%</sup> / <sub>-25%</sub>	—	—	(0.38)	25	25	33	1.10± 5 %

(\*1) Inductance is measured at 100 kHz.

(\*2) Rated current defines actual value of DC current, when temperature rise of coil becomes 40 K. (Method A)

(\*3) Rated current defines actual value of DC current, when temperature rise of coil becomes 40 K. (Method B)

(\*4) Reference only

(\*5) Method A (PANASONIC's standard measurement conditions),

Method B (high heat dissipation measurement) is different from Method A by the measurement methods.

In normal application condition, the part's temperature depends on circuit design and heat dissipation condition.

This condition shall be verified by the worst operational condition.

## Performance Characteristics (Reference)

Inductance vs DC Current

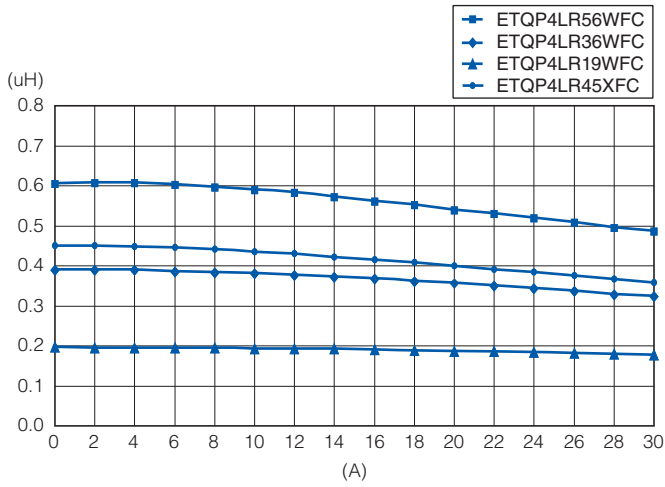

Case Temperature vs DC Current (Method A)

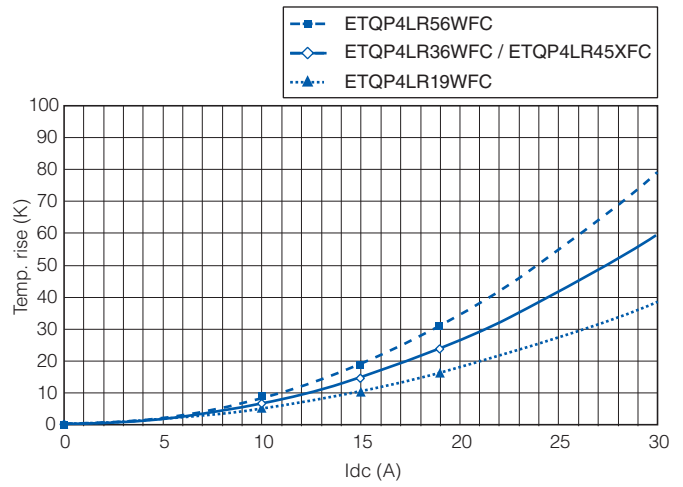

## Dimensions in mm (not to scale)

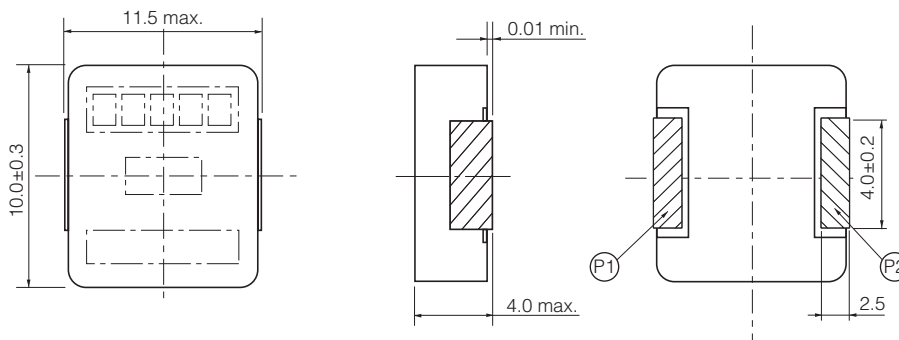

## Connection

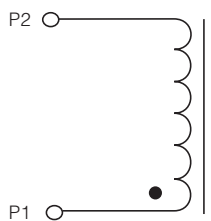

## Recommended land patterns in mm (not to scale)

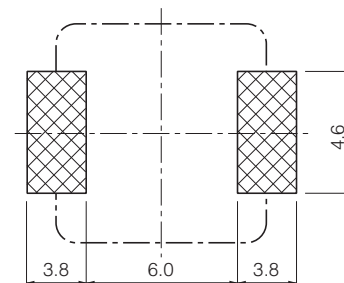

## As for Packaging Methods, Soldering Conditions and Safety Precautions (Power Choke Coils for Consumer use),

Please see Data Files

## Power Choke Coil

Series : **PCC-M1040L (MC)**  
**Low DCR Type**



Small mounting size  
 for multi-phase DC/DC converter circuits

### Features

- Small type (11.7×10.0×H4.0 mm)
- High power (21 A to 30 A)
- Low loss ( $R_{DC}$  :0.76 to 1.58 mΩ)
- Tighter DCR tolerance (±5 %)
- Suitable for high frequency circuit (up to 1 MHz)
- Low buzz noise due to its gap-less structure
- RoHS compliant

### Recommended Applications

- Notebook PC power supply modules
- Servers, Routers, DC/DC converters for driving CPUs

### Standard Packing Quantity (Minimum Quantity/Packing Unit)

- 2,000 pcs./box (2 reel)

### Explanation of Part Numbers

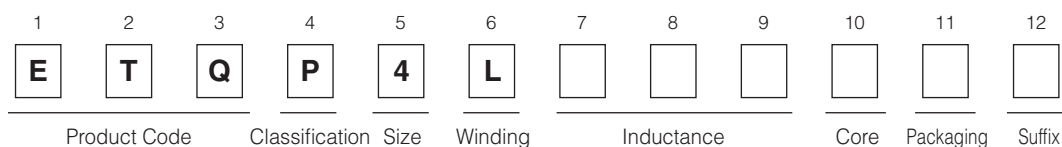

### Standard Parts

Part No.	Inductance (at 20 °C)*1			Rated current (A)*2	Rated current (ref) (A)*3	DC resistance (at 20 °C) (mΩ)
	L0 at 0A	L1 *4				
	(μH)	(μH)	Measurement current (A)			
ETQP4LR36AFC	0.36±20 %	(0.29)	30	30	40	0.76±5 %
ETQP4LR68XFC	0.68±20 %	(0.59)	21	21	28	1.58±5 %

(\*1) Inductance is measured at 1.0 MHz.

(\*2) Rated current defines actual value of DC current, when temperature rise of coil becomes 40 K. (Method A)

(\*3) Rated current defines actual value of DC current, when temperature rise of coil becomes 40 K. (Method B)

(\*4) Reference only

(\*5) Method A (PANASONIC's standard measurement conditions),

Method B (high heat dissipation measurement) is different from Method A by the measurement methods.

In normal application condition, the part's temperature depends on circuit design and heat dissipation condition.

This condition shall be verified by the worst operational condition.

## Performance Characteristics (Reference)

Inductance vs DC Current

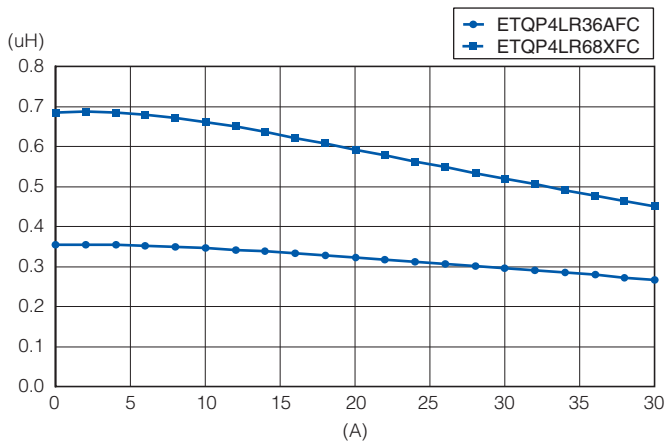

Case Temperature vs DC Current (Method A)

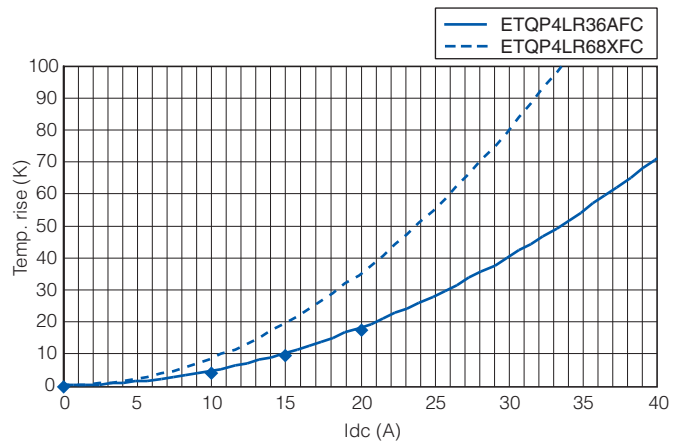

## Dimensions in mm (not to scale)

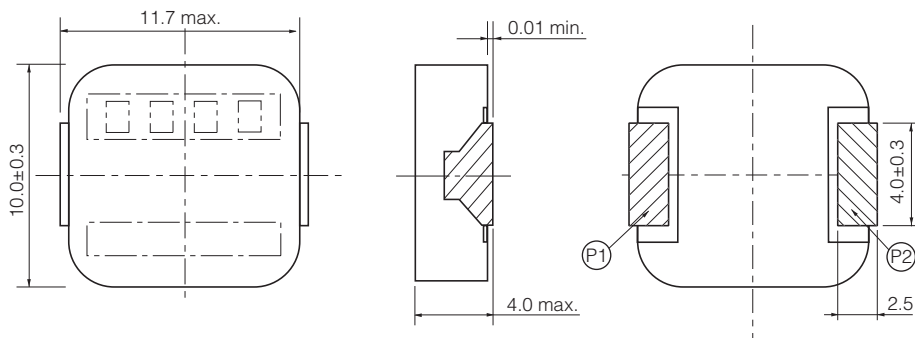

## Connection

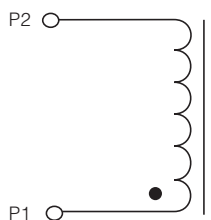

## Recommended land patterns in mm (not to scale)

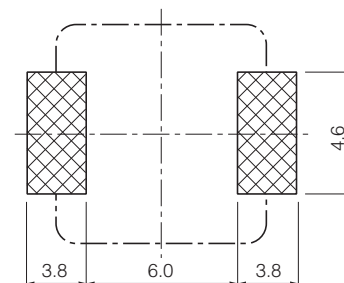

## As for Packaging Methods, Soldering Conditions and Safety Precautions (Power Choke Coils for Consumer use),

Please see Data Files



## Power Choke Coil

Series : **PCC-M1040W (MC)**



High power, Low loss, Low-profile

Industrial Property : patents 10 (Registered 8 / Pending 2)

### Features

- Small type (11.0×10.0×H4.0 mm)
- High power (13 A)
- Low loss ( $R_{DC}$  : 4.0 mΩ)
- Suitable for high frequency circuit (up to 1 MHz)
- Low buzz noise due to its gap-less structure
- RoHS compliant

### Recommended Applications

- Notebook PC power supply modules
- Servers, Routers, DC/DC converters for driving CPUs

### Standard Packing Quantity (Minimum Quantity/Packing Unit)

- 1,000 pcs./box (2 reel)

### Explanation of Part Numbers

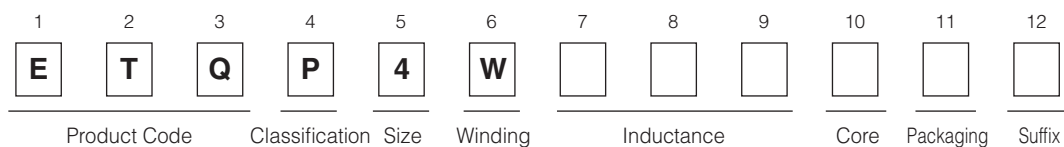

### Standard Parts

Part No.	Inductance (at 20 °C)*1			Rated current (A)*2	DC resistance (at 20 °C) (mΩ) max.
	L0 at 0A	L1*3			
	(μH)	(μH)	Measurement current (A)		
ETQP4W1R5WFC	1.5±20 %	(1.27)	13	13	4.0±15 %

(\*1) Inductance is measured at 100 kHz.

(\*2) Rated current defines actual value of DC current, when temperature rise of coil becomes 40 K. (Method A)

(\*3) Reference only

(\*4) Method A (PANASONIC's standard measurement conditions)

## Performance Characteristics (Reference)

Inductance vs DC Current

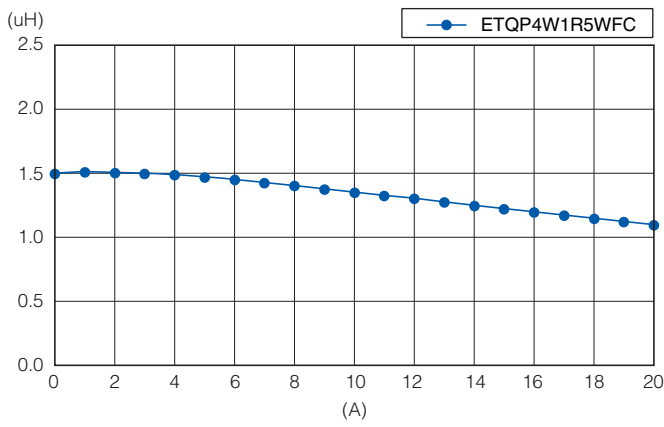

Case Temperature vs DC Current (Method A)

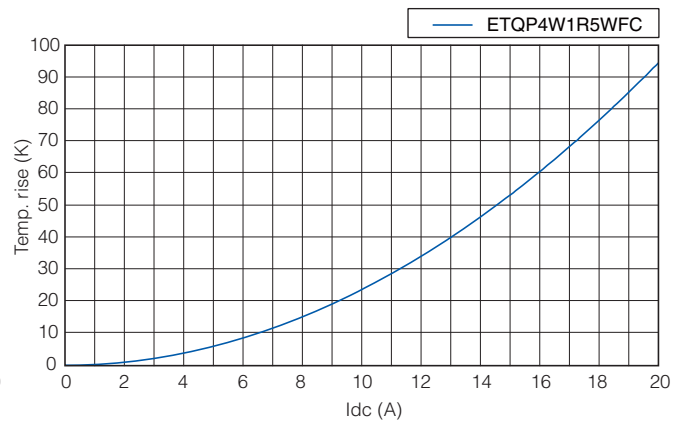

## Dimensions in mm (not to scale)

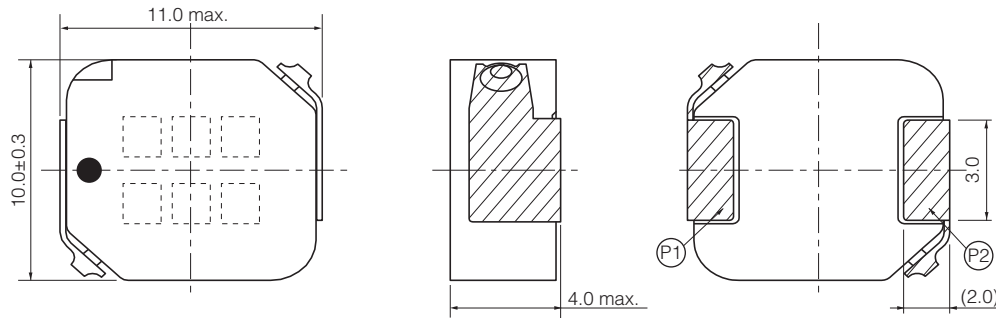

## Connection

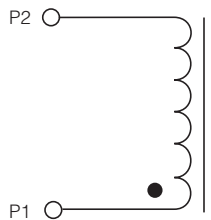

## Recommended land patterns in mm (not to scale)

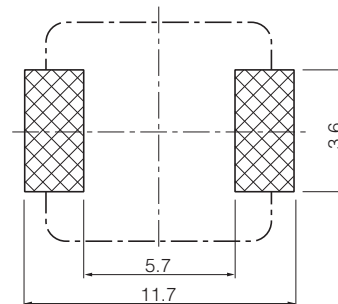

## As for Packaging Methods, Soldering Conditions and Safety Precautions (Power Choke Coils for Consumer use),

Please see Data Files

## Power Choke Coil

Series : **PCC-M1250L (MC)**



High power, Low loss, Low-profile

### Features

- High power (25 A to 30 A)
- Low loss ( $R_{DC}$  :0.8 to 1.1 m $\Omega$ )
- Narrow  $R_{DC}$  tolerance ( $\pm 5$  % to  $\pm 7$  %)
- Low profile (14.5×12.5×H5.0 mm)
- High frequency (up to 1 MHz)
- Low buzz noise due to its gap-less structure
- RoHS compliant

### Recommended Applications

- Servers, Routers, DC/DC converters for driving CPUs
- Notebook PC power supply modules

### Standard Packing Quantity (Minimum Quantity/Packing Unit)

- 1,000 pcs./box (2 reel)

### Explanation of Part Numbers

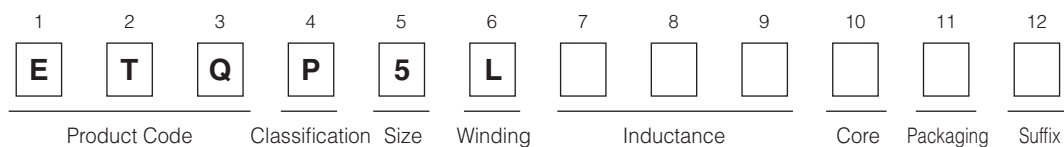

### Standard Parts

Part No.	Inductance (at 20 °C)*1				Rated current (A)*2	DC resistance (at 20 °C) (m $\Omega$ )
	L1		L2 (Reference)			
	( $\mu$ H)	Measurement current (A)	( $\mu$ H)	Measurement current (A)		
ETQP5LR50XFA	0.50 $\pm$ 20 %	30	(0.46)	42	30	0.80 $\pm$ 7 %
ETQP5LR60XFA	0.60 $\pm$ 20 %	30	(0.54)	42	27	1.10 $\pm$ 5 %

(\*1) Inductance is measured at 100 kHz.

(\*2) Rated current defines actual value of DC current, when temperature rise of coil becomes 40 K.

## Performance Characteristics (Reference)

Inductance vs DC Current

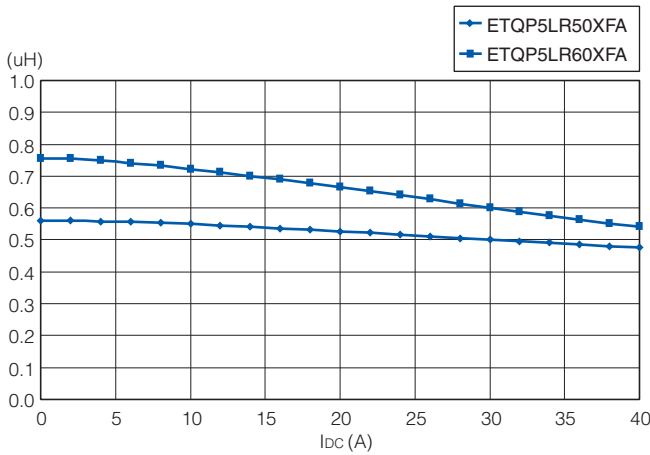

Case Temperature vs DC Current

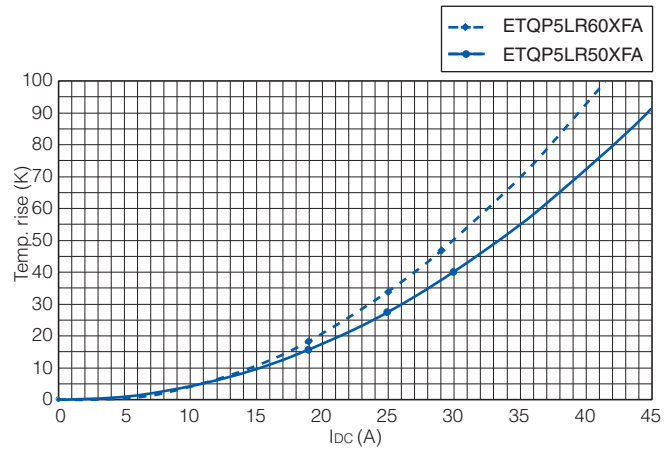

## Dimensions in mm (not to scale)

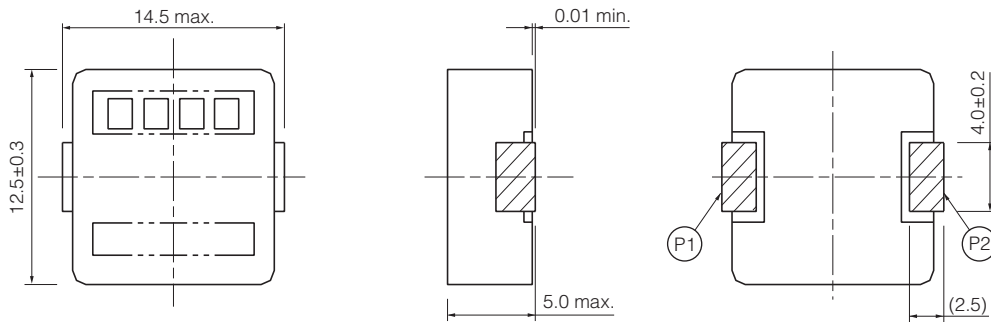

## Connection

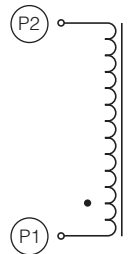

## Recommended land patterns in mm (not to scale)

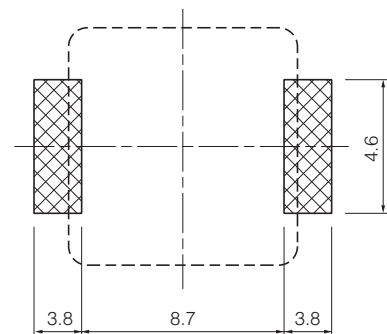

■ **As for Packaging Methods, Soldering Conditions and Safety Precautions (Power Choke Coils for Consumer use),**  
Please see Data Files

## Packaging Methods (Taping)

- Embossed Carrier Tape Dimensions in mm (not to scale)

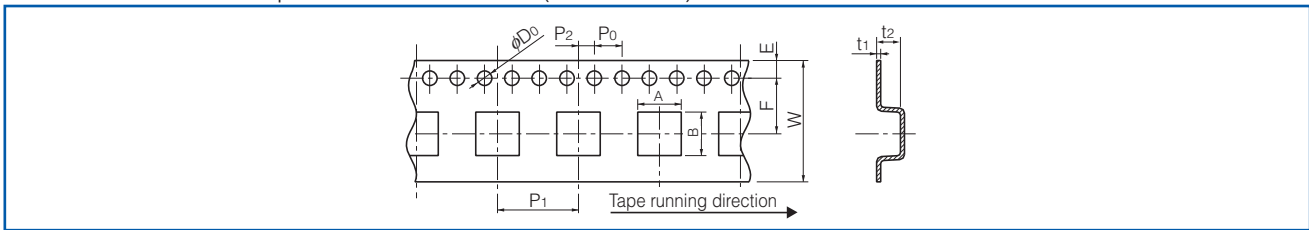

### Power Choke Coils for Automotive application

Series	A	B	W	E	F	P <sub>1</sub>	P <sub>2</sub>	P <sub>0</sub>	φD <sub>0</sub>	t <sub>1</sub>	t <sub>2</sub>		
PCC-M0530M	5.6	6.1	16.0	1.75	7.5	12.0	2.0	4.0	1.5	0.4	3.3		
PCC-M0540M											4.3		
PCC-M0630M											3.3		
PCC-M0645M	5.0												
PCC-M0754M/M0750M	8.1	7.6			24.0	11.5					16.0	0.5	6.3
PCC-M0854M/M0850M	9.1	8.6											
PCC-M1054M/M1050M	10.7	11.9											
PCC-M1050ML/M1060ML													

### Power Choke Coils for consumer use

Series	A	B	W	E	F	P <sub>1</sub>	P <sub>2</sub>	P <sub>0</sub>	φD <sub>0</sub>	t <sub>1</sub>	t <sub>2</sub>	
PCC-M0512W	5.6	5.85	12.0	1.75	5.5	8.0	2.0	4.0	1.5	0.4	1.4	
PCC-M0630L	7.1	8.0			7.5						12.0	3.2
PCC-M0630W	7.2	7.5										3.3
PCC-M0730L	7.6	8.9	24.0		11.5	16.0					5.2	
PCC-M0740L	7.6	8.9										4.2
PCC-M1040W	10.6	11.0									4.3	
PCC-M1040L	10.6	11.8				5.2						
PCC-M1250L	13.1	14.8				5.3						
PCC-D124H	13.5	13.5	24.0	11.5	16.0	5.2						
PCC-D125H							6.2					
PCC-D126H							6.0					
PCC-D126F	13.0	13.0	24.0	11.5	16.0	5.2						
PCC-F126F							6.0					

- Taping Reel Dimensions in mm (not to scale)

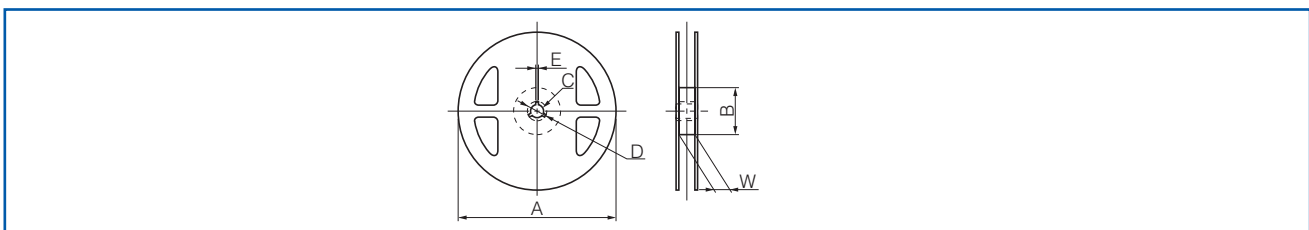

### Power Choke Coils for Automotive application

Series	A	B	C	D	E	W
PCC-M0530M/M0540M	330	100	13	21	2	17.5
PCC-M0630M/M0645M						25.5
PCC-M0754M/M0750M						
PCC-M0854M/M0850M						
PCC-M1054M/M1050M	380	80	13	21	2	25.4
PCC-M1050ML/M1060ML						

### Power Choke Coils for consumer use

Series	A	B	C	D	E	W
PCC-M0512W	330	(80)	13	21	2	13.5
PCC-M0630L/M0630W						17.5
PCC-M1040W						25.5
PCC-M0730L/M0740L	380	80	13	21	2	17.5
PCC-M1040L						25.4
PCC-M1250L/D124H/D125H/ D126H/D126F/F126F						25.4

Design and specifications are each subject to change without notice. Ask factory for the current technical specifications before purchase and/or use.  
Should a safety concern arise regarding this product, please be sure to contact us immediately.

## Component Placement (Taping)

### ● Power Choke Coils for Automotive application

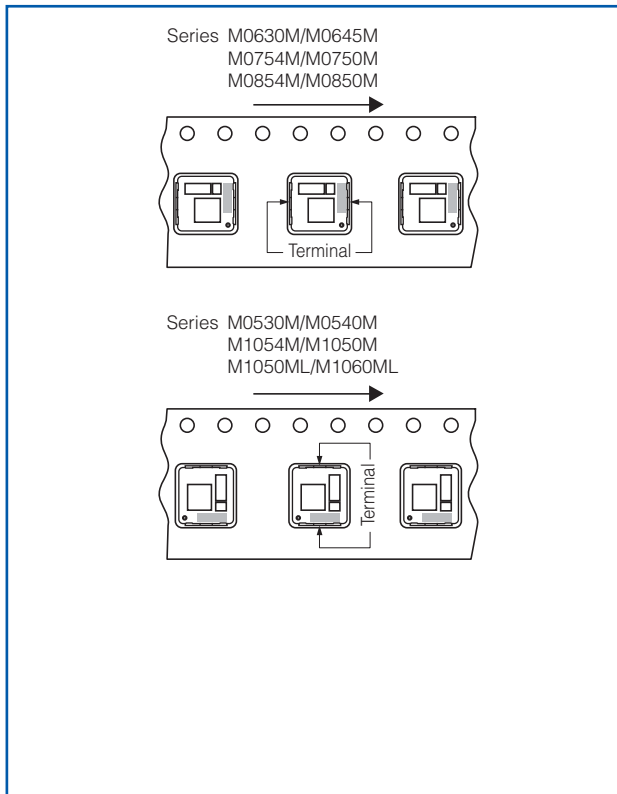

### ● Power Choke Coils for consumer use

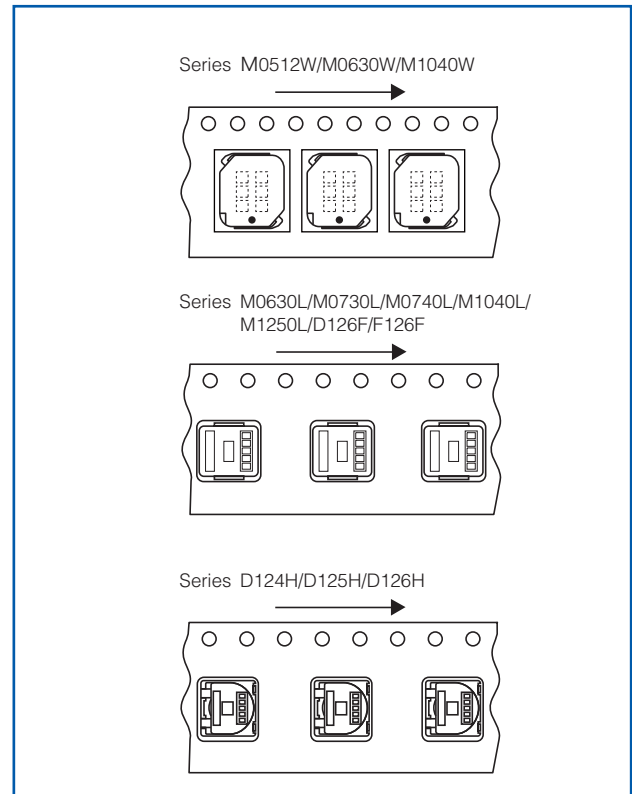

## Standard Packing Quantity/Reel

### ● Power Choke Coils for Automotive application

Series	Minimum Quantity / Packing Unit	Quantity per reel
PCC-M0530M/M0540M	2,000 pcs. / box (2 reel)	1,000 pcs.
PCC-M0630M		
PCC-M0645M	1,000 pcs. / box (2 reel)	500 pcs.
PCC-M0754M/M0750M		
PCC-M0854M/M0850M		
PCC-M1054M/M1050M		
PCC-M1050ML/M1060ML		

### ● Power Choke Coils for consumer use

Series	Minimum Quantity / Packing Unit	Quantity per reel
PCC-M0512W	6,000 pcs. / box (2 reel)	3,000 pcs.
PCC-M0730L	3,000 pcs. / box (2 reel)	1,500 pcs.
PCC-M0740L		
PCC-M0630L	2,000 pcs. / box (2 reel)	1,000 pcs.
PCC-M0630W		
PCC-M1040L		
PCC-M1040L (ETQP4LR19WFC)	1,000 pcs. / box (2 reel)	500 pcs.
PCC-M1040W		
PCC-M1250L		
PCC-D124H		
PCC-D125H		
PCC-D126H		
PCC-D126F		
PCC-F126F		

## Soldering Conditions

### Reflow soldering conditions

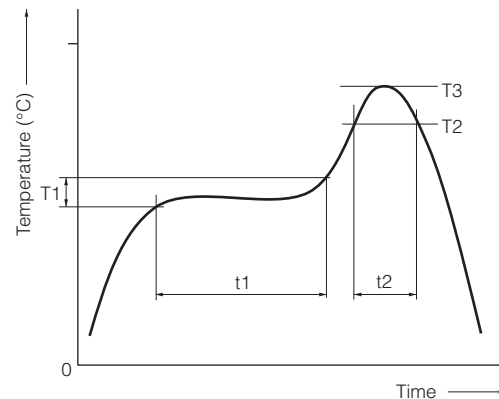

- Pb free solder recommended temperature profile  
Power Choke Coils for Automotive application

Series	Preheat		Soldering		Peak Temperature		Time of Reflow
	T1 [°C]	t1 [s]	T2 [°C]	t2 [s]	T3	T3 Limit	
PCC-M0530M/M0540M PCC-M0630M/M0645M PCC-M0754M/M0750M PCC-M0854M/M0850M PCC-M1054M/M1050M PCC-M1050ML/M1060ML PCC-M1280MF PCC-M0530M-LP PCC-M0630M-LP PCC-M0840M-LP PCC-M1040M-LP PCC-D1413H	150 to 170	60 to 120	230 °C	30 to 40	250 °C, 5 s	260 °C, 10 s	2 times max.

### Power Choke Coils for consumer use

Series	Preheat		Soldering		Peak Temperature		Time of Reflow
	T1 [°C]	t1 [s]	T2 [°C]	t2 [s]	T3	T3 Limit	
PCC-M0512W PCC-M0630L PCC-M0630W PCC-M0730L PCC-M0740L PCC-M1040L PCC-M1040W PCC-M1250L PCC-D124H PCC-D125H PCC-D126H PCC-D126F PCC-F126F	150 to 170	60 to 120	230 °C	30 to 40	250 °C, 5 s	260 °C, 10 s	2 times max.

## ⚠ Safety Precautions

(Common precautions for Power Choke Coils for Automotive application : Series DUST, Series MC)

- When using our products, no matter what sort of equipment they might be used for, be sure to make a written agreement on the specifications with us in advance. The design and specifications in this catalog are subject to change without prior notice.
- Do not use the products beyond the specifications described in this catalog.
- This catalog explains the quality and performance of the products as individual components. Before use, check and evaluate their operations when installed in your products.
- Install the following systems for a failsafe design to ensure safety if these products are to be used in equipment where a defect in these products may cause the loss of human life or other significant damage, such as damage to vehicles (automobile, train, vessel), traffic lights, medical equipment, aerospace equipment, electric heating appliances, combustion/gas equipment, rotating equipment, and disaster/crime prevention equipment.
- \* Systems equipped with a protection circuit and a protection device
- \* Systems equipped with a redundant circuit or other system to prevent an unsafe status in the event of a single fault

## ⚠ Precautions for use

### 1. Provision to abnormal condition

This power choke coil itself does not have any protective function in abnormal condition such as overload, short-circuit and open-circuit conditions, etc.

Therefore, it shall be confirmed as the end product that there is no risk of smoking, fire, dielectric withstand voltage, insulation resistance, etc. in abnormal conditions to provide protective devices and/or protection circuit in the end product.

### 2. Temperature rise

Temperature rise of power choke coil depends on the installation condition in end products. It shall be confirmed in the actual end product that temperature rise of power choke coil is in the limit of specified temperature class.

### 3. Dielectric strength

Dielectric withstanding test with higher voltage than specific value will damage Insulating material and shorten its life.

### 4. Water

This Power choke coil must not be used in wet condition by water, coffee or any liquid because insulation strength becomes very low in such condition.

### 5. Potting

If this power choke coil is potted in some compound, coating material of magnet wire might be occasionally damaged. Please ask us if you intend to pot this power choke coil.

### 6. Model

When this power choke coil is used in a similar or new product to the original one, it might be unable to satisfy the specifications due to difference of condition of usage.

Please ask us if you use this power choke coil in the manner such as above.

### 7. Drop

If the power choke coil receives mechanical stress such as drop, characteristics may become poor (due to damage on coil bobbin, etc.). Never use such stressed power choke coil.

### 8. Printed circuit board design

- ① Land pattern and Via which exceed Operating Voltage, should not be placed top layer PWB under the products for keeping isolation between inside coil and surface of PWB. **(Series DUST)**
- ② To the opposing part in this power choke coil bottom please install neither pattern nor the beer, etc. **(Series MC)**

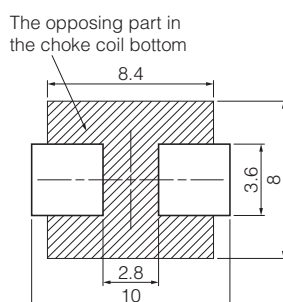



- ③ Parts arranged around this power choke coil do not touch the surface of this power choke coil (Top side and side).  
(Series MC)

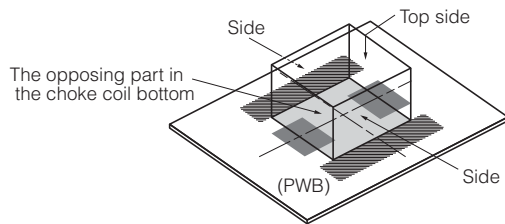

- ④ This power choke coil is different from the ferrite core-type that installs general concentration GAP. It has the leakage magnetic bunch distribution of the choke coil to the vertical direction. Please be cautious when using parts and circuit compositions which are easily affected by the leakage flux.

## 9. Solvent (Series MC)

If this power choke coil is dipped in the cleaning agent, and the coating agent of the toluene and the xylene system, there is a possibility that the performance decreases greatly. Please ask us if you intend to pot this power choke coil.

## 10. Static electricity measures (Series MC)

### ① Circuit design

Please set up the ESD measures parts such as capacitors in the former steps of this power choke coil for static electricity when there is a possibility that static electricity is impressed to the choke coil on the circuit.

Moreover, please consult our company about such a case once.

### ② Treatment with single

Take countermeasures against static electricity when using single power choke coil. (process and equipment)

There is a possibility that the characteristic changes when the voltage of 200 V or more is impressed to this power choke coil. Please handle 200 V or less.

## 11. Other using environment

This power choke coil is not designed for the use in the following, special environment.

Therefore, please do not use it in the following special environment.

- Use in place where a lot of causticity gases such as sea breeze, Cl<sub>2</sub>, H<sub>2</sub>S, NH<sub>3</sub>, SO<sub>2</sub>, and No<sub>x</sub> exist.
- Use in place where out-of-door exposure and direct sunshine strike.

## 12. Keeping environment

If this power choke coil is kept under following environment and condition, there is a possibility that the performance and soldering decreases greatly.

- Keep in place where a lot of causticity gases such as sea breeze, Cl<sub>2</sub>, H<sub>2</sub>S, NH<sub>3</sub>, SO<sub>2</sub>, and No<sub>x</sub> exist.
- Keep in place where out-of-door exposure and direct sunshine strike.

### <Package markings>

Package markings include the product number, quantity, and country of origin.

In principle, the country of origin should be indicated in English.

## ⚠ Safety Precautions

(Common precautions for Power Choke Coils for consumer use)

- When using our products, no matter what sort of equipment they might be used for, be sure to make a written agreement on the specifications with us in advance. The design and specifications in this catalog are subject to change without prior notice.
- Do not use the products beyond the specifications described in this catalog.
- This catalog explains the quality and performance of the products as individual components. Before use, check and evaluate their operations when installed in your products.
- Install the following systems for a failsafe design to ensure safety if these products are to be used in equipment where a defect in these products may cause the loss of human life or other significant damage, such as damage to vehicles (automobile, train, vessel), traffic lights, medical equipment, aerospace equipment, electric heating appliances, combustion/gas equipment, rotating equipment, and disaster/crime prevention equipment.
- \* Systems equipped with a protection circuit and a protection device
- \* Systems equipped with a redundant circuit or other system to prevent an unsafe status in the event of a single fault

## ⚠ Precautions for use

### 1. Provision to abnormal condition

This power choke coil itself does not have any protective function in abnormal condition such as overload, short-circuit and open-circuit conditions, etc.

Therefore, it shall be confirmed as the end product that there is no risk of smoking, fire, dielectric withstand voltage, insulation resistance, etc. in abnormal conditions to provide protective devices and/or protection circuit in the end product.

### 2. Temperature rise

Temperature rise of power choke coil depends on the installation condition in end products. It shall be confirmed in the actual end product that temperature rise of power choke coil is in the limit of specified temperature class.

### 3. Dielectric strength

Dielectric withstanding test with higher voltage than specific value will damage Insulating material and shorten its life.

### 4. Water

This Power choke coil must not be used in wet condition by water, coffee or any liquid because insulation strength becomes very low in such condition.

### 5. Potting

If this power choke coil is potted in some compound, coating material of magnet wire might be occasionally damaged. Please ask us if you intend to pot this power choke coil.

### 6. Detergent

Please consult our company when using detergent for the power choke coil as reliability confirmation etc., is necessary.

### 7. Storage temperature

-5 °C to +35 °C

### 8. Operating temperature

Minimum temperature : -40 °C (Ambient temperature of the power choke coil)

Maximum temperature : 130 °C (Ambient temperature of the power choke coil plus the temperature rise)

100 °C (Only series : PCC-F126F(N6))

### 9. Model

When this power choke coil is used in a similar or new product to the original one, it might be unable to satisfy the specifications due to difference of condition of usage.

Please ask us if you use this power choke coil in the manner such as above.

### 10. Drop

If the power choke coil receives mechanical stress such as drop, characteristics may become poor (due to damage on coil bobbin, etc.). Never use such stressed power choke coil.

### <Package markings>

Package markings include the product number, quantity, and country of origin.

In principle, the country of origin should be indicated in English.

## Power Inductors (Multilayer type, Wire Wound type) · Selection Guide

No.	Dimensions (mm)		Type	Appearance Magnetic shielded structure	Inductance [L] ( $\mu\text{H}$ )					Rated Current $I_{\text{dc}}$ (A)			
	External dimension (typ.)	Height (max.)			1.0	10	100	1000	10000				
1	2.0 × 1.25	1.0	ELGTEA		0.47 $\mu\text{H}$		4.7 $\mu\text{H}$			0.8 to 1.2			
2	2.0 × 1.6	1.0	ELGUEB		0.24 $\mu\text{H}$		2.2 $\mu\text{H}$			0.7 to 3.7			
3	3.0	1.0	ELLVEG		0.68 $\mu\text{H}$		22 $\mu\text{H}$			0.33 to 1.80			
4		1.2	ELLVFG-C					33 $\mu\text{H}$			0.28 to 1.50		
5		1.5	ELLVGG						47 $\mu\text{H}$			0.27 to 1.80	
6		1.5	ELLVGG-C							100 $\mu\text{H}$		0.18 to 1.40	
7	3.8	1.2	ELL4FG-A					47 $\mu\text{H}$			0.29 to 1.90		
8		1.4	ELL4GG		1.2 $\mu\text{H}$				100 $\mu\text{H}$			0.25 to 1.90	
9		1.8	ELL4LG-A							150 $\mu\text{H}$			0.22 to 1.90
10	6.0	1.6	ELL6GG					100 $\mu\text{H}$			0.30 to 2.50		
11		2.0	ELL6PG		0.8 $\mu\text{H}$					100 $\mu\text{H}$			0.38 to 2.80
12	6.0 × 6.4	2.8	ELL6RH					220 $\mu\text{H}$			0.20 to 3.00		
13		3.3	ELL6SH						680 $\mu\text{H}$			0.16 to 3.40	
14		5.0	ELL6UH				10 $\mu\text{H}$			1000 $\mu\text{H}$			0.18 to 1.80
15	8.0	5.0	ELL8TP		0.8 $\mu\text{H}$				1000 $\mu\text{H}$			0.25 to 9.00	
16	10.0	4.5	ELLATP							1000 $\mu\text{H}$			0.31 to 8.00
17	12.0	4.5	ELLCTP			1.2 $\mu\text{H}$				1000 $\mu\text{H}$			0.40 to 7.00

\* Please see the pages of each product for details of the electrical characteristics.

## Multilayer Power Inductors

Type: **ELGUEB**

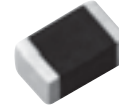

### Features

- Realized the high current by the original laminating process technology
- Magnetic shielded structure
- Small and thin structure (2.0×1.6×1.0mm max.)
- RoHS compliant

### Recommended Applications

- DC/DC converter circuit use of the small portable device  
Smart phone, mobile phone, DSC .

### Standard Packing Quantity

- 4000 pcs./Reel

### Explanation of Part Numbers

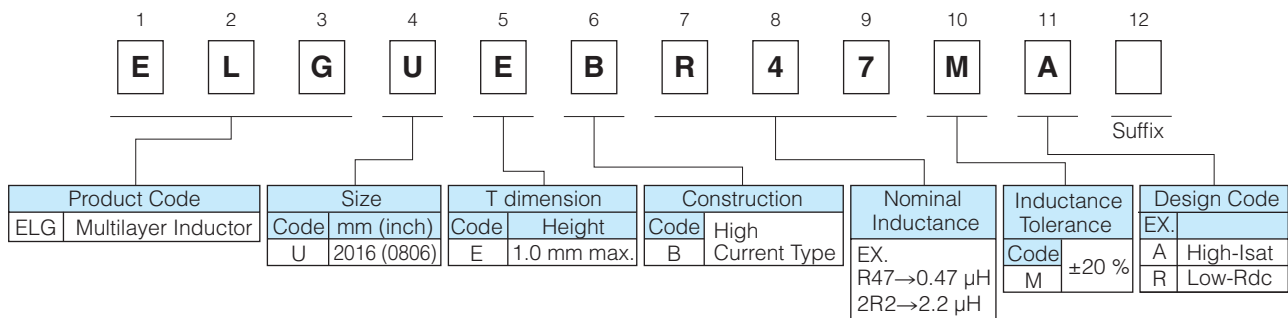

### Dimensions in mm (not to scale)

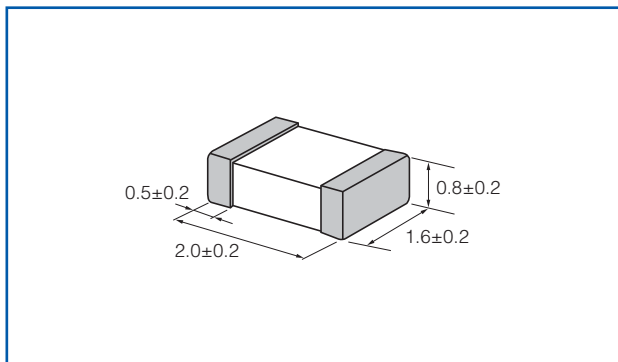

### Recommended Land Pattern in mm (not to scale)

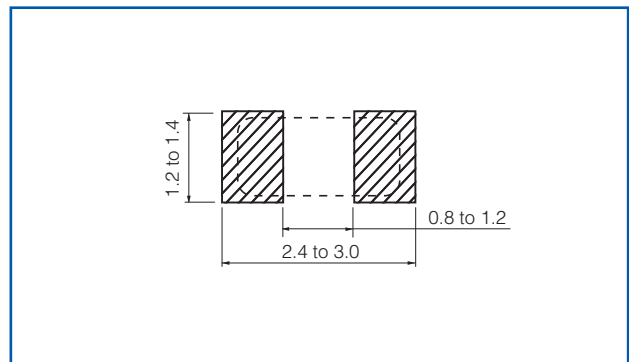

## Ratings and Characteristics

Part Number	Inductance at 1 MHz		DC Resistance at 20 °C (mΩ) max. (typ.)	Rated Current (A)	
	(μH)	Tol.		dL/L=-30% *1 max. (typ.)	dt/t=40 °C *2 max. (typ.)
ELGUEBR24MA	0.24	±20 %	29 (22)	3.7 (4.2)	3.7 (4.2)
ELGUEBR47MA	0.47	±20 %	52 (40)	3.2 (3.5)	3.2 (3.5)
ELGUEBR68MA	0.68	±20 %	75 (60)	2.4 (2.9)	2.9 (3.3)
ELGUEB1R0MA	1.0	±20 %	85 (70)	1.6 (1.9)	1.7 (1.9)
ELGUEB2R2MR	2.2	±20 %	108 (90)	0.7 (0.8)	1.6 (1.8)

● Operating Temperature Range : -40 to 125 °C (Including self-temperature rise)

\*1 This indicate the value of current when inductance change dL/L=-30 % from initial value.

\*2 This indicates the value of current when temperature rise dt/t=40 °C (at 20 °C).

## DC current bias characteristics

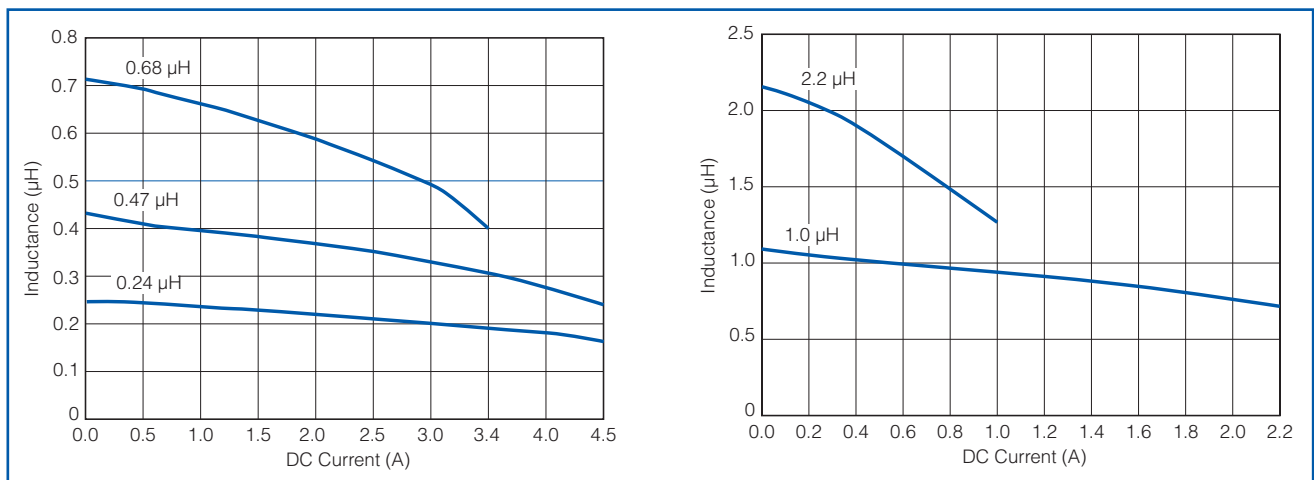

## Packaging Methods (Taping)

● Punched Carrier Taping (Pitch 4mm)

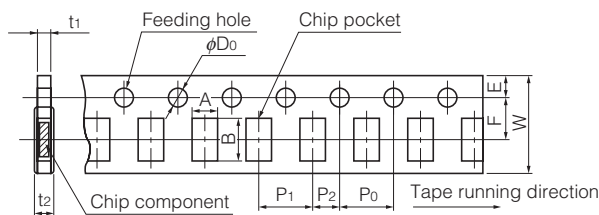

(Unit : mm)

Symbol	A	B	W	F	E	P <sub>1</sub>	P <sub>2</sub>	P <sub>0</sub>	φD <sub>0</sub>	t <sub>1</sub>	t <sub>2</sub>
Dim (mm)	2.0 ±0.2	2.4 ±0.2	8.0 ±0.2	3.50 ±0.05	1.75 ±0.10	4.0 ±0.1	2.00 ±0.05	4.0 ±0.1	1.5 +0.1/0	1.1 max.	1.4 max.

● Taping Reel

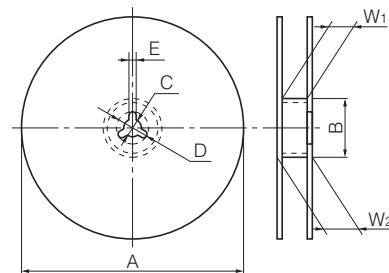

(Unit : mm)

Symbol	φA	φB	C	D	E	W <sub>1</sub>	W <sub>2</sub>
Dim (mm)	180 <sup>-0.3</sup>	60.0±0.5	13.0±0.5	21.0±0.8	2.0±0.5	9.0 <sup>+1.0/0</sup>	11.4±1.0

● Leader Part and Taped End

Leader part

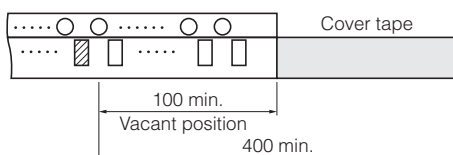

Tape end

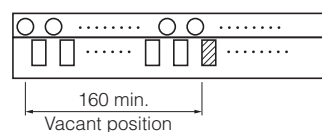

(Unit : mm)

## Multilayer Power Inductors

Type: **ELGTEA**

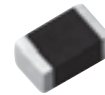

### Features

- Superior DC current bias characteristics by the original laminating process technology
- Magnetic shielded structure
- Small and thin structure (2.0×1.25×1.0mm max.)
- RoHS compliant

### Recommended Applications

- DC/DC converter circuit use of the small portable device  
Smart phone, mobile phone, DSC .

### Standard Packing Quantity

- 4000 pcs./Reel

### Explanation of Part Numbers

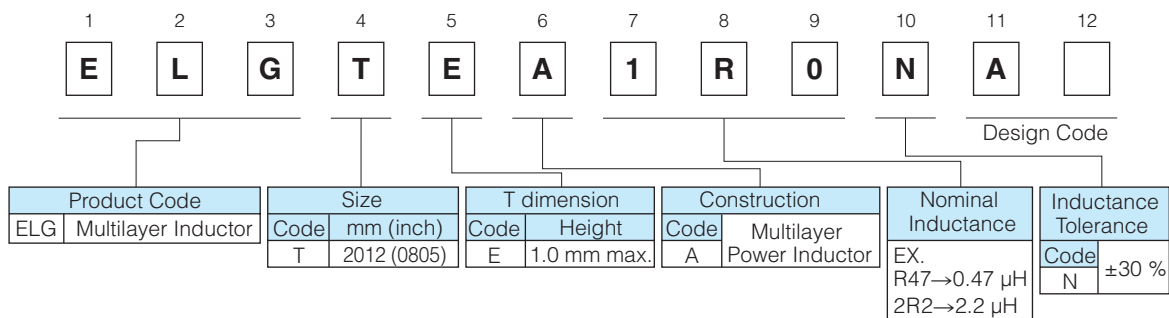

### Dimensions in mm (not to scale)

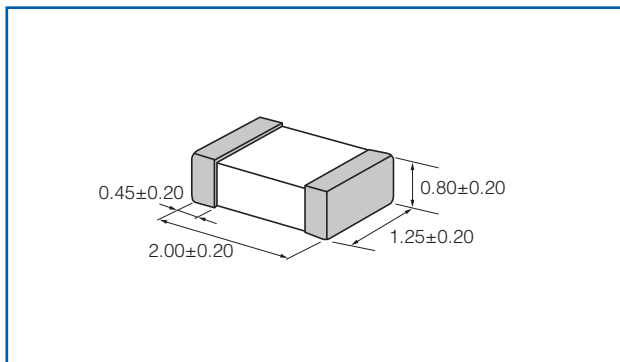

### Recommended Land Pattern in mm (not to scale)

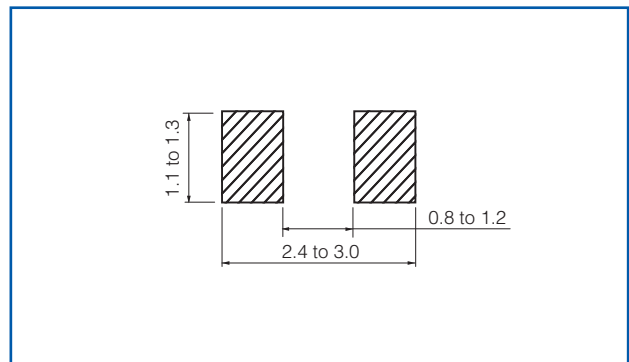

## Ratings and Characteristics

Part Number	Inductance at 1 MHz		DC Resistance at 20 °C (Ω) max.	Rated Current*1 (A)	Self-resonant Frequency*2 (MHz)
	(μH)	Tol.			
ELGTEAR47NA	0.47	±30 %	0.10	1.2	126
ELGTEA1R0NA	1.0	±30 %	0.15	1.0	80
ELGTEA1R5NA	1.5	±30 %	0.18	1.0	80
ELGTEA2R2NA	2.2	±30 %	0.20	0.8	55
ELGTEA3R3NA	3.3	±30 %	0.25	0.8	50
ELGTEA4R7NA	4.7	±30 %	0.30	0.8	33

● Operating Temperature Range : -40 to 125 °C (Including self-temperature rise)

\*1 This indicates the value of current when temperature rise dt/t=40 °C (at 20 °C).

\*2 Reference data

### Inductance frequency characteristics

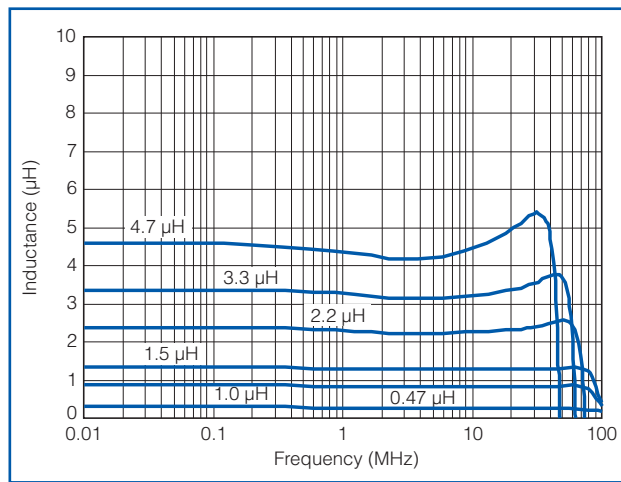

### DC current bias characteristics

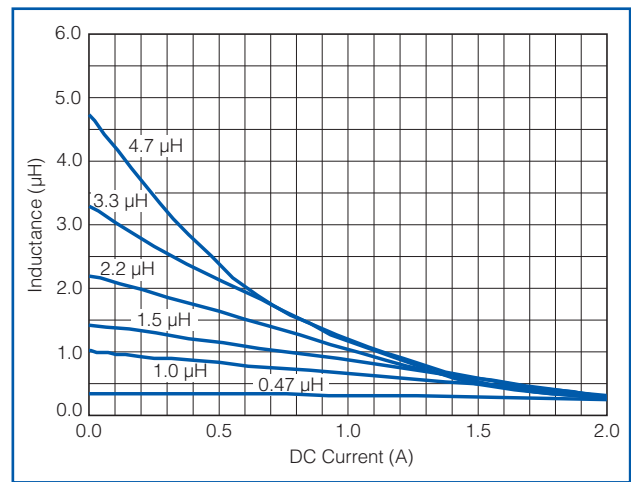

### Packaging Methods (Taping)

● Punched Carrier Taping (Pitch 4mm)

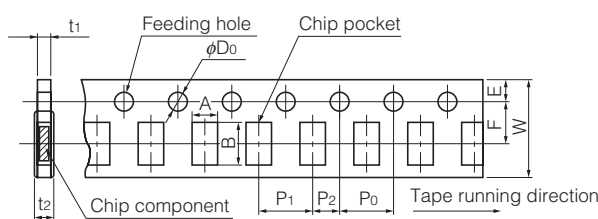

(Unit : mm)

Symbol	A	B	W	F	E	P <sub>1</sub>	P <sub>2</sub>	P <sub>0</sub>	φD <sub>0</sub>	t <sub>1</sub>	t <sub>2</sub>
Dim (mm)	1.65 ±0.20	2.4 ±0.2	8.0 ±0.2	3.50 ±0.05	1.75 ±0.10	4.0 ±0.1	2.00 ±0.05	4.0 ±0.1	1.5 +0.1/0	1.2 max.	1.4 max.

● Taping Reel

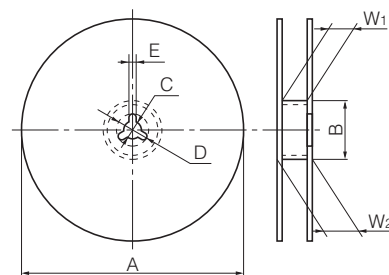

(Unit : mm)

Symbol	φA	φB	C	D	E	W <sub>1</sub>	W <sub>2</sub>
Dim (mm)	180 <sub>-3</sub>	60.0 <sub>+1.0</sub>	13.0±0.5	21.0±0.8	2.0±0.5	9.0 <sub>+1.0</sub>	11.4±1.0

● Leader Part and Taped End

Leader part

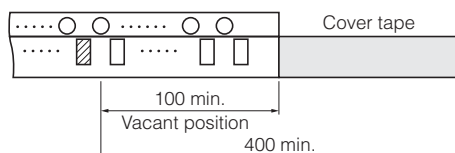

Tape end

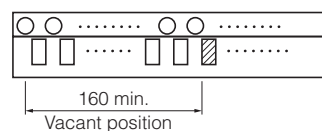

(Unit : mm)

## Multilayer Power Inductors

Type: **ELGTEA, ELGUEB**

### Handling Precautions

#### ⚠ Safety Precautions

Multilayer Power Inductors (hereafter referred to as "Inductors") should be used for general purpose applications in consumer electronics (audio/visual, home, office, information & communication) equipment. When subjected to severe electrical, environmental, and/or mechanical stress beyond the specifications, as noted in the Ratings and Specified Conditions section, the Inductors may fail in a short circuit mode or in an open-circuit mode. This case results in a burn-out, smoke or flaming.

For products which require high safety levels, please carefully consider how a single malfunction can affect your product. In order to ensure the safety in the case of a single malfunction, please design products with fail-safe, such as setting up protecting circuits, etc.

- For the following applications and conditions, please contact us for additional specifications not found in this document.
  - When your application may have difficulty complying with the safety or handling precautions specified below.
  - For any applications where a malfunction with this product may directly or indirectly cause hazardous conditions which could result in death or injury;
    - ① Aircraft and Aerospace Equipment (artificial satellite, rocket, etc.)
    - ② Submarine Equipment (submarine repeating equipment, etc.)
    - ③ Transport Equipment (motor vehicles, airplanes, trains, ship, traffic signal controllers, etc.)
    - ④ Power Generation Control Equipment (atomic power, hydroelectric power, thermal power plant control system, etc.)
    - ⑤ Medical Equipment (life-support equipment, pacemakers, dialysis controllers, etc.)
    - ⑥ Information Processing Equipment (large scale computer system, etc.)
    - ⑦ Electric Heating Appliances, Combustion devices (gas fan heaters, oil fan heaters, etc.)
    - ⑧ Rotary Motion Equipment
    - ⑨ Security Systems
    - ⑩ And any similar types of equipment

#### ⚠ Strict Observance

##### 1. Confirmation of Rated Performance

The Inductors shall be operated within the specified rating/performance.

Application exceeding the specifications may cause deteriorated performance and/or breakdown, resulting in degradation and/or smoking or ignition of products. The following are strictly observed.

- (1) The Inductors should be use within the specified operating temperature range including self-fever.
- (2) The electricity electric current of the inductor should be use in less than rated current.

##### 2. The Inductors shall not be mounted near inflammables.

##### 3. The inductors shall not be bring a magnet and the thing which became magnetized close.

### ■ Operating Conditions and Circuit Design

#### 1. Circuit Design

##### 1.1 Operating Temperature and Storage Temperature

The specified "Operating Temperature Range" found in the Specification is the absolute maximum and minimum temperature rating. Every Inductor shall be operated within the specified "Operating Temperature Range".

The Inductors mounted on PWB shall be stored without operating within the specified "Storage Temperature Range" in the Specifications.

##### 1.2 Operating Current

The Inductors shall not be operated in excess of the "Rated current". If the Inductors are operated beyond the specified "Rated current", it may cause

short and/or damage due to thermal run away. When high frequency and steep pulse current are continuously used, even when less than the "Rated current", in a circuit, please examine the reliability of the Inductor while also checking the safety and reliability of your circuit. Check safety and reliability in your circuit.

##### 1.3 Self-heating

The surface temperature of the Inductors shall be under the specified Maximum Operating Temperature in the Specifications including the temperature rise cause by self-heating. Check temperature rise of the Inductor in your circuit.



## 1.4 Environmental Restrictions

The Inductors shall not be operated and/or stored under the following conditions.

- (1) Environmental conditions
  - (a) Under direct exposure to water or salt water
  - (b) Under conditions where water can condense and/or dew can form
  - (c) Under conditions containing corrosive gases such as hydrogen sulfide, sulfurous acid, chlorine and ammonia
- (2) Mechanical conditions
 

Under severe conditions of vibration or impact beyond the specified conditions found in the Specifications.

## 2. Design of Printed Circuit Board

### 2.1 Selection of Printed Circuit Boards

When the Inductors are mounted and soldered on an "Alumina Substrate", the substrate influences the Inductors' reliability against "Temperature Cycles" and "Heat shock" due to the difference in the thermal expansion coefficient between them. Confirm that the actual board used does not deteriorate the characteristics of the Inductors.

### 2.2 Design of Land Pattern

- (1) Recommended land dimensions are shown below. Use the proper amount of solder in order to prevent cracking. Using too much solder places excessive stress on the Inductors.

Recommended Land Dimensions

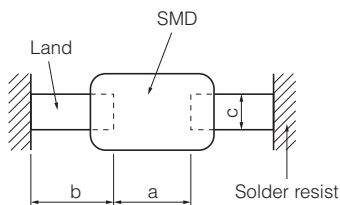

Unit (mm)

Size Code (inch)	Component dimensions			a	b	c
	L	W	T			
T(0805)	2.0	1.25	1.0 max.	0.8 to 1.2	0.6 to 1.1	1.1 to 1.3
U(0806)	2.0	1.60	1.0 max.	0.8 to 1.2	0.6 to 1.1	1.2 to 1.4

- (2) The size of lands shall be designed to have equal spacing between the right and left sides. If the amount of solder on the right land is different from that on the left land, the component may be cracked by stress since the side with a larger amount of solder solidifies later during cooling.

Recommended Amount of Solder

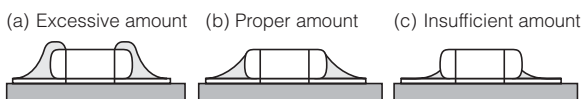

## 2.3 Utilization of Solder Resist

- (1) Solder resist shall be utilized to equalize the amounts of solder on both sides.
- (2) Solder resist shall be used to divide the pattern for the following cases;
  - Components are arranged closely.
  - The Inductor is mounted near a component with lead wires.
  - The Inductor is placed near a chassis.
 See the table below.

Prohibited Applications and Recommended Applications

Item	Prohibited applications	Improved applications by pattern division
Mixed mounting with a component with lead wires	The lead wire of a component with lead wires	Solder resist
Arrangement near chassis	Chassis Solder (Ground solder) Electrode pattern	Solder resist
Retro-fitting of component with lead wires	Soldering iron A lead wire of Retro-fitted component	Solder resist
Lateral arrangement	Portion to be excessively soldered Land	Solder resist

## 2.4 Component Layout

The Inductors/components shall be placed on the PC board such that both electrodes are subjected to uniform stresses, or to position the component electrodes at right angles to the grid glove or bending line. This should be done to avoid cracking the Inductors from bending the PC board after or during placing/mounting on the PC board.

- (1) To minimize mechanical stress caused by the warp or bending of a PC board, please follow the recommended Inductors' layout below.

Prohibited layout	Recommended layout
	 Layout the Inductor sideways against the stressing direction.

(2)The following layout is for your reference since mechanical stress near the dividing/breaking position of a PC board varies depending on the mounting position of the Inductors.

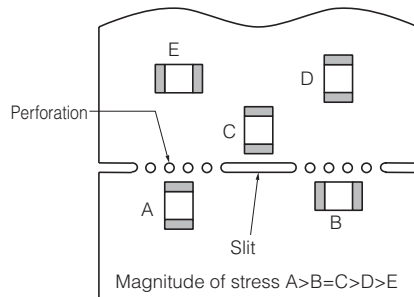

(3)The magnitude of mechanical stress applied to the Inductors when the circuit board is divided is in the order of push back < slit < V-groove < perforation.

Also take into account the layout of the Inductors and the dividing/breaking method.

## 2.5 Mounting Density and Spaces

If components are arranged in too narrow a space, the components can be affected by solder bridges and solder balls. The space between components should be carefully determined.

## ■ Precautions for Assembly

### 1. Storage

(1)The Inductors shall be stored between 5 - 40 °C and 20 - 70 %RH, not under severe conditions of high temperature and humidity.

(2)If stored in a place that is humid, dusty, or contains corrosive gasses (hydrogen sulfide, sulfurous acid, hydrogen chloride and ammonia etc.), the solderability of terminal electrodes may deteriorate.

In addition, storage in a place subjected to heating and/or exposure to direct sunlight will causes deformed tapes and reels, and component sticking to tapes, both of which can result in mounting problems.

(3)Do not store components longer than 6 months. Check the solderability of products that have been stored for more than 6 months before use.

### 2. Adhesives for Mounting

(1)The amount and viscosity of an adhesive for mounting shall be such that the adhesive shall not flow off on the land during its curing.

(2)If the amount of adhesive is insufficient for mounting, the Inductors may fall off after or during soldering.

(3)If the adhesive is too low in its viscosity, the Inductors may be out of alignment after or during soldering.

(4)Adhesives for mounting can be cured by ultraviolet or infrared radiation. In order to prevent the terminal electrodes of the Inductors from oxidizing, the curing shall be done under the following conditions:  
160 °C max., for 2 minutes max.

(5)Insufficient curing may cause the Inductors to fall off after or during soldering. In addition, insulation resistance between terminal electrodes may deteriorate due to moisture absorption. In order to prevent these problems, please observe proper curing conditions.

## 3. Chip Mounting Consideration

(1)When mounting the Inductors/components on a PC board, the Inductor bodies shall be free from excessive impact loads such as mechanical impact or stress due to the positioning, pushing force and displacement of vacuum nozzles during mounting.

(2)Maintenance and inspection of the Chip Mounter must be performed regularly.

(3)If the bottom dead center of the vacuum nozzle is too low, the Inductor will crack from excessive force during mounting.

The following precautions and recommendations are for your reference in use.

(a) Set and adjust the bottom dead center of the vacuum nozzles to the upper surface of the PC board after correcting the warp of the PC board.

(b) Set the pushing force of the vacuum nozzle during mounting to 1 to 3 N in static load.

(c) For double surface mounting, apply a supporting pin on the rear surface of the PC board to suppress the bending of the PC board in order to minimize the impact of the vacuum nozzles. Typical examples are shown in the table below.

Item	Prohibited mounting	Recommended mounting
Single surface mounting		
Double surface mounting		

(d) Adjust the vacuum nozzles so that their bottom dead center during mounting is not too low.

(4)The closing dimensions of the positioning chucks shall be controlled. Maintenance and replacement of positioning chucks shall be performed regularly to prevent chipping or cracking of the Inductors caused by mechanical impact during positioning due to worn positioning chucks.

(5) Maximum stroke of the nozzle shall be adjusted so that the maximum bending of PC board does not exceed 0.5mm at 90 mm span. The PC board shall be supported by an adequate number of supporting pins.

## 4. Selection of Soldering Flux

Soldering flux may seriously affect the performance of the Inductors. Please confirm whether soldering flux does not have an influence on performance of the Inductor before using enough.

## 5. Soldering

### 5.1 Reflow Soldering

The reflow soldering temperature conditions are each temperature curves of Preheating, Temp. rise, Heating, Peak and Gradual cooling. Large temperature difference caused by rapid heat application to the Inductors may lead to excessive thermal stresses, contributing to the thermal cracks. The Preheating temperature requires controlling with great care so that tombstone phenomenon may be prevented.

Item	Temperature	Period or Speed
① Preheating	140 to 180 °C	60 to 120 sec
② Temp. rise	Preheating temp to Peak temp.	2 to 5 °C /sec
③ Heating	220 °C min.	60 sec max.
④ Peak	260 °C max.	10 sec max.
⑤ Gradual cooling	Peak temp. to 140 °C	1 to 4 °C /sec

Recommended profile of Reflow soldering (EX)

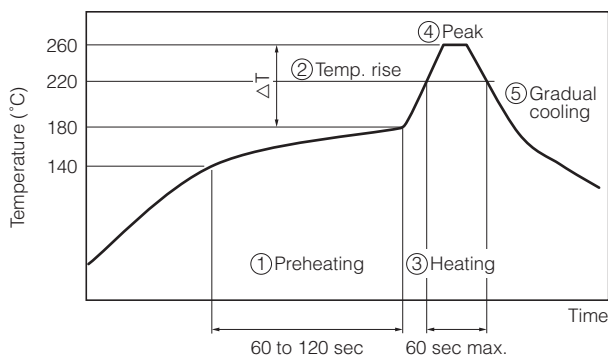

$\Delta T$  : Allowable temperature difference  $\Delta T \leq 150$  °C

The rapid cooling (forced cooling) during Gradual cooling part should be avoided, because this may cause defects such as the thermal cracks, etc.

When the Inductors are immersed into a cleaning solvent, make sure that the surface temperatures of the devices do not exceed 100 °C.

Performing reflow soldering twice under the conditions shown in the figure above [Recommended profile of Reflow soldering (EX)] will not cause any problems. However, pay attention to the possible warp and bending of the PC board.

### 5.2 Hand Soldering

Hand soldering typically causes significant temperature change, which may induce excessive thermal stresses inside the Inductors, resulting in the thermal cracks, etc. In order to prevent any defects, the following should be observed;

- The temperature of the soldering tips should be controlled with special care.
- The direct contact of soldering tips with the Inductors and/or terminal electrodes should be avoided.
- Dismounted Inductors shall not be reused.

#### (1) Condition 1 (with preheating)

##### (a) Soldering :

φ1.0 mm Thread eutectic solder with soldering flux\* in the core.

\*Rosin-based and non-activated flux is Recommended.

##### (b) Preheating :

The Inductors shall be preheated so that the "Temperature Gradient" between the devices and the tip of soldering iron is 150 °C or below.

##### (c) Temperature of Iron tip: 350 °C max.

(The required amount of solder shall be melted in advance on the soldering tip.)

##### (d) Gradual cooling :

After soldering, the Inductors shall be cooled gradually at room temperature.

Recommended profile of Hand soldering [EX]

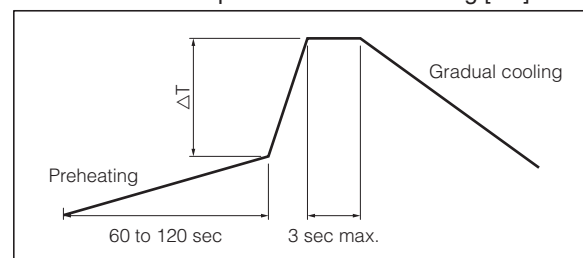

$\Delta T$  : Allowable temperature difference  $\Delta T \leq 150$  °C

#### (2) Condition 2 (without preheating)

Hand soldering can be performed without preheating, by following the conditions below:

(a) Soldering iron tip shall never directly touch the ceramic and terminal electrodes of the Inductors.

(b) The lands are sufficiently preheated with a soldering iron tip before sliding the soldering iron tip to the terminal electrodes of the Inductors for soldering.

Conditions of Hand soldering without preheating

	Condition
Temperature of Iron tip	270 °C max.
Wattage	20 W max.
Shape of Iron tip	φ3 mm max.
Soldering time with a soldering iron	3 sec max.

## 6. Post Soldering Cleaning

### 6.1 Cleaning solvent

Soldering flux residue may remain on the PC board if cleaned with an inappropriate solvent. This may deteriorate the electrical characteristics and reliability of the Inductors.

### 6.2 Cleaning conditions

Inappropriate cleaning conditions such as insufficient cleaning or excessive cleaning may impair the electrical characteristics and reliability of the Inductors.

- (1) Insufficient cleaning can lead to :
  - (a) The halogen substance found in the residue of the soldering flux may cause the metal of terminal electrodes to corrode.
  - (b) The halogen substance found in the residue of the soldering flux on the surface of the Inductors may change resistance values.
  - (c) Water-soluble soldering flux may have more remarkable tendencies of (a) and (b) above compared to those of rosin soldering flux.
- (2) Excessive cleaning can lead to :
  - (a) Overuse of ultrasonic cleaning may deteriorate the strength of the terminal electrodes or cause cracking in the solder and/or ceramic bodies of the Inductors due to vibration of the PC boards.  
Please follow these conditions for Ultrasonic cleaning :
    - Ultrasonic wave output : 20 W/L max.
    - Ultrasonic wave frequency : 40 kHz max.
    - Ultrasonic wave cleaning time : 5 min. max.

### 6.3 Contamination of Cleaning solvent

Cleaning with contaminated cleaning solvent may cause the same results as insufficient cleaning due to the high density of liberated halogen.

## 7. Inspection Process

When mounted PC boards are inspected with measuring terminal pins, abnormal and excess mechanical stress shall not be applied to the PC board or mounted components, to prevent failure or damage to the devices.

- (1) Mounted PC boards shall be supported by an adequate number of supporting pins with bend settings of 90 mm span 0.5 mm max.
- (2) Confirm that the measuring pins have the right tip shape, are equal in height and are set in the correct positions.  
The following figures are for your reference to avoid bending the PC board.

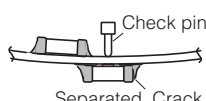
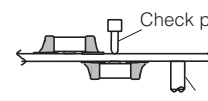
	Prohibited setting	Recommended setting
Bending of PC board	 Separated, Crack	 Supporting pin

## 8. Protective Coating

When the surface of a PC board on which the Inductors have been mounted is coated with resin to protect against moisture and dust, it shall be confirmed that the protective coating which is corrosive or chemically active is not used, in order that the reliability of the Inductors in the actual equipment may not be influenced. Coating materials that expand or shrink also may lead to damage to the Inductor during the curing process.

## 9. Dividing/Breaking of PC Boards

- (1) Abnormal and excessive mechanical stress such as bending or torsion shown below can cause cracking in the Inductors.

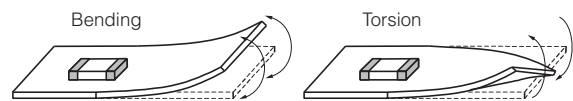

- (2) Dividing/Breaking of the PC boards shall be done carefully at moderate speed by using a jig or apparatus to prevent the Inductors on the boards from mechanical damage.

- (3) Examples of PWB dividing/breaking jigs :  
The outline of PC board breaking jig is shown below.

When PC board are broken or divided, loading points should be close to the jig to minimize the extent of the bending.

Also, planes with no parts mounted on should be used as plane of loading, which generates a compressive stress on the mounted plane, in order to prevent tensile stress induced by the bending, which may cause cracks of the Inductors or other parts mounted on the PC boards.

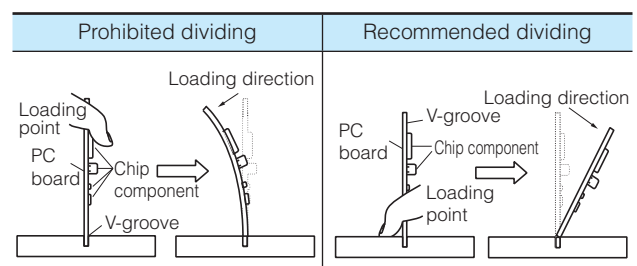
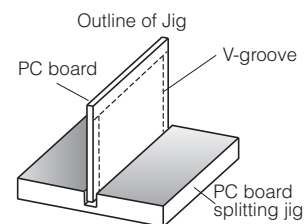

## 10. Mechanical Impact

- (1) The Inductors shall be free from any excessive mechanical impact. The Inductor body is made of ceramics and may be damaged or cracked if dropped. Never use an Inductor which has been dropped; their quality may be impaired and failure rate increased.
- (2) When handling PC boards with Inductors mounted on them, do not allow the Inductors to collide with another PC board. When mounted PC boards are handled or stored in a stacked state, impact between the corner of a PC board and the Inductor may cause damage or cracking and can deteriorate the withstand voltage and insulation resistance of the Inductor.

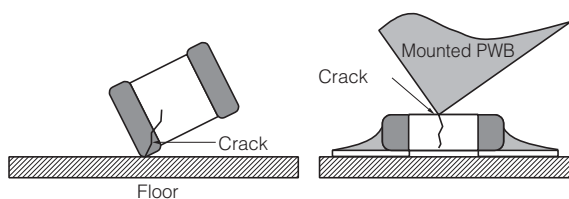

### ■ Other

The various precautions described above are typical. For special mounting conditions, please contact us.

## Power Inductors / Wire Wound type

Series : **G**  
 Type : **ELLVEG**  
**ELLVFG-C**  
**ELLVGG**  
**ELLVGG-C**

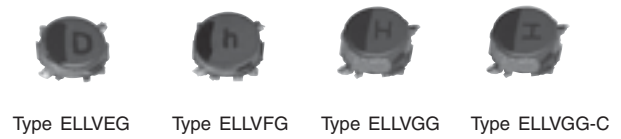

### Features

- Magnetic shielded structure
- Low DC resistance and large current capability
- Shock resistant
- RoHS compliant

### Recommended Applications

- DSC, Tablet terminal, Portable game device, DC/DC converter circuit for cellular phone

### Standard Packing Quantity

- 2,000 pcs./reel

### As for Soldering Conditions and Safety Precautions,

Please see Data Files

### Explanation of Part Numbers

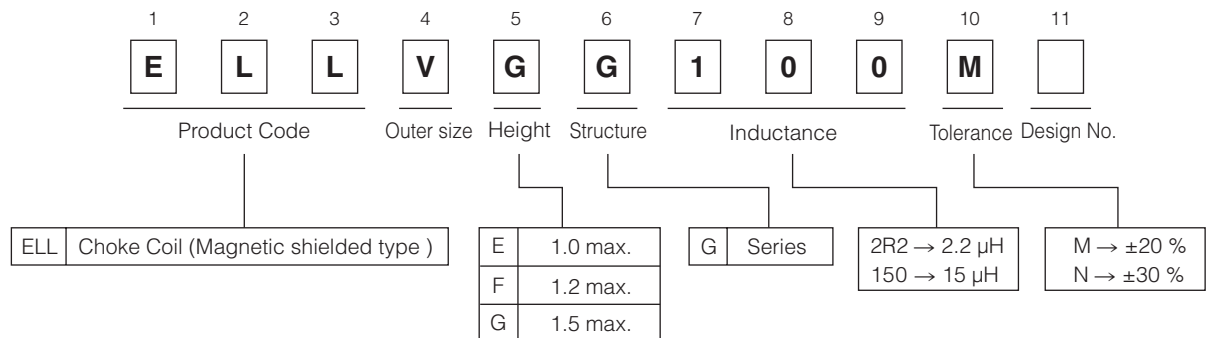

### Dimensions in mm (not to scale)

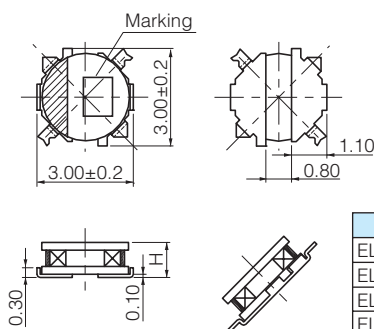

Type	H
ELLVEG	1.0 max.
ELLVFG-C	1.2 max.
ELLVGG	1.5 max.
ELLVGG-C	1.5 max.

### Recommended land patterns in mm (not to scale)

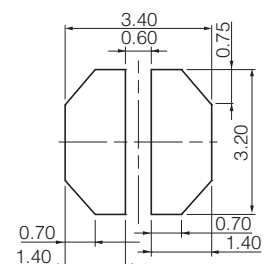

## Standard Parts

Series	Part No.	Inductance (100 kHz)		R <sub>DC</sub> (at 20 °C)		Saturation Rated Current*1 (mA max.)	Temperature Rise Current*2 (mA max.)	Marking
		(μH)	Tol.	(mΩ)	Tol.			
Series VEG	ELLVEGR68N	0.68	±30 %	50	±20 %	1950	1800	7
	ELLVEG1R0N	1.0		61		1900	1600	A
	ELLVEG1R5N	1.5		74		1200	1400	C
	ELLVEG2R2N	2.2		110		1100	1250	D
	ELLVEG3R3N	3.3		210		1000	820	E
	ELLVEG4R7N	4.7		240		750	770	H
	ELLVEG6R8N	6.8	350	580		650	K	
	ELLVEG100M	10.0	480	520		600	M	
	ELLVEG150M	15.0	710	430		490	O	
ELLVEG220M	22.0	1200	330	400	R			
Series VFG-C	ELLVFG1R0NC	1.0	±30 %	50	±20 %	1500	1700	a
	ELLVFG1R5NC	1.5		61		1300	1550	c
	ELLVFG2R2NC	2.2		87		1100	1400	d
	ELLVFG3R3NC	3.3		110		980	1250	e
	ELLVFG4R7NC	4.7		150		740	1050	h
	ELLVFG6R8NC	6.8		230		600	840	k
	ELLVFG100MC	10.0	380	550		640	m	
	ELLVFG150MC	15.0	540	500		480	o	
	ELLVFG220MC	22.0	710	350		430	r	
ELLVFG330MC	33.0	1160	280	330	t			
Series VGG	ELLVGG1R0N	1.0	±30 %	52	±20 %	2200	1800	A
	ELLVGG1R2N	1.2		61		2000	1600	B
	ELLVGG1R6N	1.6		73		1800	1550	C
	ELLVGG2R2N	2.2		92		1600	1400	D
	ELLVGG3R3N	3.3		130		1350	1100	E
	ELLVGG3R9N	3.9		150		1300	1000	F
	ELLVGG4R7N	4.7	170	1200		980	H	
	ELLVGG6R8N	6.8	230	1000		800	K	
	ELLVGG100M	10.0	280	800		730	M	
	ELLVGG120M	12.0	480	690		580	N	
	ELLVGG150M	15.0	640	600		490	O	
	ELLVGG220M	22.0	800	500		460	R	
ELLVGG330M	33.0	1330	450	340	T			
ELLVGG470M	47.0	2100	350	270	V			
Series VGG-C	ELLVGG1R0NC	1.0	±30 %	47	±20 %	1400	2000	◁
	ELLVGG2R2NC	2.2		79		1050	1500	▷
	ELLVGG3R3NC	3.3		110		1000	1300	≡
	ELLVGG4R7NC	4.7		130		900	1200	≡
	ELLVGG6R8NC	6.8		180		700	1000	≡
	ELLVGG100MC	10.0		260		600	860	≡
	ELLVGG120MC	12.0	280	550		730	Z	
	ELLVGG150MC	15.0	420	450		670	O	
	ELLVGG220MC	22.0	530	410		600	R	
	ELLVGG330MC	33.0	790	350		450	F	
	ELLVGG470MC	47.0	1200	260		360	>	
	ELLVGG101MC	100	2950	180		250	N	

\*1 Saturation Rated Current : This DC current which causes a 30 % inductance reduction from its nominal value.

\*2 Temperature Rise Current : This indicates the value of current when temperature rise dt/t= 40 °C (at 20 °C).





## Power Inductors / Wire Wound type

Series : **G**  
 Type : **ELL4FG-A**  
**ELL4GG**  
**ELL4LG-A**



Type ELL4FG-A



Type ELL4GG



Type ELL4LG-A

### Features

- Magnetic shielded structure
- Low DC resistance and large current capability
- Shock resistant
- RoHS compliant

### Recommended Applications

- DSC, Tablet terminal, Portable game device, DC/DC converter circuit for cellular phone

### Standard Packing Quantity

- 2,000 pcs./reel (ELL4FG-A/ELL4GG)
- 3,000 pcs./reel (ELL4LG-A)

### As for Soldering Conditions and Safety Precautions,

Please see Data Files

### Explanation of Part Numbers

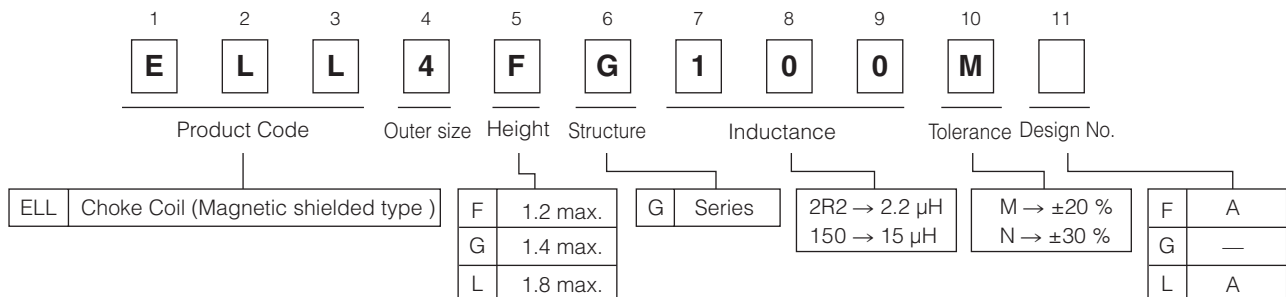

### Dimensions in mm (not to scale)

- ELL4FG-A
- ELL4LG-A

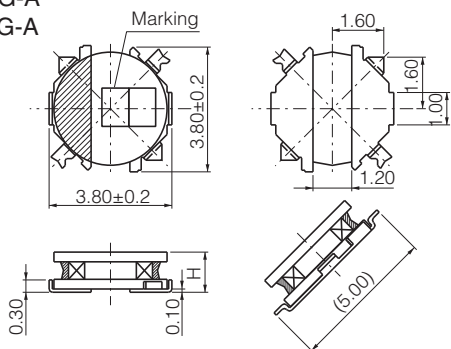

Type	H
ELL4FG-A	1.1±0.10 (1.20 max.)
ELL4LG-A	1.80 max.

- ELL4GG

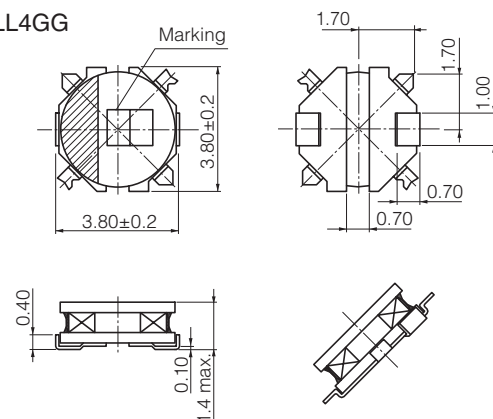

## Recommended land patterns in mm (not to scale)

- ELL4FG-A
- ELL4LG-A

- ELL4GG

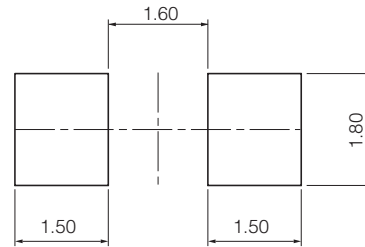
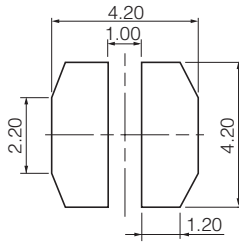

## Standard Parts

Series	Part No.	Inductance (100 kHz)		R <sub>DC</sub> (at 20 °C)		Saturation Rated Current*1 (mA max.)	Temperature Rise Current*2 (mA max.)	Marking
		(μH)	Tol.	(mΩ)	Tol.			
Series 4FG-A	ELL4FG1R0NA	1.0	±30 %	45	±20 %	1900	1950	01
	ELL4FG1R5NA	1.5		60		1600	1700	06
	ELL4FG2R0NA	2.0		70		1300	1550	10
	ELL4FG3R3NA	3.3		110		1100	1220	16
	ELL4FG4R7NA	4.7		160		1000	1000	21
	ELL4FG6R8NA	6.8	±20 %	220		800	860	26
	ELL4FG100MA	10.0		290		700	750	31
	ELL4FG150MA	15.0		480		600	580	33
	ELL4FG220MA	22.0		620		420	500	36
	ELL4FG330MA	33.0		1060		360	400	39
ELL4FG470MA	47.0	1600	290	330	51			
Series 4GG	ELL4GG1R2N	1.2	±30 %	50	±20 %	2400	1900	03
	ELL4GG1R8N	1.8		71		1900	1550	09
	ELL4GG2R2N	2.2		88		1700	1400	11
	ELL4GG3R3N	3.3		110		1500	1200	16
	ELL4GG3R9N	3.9		120		1400	1150	19
	ELL4GG4R7N	4.7		160		1200	1000	21
	ELL4GG5R6N	5.6		170		1100	970	23
	ELL4GG6R8N	6.8	200	1050		930	26	
	ELL4GG8R2N	8.2	220	1000		870	29	
	ELL4GG100M	10.0	±20 %	250		900	770	31
	ELL4GG120M	12.0		380		800	650	32
	ELL4GG150M	15.0		500		700	580	33
	ELL4GG220M	22.0		640		600	500	36
	ELL4GG330M	33.0		980		450	400	39
ELL4GG470M	47.0	1250		400	350	51		
ELL4GG101M	100.0	2400		290	250	56		
Series 4LG-A	ELL4LG1R0NA	1.0	±30 %	43	±20 %	2200	1900	01
	ELL4LG1R5NA	1.5		48		1700	1800	06
	ELL4LG2R2NA	2.2		55		1500	1700	11
	ELL4LG2R7NA	2.7		63		1400	1550	13
	ELL4LG3R3NA	3.3		72		1300	1450	16
	ELL4LG4R7NA	4.7	90	1100		1300	21	
	ELL4LG6R2NA	6.2	140	930		1100	25	
	ELL4LG100MA	10.0	±20 %	200		800	950	31
	ELL4LG150MA	15.0		300		620	730	33
	ELL4LG220MA	22.0		390		550	640	36
	ELL4LG330MA	33.0		610		430	510	39
	ELL4LG470MA	47.0		920		360	410	51
	ELL4LG680MA	68.0		1300		270	350	53
	ELL4LG101MA	100.0		2200		250	260	56
ELL4LG151MA	150.0	3000		220	220	59		

\*1 Saturation Rated Current : This DC current which causes a 30 % inductance reduction from its nominal value.

\*2 Temperature Rise Current : This indicates the value of current when temperature rise dt/t= 40 °C (at 20 °C).

Design and specifications are each subject to change without notice. Ask factory for the current technical specifications before purchase and/or use.  
Should a safety concern arise regarding this product, please be sure to contact us immediately.

## Embossed Carrier Tape Dimensions in mm (not to scale)

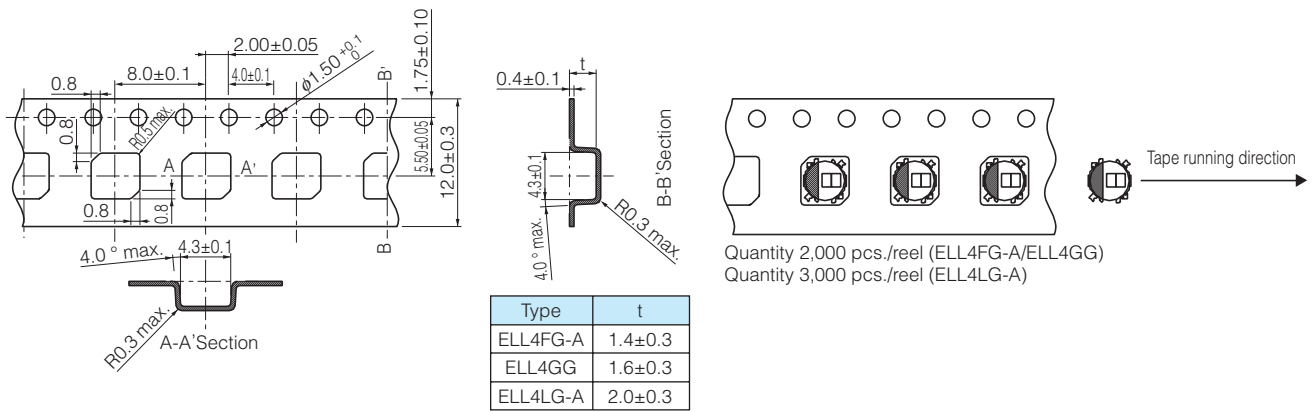

## Power Inductors / Wire Wound type

Series : **G**  
 Type : **ELL6GG**  
**ELL6PG**



### Features

- Magnetic shielded structure
- Low DC resistance and large current capability
- RoHS compliant

### Recommended Applications

- DSC, Tablet terminal, Portable game device, DC/DC converter circuit for cellular phone

### Standard Packing Quantity

- 1,000 pcs./reel

### As for Soldering Conditions and Safety Precautions,

Please see Data Files

### Explanation of Part Numbers

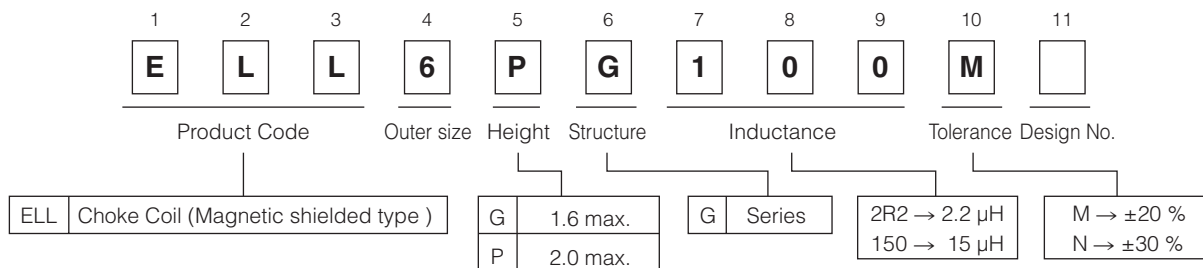

### Dimensions in mm (not to scale)

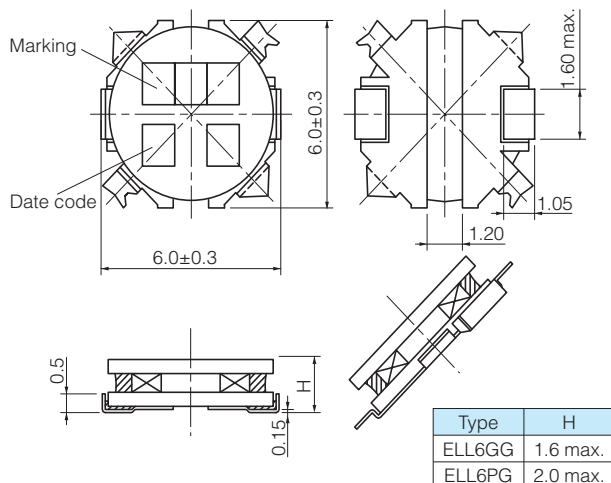

### Recommended land patterns in mm (not to scale)

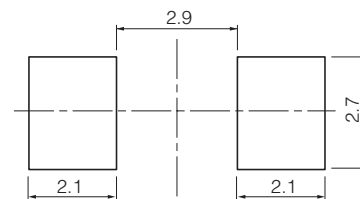

## Standard Parts

Series	Part No.	Inductance (100 kHz)		Rbc (at 20 °C)		Saturation Rated Current*1 (mA max.)	Temperature Rise Current*2 (mA max.)	Marking
		(μH)	Tol.	(mΩ)	Tol.			
Series 6GG	ELL6GG1R0N	1.0	±30 %	27	±20 %	2500	2500	1R0
	ELL6GG1R5N	1.5		36		2300	2250	1R5
	ELL6GG2R2M	2.2		45		1950	2000	2R2
	ELL6GG2R7M	2.7	54	1850		1800	2R7	
	ELL6GG3R9M	3.9	60	1650		1700	3R9	
	ELL6GG4R7M	4.7	70	1400		1550	4R7	
	ELL6GG6R8M	6.8	110	1150		1300	6R8	
	ELL6GG100M	10.0	170	900		1000	100	
	ELL6GG150M	15.0	210	800		900	150	
	ELL6GG220M	22.0	300	620		850	220	
	ELL6GG330M	33.0	510	490		580	330	
	ELL6GG470M	47.0	610	400		480	470	
	ELL6GG680M	68.0	860	380		410	680	
	ELL6GG101M	100.0	1480	300		350	101	
Series 6PG	ELL6PGR08N	0.8	±30 %	24	±20 %	3800	2800	R08
	ELL6PG1R5N	1.5		30		2500	2500	1R5
	ELL6PG2R2N	2.2		37		2200	2200	2R2
	ELL6PG3R3N	3.3		44		1700	2000	3R3
	ELL6PG3R9N	3.9		51		1600	1900	3R9
	ELL6PG4R7N	4.7		58		1500	1750	4R7
	ELL6PG5R6N	5.6		65		1450	1650	5R6
	ELL6PG6R8N	6.8		70		1400	1600	6R8
	ELL6PG100M	10.0	110	1300		1300	100	
	ELL6PG120M	12.0	140	1100		1200	120	
	ELL6PG150M	15.0	150	1000		1100	150	
	ELL6PG220M	22.0	230	800		900	220	
	ELL6PG270M	27.0	260	730		800	270	
	ELL6PG330M	33.0	300	700		750	330	
	ELL6PG470M	47.0	470	550		600	470	
	ELL6PG560M	56.0	520	500		550	560	
	ELL6PG680M	68.0	700	420		500	680	
	ELL6PG820M	82.0	800	400		450	820	
ELL6PG101M	100.0	1000	380	400	101			

\*1 Saturation Rated Current : This DC current which causes a 30 % inductance reduction from its nominal value.

\*2 Temperature Rise Current : This indicates the value of current when temperature rise  $dt/t = 40\text{ °C}$  (at 20 °C).

## Embossed Carrier Tape Dimensions in mm (not to scale)

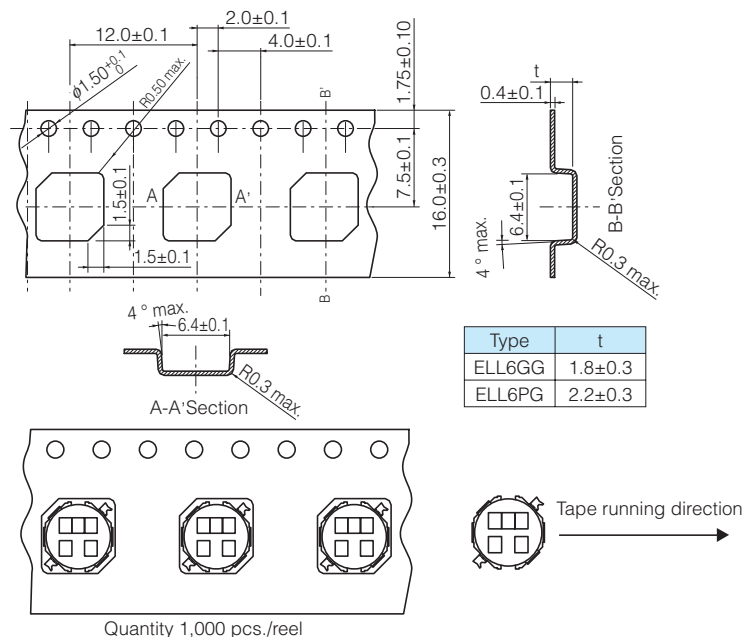

Design and specifications are each subject to change without notice. Ask factory for the current technical specifications before purchase and/or use.  
Should a safety concern arise regarding this product, please be sure to contact us immediately.

## Power Inductors / Wire Wound type

Series : **H**  
 Type : **ELL6RH**  
           **ELL6SH**  
           **ELL6UH**

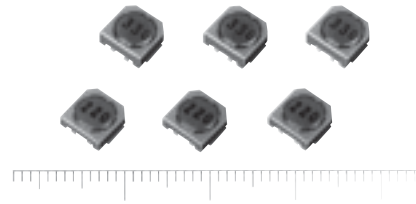

### Features

- Thin (height 2.5 mm, 3.0 mm)
- Higher reliability in mounting by separating the user terminal and internal connection.
- Large current capability
- RoHS compliant

### Recommended Applications

- Audiovisual equipment, Small portable device, DC/DC converter circuit for amusement machine

### Cautionary Notes Regarding Usage in DC/DC converters

- Maximum Dissipation of 1 W.
- Maximum case temperature of 105 °C (Ambient & self-heating temperature)

### Standard Packing Quantity

- 1,000 pcs./reel

### As for Soldering Conditions and Safety Precautions,

Please see Data Files

### Explanation of Part Numbers

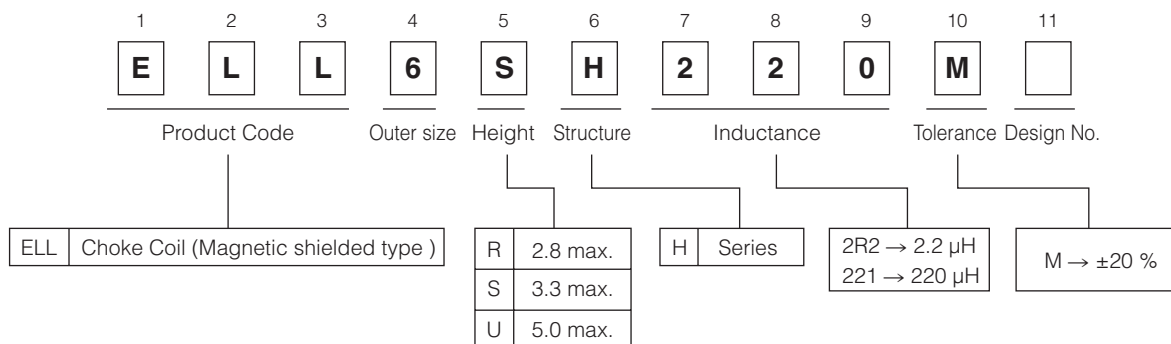

## Dimensions in mm (not to scale)

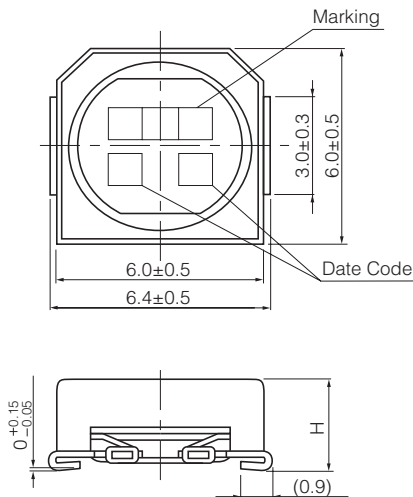

Type	H
ELL6RH	2.5 mm±0.3 mm
ELL6SH	3.0 mm±0.3 mm
ELL6UH	5.0 mm max.

## Connections (Top view)

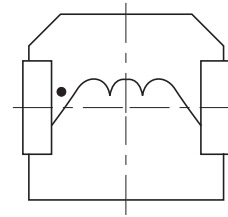

## Recommended land patterns in mm (not to scale)

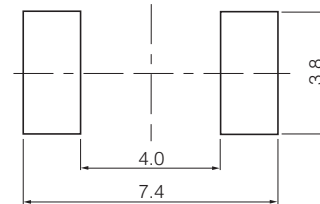

## Standard Parts

Part No.	Inductance (μH) at 100 kHz Tol. ±20 %	R <sub>DC</sub> (mΩ) at 20 °C Tol. ±20 %		Rated Current* (mA) max.		Marking
		6RH	6SH	6RH	6SH	
ELL6□H1R0M	1.0	19	19	3000	3400	1R0
ELL6□H1R5M	1.5	24	24	2400	3200	1R5
ELL6□H2R0M	2.0	—	26	—	2600	2R0
ELL6□H2R2M	2.2	30	—	2300	—	2R2
ELL6□H2R7M	2.7	39	31	1800	2400	2R7
ELL6□H3R3M	3.3	44	34	1600	2200	3R3
ELL6□H4R7M	4.7	49	42	1580	2000	4R7
ELL6□H5R1M	5.1	56	—	1550	—	5R1
ELL6□H5R6M	5.6	—	49	—	1800	5R6
ELL6□H6R2M	6.2	62	—	1400	—	6R2
ELL6□H6R8M	6.8	—	52	—	1500	6R8
ELL6□H7R5M	7.5	80	—	1250	—	7R5
ELL6□H8R2M	8.2	87	61	1200	1400	8R2
ELL6□H100M	10.0	95	65	1100	1300	100
ELL6□H120M	12.0	130	71	1000	1200	120
ELL6□H150M	15.0	150	96	850	1100	150
ELL6□H180M	18.0	170	130	800	1000	180
ELL6□H220M	22.0	220	140	700	900	220
ELL6□H270M	27.0	260	160	650	800	270
ELL6□H330M	33.0	380	180	600	700	330
ELL6□H390M	39.0	410	240	550	650	390
ELL6□H470M	47.0	480	270	500	600	470
ELL6□H560M	56.0	540	290	450	550	560
ELL6□H680M	68.0	770	520	400	500	680
ELL6□H820M	82.0	870	600	350	450	820
ELL6□H101M	100.0	1000	680	300	400	101
ELL6□H121M	120.0	1500	750	280	370	121
ELL6□H151M	150.0	1800	860	250	350	151
ELL6□H181M	180.0	2000	1300	230	300	181
ELL6□H221M	220.0	2300	1400	200	280	221
ELL6□H271M	270.0	—	2400	—	260	271
ELL6□H331M	330.0	—	2700	—	240	331
ELL6□H391M	390.0	—	2800	—	210	391
ELL6□H471M	470.0	—	3200	—	200	471
ELL6□H561M	560.0	—	3700	—	180	561
ELL6□H681M	680.0	—	4300	—	160	681

\* Current : This indicates the value of current when the inductance is 80% of nominal value or when the case temperature has risen 45 °C.

Design and specifications are each subject to change without notice. Ask factory for the current technical specifications before purchase and/or use.  
Should a safety concern arise regarding this product, please be sure to contact us immediately.

## Standard Parts

Part No.	Inductance ( $\mu\text{H}$ ) at 100 kHz Tol. $\pm 20\%$	$R_{bc}$ ( $\text{m}\Omega$ ) at 20 °C Tol. $\pm 20\%$	Rated Current* (mA) max.	Marking
ELL6UH100M	10.0	63	1800	100
ELL6UH120M	12.0	71	1700	120
ELL6UH150M	15.0	79	1600	150
ELL6UH180M	18.0	88	1400	180
ELL6UH220M	22.0	98	1300	220
ELL6UH270M	27.0	110	1200	270
ELL6UH330M	33.0	130	1100	330
ELL6UH390M	39.0	150	1000	390
ELL6UH470M	47.0	160	900	470
ELL6UH560M	56.0	210	800	560
ELL6UH680M	68.0	230	700	680
ELL6UH820M	82.0	260	650	820
ELL6UH101M	100.0	360	600	101
ELL6UH121M	120.0	480	580	121
ELL6UH151M	150.0	680	500	151
ELL6UH181M	180.0	750	470	181
ELL6UH221M	220.0	840	410	221
ELL6UH271M	270.0	1200	370	271
ELL6UH331M	330.0	1360	330	331
ELL6UH391M	390.0	1500	300	391
ELL6UH471M	470.0	1680	270	471
ELL6UH561M	560.0	2530	260	561
ELL6UH681M	680.0	2830	240	681
ELL6UH821M	820.0	3140	200	821
ELL6UH102M	1000.0	3670	180	102

\* Current : This indicates the value of current when the inductance is 70% of nominal value or when the case temperature has risen 45 °C.

## Embossed Carrier Tape Dimensions in mm (not to scale)

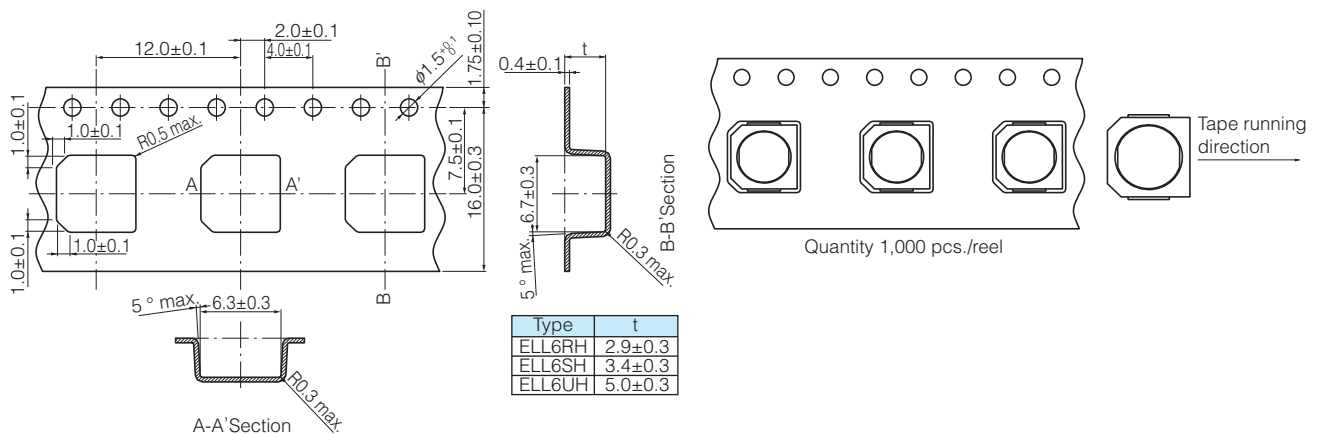



## Power Inductors / Wire Wound type

Series : **P**  
Type : **ELL8TP**

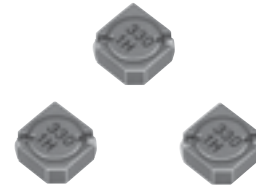

### Features

- Magnetic shielded structure
- Low DC resistance and large current capability
- Available on tape and reel for automatic insertion
- RoHS compliant

### Recommended Applications

- Audiovisual equipment, Appliance, Office automation equipment, Amusement machine, Power circuit for electric device

### Standard Packing Quantity

- 500 pcs./reel

### As for Soldering Conditions and Safety Precautions,

Please see Data Files

### Explanation of Part Numbers

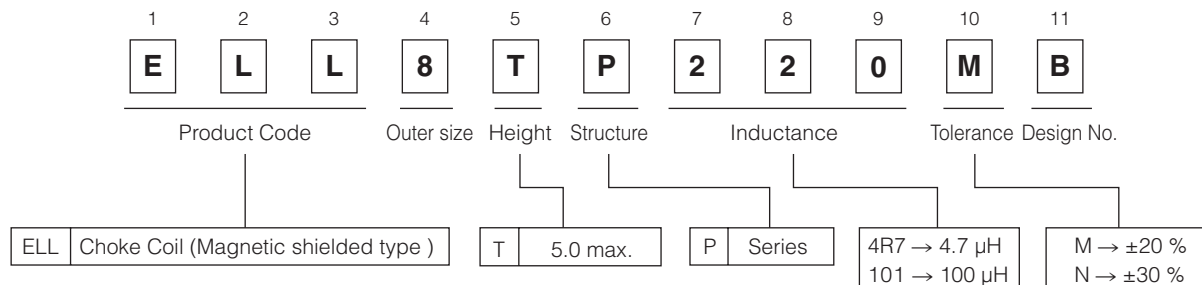

### Dimensions in mm (not to scale)

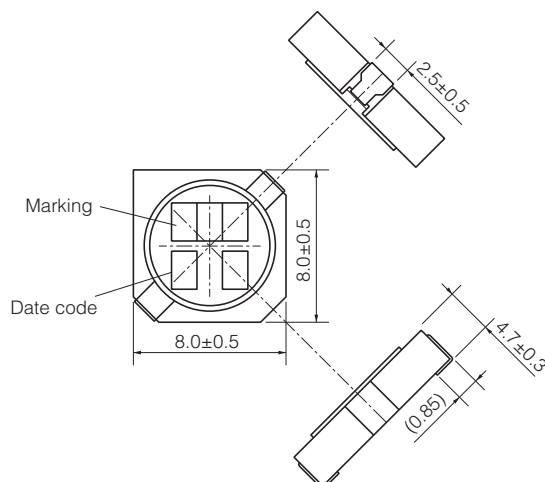

### Recommended land patterns in mm (not to scale)

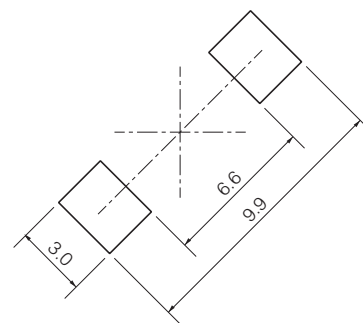

## Standard Parts

Part No.	Inductance (100 kHz)		R <sub>DC</sub> (at 20 °C)		Saturation Rated Current* <sup>1</sup> (mA max.)	Temperature Rise Current* <sup>2</sup> (mA max.)	Marking
	(μH)	Tol.	(mΩ)	Tol.			
ELL8TPR80NB	0.8	±30 %	3.6	±30 %	9500	9000	R80
ELL8TP1R2NB	1.2		4.7		8500	8000	1R2
ELL8TP2R5NB	2.5		7		5500	6500	2R5
ELL8TP3R3NB	3.3		13		5000	4200	3R3
ELL8TP4R7NB	4.7		14		4000	4000	4R7
ELL8TP6R8NB	6.8		18		3500	3500	6R8
ELL8TP100MB	10.0	±20 %	25	±20 %	3000	3000	100
ELL8TP150MB	15.0		44		2300	2300	150
ELL8TP220MB	22.0		55		2200	2000	220
ELL8TP330MB	33.0		84		1600	1600	330
ELL8TP470MB	47.0		100		1400	1500	470
ELL8TP680MB	68.0		140		1000	1300	680
ELL8TP101MB	100.0		190		900	1100	101
ELL8TP151MB	150.0		340		700	800	151
ELL8TP221MB	220.0		480		550	700	221
ELL8TP331MB	330.0		700		450	570	331
ELL8TP471MB	470.0		1000		400	480	471
ELL8TP681MB	680.0		1300		300	430	681
ELL8TP102MB	1000.0		2100		250	330	102

\*1 Saturation Rated Current : This DC current which causes a 30% inductance reduction from its nominal value.

\*2 Temperature Rise Current : This indicates the value of current when temperature rise dt/t= 40 °C (at 20 °C).

## Embossed Carrier Tape Dimensions in mm (not to scale)

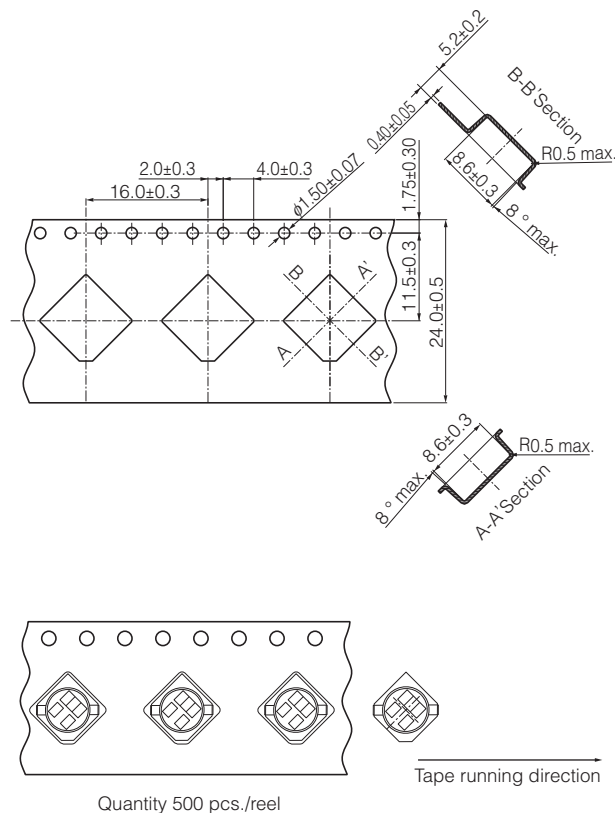

## Power Inductors / Wire Wound type

Series : **P**  
Type : **ELLATP**

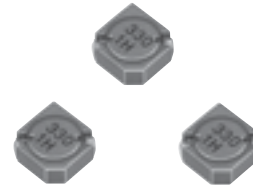

### Features

- Magnetic shielded structure
- Low DC resistance and large current capability
- Available on tape and reel for automatic insertion
- The new version of ELLATV serie
- RoHS compliant

### Recommended Applications

- Audiovisual equipment, Appliance, Office automation equipment, Amusement machine, Power circuit for electric device

### Standard Packing Quantity

- 500 pcs./reel

### As for Soldering Conditions and Safety Precautions,

Please see Data Files

### Explanation of Part Numbers

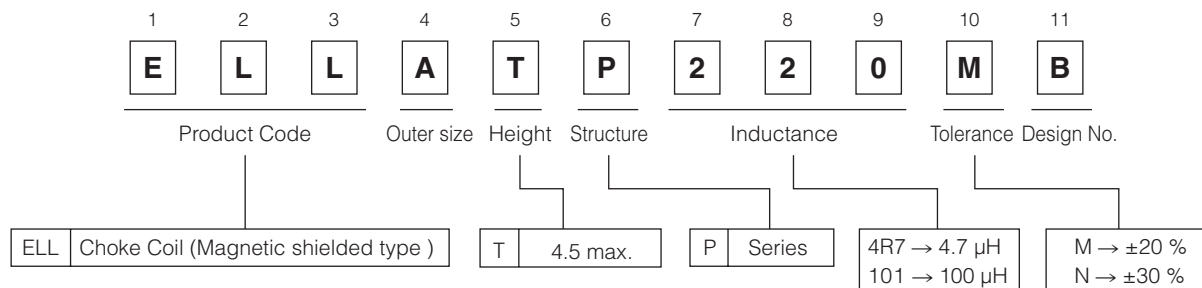

### Dimensions in mm (not to scale)

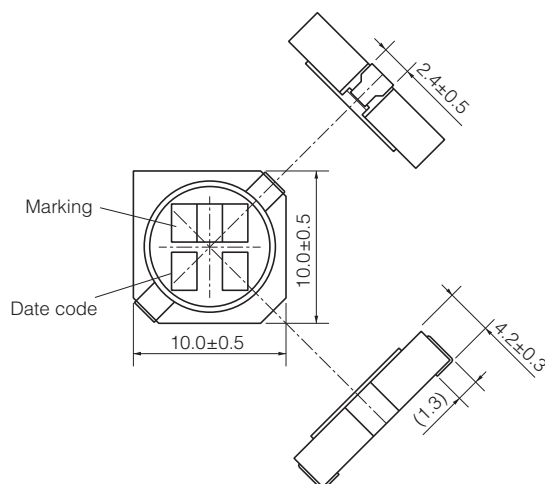

### Recommended land patterns in mm (not to scale)

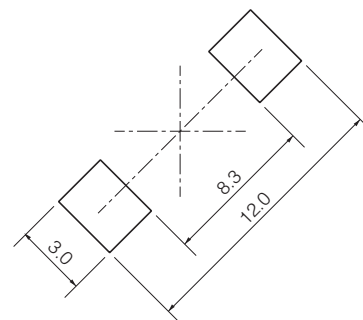

## Standard Parts

Part No.	Inductance (100 kHz)		Rbc (at 20 °C)		Saturation Rated Current*1 (mA max.)	Temperature Rise Current*2 (mA max.)	Marking
	(μH)	Tol.	(mΩ)	Tol.			
ELLATP1R0NB	1.0	±30 %	3.6	±30 %	9000	8000	1R0
ELLATP1R5NB	1.5		4.4		8000	7000	1R5
ELLATP2R7NB	2.7		6.4		5500	6500	2R7
ELLATP3R3NB	3.3		7.5		5350	5500	3R3
ELLATP4R7NB	4.7		9.1		4500	5000	4R7
ELLATP5R1NB	5.1		12		4350	4500	5R1
ELLATP6R8NB	6.8		15		4000	4000	6R8
ELLATP8R2NB	8.2		18		3700	3700	8R2
ELLATP100MB	10.0		22		3300	3300	100
ELLATP120MB	12.0		25		2900	2900	120
ELLATP150MB	15.0	29	2700	2700	150		
ELLATP220MB	22.0	38	2200	2500	220		
ELLATP270MB	27.0	47	1900	2200	270		
ELLATP330MB	33.0	59	1800	2000	330		
ELLATP390MB	39.0	66	1600	1800	390		
ELLATP470MB	47.0	80	1500	1700	470		
ELLATP680MB	68.0	120	1100	1400	680		
ELLATP820MB	82.0	140	1050	1300	820		
ELLATP101MB	100.0	180	1000	1200	101		
ELLATP121MB	120.0	200	900	1000	121		
ELLATP151MB	150.0	250	780	900	151		
ELLATP181MB	180.0	320	750	750	181		
ELLATP221MB	220.0	360	700	700	221		
ELLATP331MB	330.0	550	550	600	331		
ELLATP471MB	470.0	780	470	500	471		
ELLATP681MB	680.0	1150	380	450	681		
ELLATP102MB	1000.0	1700	310	370	102		

\*1 Saturation Rated Current : This DC current which causes a 30% inductance reduction from its nominal value.

\*2 Temperature Rise Current : This indicates the value of current when temperature rise dt/t= 40 °C (at 20 °C).

## Embossed Carrier Tape Dimensions in mm (not to scale)

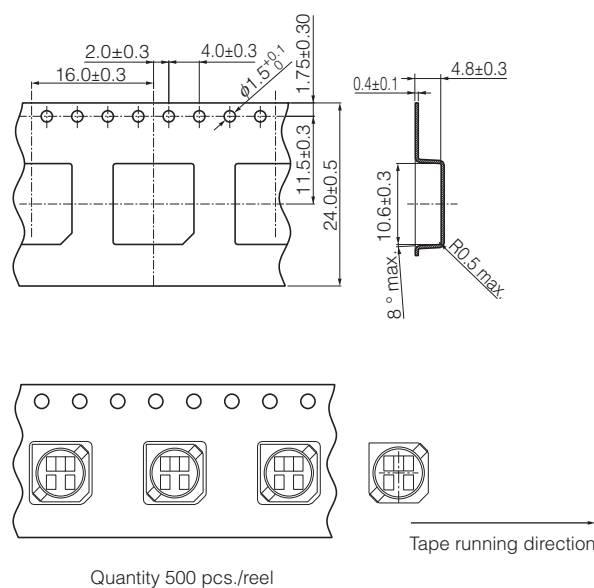

## Power Inductors / Wire Wound type

Series : **P**  
Type : **ELLCTP**

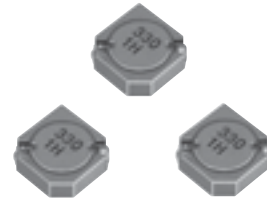

### Features

- Magnetic shielded structure
- Low DC resistance and large current capability
- Available on tape and reel for automatic insertion
- RoHS compliant

### Recommended Applications

- Audiovisual equipment, Appliance, Office automation equipment, Amusement machine, Power circuit for electric device

### Standard Packing Quantity

- 500 pcs./reel

### As for Soldering Conditions and Safety Precautions,

Please see Data Files

### Explanation of Part Numbers

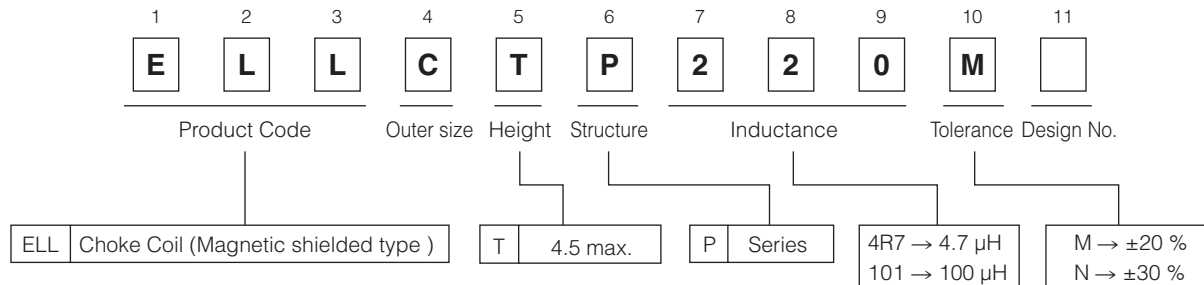

### Dimensions in mm (not to scale)

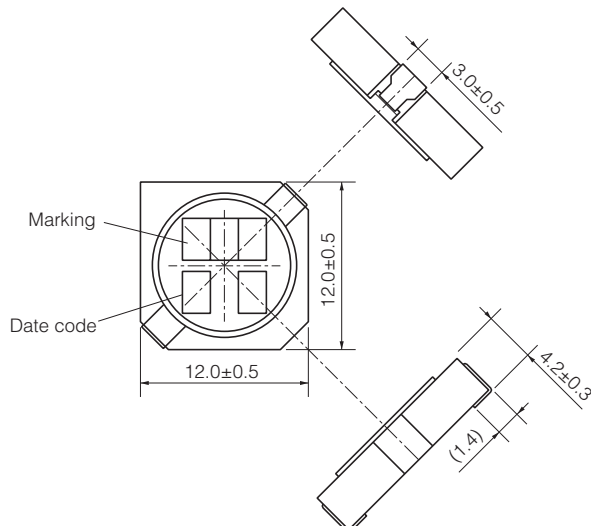

### Recommended land patterns in mm (not to scale)

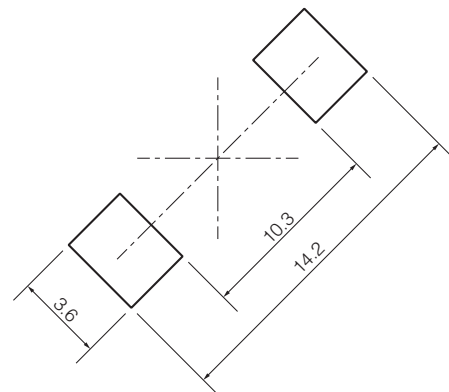

## Standard Parts

Part No.	Inductance (100 kHz)		R <sub>DC</sub> (at 20 °C)		Saturation Rated Current* <sup>1</sup> (mA max.)	Temperature Rise Current* <sup>2</sup> (mA max.)	Marking
	(μH)	Tol.	(mΩ)	Tol.			
ELLCTP1R2NB	1.2	±30 %	4.6	±30 %	11000	7000	1R2
ELLCTP2R0NB	2.0		5.6		9000	6500	2R0
ELLCTP3R3NB	3.3		7.0		7000	5800	3R3
ELLCTP4R3NB	4.3		8.5		6000	5000	4R3
ELLCTP5R6NB	5.6		10.0		5500	4500	5R6
ELLCTP6R8NB	6.8		12.5		5000	4000	6R8
ELLCTP9R1NB	9.1		15.0		4400	3800	9R1
ELLCTP150MB	15.0		±20 %		27.0	±20 %	3100
ELLCTP220MB	22.0	34.0		2600	2600		220
ELLCTP330MB	33.0	52.0		2200	2100		330
ELLCTP470MB	47.0	72.0		1900	1800		470
ELLCTP680MB	68.0	97.0		1500	1500		680
ELLCTP101MB	100.0	150.0		1200	1200		101
ELLCTP151MB	150.0	220.0		1050	1000		151
ELLCTP221MB	220.0	310.0		900	850		221
ELLCTP331MB	330.0	500.0		750	700		331
ELLCTP471MB	470.0	670.0		600	550		471
ELLCTP681MB	680.0	1070.0		550	450		681
ELLCTP102MB	1000.0	1470.0		400	400		102

\*1 Saturation Rated Current : This DC current which causes a 30% inductance reduction from its nominal value.

\*2 Temperature Rise Current : This indicates the value of current when temperature rise dt/t= 40 °C (at 20 °C).

## Embossed Carrier Tape Dimensions in mm (not to scale)

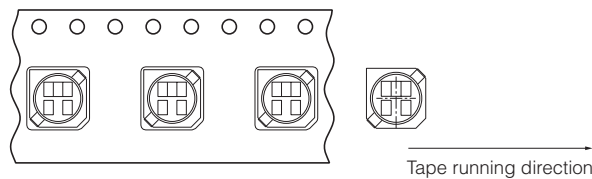
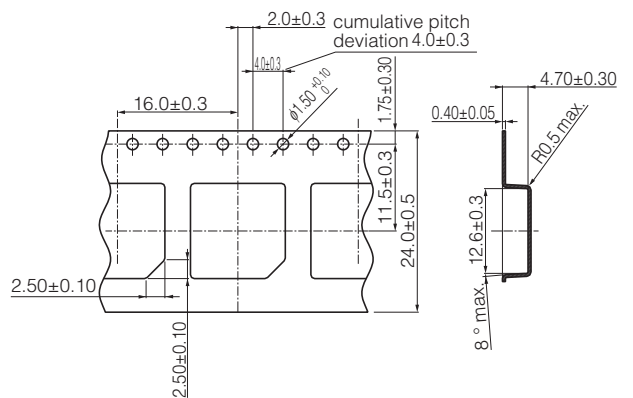

Quantity 500 pcs./reel

## Soldering Conditions

### Reflow soldering conditions

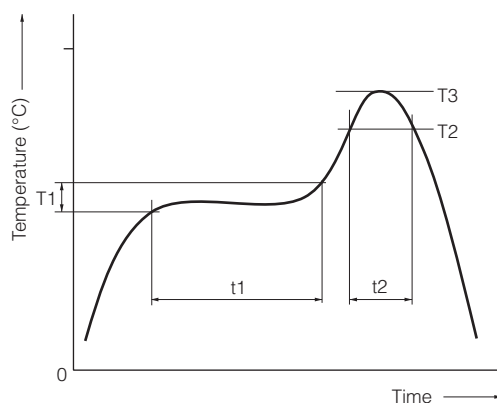

● Pb free solder recommended temperature profile

Products Item	Preheat		Soldering		Peak Temperature		Time of Reflow
	T1 [°C]	t1 [s]	T2 [°C]	t2 [s]	T3	T3 Limit	
Power Inductors / Wire Wound type	150 to 170	60 to 120	230 °C	30 max.	245 °C, 10 s	260 °C, 10 s	2 times max.

### ⚠ Safety Precautions

(Common precautions for Power Inductors / Wire Wound type)

- When using our products, no matter what sort of equipment they might be used for, be sure to make a written agreement on the specifications with us in advance. The design and specifications in this catalog are subject to change without prior notice.
  - Do not use the products beyond the specifications described in this catalog.
  - This catalog explains the quality and performance of the products as individual components. Before use, check and evaluate their operations when installed in your products.
  - Install the following systems for a failsafe design to ensure safety if these products are to be used in equipment where a defect in these products may cause the loss of human life or other significant damage, such as damage to vehicles (automobile, train, vessel), traffic lights, medical equipment, aerospace equipment, electric heating appliances, combustion/gas equipment, rotating equipment, and disaster/crime prevention equipment.
- \*Systems equipped with a protection circuit and a protection device  
\*Systems equipped with a redundant circuit or other system to prevent an unsafe status in the event of a single fault

### ⚠ Precautions for use

#### 1. Operation range and environments

- ① These products are designed and manufactured for general and standard use in general electronic equipment (e.g. AV equipment, home electric appliances, office equipment, information and communication equipment)
- ② These products are not intended for use in the following special conditions. Before using the products, carefully check the effects on their quality and performance, and determine whether or not they can be used.
  - In liquid, such as water, oil, chemicals, or organic solvent
  - In direct sunlight, outdoors, or in dust
  - In salty air or air with a high concentration of corrosive gas, such as Cl<sub>2</sub>, H<sub>2</sub>S, NH<sub>3</sub>, SO<sub>2</sub>, or NO<sub>2</sub>
  - In an environment where these products cause dew condensation

#### 2. Handling

- ① Do not bring magnets or magnetized materials close to the product. The influence of their magnetic field can change the inductance value.
- ② Do not apply strong mechanical shocks by either dropping or collision with other parts. Excessive shock can damage the part.

#### 3. Washing of board

Kindly consult the Technical department before washing of the PWB with any cleansing agent, and provide the washing condition.

#### 4. Resoldering with a soldering iron

The temperature of the tip of the soldering iron should be 360 °C or less, 4 seconds.  
And resoldering with a soldering iron should be limited to 1 time, and after that should be cooling these.

#### 5. Mounting side

External force must be less than 5.0 [N] : while mounting.

#### 6. Storage conditions

Normal temperature (–5 to 35 °C), normal humidity (85 % RH max.), shall not be exposed to direct sunlight and harmful gases and care should be taken so as not to cause dew.

#### <Package markings>

Package markings include the product number, quantity, and country of origin.  
In principle, the country of origin should be indicated in English.



## Voltage Step-up Coils

Series : **Chip**  
Type : **3KN**



ELT3KN

High inductance Voltage Step-up coil chip series for piezoelectric buzzers and DC/DC circuitry of EL panels

### Features

- Small and thin
- High inductance
- RoHS compliant

### Recommended Applications

- Piezoelectric buzzer, Booster circuit for EL backlight (Watch, Electric thermometer, Portable device)
- HAC inductor (Smartphone, Cellular phone)

### Explanation of Part Numbers

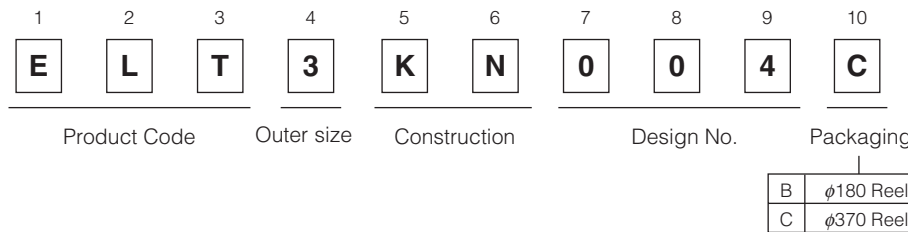

### Standard Packing Quantity

- 1,000 or 5,000 pcs./reel

### Dimensions in mm (not to scale)

- Type 3KN

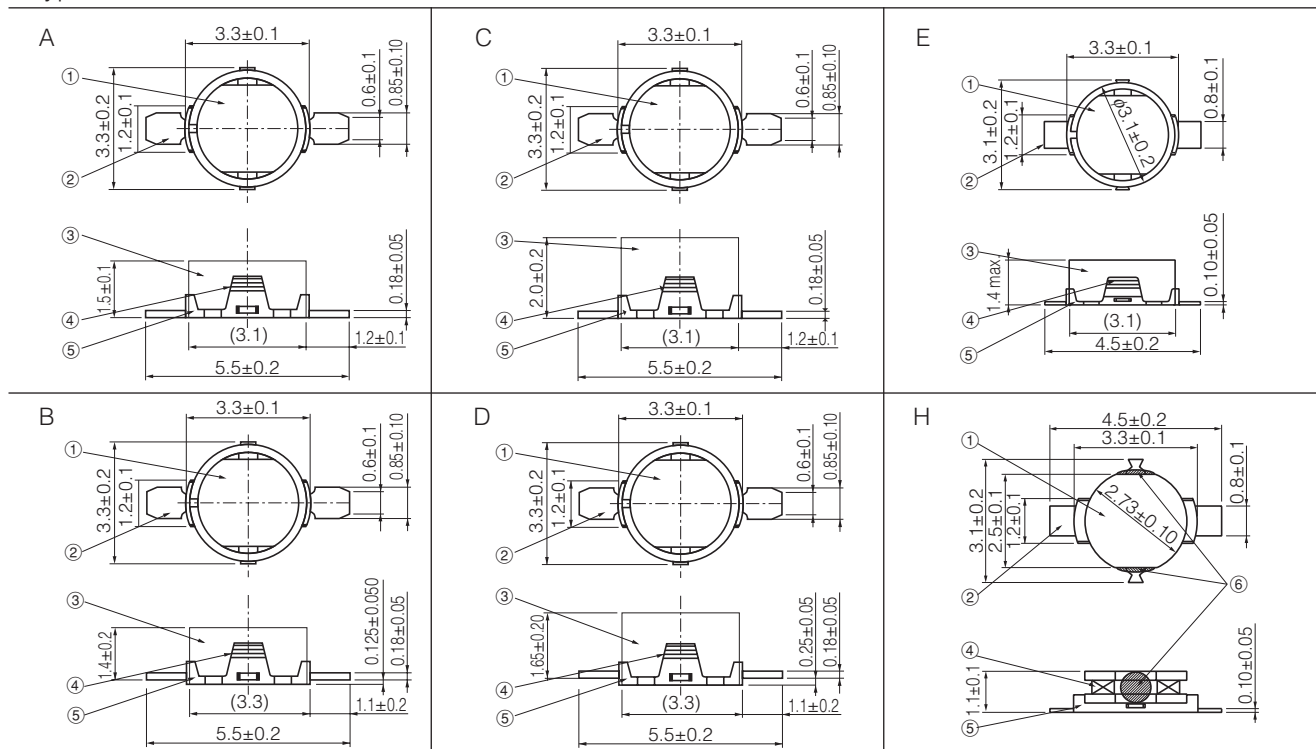

Part Name: ① Core ② Terminal ③ Ring ④ Coil ⑤ Terminal board ⑥ Adhesive

Design and specifications are each subject to change without notice. Ask factory for the current technical specifications before purchase and/or use.  
Should a safety concern arise regarding this product, please be sure to contact us immediately.

## Standard Parts

Part No.	Inductance		R. D. C		I.D.C (mA) max.	Dimensions	Magnetic Composition			
	(mH)	Tolerance(%)	( $\Omega$ )	Tolerance(%)						
ELT3KN004□	14.00	±40	125	±10	1.7	A	Permalloy ring			
ELT3KN007□	20.00		170		1.4					
ELT3KN113□	1.00	±10	34	±15	25.0		Brass ring			
ELT3KN126□	1.50		49		29.0					
ELT3KN142□	0.82		24		30.0					
ELT3KN019□	14.00	±40	125	±10	1.7		B	Permalloy ring		
ELT3KN109□	3.80	±10	115	±20	15.0	Brass ring				
ELT3KN114□	2.50		83	±15	15.0					
ELT3KN014□	30.00	±40	150	±10	1.9	C	Permalloy ring			
ELT3KN018□	35.00		235		1.9					
ELT3KN028□	50.00	±35	250	±15	1.4					
ELT3KN032□	25.00	±40	185		10.0					
ELT3KN101□	10.00	±10	285	±15	1.4			Brass ring		
ELT3KN104□	1.00		35		30.0					
ELT3KN118□	2.50		64		20.0					
ELT3KN121□	1.00		22.5		40.0					
ELT3KN122□	2.00		44		20.0					
ELT3KN123□	1.00		25		30.0					
ELT3KN124□	4.00		85		15.0					
ELT3KN127□	0.47		14		50.0					
ELT3KN128□	0.56		15		45.0					
ELT3KN129□	0.68		17		34.0					
ELT3KN130□	2.30		51		23.0					
ELT3KN131□	2.00		44		20.0					
ELT3KN020□	30.00		±30		150	±10	2.5		D	Permalloy ring
ELT3KN111□	7.50		±10		177		10.0			Brass ring
ELT3KN125□	4.00	85		15.0						
ELT3KN041□	14.00	±40	125	±10	1.7	E	Permalloy ring			
ELT3KN042□	20.00		175		1.4					
ELT3KN043□	12.00		117		1.7					
ELT3KN139□	0.68	±10	19	±15	40.0	Brass ring				
ELT3KN140□	0.82		22		30.0					
ELT3KN135□	1.10		32		30.0					
ELT3KN136□	2.00		55		20.0					
ELT3KN137□	4.00		117	±10	15.0					
ELT3KN149□	0.33		11	±15	60.0					
ELT3KN151□	0.56		17		50.0					
ELT3KN152□	0.47		14		50.0					
ELT3KN155□	1.10		38		25.0	H	Ring less			
ELT3KN162□	4.00			117	±10	15.0	E	Brass ring		
ELT3KN163□	1.10		32	±15	30.0					

“□” shows the packaging specifications.

## Packaging Methods

### ● Standard Packing Quantity

Packaging	ELT3KN	Kind of Taping
B	1,000 pcs.	Embossed Carrier Taping
C	5,000 pcs.	

### ● Reel Dimensions in mm (not to scale)

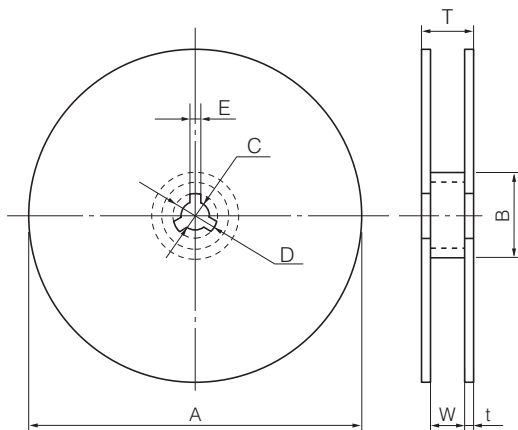

Packaging	A	B	C	D	E	W	t	T
B	180	60	13	21	2	13	1.1	15.2
C	370	60	13	21	2	14	2.0	18

### ● Embossed Carrier Tape Dimensions in mm (not to scale)

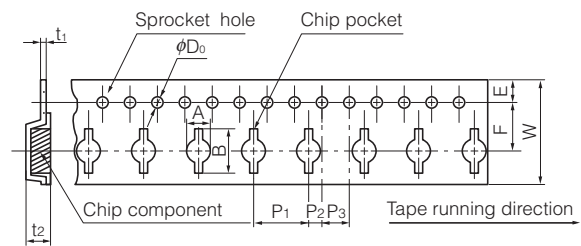

Part No.	A	B	W	F	E	P <sub>1</sub>
ELT3KN	3.7	6.4	12.0	5.5	1.75	8.0

Part No.	P <sub>2</sub>	P <sub>3</sub>	$\phi D_0$	t <sub>1</sub>	t <sub>2</sub>
ELT3KN	2.0	4.0	1.5	0.3	2.6

### ● Leader Part, Vacant Position

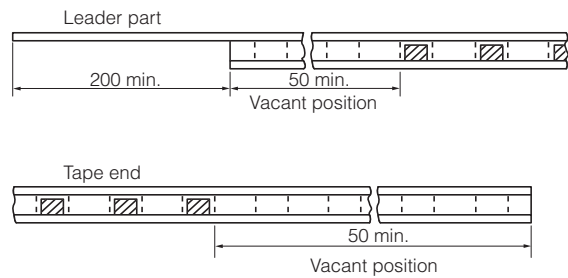

## Applied Diagram Examples

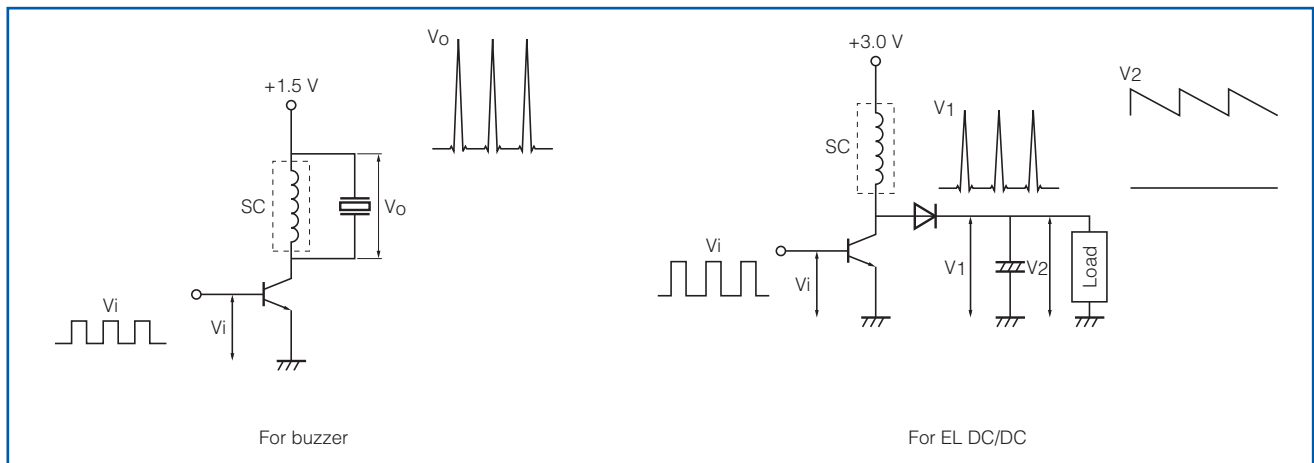

## Soldering Conditions

### Reflow soldering conditions

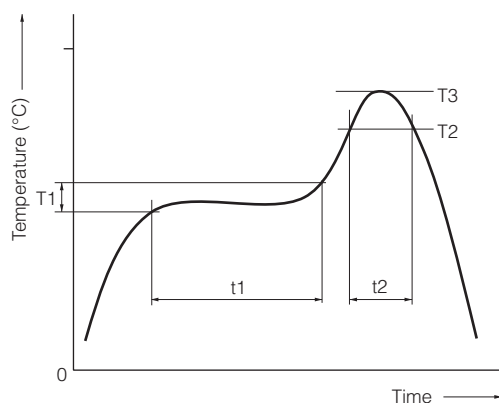

● Pb free solder recommended temperature profile

Part No.	Preheat		Soldering		Peak Temperature		Time of Reflow
	T1 [°C]	t1 [s]	T2 [°C]	t2 [s]	T3	T3 Limit	
ELT3KN	150 to 170	60 to 120	230 °C	30 max.	245 °C, 10 s	260 °C, 10 s	2 times max.

## ⚠ Safety Precautions

(Common precautions for Voltage Step-up Coils)

- When using our products, no matter what sort of equipment they might be used for, be sure to make a written agreement on the specifications with us in advance. The design and specifications in this catalog are subject to change without prior notice.
- Do not use the products beyond the specifications described in this catalog.
- This catalog explains the quality and performance of the products as individual components. Before use, check and evaluate their operations when installed in your products.
- Install the following systems for a failsafe design to ensure safety if these products are to be used in equipment where a defect in these products may cause the loss of human life or other significant damage, such as damage to vehicles (automobile, train, vessel), traffic lights, medical equipment, aerospace equipment, electric heating appliances, combustion/gas equipment, rotating equipment, and disaster/crime prevention equipment.
- \* Systems equipped with a protection circuit and a protection device
- \* Systems equipped with a redundant circuit or other system to prevent an unsafe status in the event of a single fault

## ⚠ Precautions for use

### 1. Operation range and environments

- ① These products are designed and manufactured for general and standard use in general electronic equipment (e.g. AV equipment, home electric appliances, office equipment, information and communication equipment)
- ② These products are not designed for the use in the following special conditions. Before using the products, carefully check the effects on their quality and performance, and determine whether or not they can be used.
  - In liquid, such as water, oil, chemicals, or organic solvent
  - In direct sunlight, outdoors, or in dust
  - In salty air or air with a high concentration of corrosive gas, such as Cl<sub>2</sub>, H<sub>2</sub>S, NH<sub>3</sub>, SO<sub>2</sub>, or NO<sub>2</sub>
  - In an environment where these products cause dew condensation

### 2. Handling

- ① Do not bring magnets or magnetized materials close to the product. The influence of their magnetic field can change the inductance value.
- ② Do not apply strong mechanical shocks by either dropping or collision with other parts. Excessive shock can damage the part.

### 3. Resoldering with a soldering iron

- ① Resoldering should be done within 3 seconds by soldering iron, the temperature with 350 °C or less and should be cooling down after ward. Both side of terminals shall be fixed closely to PWB. And terminals shall not be pressed in heating.

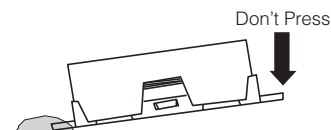

- ② The wiring tab shall not be held by sharp-edged tool.

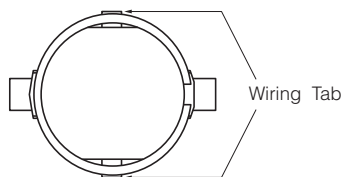

- ③ Iron shall not be put to the component itself.

### 4. Mounting side

- ① External force must be less than 4.9N while mounting.
- ② The wiring tab is expose the terminal, so please be careful when you design PWB pattern of coil circumference.

### 5. Cleaning

If you clean the inductor, please use own your ultrasonic cleaning to check specified conditions.

### 6. Storage conditions

Normal temperature (−5 to 35 °C), normal humidity (85 % RH max.), shall not be exposed to direct sunlight and harmful gases and care should be taken so as not to cause dew.

#### <Package markings>

Package markings include the product number, quantity, and country of origin. In principle, the country of origin should be indicated in English.

## Choke Coils

Series : **Pin terminal**

Type : **09D, 11D, 12D, 16B, 18B, 10E, 12E, 15E, 18E**

Pin terminal inductors featuring small size and high performance

### Features

- High -  $\mu$  and High Bm cores
- Wide inductor range
- Magnetic shield type (E Type)
- RoHS compliant

### Recommended Applications

- Appliance, Office automation equipment, Amusement machine, Power circuit for electric device





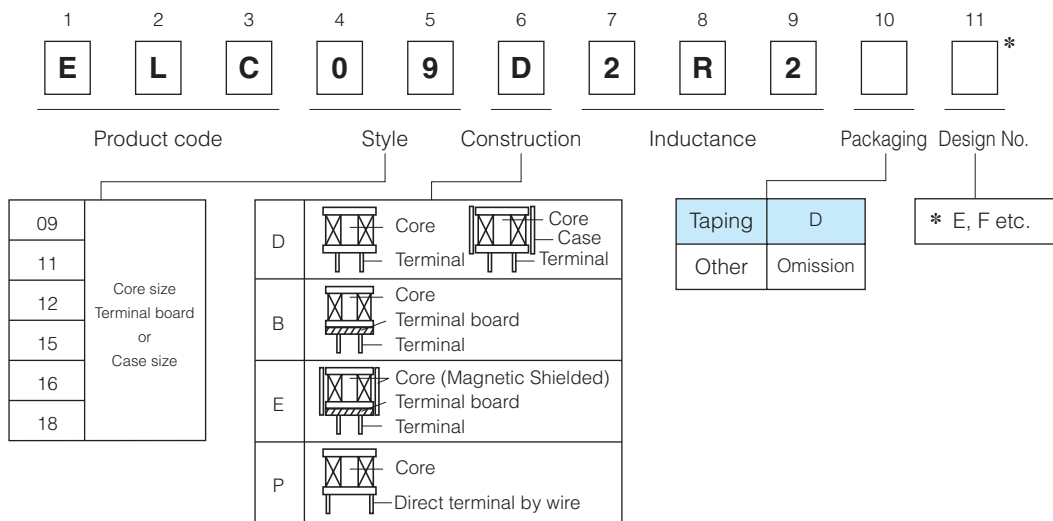

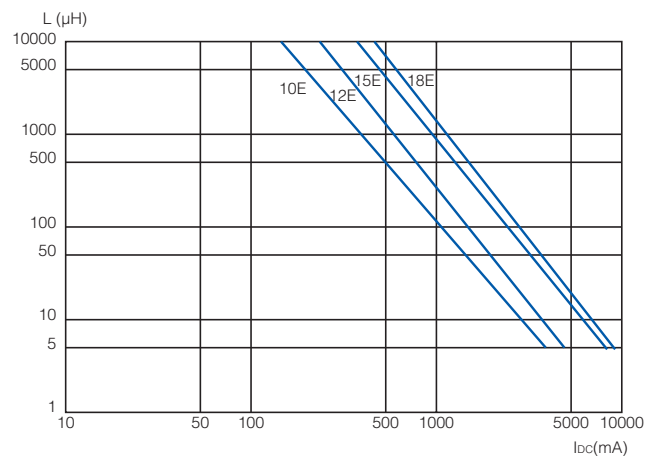
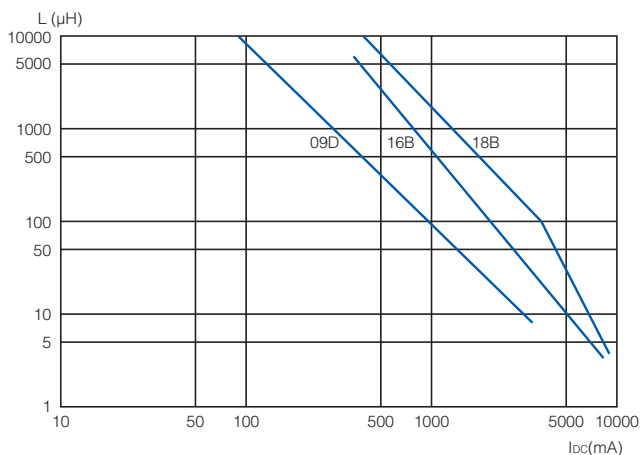

### Explanation of Part Numbers



### Available I-L Characteristics

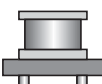

## Performance Characteristics by Series

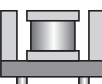
	Type	Construction	External Dimensions D×H (mm)	Inductance (μH)					Current I <sub>DC</sub> (A)	
				0.1	1.0	10	100	1000		10000
Regular	09D *		φ9.5×8.9 (with case)			2.2			10000	0.08 to 3.5
	11D *		φ11.5×13.9 (with case)			2.2			10000	0.16 to 5.3
	12D		φ12.5×16.5					100	10000	0.27 to 1.9
	16B		φ16.0×23.0			3.3			10000	0.26 to 8.5
	18B		φ20.0×27.0			3.3			10000	0.36 to 8.5
Shield	10E-L		φ10.0×13.0			3.9			8200	0.10 to 2.9
	12E-L		φ13.0×18.5			4.7			10000	0.13 to 4.4
	15E-L		φ16.0×22.0 (3 pin terminal)			5.6			10000	0.30 to 5.4
	18E-L		φ19.0×25.1 (4 pin terminal)			5.6			10000	0.33 to 5.9

\* : Taping Available

## Examples Type 09D

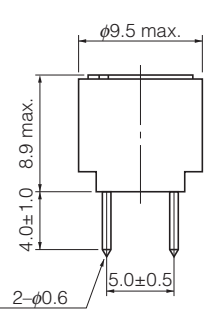
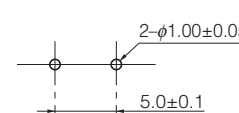
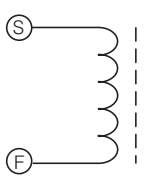
	Part No.	Inductance (μH)	Tolerance (%)	Test Freq. (kHz)	R <sub>DC</sub> (Ω) [at 20 °C] (Tol.±20 %)	I <sub>DC</sub> * [at 20 °C] (A)max.
<p>[Dimensions in mm] (not to scale)</p> 	ELC09D2R2□F	2.2	±20	10	0.012	3.50
	ELC09D2R7□F	2.7			0.013	3.30
	ELC09D3R3□F	3.3			0.015	3.20
	ELC09D3R9□F	3.9			0.016	3.10
	ELC09D4R7□F	4.7			0.018	3.00
	ELC09D5R6□F	5.6			0.019	2.90
	ELC09D6R8□F	6.8			0.021	2.80
	ELC09D8R2□F	8.2			0.024	2.60
	ELC09D100□F	10.0			0.027	2.50
	ELC09D120□F	12.0			0.031	2.30
	ELC09D150□F	15.0			0.035	2.10
	ELC09D180□F	18.0			0.038	2.00
	ELC09D220□F	22.0			0.051	1.80
	ELC09D270□F	27.0			0.058	1.60
	ELC09D330□F	33.0			0.081	1.40
	ELC09D390□F	39.0			0.087	1.30
	ELC09D470□F	47.0			0.110	1.20
	ELC09D560□F	56.0			0.130	1.10
	ELC09D680□F	68.0			0.140	1.00
	<p>Recommended PWB piercing plan</p> 	ELC09D820□F			82.0	±10
ELC09D101□F		100.0	0.200	0.82		
ELC09D121□F		120.0	0.250	0.77		
ELC09D151□F		150.0	0.320	0.74		
ELC09D181□F		180.0	0.360	0.61		
ELC09D221□F		220.0	0.410	0.58		
ELC09D271□F		270.0	0.500	0.52		
ELC09D331□F		330.0	0.650	0.49		
ELC09D391□F		390.0	0.860	0.46		
ELC09D471□F		470.0	0.980	0.39		
ELC09D561□F		560.0	1.100	0.36		
ELC09D681□F		680.0	1.400	0.34		
ELC09D821□F		820.0	1.600	0.30		
ELC09D102□F		1000.0	2.100	0.28		
ELC09D122□F		1200.0	2.400	0.23		
ELC09D152□F		1500.0	2.800	0.21		
ELC09D182□F		1800.0	3.800	0.19		
ELC09D222□F		2200.0	4.400	0.17		
ELC09D272□F		2700.0	6.100	0.16		
ELC09D332□F		3300.0	7.000	0.14		
ELC09D392□F	3900.0	8.000	0.13			
ELC09D472□F	4700.0	11.200	0.12			
ELC09D562□F	5600.0	12.600	0.11			
ELC09D682□F	6800.0	14.400	0.10			
ELC09D822□F	8200.0	16.600	0.09			
ELC09D103□F	10000.0	18.800	0.08			
<p>Connection Schematic</p> 						

\* Allowable DC Current: Smaller current value either when the inductance is -10 % or when the case temperature has risen 45 °C.

Design and specifications are each subject to change without notice. Ask factory for the current technical specifications before purchase and/or use.  
Should a safety concern arise regarding this product, please be sure to contact us immediately.

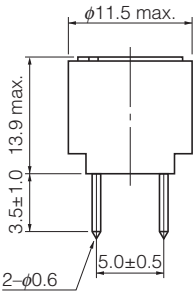
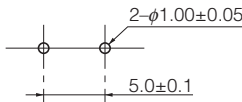
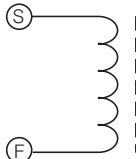

## Examples Type 11D

	Part No.	Inductance (μH)	Tolerance (%)	Test Freq. (kHz)	R <sub>DC</sub> (Ω) [at 20 °C] (Tol.±20 %)	I <sub>DC</sub> * [at 20 °C] (A)max.
<p>[Dimensions in mm] (not to scale)</p> 	ELC11D2R2□F	2.2	±20	10	0.013	5.30
	ELC11D2R7□F	2.7			0.014	5.10
	ELC11D3R3□F	3.3			0.015	4.90
	ELC11D3R9□F	3.9			0.016	4.80
	ELC11D4R7□F	4.7			0.018	4.70
	ELC11D5R6□F	5.6			0.020	4.60
	ELC11D6R8□F	6.8			0.022	4.40
	ELC11D8R2□F	8.2			0.024	3.90
	ELC11D100□F	10.0			0.029	3.50
	ELC11D120□F	12.0			0.030	3.40
	ELC11D150□F	15.0			0.033	3.30
	ELC11D180□F	18.0			0.037	3.10
	ELC11D220□F	22.0			0.040	2.80
	ELC11D270□F	27.0			0.048	2.70
	ELC11D330□F	33.0			0.051	2.60
	ELC11D390□F	39.0			0.057	2.50
	ELC11D470□F	47.0			0.063	2.30
	ELC11D560□F	56.0			0.071	2.10
	ELC11D680□F	68.0			0.082	2.00
	<p>Recommended PWB piercing plan</p> 	ELC11D820□F			82.0	±10
ELC11D101□F		100.0	0.120	1.80		
ELC11D121□F		120.0	0.160	1.60		
ELC11D151□F		150.0	0.180	1.40		
ELC11D181□F		180.0	0.200	1.30		
ELC11D221□F		220.0	0.230	1.20		
ELC11D271□F		270.0	0.320	1.10		
ELC11D331□F		330.0	0.350	1.00		
ELC11D391□F		390.0	0.400	0.95		
ELC11D471□F		470.0	0.490	0.82		
ELC11D561□F		560.0	0.620	0.73		
ELC11D681□F		680.0	0.780	0.64		
ELC11D821□F		820.0	0.870	0.62		
ELC11D102□F		1000.0	1.100	0.57		
ELC11D122□F		1200.0	1.200	0.52		
ELC11D152□F		1500.0	1.700	0.43		
ELC11D182□F		1800.0	2.000	0.40		
ELC11D222□F		2200.0	2.300	0.38		
ELC11D272□F		2700.0	2.800	0.34		
<p>Connection Schematic</p> 		ELC11D332□F	3300.0			
	ELC11D392□F	3900.0			4.500	0.29
	ELC11D472□F	4700.0			5.200	0.26
	ELC11D562□F	5600.0			6.900	0.23
	ELC11D682□F	6800.0			7.800	0.21
	ELC11D822□F	8200.0			10.600	0.18
	ELC11D103□F	10000.0			11.800	0.16

\* Allowable DC Current: Smaller current value either when the inductance is -10 % or when the case temperature has risen 45 °C.

Design and specifications are each subject to change without notice. Ask factory for the current technical specifications before purchase and/or use. Should a safety concern arise regarding this product, please be sure to contact us immediately.

## Examples Type 12D

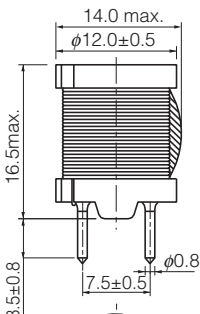
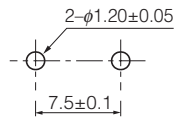
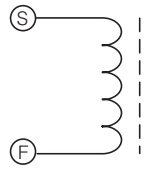
	Part No.	Inductance (μH)	Tolerance (%)	Test Freq. (kHz)	R <sub>DC</sub> (Ω) [at 20 °C] (Tol. ±20 %)	I <sub>DC</sub> * [at 20 °C] (A)max.
<p>[Dimensions in mm] (not to scale)</p>  <p>Recommended PWB piercing plan</p>  <p>Connection Schematic</p> 	ELC12D101E	100	±10	10	0.150	1.90
	ELC12D121E	120			0.170	1.78
	ELC12D151E	150			0.190	1.67
	ELC12D181E	180			0.210	1.58
	ELC12D221E	220			0.230	1.55
	ELC12D271E	270			0.270	1.44
	ELC12D331E	330			0.300	1.34
	ELC12D391E	390			0.330	1.32
	ELC12D471E	470			0.380	1.25
	ELC12D561E	560			0.420	1.15
	ELC12D681E	680			0.460	0.98
	ELC12D821E	820			0.650	0.94
	ELC12D102E	1000			0.720	0.87
	ELC12D122E	1200			0.830	0.86
	ELC12D152E	1500			1.270	0.64
	ELC12D182E	1800			1.330	0.63
	ELC12D222E	2200			1.500	0.60
	ELC12D272E	2700			1.890	0.54
	ELC12D332E	3300			2.370	0.48
	ELC12D392E	3900			2.830	0.45
ELC12D472E	4700	3.190	0.41			
ELC12D562E	5600	4.080	0.34			
ELC12D682E	6800	5.740	0.29			
ELC12D822E	8200	6.340	0.28			
ELC12D103E	10000	7.200	0.27			

\* Allowable DC Current: Smaller current value either when the inductance is -10 % or when the case temperature has risen 45 °C.

## Examples Type 16B

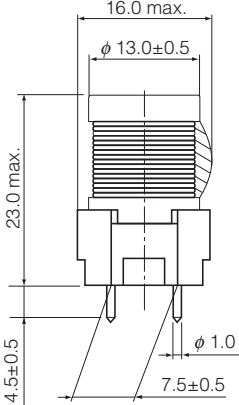
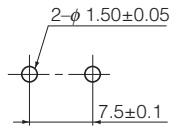
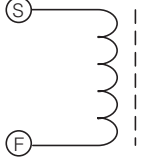
	Part No.	Inductance (μH)	Tolerance (%)	Test Freq. (kHz)	R <sub>DC</sub> (Ω) [at 20 °C] (Tol.±30 %)** (Tol.±20 %)	I <sub>DC</sub> * [at 20 °C] (A)max.	
<p>[Dimensions in mm] (not to scale)</p>  <p>Recommended PWB piercing plan</p>  <p>Connection Schematic</p> 	ELC16B3R3L	3.3	±25	10	0.012**	8.50	
	ELC16B3R9L	3.9			±20	0.013**	8.00
	ELC16B4R7L	4.7				0.015**	7.80
	ELC16B5R6L	5.6	0.016**			7.40	
	ELC16B6R8L	6.8	0.018			6.70	
	ELC16B8R2L	8.2	0.019			6.10	
	ELC16B100L	10.0	±10			0.022	5.60
	ELC16B120L	12.0			0.023	5.50	
	ELC16B150L	15.0			0.026	5.40	
	ELC16B180L	18.0			0.028	5.10	
	ELC16B220L	22.0			0.031	4.60	
	ELC16B270L	27.0			0.034	4.30	
	ELC16B330L	33.0			0.039	4.00	
	ELC16B390L	39.0			0.042	3.90	
	ELC16B470L	47.0			0.045	3.80	
	ELC16B560L	56.0			0.051	3.40	
	ELC16B680L	68.0			0.057	3.20	
	ELC16B820L	82.0			0.064	3.00	
	ELC16B101L	100.0			0.072	2.60	
	ELC16B121L	120.0			0.080	2.50	
	ELC16B151L	150.0			0.103	2.20	
	ELC16B181L	180.0			0.115	2.10	
	ELC16B221L	220.0			0.130	1.90	
	ELC16B271L	270.0			0.170	1.60	
	ELC16B331L	330.0	0.200		1.50		
	ELC16B391L	390.0	0.250		1.30		
	ELC16B471L	470.0	0.280		1.20		
	ELC16B561L	560.0	0.380		1.10		
	ELC16B681L	680.0	0.430		1.00		
	ELC16B821L	820.0	0.580		0.88		
	ELC16B102L	1000.0	0.660		0.85		
	ELC16B122L	1200.0	0.740		0.82		
	ELC16B152L	1500.0	0.870		0.74		
	ELC16B182L	1800.0	1.220		0.60		
ELC16B222L	2200.0	1.380	0.57				
ELC16B272L	2700.0	1.570	0.54				
ELC16B332L	3300.0	2.000	0.47				
ELC16B392L	3900.0	2.400	0.42				
ELC16B472L	4700.0	3.300	0.36				
ELC16B562L	5600.0	3.700	0.34				
ELC16B682L	6800.0	4.200	0.32				
ELC16B822L	8200.0	5.600	0.28				
ELC16B103L	10000.0	6.400	0.26				

\* Allowable DC Current: Smaller current value either when the inductance is -10 % or when the case temperature has risen 45 °C.

## Examples Type 18B

	Part No.	Inductance (μH)	Tolerance (%)	Test Freq. (kHz)	R <sub>DC</sub> (Ω) [at 20 °C] (Tol.±20 %)	I <sub>DC</sub> * [at 20 °C] (A)max.
<p>[Dimensions in mm] (not to scale)</p> <p>Recommended PWB piercing plan</p> <p>Connection Schematic</p>	ELC18B3R3L	3.3	±20	10	0.010	8.50
	ELC18B3R9L	3.9			0.011	8.00
	ELC18B4R7L	4.7			0.012	7.80
	ELC18B5R6L	5.6			0.013	7.40
	ELC18B6R8L	6.8			0.015	6.80
	ELC18B8R2L	8.2			0.016	6.60
	ELC18B100L	10.0			0.017	6.50
	ELC18B120L	12.0			0.018	6.00
	ELC18B150L	15.0			0.021	5.90
	ELC18B180L	18.0			0.022	5.60
	ELC18B220L	22.0	0.025		5.40	
	ELC18B270L	27.0	0.028		4.80	
	ELC18B330L	33.0	0.030		4.60	
	ELC18B390L	39.0	0.033		4.40	
	ELC18B470L	47.0	0.037		4.30	
	ELC18B560L	56.0	0.040		4.20	
	ELC18B680L	68.0	0.046		4.00	
	ELC18B820L	82.0	0.051		3.70	
	ELC18B101L	100.0	0.057		3.20	
	ELC18B121L	120.0	0.065		3.00	
	ELC18B151L	150.0	0.072		2.70	
	ELC18B181L	180.0	0.082		2.60	
	ELC18B221L	220.0	0.090		2.40	
	ELC18B271L	270.0	0.110		2.20	
	ELC18B331L	330.0	0.130		1.90	
	ELC18B391L	390.0	0.150		1.80	
	ELC18B471L	470.0	0.210		1.60	
	ELC18B561L	560.0	0.230		1.50	
	ELC18B681L	680.0	0.260		1.40	
	ELC18B821L	820.0	0.340		1.30	
	ELC18B102L	1000.0	0.390		1.10	
	ELC18B122L	1200.0	0.440		1.00	
	ELC18B152L	1500.0	0.580		0.85	
ELC18B182L	1800.0	0.650	0.84			
ELC18B222L	2200.0	0.880	0.75			
ELC18B272L	2700.0	1.200	0.68			
ELC18B332L	3300.0	1.400	0.60			
ELC18B392L	3900.0	1.500	0.57			
ELC18B472L	4700.0	1.700	0.55			
ELC18B562L	5600.0	2.200	0.46			
ELC18B682L	6800.0	2.800	0.45			
ELC18B822L	8200.0	3.100	0.41			
ELC18B103L	10000.0	3.900	0.36			
			±10			

\* Allowable DC Current: Smaller current value either when the inductance is -10 % or when the case temperature has risen 45 °C.

## Examples Type 10E-L

	Part No.	Inductance (μH)	Tolerance (%)	Test Freq. (kHz)	R <sub>DC</sub> (Ω) [at 20 °C] (Tol.±20 %)	I <sub>DC</sub> * [at 20 °C] (A)max.
[Dimensions in mm] (not to scale)	ELC10E3R9L	3.9	±20	10	0.024	2.90
	ELC10E4R7L	4.7			0.027	2.80
	ELC10E5R6L	5.6			0.030	2.70
	ELC10E6R8L	6.8			0.032	2.60
	ELC10E8R2L	8.2			0.035	2.50
	ELC10E100L	10.0			0.038	2.40
	ELC10E120L	12.0			0.040	2.30
	ELC10E150L	15.0			0.046	2.20
	ELC10E180L	18.0			0.049	2.10
	Recommended PWB piercing plan	ELC10E220L			22.0	±15
ELC10E270L		27.0	0.062		1.90	
ELC10E330L		33.0	0.068		1.80	
ELC10E390L		39.0	0.074		1.70	
ELC10E470L		47.0	0.098		1.50	
ELC10E560L		56.0	0.120		1.30	
ELC10E680L		68.0	0.150		1.20	
ELC10E820L		82.0	0.190		1.00	
ELC10E101L		100.0	0.210		0.96	
ELC10E121L		120.0	0.240		0.92	
Connection Schematic	ELC10E151L	150.0	±10		0.260	0.83
	ELC10E181L	180.0			0.290	0.74
	ELC10E221L	220.0			0.410	0.64
	ELC10E271L	270.0			0.590	0.54
	ELC10E331L	330.0			0.660	0.52
	ELC10E391L	390.0			0.720	0.50
	ELC10E471L	470.0			0.800	0.45
	ELC10E561L	560.0			1.100	0.41
	ELC10E681L	680.0			1.200	0.37
	ELC10E821L	820.0			1.600	0.33
	ELC10E102L	1000.0	1.800		0.31	
	ELC10E122L	1200.0	2.000	0.29		
	ELC10E152L	1500.0	2.800	0.26		
	ELC10E182L	1800.0	3.200	0.23		
	ELC10E222L	2200.0	3.600	0.20		
	ELC10E272L	2700.0	5.200	0.18		
	ELC10E332L	3300.0	5.900	0.17		
	ELC10E392L	3900.0	6.500	0.16		
	ELC10E472L	4700.0	9.600	0.14		
	ELC10E562L	5600.0	10.800	0.12		
	ELC10E682L	6800.0	11.900	0.11		
	ELC10E822L	8200.0	13.200	0.10		

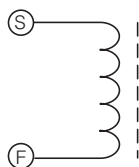
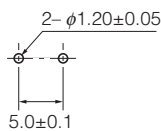
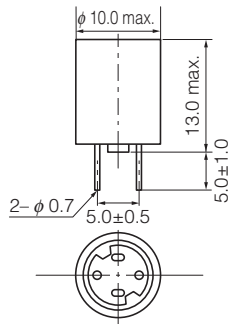

\* Allowable DC Current: Smaller current value either when the inductance is -10 % or when the case temperature has risen 45 °C.

## Examples Type 12E-L

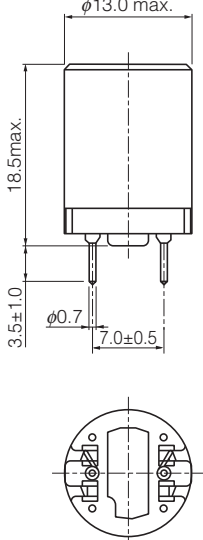
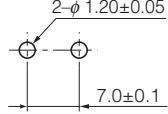
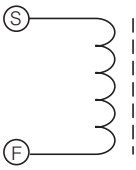
	Part No.	Inductance (μH)	Tolerance (%)	Test Freq. (kHz)	R <sub>DC</sub> (Ω) [at 20 °C] (Tol. ±20 %)	I <sub>DC</sub> * [at 20 °C] (A)max.
<p>[Dimensions in mm] (not to scale)</p>  <p>Recommended PWB piercing plan</p>  <p>Connection Schematic</p> 	ELC12E4R7L	4.7	±25	10	0.014	4.40
	ELC12E5R6L	5.6			0.016	4.10
	ELC12E6R8L	6.8			0.018	3.90
	ELC12E8R2L	8.2			0.020	3.70
	ELC12E100L	10.0	±20		0.023	3.50
	ELC12E120L	12.0			0.024	3.30
	ELC12E150L	15.0			0.028	3.20
	ELC12E180L	18.0			0.030	3.10
	ELC12E220L	22.0	±10		0.033	2.80
	ELC12E270L	27.0			0.037	2.50
	ELC12E330L	33.0			0.041	2.40
	ELC12E390L	39.0			0.044	2.20
	ELC12E470L	47.0			0.048	2.00
	ELC12E560L	56.0			0.053	1.80
	ELC12E680L	68.0			0.073	1.70
	ELC12E820L	82.0			0.098	1.40
	ELC12E101L	100.0			0.140	1.30
	ELC12E121L	120.0			0.160	1.20
	ELC12E151L	150.0	0.180		1.10	
	ELC12E181L	180.0	0.200		1.00	
	ELC12E221L	220.0	0.220		0.91	
	ELC12E271L	270.0	0.320		0.83	
	ELC12E331L	330.0	0.360		0.79	
	ELC12E391L	390.0	0.400		0.70	
	ELC12E471L	470.0	0.440		0.64	
	ELC12E561L	560.0	0.490		0.57	
	ELC12E681L	680.0	0.610		0.52	
	ELC12E821L	820.0	0.760		0.47	
	ELC12E102L	1000.0	1.100		0.43	
	ELC12E122L	1200.0	1.200		0.40	
	ELC12E152L	1500.0	1.400		0.36	
	ELC12E182L	1800.0	1.900		0.32	
	ELC12E222L	2200.0	2.500		0.30	
ELC12E272L	2700.0	3.500	0.26			
ELC12E332L	3300.0	3.900	0.24			
ELC12E392L	3900.0	4.300	0.22			
ELC12E472L	4700.0	6.000	0.20			
ELC12E562L	5600.0	6.600	0.17			
ELC12E682L	6800.0	9.900	0.15			
ELC12E822L	8200.0	10.900	0.14			
ELC12E103L	10000.0	12.200	0.13			

\* Allowable DC Current: Smaller current value either when the inductance is -10 % or when the case temperature has risen 45 °C.

## Examples Type 15E-L

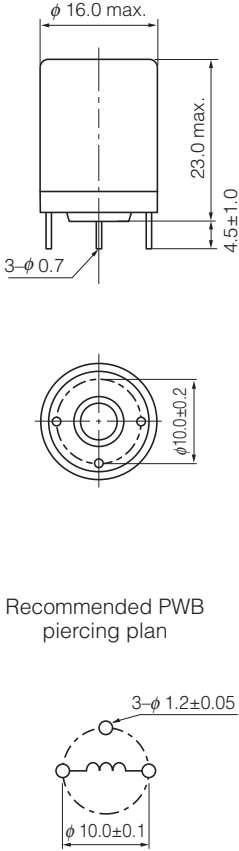
	Part No.	Inductance (μH)	Tolerance (%)	Test Freq. (kHz)	R <sub>DC</sub> (Ω) [at 20 °C] (Tol. ±20 %)	I <sub>DC</sub> * [at 20 °C] (A)max.
<p>[Dimensions in mm] (not to scale)</p>  <p>Recommended PWB piercing plan</p>	ELC15E5R6L	5.6	±20	10	0.012	6.80
	ELC15E6R8L	6.8			0.013	6.30
	ELC15E8R2L	8.2			0.016	5.80
	ELC15E100L	10			0.018	5.40
	ELC15E120L	12			0.019	5.10
	ELC15E150L	15			0.022	4.70
	ELC15E180L	18			0.024	4.50
	ELC15E220L	22			0.027	4.30
	ELC15E270L	27			0.029	4.10
	ELC15E330L	33			0.032	4.00
	ELC15E390L	39			0.033	3.80
	ELC15E470L	47			0.037	3.70
	ELC15E560L	56			0.039	3.60
	ELC15E680L	68			0.045	3.50
	ELC15E820L	82	0.048		3.20	
	ELC15E101L	100	0.053		3.00	
	ELC15E121L	120	0.059		2.60	
	ELC15E151L	150	0.077		2.40	
	ELC15E181L	180	0.100		2.30	
	ELC15E221L	220	0.140		2.00	
	ELC15E271L	270	0.150		1.70	
	ELC15E331L	330	0.170		1.60	
	ELC15E391L	390	0.190		1.50	
	ELC15E471L	470	0.210		1.30	
	ELC15E561L	560	0.280		1.20	
	ELC15E681L	680	0.310		1.10	
	ELC15E821L	820	0.440		1.00	
	ELC15E102L	1000	0.490		0.95	
	ELC15E122L	1200	0.540		0.85	
	ELC15E152L	1500	0.710		0.80	
	ELC15E182L	1800	0.870		0.75	
	ELC15E222L	2200	1.100		0.63	
	ELC15E272L	2700	1.400		0.60	
	ELC15E332L	3300	1.600		0.53	
ELC15E392L	3900	1.700	0.47			
ELC15E472L	4700	2.400	0.43			
ELC15E562L	5600	2.600	0.39			
ELC15E682L	6800	2.900	0.36			
ELC15E822L	8200	3.500	0.34			
ELC15E103L	10000	4.600	0.30			
			±10			

\* Allowable DC Current: Smaller current value either when the inductance is -10 % or when the case temperature has risen 45 °C.

## Examples Type 18E-L

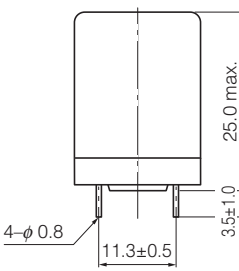
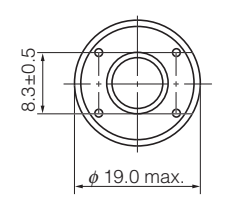
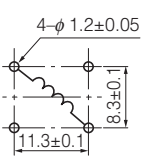
	Part No.	Inductance (μH)	Tolerance (%)	Test Freq. (kHz)	R <sub>DC</sub> (Ω) [at 20 °C] (Tol. ±20 %)	I <sub>DC</sub> * [at 20 °C] (A)max.
<p>[Dimensions in mm] (not to scale)</p>   <p>Recommended PWB piercing plan</p>  <p>(Top View)</p>	ELC18E5R6L	5.6	±20	10	0.011	6.70
	ELC18E6R8L	6.8			0.013	6.50
	ELC18E8R2L	8.2			0.013	6.20
	ELC18E100L	10			0.014	5.90
	ELC18E120L	12			0.016	5.60
	ELC18E150L	15			0.017	5.40
	ELC18E180L	18			0.019	5.20
	ELC18E220L	22			0.022	5.00
	ELC18E270L	27			0.023	4.80
	ELC18E330L	33			0.026	4.60
	ELC18E390L	39	0.028		4.50	
	ELC18E470L	47	0.030		4.10	
	ELC18E560L	56	0.031		3.80	
	ELC18E680L	68	0.036		3.60	
	ELC18E820L	82	0.040		3.50	
	ELC18E101L	100	0.044		3.00	
	ELC18E121L	120	0.047		2.80	
	ELC18E151L	150	0.061		2.60	
	ELC18E181L	180	0.067		2.50	
	ELC18E221L	220	0.076		2.10	
	ELC18E271L	270	0.083		2.00	
	ELC18E331L	330	0.110		1.90	
	ELC18E391L	390	0.120		1.80	
	ELC18E471L	470	0.150		1.50	
	ELC18E561L	560	0.170		1.40	
	ELC18E681L	680	0.190		1.20	
	ELC18E821L	820	0.210		1.10	
	ELC18E102L	1000	0.280		1.00	
	ELC18E122L	1200	0.360		0.95	
	ELC18E152L	1500	0.510		0.90	
	ELC18E182L	1800	0.570		0.80	
	ELC18E222L	2200	0.630		0.73	
	ELC18E272L	2700	0.890		0.65	
	ELC18E332L	3300	1.000		0.60	
ELC18E392L	3900	1.100	0.50			
ELC18E472L	4700	1.400	0.48			
ELC18E562L	5600	1.600	0.46			
ELC18E682L	6800	2.200	0.39			
ELC18E822L	8200	2.400	0.35			
ELC18E103L	10000	2.700	0.33			

\* Allowable DC Current: Smaller current value either when the inductance is -10 % or when the case temperature has risen 45 °C.



**Tape Dimensions in mm for Type 09D (not to scale)**

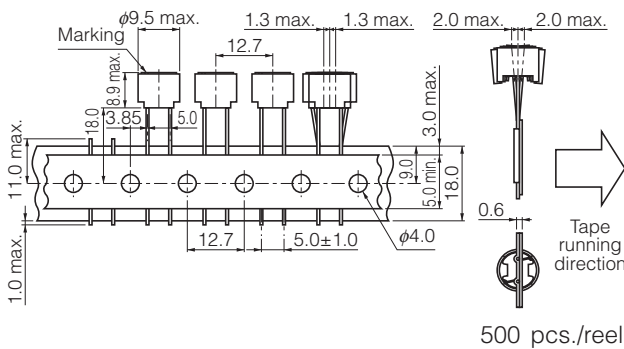

**Tape Dimensions in mm for Type 11D (not to scale)**

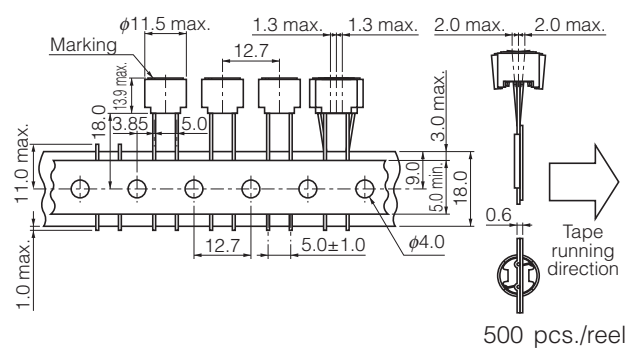

## ⚠ Safety Precautions

- When using our products, no matter what sort of equipment they might be used for, be sure to make a written agreement on the specifications with us in advance. The design and specifications in this catalog are subject to change without prior notice.
- Do not use the products beyond the specifications described in this catalog.
- This catalog explains the quality and performance of the products as individual components. Before use, check and evaluate their operations when installed in your products.
- Install the following systems for a failsafe design to ensure safety if these products are to be used in equipment where a defect in these products may cause the loss of human life or other significant damage, such as damage to vehicles (automobile, train, vessel), traffic lights, medical equipment, aerospace equipment, electric heating appliances, combustion/gas equipment, rotating equipment, and disaster/crime prevention equipment.
- \* Systems equipped with a protection circuit and a protection device
- \* Systems equipped with a redundant circuit or other system to prevent an unsafe status in the event of a single fault

## ⚠ Precautions for use

### 1. Rated current

The rated current is defined as the smaller value of either the current value when the inductance drops 10 % down from its initial point, or when the average temperature of coil interior rises 45 °C up on power source. Do not operate these coils beyond the specified rated current.

### 2. Mounting

- ① Cores may be damaged when excessive force or shock is applied.  
Do not use products which may have been dropped.
- ② Be careful not to make contact with other parts and consider possible interaction between coils due to magnetic interference.
- ③ Be careful of being too close to heat-radiating parts (high temperature).
- ④ Do not bend the pin-terminals during assembly.  
The pin-terminals must connect correctly.  
Do not apply them a shock to avoid causing an open or short circuit condition.
- ⑤ The float on PWB must not be after mounting.

### 3. Soldering

- ① Use flux which will not effect copper wire. (Be sure to use proper amounts of chloride, pH and other solvents)
- ② When using a soldering iron, wait at least 3 minutes before attempting to re-solder.

### 4. Storage

- ① Avoid high temperatures, high moisture, gases and magnetic fields.
- ② For long term storage of more than 1 year, use the products only after inspecting their outer structure.  
(Look for possible rusting of the core and oxidation of the lead wire, which would affect its solderability.)

## <Package markings>

Package markings include the product number, quantity, and country of origin. In principle, the country of origin should be indicated in English.

## CAUTION AND WARNING

1. The electronic components contained in this catalog are designed and produced for use in home electric appliances, office equipment, information equipment, communications equipment, and other general purpose electronic devices.  
Before use of any of these components for equipment that requires a high degree of safety, such as medical instruments, aerospace equipment, disaster-prevention equipment, security equipment, vehicles (automobile, train, vessel), please be sure to contact our sales representative.
2. When applying one of these components for equipment requiring a high degree of safety, no matter what sort of application it might be, be sure to install a protective circuit or redundancy arrangement to enhance the safety of your equipment. In addition, please carry out the safety test on your own responsibility.
3. When using our products, no matter what sort of equipment they might be used for, be sure to make a written agreement on the specifications with us in advance.
4. Technical information contained in this catalog is intended to convey examples of typical performances and/or applications and is not intended to make any warranty with respect to the intellectual property rights or any other related rights of our company or any third parties nor grant any license under such rights.
5. In order to export products in this catalog, the exporter may be subject to the export license requirement under the Foreign Exchange and Foreign Trade Law of Japan.
6. No ozone-depleting substances (ODSs) under the Montreal Protocol are used in the manufacturing processes of Automotive & Industrial Systems Company, Panasonic Corporation.

● Please contact

● Factory

**Device Solutions Business Division**  
**Automotive & Industrial Systems Company**  
**Panasonic Corporation**  
1006 Kadoma, Kadoma City, Osaka 571-8506,  
JAPAN

The information in this catalog is valid as of September, 2016.