

### SMF Series



#### Agency Approvals

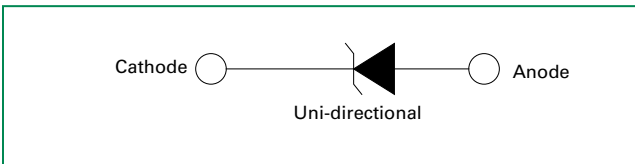
| AGENCY | AGENCY FILE NUMBER |
|--------|--------------------|
|        | E230531            |

#### Maximum Ratings and Thermal Characteristics (T<sub>A</sub> = 25°C unless otherwise noted)

| Parameter   | Symbol           | Value      | Unit |
|---|------------------|------------|------|
| Peak Pulse Power Dissipation at T <sub>A</sub> = 25°C by 10/1000µs (Note 1) | P <sub>PPM</sub> | 200        | W    |
| Thermal Resistance Junction- to-Ambient                                     | R <sub>θJA</sub> | 220        | °C/W |
| Thermal Resistance Junction- to-Lead  | R <sub>θJL</sub> | 100        | °C/W |
| Operating Temperature Range   | T <sub>J</sub>   | -65 to 150 | °C   |
| Storage Temperature Range   | T <sub>STG</sub> | -65 to 175 | °C   |

**Notes:**  
1. Non-repetitive current pulse, per Fig. 4 and derated above T<sub>J</sub> (initial) = 25°C per Fig. 3.

#### Functional Diagram



#### Description

The SMF series is designed specifically to protect sensitive electronic equipment from voltage transients induced by lightning and other transient voltage events.

SMF package is 50% smaller in footprint when compare to SMA package and delivering one of the low height profiles (1.1mm) in the industry.

#### Features

- 200W peak pulsepower capability at 10/1000µs waveform, repetition rate (duty cycle): 0.01 %
- Compatible with industrial standard package SOD-123FL
- Low profile: maximum height of 1.1mm.
- Low inductance, excellent clamping capability
- For surface mounted applications to optimize board space
- High temperature to reflow soldering guaranteed: 260°C/40sec
- Typical failure mode is short from over-specified voltage or current
- Whisker test is conducted based on JEDEC JESD201A per its table 4a and 4c
- IEC-61000-4-2 ESD 30kV(Air), 30kV (Contact)
- ESD protection of data lines in accordance with IEC 61000-4-2
- EFT protection of data lines in accordance with IEC 61000-4-4
- Fast response time: typically less than 1.0ns from 0 Volts to V<sub>BR</sub> min
- Glass passivated junction
- Built-in strain relief
- Plastic package is flammability rated V-0 per Underwriters Laboratories
- Meet MSL level1, per J-STD-020, LF maximum peak of 260°C
- Matte tin lead-free plated
- Halogen-free and RoHS compliant
- Pb-free E3 means 2nd level interconnect is Pb-free and the terminal finish material is tin(Sn) (IPC/ JEDEC J-STD-609A.01)

#### Applications

SMF devices are ideal for the protection of I/O interfaces, V<sub>CC</sub> bus and other vulnerable circuit used in cellular phones, portable devices, business machines, power supplies and other consumer applications.

#### Additional Information



Datasheet



Resources



Samples

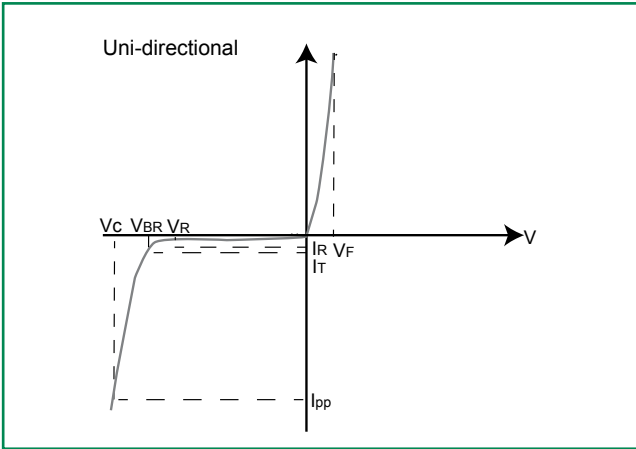
### Electrical Characteristics ( $T_A=25^\circ\text{C}$ unless otherwise noted)

| Part Number | Marking Code | Breakdown Voltage $V_{BR}$ (Volts) @ $I_T$ |        | Test Current $I_T$ (mA) | Reverse Stand off Voltage $V_R$ (V) | Maximum Reverse Leakage @ $V_R$ $I_R$ ( $\mu\text{A}$ ) | Maximum Peak Pulse Current $I_{PP}$ (A) | Maximum Clamping Voltage @ $I_{PP}$ $V_C$ (V) | Agency Approval |
|-------------|--------------|--|--------|-------------------------|-------------------------------------|---|---|---|-----------------|
|             |              | MIN  | MAX    |                         |                                     |   |   |   |                 |
| SMF5.0A     | AE           | 6.40                                       | 7.00   | 10                      | 5.0                                 | 400   | 21.7                                    | 9.2   | X               |
| SMF6.0A     | AG           | 6.67                                       | 7.37   | 10                      | 6.0                                 | 400   | 19.4                                    | 10.3  | X               |
| SMF6.5A     | AK           | 7.22                                       | 7.98   | 10                      | 6.5                                 | 250   | 17.9                                    | 11.2  | X               |
| SMF7.0A     | AM           | 7.78                                       | 8.60   | 10                      | 7.0                                 | 100   | 16.7                                    | 12.0  | X               |
| SMF7.5A     | AP           | 8.33                                       | 9.21   | 1                       | 7.5                                 | 50  | 15.5                                    | 12.9  | X               |
| SMF8.0A     | AR           | 8.89                                       | 9.83   | 1                       | 8.0                                 | 25  | 14.7                                    | 13.6  | X               |
| SMF8.5A     | AT           | 9.44                                       | 10.40  | 1                       | 8.5                                 | 10  | 13.9                                    | 14.4  | X               |
| SMF9.0A     | AV           | 10.00                                      | 11.10  | 1                       | 9.0                                 | 5   | 13.0                                    | 15.4  | X               |
| SMF10A      | AX           | 11.10                                      | 12.30  | 1                       | 10                                  | 2.5   | 11.8                                    | 17.0  | X               |
| SMF11A      | AZ           | 12.20                                      | 13.50  | 1                       | 11                                  | 2.5   | 11.0                                    | 18.2  | X               |
| SMF12A      | BE           | 13.30                                      | 14.70  | 1                       | 12                                  | 2.5   | 10.1                                    | 19.9  | X               |
| SMF13A      | BG           | 14.40                                      | 15.90  | 1                       | 13                                  | 1.0   | 9.3                                     | 21.5  | X               |
| SMF14A      | BK           | 15.60                                      | 17.20  | 1                       | 14                                  | 1.0   | 8.6                                     | 23.2  | X               |
| SMF15A      | BM           | 16.70                                      | 18.50  | 1                       | 15                                  | 1.0   | 8.2                                     | 24.4  | X               |
| SMF16A      | BP           | 17.80                                      | 19.70  | 1                       | 16                                  | 1.0   | 7.7                                     | 26.0  | X               |
| SMF17A      | BR           | 18.90                                      | 20.90  | 1                       | 17                                  | 1.0   | 7.2                                     | 27.6  | X               |
| SMF18A      | BT           | 20.00                                      | 22.10  | 1                       | 18                                  | 1.0   | 6.8                                     | 29.2  | X               |
| SMF20A      | BV           | 22.20                                      | 24.50  | 1                       | 20                                  | 1.0   | 6.2                                     | 32.4  | X               |
| SMF22A      | BX           | 24.40                                      | 26.90  | 1                       | 22                                  | 1.0   | 5.6                                     | 35.5  | X               |
| SMF24A      | BZ           | 26.70                                      | 29.50  | 1                       | 24                                  | 1.0   | 5.1                                     | 38.9  | X               |
| SMF26A      | CE           | 28.90                                      | 31.90  | 1                       | 26                                  | 1.0   | 4.8                                     | 42.1  | X               |
| SMF28A      | CG           | 31.10                                      | 34.40  | 1                       | 28                                  | 1.0   | 4.4                                     | 45.4  | X               |
| SMF30A      | CK           | 33.30                                      | 36.80  | 1                       | 30                                  | 1.0   | 4.1                                     | 48.4  | X               |
| SMF33A      | CM           | 36.70                                      | 40.60  | 1                       | 33                                  | 1.0   | 3.8                                     | 53.3  | X               |
| SMF36A      | CP           | 40.00                                      | 44.20  | 1                       | 36                                  | 1.0   | 3.4                                     | 58.1  | X               |
| SMF40A      | CR           | 44.40                                      | 49.10  | 1                       | 40                                  | 1.0   | 3.1                                     | 64.5  | X               |
| SMF43A      | CT           | 47.80                                      | 52.80  | 1                       | 43                                  | 1.0   | 2.9                                     | 69.4  | X               |
| SMF45A      | CV           | 50.00                                      | 55.30  | 1                       | 45                                  | 1.0   | 2.8                                     | 72.7  | X               |
| SMF48A      | CX           | 53.30                                      | 58.90  | 1                       | 48                                  | 1.0   | 2.6                                     | 77.4  | X               |
| SMF51A      | CZ           | 56.70                                      | 62.70  | 1                       | 51                                  | 1.0   | 2.4                                     | 82.4  | X               |
| SMF54A      | DE           | 60.00                                      | 66.30  | 1                       | 54                                  | 1.0   | 2.3                                     | 87.1  | X               |
| SMF58A      | RG           | 64.40                                      | 71.20  | 1                       | 58                                  | 1.0   | 2.1                                     | 93.6  |                 |
| SMF60A      | RK           | 66.70                                      | 73.70  | 1                       | 60                                  | 1.0   | 1.8                                     | 96.8  |                 |
| SMF64A      | RM           | 71.10                                      | 78.60  | 1                       | 64                                  | 1.0   | 1.7                                     | 103.0   |                 |
| SMF70A      | RP           | 77.80                                      | 86.00  | 1                       | 70                                  | 1.0   | 1.5                                     | 113.0   |                 |
| SMF75A      | RR           | 83.30                                      | 92.10  | 1                       | 75                                  | 1.0   | 1.4                                     | 121.0   |                 |
| SMF78A      | RT           | 86.70                                      | 95.80  | 1                       | 78                                  | 1.0   | 1.4                                     | 126.0   |                 |
| SMF85A      | RV           | 94.40                                      | 104.00 | 1                       | 85                                  | 1.0   | 1.3                                     | 137.0   |                 |

**Notes:**

- $V_{BR}$  measured after  $I_T$  applied for 300 $\mu\text{s}$ ,  $I_T$  = square wave pulse or equivalent.
- Surge current waveform per 10/1000 $\mu\text{s}$  exponential wave and derated per Fig.2.
- All terms and symbols are consistent with ANSI/IEEE C62.35.

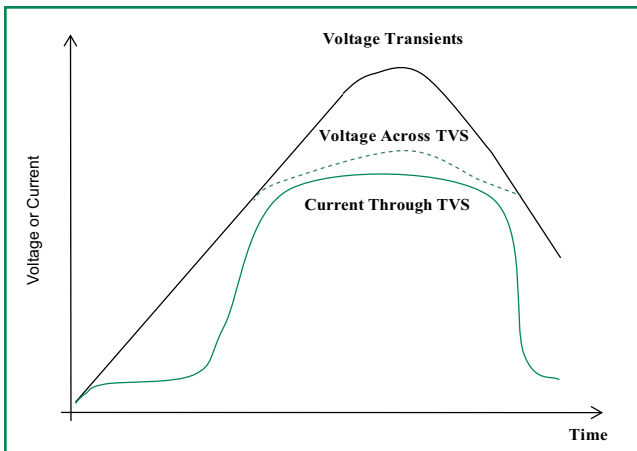
**I-V Curve Characteristics**



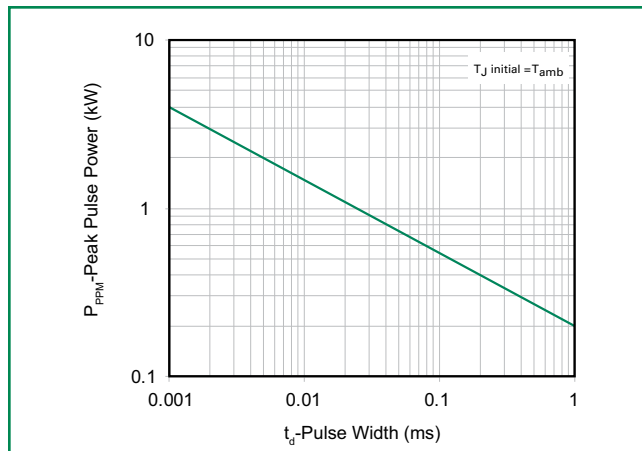
- $P_{PPM}$  Peak Pulse Power Dissipation** – Max power dissipation
- $V_R$  Stand-off Voltage** – Maximum voltage that can be applied to the TVS without operation
- $V_{BR}$  Breakdown Voltage** – Maximum voltage that flows through the TVS at a specified test current ( $I_T$ )
- $V_C$  Clamping Voltage** – Peak voltage measured across the TVS at a specified  $I_{ppm}$  (peak impulse current)
- $I_R$  Reverse Leakage Current** – Current measured at  $V_R$
- $V_F$  Forward Voltage Drop for Uni-directional**

**Ratings and Characteristic Curves ( $T_A=25^\circ\text{C}$  unless otherwise noted)**

**Figure 1 - TVS Transients Clamping Waveform**



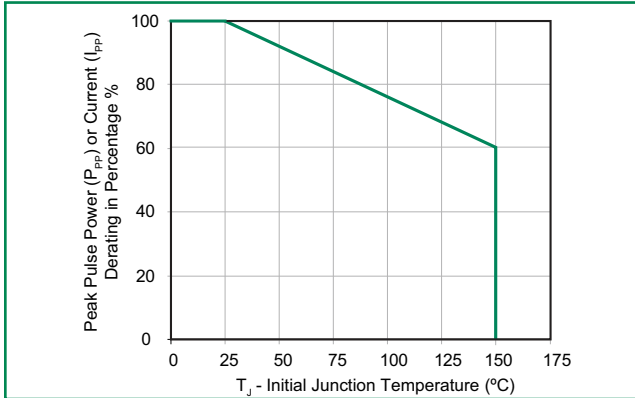
**Figure 2 - Peak Pulse Power Rating Curve**



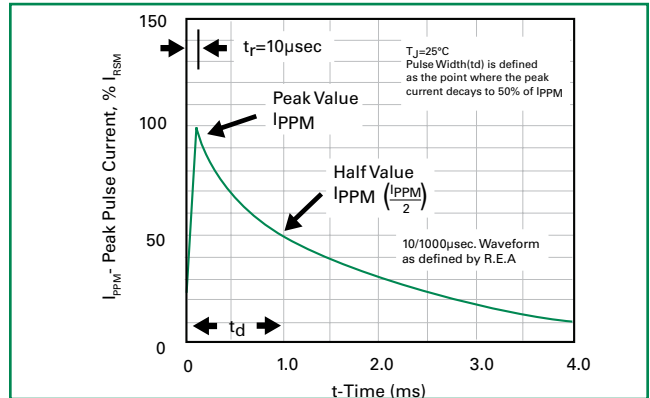
continues on next page.

### Ratings and Characteristic Curves ( $T_A=25^\circ\text{C}$ unless otherwise noted) (Continued)

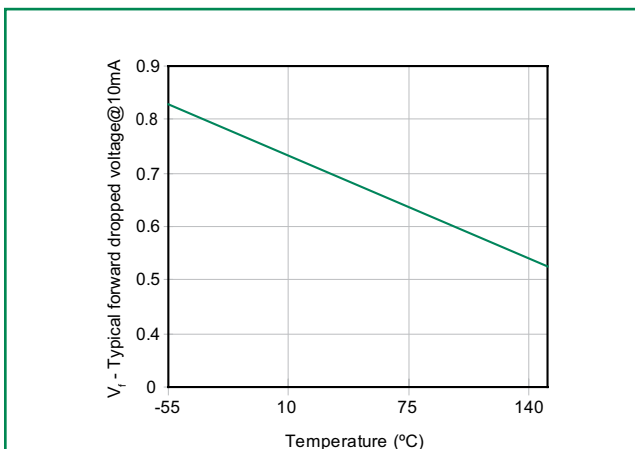
**Figure 3 - Peak Pulse Power Derating Curve**



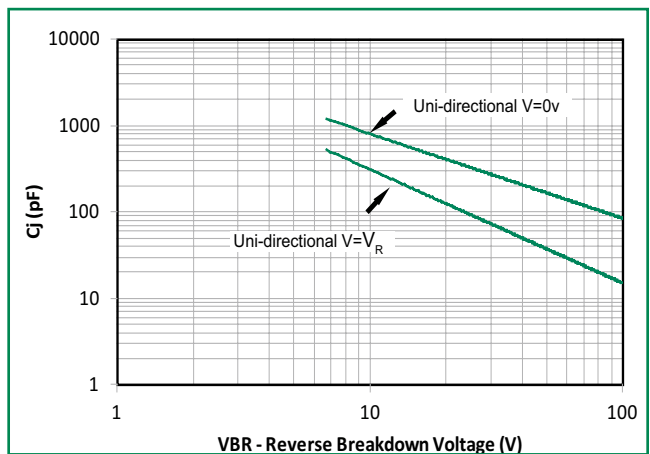
**Figure 4 - Pulse Waveform - 10/1000 $\mu\text{S}$**



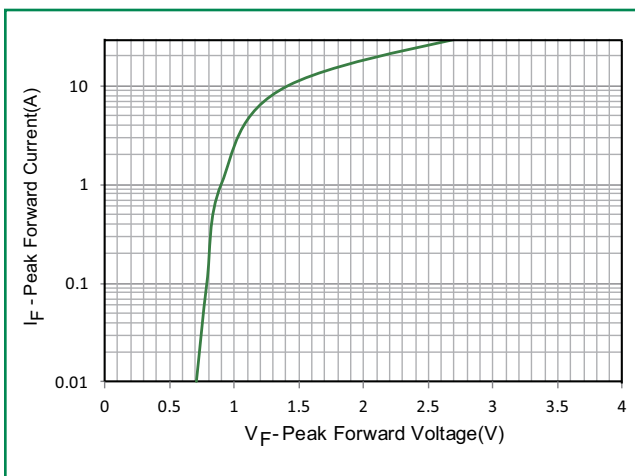
**Figure 5 - Forward Voltage**



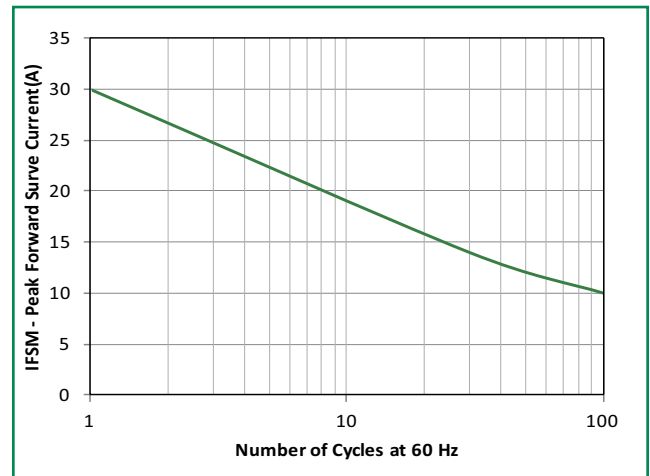
**Figure 6 - Typical Junction Capacitance**



**Figure 7 - Peak Forward Voltage Drop vs. Peak Forward Current**

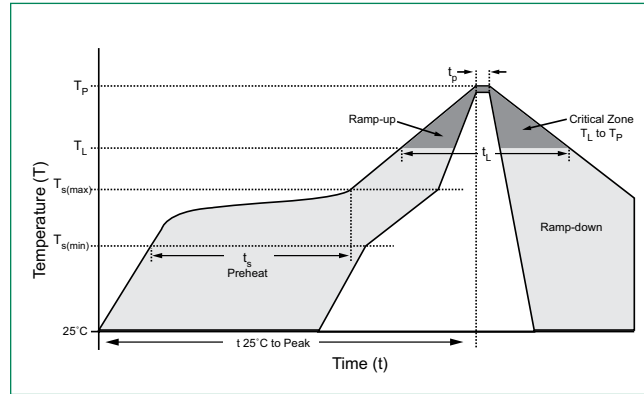


**Figure 8 - Maximum Non-Repetitive Forward Surge Current Uni-Directional Only**



### Soldering Parameters

|  |                                    |                         |
|--|------------------------------------|-------------------------|
| Reflow Condition                                       |                                    | Lead-free assembly      |
| Pre Heat   | - Temperature Min ( $T_{s(min)}$ ) | 150°C                   |
|  | - Temperature Max ( $T_{s(max)}$ ) | 200°C                   |
|  | - Time (min to max) ( $t_s$ )      | 60 – 180 secs           |
| Average ramp up rate (Liquidus Temp ( $T_A$ ) to peak) |                                    | 3°C/second max          |
| $T_{s(max)}$ to $T_A$ - Ramp-up Rate                   |                                    | 3°C/second max          |
| Reflow   | - Temperature ( $T_A$ ) (Liquidus) | 217°C                   |
|  | - Time (min to max) ( $t_s$ )      | 60 – 150 seconds        |
| Peak Temperature ( $T_p$ )                             |                                    | 260 <sup>+0/-5</sup> °C |
| Time within 5°C of actual peak Temperature ( $t_p$ )   |                                    | 20 – 40 seconds         |
| Ramp-down Rate   |                                    | 6°C/second max          |
| Time 25°C to peak Temperature ( $T_p$ )                |                                    | 8 minutes Max.          |
| Do not exceed  |                                    | 260°C                   |



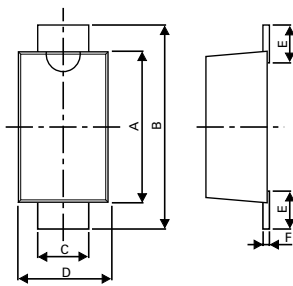
### Physical Specifications

|                 |  |
|-----------------|--|
| <b>Case</b>     | SOD-123FL plastic over glass passivated junction   |
| <b>Polarity</b> | Color band denotes cathode except bipolar          |
| <b>Terminal</b> | Matte tin-plated leads, solderable per JESD22-B102 |

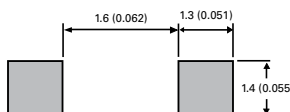
### Environmental Specifications

|                            |                          |
|----------------------------|--------------------------|
| <b>High Temp. Storage</b>  | JESD22-A103              |
| <b>HTRB</b>                | JESD22-A108              |
| <b>Temperature Cycling</b> | JESD22-A104              |
| <b>MSL</b>                 | JEDEC-J-STD-020, Level 1 |
| <b>H3TRB</b>               | JESD22-A101              |
| <b>RSH</b>                 | JESD22-A111              |

### Dimensions - SOD-123FL Package

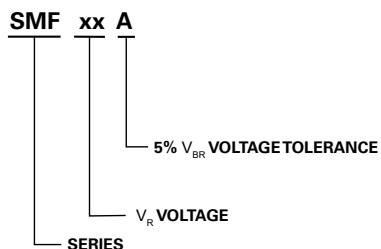


Mounting Pad Layout

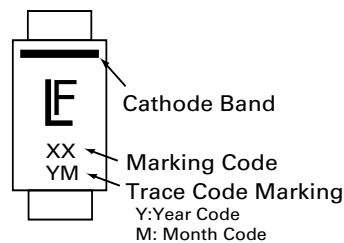


| Dimensions | Millimeters |      | Inches |        |
|------------|-------------|------|--------|--------|
|            | Min         | Max  | Min    | Max    |
| A          | 2.50        | 2.90 | 0.0984 | 0.1142 |
| B          | 3.40        | 3.90 | 0.1339 | 0.1535 |
| C          | 0.70        | 1.20 | 0.0275 | 0.0472 |
| D          | 1.50        | 2.00 | 0.0591 | 0.0787 |
| E          | 0.35        | 0.90 | 0.0138 | 0.0354 |
| F          | 0.05        | 0.26 | 0.0020 | 0.0102 |
| G          | 0.00        | 0.10 | 0.000  | 0.0039 |
| H          | 0.95        | 1.10 | 0.0374 | 0.0433 |

### Part Numbering System



### Part Marking System



### Packaging Options

| Part number | Component Package | Quantity | Packaging Option                | Packaging Specification |
|-------------|-------------------|----------|---------------------------------|-------------------------|
| SMFXXX      | SOD-123FL         | 3000     | Tape & Reel – 8mm tape/7" reel  | EIA RS-481              |
| SMFXXX-T13  | SOD-123FL         | 10000    | Tape & Reel – 8mm tape/13" reel | EIA RS-481              |

### Tape and Reel Specification

