

PRODUCT NO.
SEE TABLE

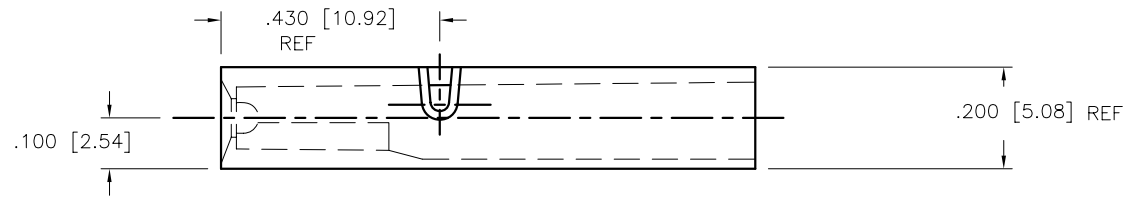

PIN CENTER WITH PV TERMINALS & PINS INSTALLED

SCALE 6:1

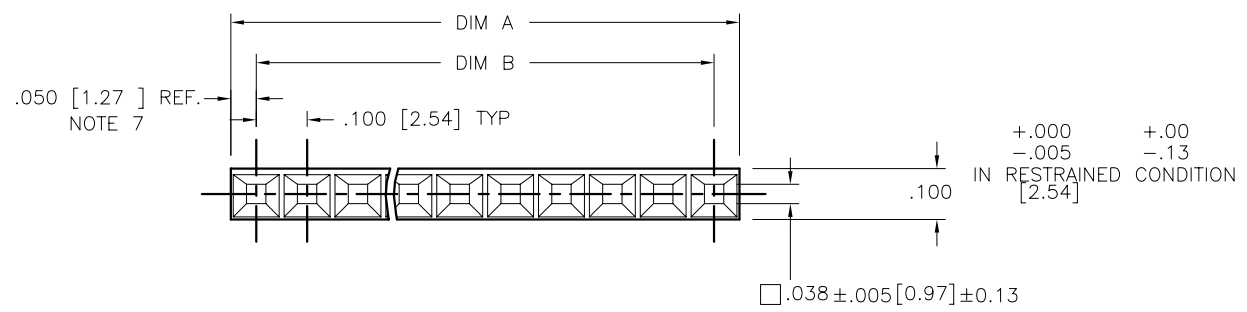
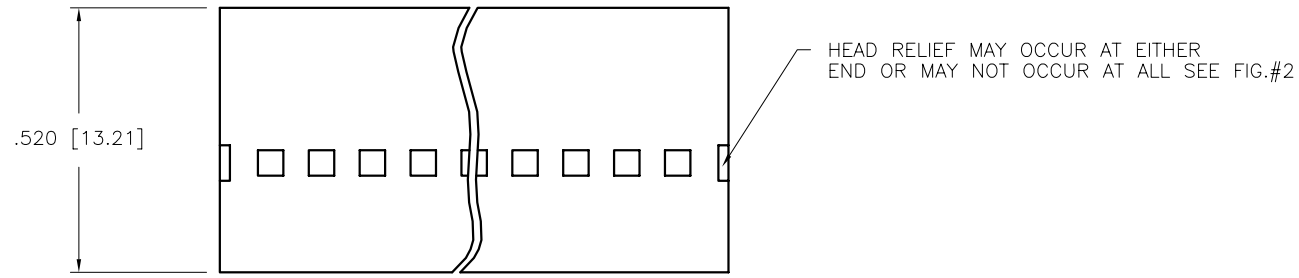

Copyright FCJ

mat'l code SEE NOTE 1 & 2				surface	tolerance	projection	product family
ltr	ec'n no	dr	date	tolerances unless otherwise specified		INCH/MM	PV HOUSINGS
E	v51436	SAR	1996-01-22	angles	linear		title
F	v90987	RGD	1999-06-22			scale 3:1	MINI ROD HOUSING SR
G	v05-0712	DAI	2005-07-27	0°±2'			.100 [2.54] CC WITH RODS
H	v06-0448	HTB	2006-05-19	dr	S. ROYER	1996-01-22	dwg no
J	v07-0563	HTB	2007-08-27	engr	T. HANNA	1996-01-22	sheet 1 of 3
				chr	T. BREWBAKER	1996-01-22	size
				appd	T. HANNA	1996-01-22	A3
sheet	revision	J	J	J			type
index	sheet	1	2	3			Product Customer Drawing

PRODUCT NO.	NO. OF CAV.	DIM 'A'	DIM 'B'	NOTES & RESTRICTIONS	SPECIAL MARKINGS	CUSTOMER RESTRICTS.	RETENTION ROD INFO		
							ROD P/N	QTY	DIM 'C' REF.
65272-001LF	31	3.105 [78.87]	3.000 [76.20]	NOTE 6			65048-005	1	4.65 [118.11]
65272-002LF	30	3.005 [76.33]	2.900 [73.66]	NOTE 6			65048-013	1	3.45 [87.63]
65272-003LF	29	2.905 [73.79]	2.800 [71.12]	NOTE 6			65048-013	1	3.45 [87.63]
65272-004LF	28	2.805 [71.25]	2.700 [68.58]	NOTE 6			65048-013	1	3.45 [87.63]
65272-005LF	27	2.705 [68.71]	2.600 [66.04]	NOTE 6			65048-013	1	3.45 [87.63]
65272-006LF	26	2.605 [66.17]	2.500 [63.50]	NOTE 6			65048-013	1	3.45 [87.63]
65272-007LF	25	2.505 [63.63]	2.400 [60.96]	NOTE 6			65048-013	1	3.45 [87.63]
65272-008LF	24	2.405 [61.09]	2.300 [58.42]	NOTE 6			65048-013	1	3.45 [87.63]
65272-009LF	23	2.305 [58.55]	2.200 [55.88]	NOTE 6			65048-013	1	3.45 [87.63]
65272-010LF	22	2.205 [56.01]	2.100 [53.34]	NOTE 6			65048-013	1	3.45 [87.63]
65272-011LF	21	2.105 [53.47]	2.000 [50.80]	NOTE 6			65048-013	1	3.45 [87.63]
65272-012LF	20	2.005 [50.93]	1.900 [48.26]	NOTE 6			65048-013	1	3.45 [87.63]
65272-013LF	19	1.905 [48.39]	1.800 [45.72]	NOTE 6			65048-026	1	2.30 [58.42]
65272-014LF	18	1.805 [45.85]	1.700 [43.18]	NOTE 6			65048-026	1	2.30 [58.42]
65272-015LF	17	1.705 [43.31]	1.600 [40.64]	NOTE 6			65048-026	1	2.30 [58.42]
65272-016LF	16	1.605 [40.77]	1.500 [38.10]	NOTE 6			65048-026	1	2.30 [58.42]
65272-017LF	15	1.505 [38.23]	1.400 [35.56]	NOTE 6			65048-026	1	2.30 [58.42]
65272-018LF	14	1.405 [35.69]	1.300 [33.02]				65048-026	1	2.30 [58.42]
65272-019LF	13	1.305 [33.15]	1.200 [30.48]				65048-026	1	2.30 [58.42]
65272-020LF	12	1.205 [30.61]	1.100 [27.94]				65048-026	1	2.30 [58.42]
65272-021LF	11	1.105 [28.07]	1.000 [25.40]				65048-026	1	2.30 [58.42]
65272-022LF	10	1.005 [25.53]	.900 [22.86]				65048-026	1	2.30 [58.42]
65272-023LF	9	.905 [22.99]	.800 [20.32]				65048-040	1	1.30 [33.02]
65272-024LF	8	.805 [20.45]	.700 [17.78]				65048-040	1	1.30 [33.02]
65272-025LF	7	.705 [17.91]	.600 [15.24]				65048-040	1	1.30 [33.02]
65272-026LF	6	.605 [15.37]	.500 [12.70]				65048-040	1	1.30 [33.02]
65272-027LF	5	.505 [12.83]	.400 [10.16]				65048-040	1	1.30 [33.02]
65272-028LF	4	.405 [10.29]	.300 [7.62]				65048-040	1	1.30 [33.02]
65272-029LF	3	.305 [7.75]	.200 [5.08]				65048-040	1	1.30 [33.02]
65272-030LF	2	.205 [5.21]	.100 [2.54]				65048-040	1	1.30 [33.02]
65272-031LF	8	.805 [20.45]	.700 [17.78]		STYLE A	X	65048-040	1	1.30 [33.02]
65272-032LF	10	1.005 [25.53]	.900 [22.86]		STYLE B		65048-026	1	2.30 [58.42]
65272-033LF	8	.805 [20.45]	.700 [17.78]				65048-040	1	1.30 [33.02]
65272-034LF	6	.605 [15.37]	.500 [12.70]				65048-040	1	1.30 [33.02]



FCconnect.com

Copyright FCJ

mat'l. code SEE NOTE 1 & 2				surface <input checked="" type="checkbox"/>		tolerance		projection		product family PV HOUSINGS			
ltr	ecr no	dr	date	tolerances unless otherwise specified									
J				angles	linear	.XX+01/XX-3		INCH/MM		title MINI ROD HOUSING SR			
				0'±2'		.XXX+005/XXX-13		scale 3:1		.100 [2.54] CC WITH RODS			
				dr	S. ROYER	1996-01-22				dwg no 65272			
				engr	T. HANNA	1996-01-22				sheet 2 of 3		size A3	
				chr	T. BREWBAKER	1996-01-22				type Product Customer Drawing			
				appd	T. HANNA	1996-01-22							
sheet index	revision sheet												

PRODUCT NUMBER
SEE TABLE

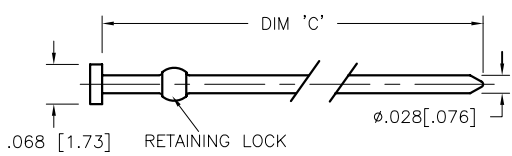

FIG. 1 RETENTION ROD DETAIL
SCALE 4:1

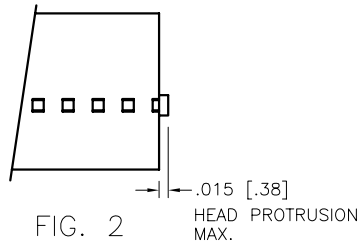

FIG. 2

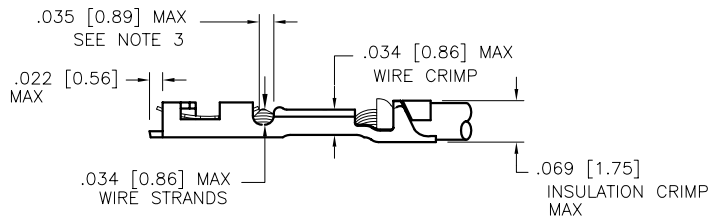
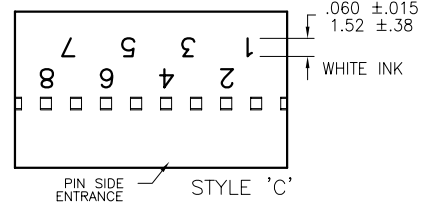
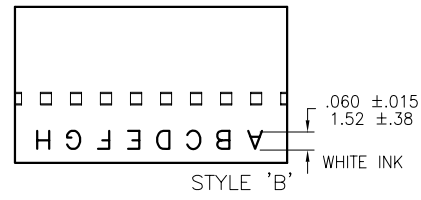
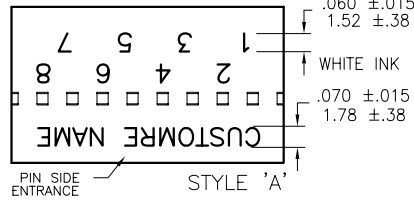

FIG. 3
RECOMMENDED
CRIMP INFORMATION
SCALE 4:1



NOTES:

- HOUSING MATERIAL: MODIFIED POLYPHENYLENE ETHER, FLAME RETARDANT PER UL 94V-0, COLOR: BLACK.
- ROD MATERIAL: NYLON (NATURAL COLOR) SEE FIGURE #1 FOR DIMENSIONS.
- TO MAKE PROPER CONTACT, ALL MALE PINS FOR EACH HOUSING MUST BE WITHIN $\pm 0.15/0.38$ IN LENGTH. MIN. PIN LENGTH IS $.180/4.57$.
- MAX. WIRE CRIMP AND WIRE STRANDS ARE SHOWN IN FIGURE #3 SEE MINI PV™ TERMINAL SPECIFICATION TA0210 FOR CORRECT CRIMP HEIGHT FOR EACH WIRE SIZE. PRODUCT SPECIFICATION: BUS-12-067.
- THIS HOUSING IS INTENDED FOR USE WITH MINI PV™ TERMINAL WITH 22-32 GAUGE WIRE, MEETING SPECIFICATIONS SHOWN IN FIG.#3.
- HEAD RELIEF WILL OCCUR AT LEAST ONCE PER HOUSING ON THESE LISTINGS.
- RETENTION RODS ARE INCLUDED WITH MINI ROD HOUSINGS. RODS TO BE TRIMMED AFTER INSERTION.
- PRODUCT MEETS EUROPEAN UNION DIRECTIVES AND OTHER COUNTRY REGULATIONS AS DESCRIBED IN GS-22-008.
- THE PRODUCT IS NOT INTENDED TO BE EXPOSED TO MANUFACTURING SOLDER PROCESS.

mat'l. code SEE NOTE 1 & 2		surface ✓	tolerance	projection ⊕	product family PV HOUSINGS
ltr	ecrn no	dr	date	tolerances unless otherwise specified	title
J				angles linear 0°±2°	INCH/MM scale 3:1
				dr S. ROYER 1996-01-22	MINI ROD HOUSING SR .100 [2.54] CC WITH RODS
				engr T. HANNA 1996-01-22	dwg no 65272 sheet 3 of 3 size A3
				chr T. BREWBAKER 1996-01-22	type Product Customer Drawing
				appd T. HANNA 1996-01-22	
sheet index	revision sheet				