

### Sensitivity Easily Adjusted with Teaching

- Four Amplifiers built into Four-channel Fiber Amplifier Models.
- Four Fiber Units can be wired close together and connected to a Four-channel Fiber Amplifier without mutual interference.
- Compact with a width of 32 mm (Four-channel Fiber Amplifier Models) and a width of 10 mm (One-channel Fiber Amplifier Models).
- Built-in initial operating level compensation function allows no-object teaching.



### Ordering Information

#### ■ Amplifier Units

Item	General-purpose	Multi-function	Four-channel	Waterproof red light source	Waterproof green light source
<b>Model</b>	E3X-NT11 (NPN output) E3X-NT41 (PNP output)	E3X-NT21 (NPN output) E3X-NT51 (PNP output)	E3X-NM11 (NPN output) E3X-NM41 (PNP output)	E3X-NV21 (NPN output)	E3X-NVG21 (NPN output)
<b>Appearance</b>					
<b>Light source</b>	Red LED ( $\lambda = 680 \text{ nm}$ )				Green LED ( $\lambda = 565 \text{ nm}$ )
<b>Power supply voltage</b>	12 to 24 VDC $\pm 10\%$ , ripple (p-p) 10% max.				
<b>Current consumption</b>	50 mA max.		150 mA max.	50 mA max.	
<b>Response time</b>	500 $\mu\text{s}$ max. at rated sensing distance				
<b>Control output</b>	PNP or NPN open collector, load current: 100 mA, residual voltage: 1 V max.				
<b>Timer function (see note)</b>	---	OFF-delay timer (fixed to 40 ms)	OFF-delay timer (fixed to 40 ms) (independent channel)	OFF-delay timer (fixed to 40 ms)	
<b>Teaching confirmation function</b>	Indicator (red/green LEDs) and buzzer				
<b>Remote teaching input</b>	---	Pink and blue (0 V) wires are short-circuited when remote input is ON. (0 V short-circuit current: 1 mA max.) Pink and blue (0 V) wires are not short-circuited when remote input is OFF. (Open or 9 V min.; max. input voltage: 24 V) Response time is 0.5 ms max. when remote input is OFF.		Blue and pink wires are short-circuited when remote input is ON. Blue and pink wires are not short-circuited when remote input is OFF.	
<b>Output</b>	Light ON and Dark ON switch selectable				

**Note:** It is possible to disable the OFF-delay timer function by using the switch setting.

## ■ Fiber Unit



Indicates models that allow free cutting. Models without this mark do not allow free cutting.

### Through-beam (Separate) Sensors

Model	Appearance	Sensing distance (standard object: opaque) (NT: E3X-NT□□□; NM: E3X-NM□□□ NV: E3X-NV21; NVG: E3X-NVG21)	Min. sensing object (opaque objects)	Features
E32-T11L	M4 screw	NT: 540 mm (1,280 mm <sup>*1</sup> ) (1.4-mm dia. min.) NM: 500 mm (1,200 mm <sup>*1</sup> ) (1.4-mm dia. min.) NV: 540 mm (1,280 mm <sup>*1</sup> ) (1.4-mm dia. min.) NVG: 40 mm (120 mm <sup>*1</sup> ) (1.4-mm dia. min.)	NT: 0.15-mm dia. NM: 0.2-mm dia. NV: 0.15-mm dia. NVG: 0.5-mm dia.	Long distance
E32-T12L	3-mm dia.	NT: 540 mm (1.4-mm dia. min.) NM: 500 mm (1.4-mm dia. min.) NV: 540 mm (1.4-mm dia. min.) NVG: 40 mm (1.4-mm dia. min.)	NT: 0.15-mm dia. NM: 0.2-mm dia. NV: 0.15-mm dia. NVG: 0.5-mm dia.	Long distance
E32-T21L	M3 screw	NT: 160 mm (0.9-mm dia. min.) NM: 150 mm (0.9-mm dia. min.) NV: 160 mm (0.9-mm dia. min.) NVG: 10 mm (0.9-mm dia. min.)	NT: 0.1-mm dia. NM: 0.2-mm dia. NV: 0.1-mm dia. NVG: 0.2-mm dia.	Long distance with thin fiber
E32-T22L	2-mm dia.	NT: 160 mm (0.9-mm dia. min.) NM: 150 mm (0.9-mm dia. min.) NV: 160 mm (0.9-mm dia. min.) NVG: 10 mm (0.9-mm dia. min.)	NT: 0.1-mm dia. NM: 0.2-mm dia. NV: 0.1-mm dia. NVG: 0.2-mm dia.	Long distance with thin fiber
E32-TC200	M4 screw	NT: 290 mm (2,100 mm <sup>*1</sup> ) (1-mm dia. min.) NM: 270 mm (2,000 mm <sup>*1</sup> ) (1-mm dia. min.) NV: 290 mm (2,100 mm <sup>*1</sup> ) (1-mm dia. min.) NVG: 28 mm (190 mm <sup>*1</sup> ) (1-mm dia. min.)	NT: 0.1-mm dia. NM: 0.2-mm dia. NV: 0.1-mm dia. NVG: 0.2-mm dia.	General-purpose
E32-TC200B E32-TC200B4	90 mm (40 mm) M4 screw ( ): E32-TC200B4	NT: 290 mm (1-mm dia. min.) NM: 270 mm (1-mm dia. min.) NV: 290 mm (1-mm dia. min.) NVG: 28 mm (1-mm dia. min.)	NT: 0.1-mm dia. NM: 0.2-mm dia. NV: 0.1-mm dia. NVG: 0.2-mm dia.	General-purpose
E32-T22	2-mm dia.	NT: 75 mm (0.5-mm dia. min.) NM: 70 mm (0.5-mm dia. min.) NV: 75 mm (0.5-mm dia. min.) NVG: 7 mm (0.5-mm dia. min.)	NT: 0.1-mm dia. NM: 0.2-mm dia. NV: 0.1-mm dia. NVG: 0.1-mm dia.	General-purpose
E32-TC200E	M3 screw	NT: 75 mm (0.5-mm dia. min.) NM: 70 mm (0.5-mm dia. min.) NV: 75 mm (0.5-mm dia. min.) NVG: 8 mm (0.5-mm dia. min.)	NT: 0.1-mm dia. NM: 0.2-mm dia. NV: 0.1-mm dia. NVG: 0.1-mm dia.	General-purpose
E32-TC200F E32-TC200F4	90 mm (40 mm) M3 screw ( ): E32-TC200F4	NT: 75 mm (0.5-mm dia. min.) NM: 70 mm (0.5-mm dia. min.) NV: 75 mm (0.5-mm dia. min.) NVG: 8 mm (0.5-mm dia. min.)	NT: 0.1-mm dia. NM: 0.2-mm dia. NV: 0.1-mm dia. NVG: 0.1-mm dia.	General-purpose
E32-TC200A	M3 screw	NT: 270 mm (1-mm dia. min.) NM: 250 mm (1-mm dia. min.) NV: 270 mm (1-mm dia. min.) NVG: 28 mm (1-mm dia. min.)	NT: 0.1-mm dia. NM: 0.2-mm dia. NV: 0.1-mm dia. NVG: 0.2-mm dia.	General-purpose
E32-T11	M4 screw	NT: 260 mm (1,400 mm <sup>*1</sup> ) (1-mm dia. min.) NM: 240 mm (1,300 mm <sup>*1</sup> ) (1-mm dia. min.) NV: 260 mm (1,400 mm <sup>*1</sup> ) (1-mm dia. min.) NVG: 10 mm (120 mm <sup>*1</sup> ) (1-mm dia. min.)	NT: 0.1-mm dia. NM: 0.2-mm dia. NV: 0.1-mm dia. NVG: 0.2-mm dia.	Flexible (resists breaking)
E32-T21	M3 screw	NT: 70 mm (0.5-mm dia. min.) NM: 65 mm (0.5-mm dia. min.) NV: 70 mm (0.5-mm dia. min.) NVG: 6 mm (0.5-mm dia. min.)	NT: 0.1-mm dia. NM: 0.2-mm dia. NV: 0.1-mm dia. NVG: 0.1-mm dia.	Flexible (resists breaking)
E32-T14L	3-mm dia.	NT: 140 mm (1-mm dia. min.) NM: 130 mm (1-mm dia. min.) NV: 140 mm (1-mm dia. min.) NVG: 10 mm (1-mm dia. min.)	NT: 0.2-mm dia. NM: 0.3-mm dia. NV: 0.2-mm dia. NVG: 0.1-mm dia.	Side-view; long distance
E32-T24	1-mm dia.	NT: 48 mm (0.5-mm dia. min.) NM: 45 mm (0.5-mm dia. min.) NV: 48 mm (0.5-mm dia. min.) NVG: 2 mm (0.5-mm dia. min.)	NT: 0.1-mm dia. NM: 0.2-mm dia. NV: 0.1-mm dia. NVG: 0.2-mm dia.	Side-view; space saving
E32-T14		NT: 1,070 mm (4-mm dia. min.) NM: 1,000 mm (4-mm dia. min.) NV: 1,070 mm (4-mm dia. min.) NVG: 80 mm (4-mm dia. min.)	NT: 0.2-mm dia. NM: 0.2-mm dia. NV: 0.2-mm dia. NVG: 0.2-mm dia.	Side-view; screw tightening type

\*1 Values in parentheses are for cases where the E39-F1 Lens Unit is used.



Indicates models that allow free cutting. Models without this mark do not allow free cutting.

Model	Appearance	Sensing distance (standard object: opaque) (NT: E3X-NT□□; NM: E3X-NM□□ NV: E3X-NV21; NVG: E3X-NVG21)			Min. sensing object (opaque objects)	Features
		NT	NM	NV		
E32-T17L	M4 screw	7,500 mm (10-mm dia. min.)	7,000 mm (10-mm dia. min.)	7,500 mm (10-mm dia. min.)	NT: 0.5-mm dia. NM: 0.7-mm dia. NV: 0.5-mm dia. NVG: 2.1-mm dia.	Through-beam with lens, for ideal explosion-proof applications
E32-T12F	5-mm dia.	1,070 mm (4-mm dia. min.)	1,000 mm (4-mm dia. min.)	1,070 mm (4-mm dia. min.)	NT: 0.3-mm dia. NM: 0.3-mm dia. NV: 0.3-mm dia. NVG: 0.6-mm dia.	Fluororesin-covered; withstands chemicals and harsh environments
E32-T14F	5-mm dia.	110 mm (3-mm dia. min.)	100 mm (3-mm dia. min.)		NT: 0.3-mm dia. NM: 0.3-mm dia.	Fluororesin covered ; side-view; withstands chemicals and harsh environments
E32-M21	M3 screw	210 mm (2-mm dia. min.)	200 mm (2-mm dia. min.)	210 mm (2-mm dia. min.)	NT: 0.1-mm dia. NM: 0.2-mm dia. NV: 0.1-mm dia. NVG: 0.3-mm dia.	4-head; 4-point detection
E32-T51	M4 screw	320 mm (1.5-mm dia. min.)	300 mm (1.5-mm dia. min.)	320 mm (1.5-mm dia. min.)	NT: 0.3-mm dia. NM: 0.4-mm dia. NV: 0.3-mm dia. NVG: 1.0-min. dia.	Heat-resistive; resists 150°C
E32-T54	2-mm dia.	85 mm (1-mm dia. min.)	70 mm (1-mm dia. min.)		NT: 0.4-mm dia. NM: 0.4-mm dia.	Heat-resistive; side-view; resists 150°C
E32-T61	M4 screw	190 mm (2,100 mm* <sup>1</sup> ) (1-mm dia. min.)	180 mm (2,000 mm* <sup>1</sup> ) (1-mm dia. min.)	190 mm (2,100 mm* <sup>1</sup> ) (1-mm dia. min.)	NT: 0.15-mm dia. NM: 0.2-mm dia. NV: 0.15-mm dia. NVG: 0.5-min. dia.	Heat-resistive; resists 300°C* <sup>2</sup>

\*<sup>1</sup> Values in parentheses are for cases where the E39-F1 Lens Unit is used. The operating ambient temperature is from -40°C to 200°C for the E39-F1 specifications.

\*<sup>2</sup> The resistive temperature varies with the part of the Fiber Unit. For details, refer to *Dimensions*.







Indicates models that allow free cutting. Models without this mark do not allow free cutting.



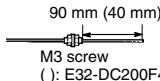

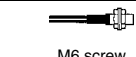

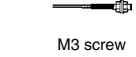



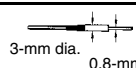

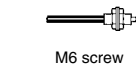

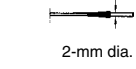

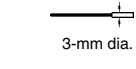

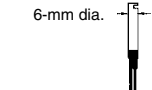
## Reflective Sensors

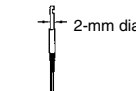
Model	Appearance	Sensing distance (standard object: opaque) (NT: E3X-NT□□; NM: E3X-NM□□ NV: E3X-NV21; NVG: E3X-NVG21)			Min. sensing object (copper wire)	Features
		White paper	Black paper	Standard object		
E32-D11L	M6 screw	NT: 160 mm NM: 150 mm NV: 160 mm NVG: 10 mm	NT: 44 mm NM: 40 mm NV: 44 mm NVG: ---	NT: 20 x 20 cm NM: 20 x 20 cm NV: 20 x 20 cm NVG: 2.5 x 2.5 cm	NT: 0.012-mm dia. NM: 0.015-mm dia. NV: 0.012-mm dia. NVG: 3.0-mm dia.	Long distance
E32-D12	3-mm dia.	NT: 85 mm NM: 80 mm NV: 85 mm NVG: 2 mm	NT: 22 mm NM: 20 mm NV: 22 mm NVG: ---	NT: 10 x 10 cm NM: 10 x 10 cm NV: 10 x 10 cm NVG: 2.5 x 2.5 cm	NT: 0.012-mm dia. NM: 0.015-mm dia. NV: 0.012-mm dia. NVG: 1.6-mm dia.	Long distance
E32-D21L	M4 screw	NT: 38 mm NM: 35 mm NV: 38 mm NVG: 1 mm	NT: 10 mm NM: 9 mm NV: 10 mm NVG: ---	NT: 5 x 5 cm NM: 5 x 5 cm NV: 5 x 5 cm NVG: 2.5 x 2.5 cm	NT: 0.012-mm dia. NM: 0.015-mm dia. NV: 0.012-mm dia. NVG: 1.0-mm dia.	Long distance
E32-D22L	3-mm dia.	NT: 38 mm NM: 35 mm NV: 38 mm NVG: 1 mm	NT: 10 mm NM: 9 mm NV: 10 mm NVG: ---	NT: 5 x 5 cm NM: 5 x 5 cm NV: 5 x 5 cm NVG: 2.5 x 2.5 cm	NT: 0.012-mm dia. NM: 0.015-mm dia. NV: 0.012-mm dia. NVG: 1.0-mm dia.	Long distance
E32-DC200	M6 screw	NT: 110 mm NM: 100 mm NV: 110 mm NVG: 10 mm	NT: 22 mm NM: 20 mm NV: 22 mm NVG: ---	NT: 10 x 10 cm NM: 10 x 10 cm NV: 10 x 10 cm NVG: 2.5 x 2.5 cm	NT: 0.012-mm dia. NM: 0.015-mm dia. NV: 0.012-mm dia. NVG: 0.2-mm dia.	General-purpose
E32-DC200B E32-DC200B4	90 mm (40 mm) M6 screw ( ): E32-DC200B4	NT: 110 mm NM: 100 mm NV: 110 mm NVG: 10 mm	NT: 22 mm NM: 20 mm NV: 22 mm NVG: ---	NT: 10 x 10 cm NM: 10 x 10 cm NV: 10 x 10 cm NVG: 2.5 x 2.5 cm	NT: 0.012-mm dia. NM: 0.015-mm dia. NV: 0.012-mm dia. NVG: 1.0-mm dia.	General-purpose
E32-DC200E	M3 screw	NT: 22 mm NM: 20 mm NV: 22 mm NVG: 2 mm	NT: 5 mm NM: 4.8 mm NV: 5 mm NVG: ---	NT: 2.5 x 2.5 cm NM: 2.5 x 2.5 cm NV: 2.5 x 2.5 cm NVG: 2.5 x 2.5 cm	NT: 0.012-mm dia. NM: 0.015-mm dia. NV: 0.012-mm dia. NVG: 1.0-mm dia.	General-purpose

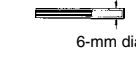
 Indicates models that allow free cutting. Models without this mark do not allow free cutting.

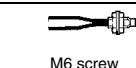
Model	Appearance	Sensing distance (standard object: opaque) (NT: E3X-NT□□; NM: E3X-NM□□ NV: E3X-NV21; NVG: E3X-NVG21)			Min. sensing object (copper wire)	Features
		White paper	Black paper	Standard object		
E32-DC200F E32-DC200F4 	 90 mm (40 mm) M3 screw ( ): E32-DC200F4	NT: 22 mm NM: 20 mm NV: 22 mm NVG: 2 mm	NT: 5 mm NM: 4.8 mm NV: 5 mm NVG: ---	NT: 2.5 x 2.5 cm NM: 2.5 x 2.5 cm NV: 2.5 x 2.5 cm NVG: 2.5 x 2.5 cm	NT: 0.012-mm dia. NM: 0.015-mm dia. NV: 0.012-mm dia. NVG: 1.0-mm dia.	General-purpose
E32-D11 	 M6 screw	NT: 65 mm NM: 60 mm NV: 65 mm NVG: 7 mm	NT: 14 mm NM: 13 mm NV: 14 mm NVG: ---	NT: 10 x 10 cm NM: 10 x 10 cm NV: 10 x 10 cm NVG: 2.5 x 2.5 cm	NT: 0.012-mm dia. NM: 0.015-mm dia. NV: 0.012-mm dia. NVG: 0.5-mm dia.	Flexible (resists breaking)
E32-D21 	 M3 screw	NT: 9 mm NM: 8 mm NV: 9 mm NVG: 1 mm	NT: 1.7 mm NM: 1.6 mm NV: 1.7 mm NVG: ---	NT: 2.5 x 2.5 cm NM: 2.5 x 2.5 cm NV: 2.5 x 2.5 cm NVG: 2.5 x 2.5 cm	NT: 0.012-mm dia. NM: 0.015-mm dia. NV: 0.012-mm dia. NVG: 1.0-mm dia.	Flexible (resists breaking)

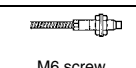
 Indicates models that allow free cutting. Models without this mark do not allow free cutting.

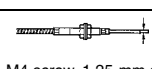
Model	Appearance	Sensing distance (standard object) (NT: E3X-NT□□; NM: E3X-NM□□ NV: E3X-NV21; NVG: E3X-NVG21)			Min. sensing object (copper wire)	Features
		White paper	Black paper	Standard object		
E32-D33 	 3-mm dia. 0.8-mm dia.	NT: 7 mm NM: 6 mm NV: 7 mm	NT: 1.4 mm NM: 1.3 mm NV: 1.4 mm	2.5 x 2.5 cm	NT: 0.012-mm dia. NM: 0.015-mm dia. NV: 0.012-mm dia.	Super-thin; minute object detection
E32-CC200 	 M6 screw	NT: 110 mm NM: 100 mm NV: 110 mm NVG: 10 mm	NT: 22 mm NM: 20 mm NV: 22 mm NVG: 2 mm	NT: 10 x 10 cm NM: 10 x 10 cm NV: 10 x 10 cm NVG: 2.5 x 2.5 cm	NT: 0.012-mm dia. NM: 0.015-mm dia. NV: 0.012-mm dia. NVG: 0.5-mm dia.	Coaxial; positioning accuracy
E32-D32 	 2-mm dia.	NT: 33 mm NM: 30 mm NV: 33 mm NVG: 2.5 mm	NT: 5.8 mm NM: 5.3 mm NV: 5.8 mm NVG: ---	2.5 x 2.5 cm	NT: 0.012-mm dia. NM: 0.015-mm dia. NV: 0.012-mm dia. NVG: 0.5-mm dia.	
E32-D32L 	 3-mm dia.	NT: 65 mm NM: 60 mm NV: 65 mm NVG: 4 mm	NT: 11 mm NM: 10 mm NV: 11 mm NVG: ---	NT: 10 x 10 cm NM: 10 x 10 cm NV: 10 x 10 cm NVG: 2.5 x 2.5 cm	NT: 0.012-mm dia. NM: 0.015-mm dia. NV: 0.012-mm dia. NVG: 1-mm dia.	
E32-D14L 	 6-mm dia.	NT: 44 mm NM: 40 mm NV: 44 mm NVG: 1.5 mm	NT: 8.8 mm NM: 8 mm NV: 8.8 mm NVG: ---	NT: 5 x 5 cm NM: 5 x 5 cm NV: 5 x 5 cm NVG: 2.5 x 2.5 cm	NT: 0.015-mm dia. NM: 0.03-mm dia. NV: 0.015-mm dia. NVG: 1.0-mm dia.	Side-view; long distance
E32-D24 	 2-mm dia.	NT: 17 mm NM: 15 mm NV: 17 mm NVG: 1.6 mm	NT: 2.8 mm NM: 2.5 mm NV: 2.8 mm NVG: ---	2.5 x 2.5 cm	NT: 0.012-mm dia. NM: 0.03-mm dia. NV: 0.012-mm dia. NVG: 1.0-mm dia.	Side-view; space saving
E32-D12F 	 6-mm dia.	NT: 55 mm NM: 50 mm NV: 55 mm NVG: 4 mm	NT: 16 mm NM: 15 mm NV: 16 mm NVG: ---	NT: 5 x 5 cm NM: 5 x 5 cm NV: 5 x 5 cm NVG: 2.5 x 2.5 cm	NT: 0.012-mm dia. NM: 0.03-mm dia. NV: 0.012-mm dia. NVG: 0.5-mm dia.	Fluororesin-covered; withstands chemicals and harsh environments
E32-D51 	 M6 screw	NT: 65 mm NM: 60 mm NV: 65 mm NVG: 5 mm	NT: 13 mm NM: 12 mm NV: 13 mm NVG: ---	NT: 10 x 10 cm NM: 10 x 10 cm NV: 10 x 10 cm NVG: 2.5 x 2.5 cm	NT: 0.012-mm dia. NM: 0.03-mm dia. NV: 0.012-mm dia. NVG: 1.0-mm dia.	Heat-resistant <sup>*1</sup> ; resists 150°C
E32-D61 	 M6 screw	NT: 50 mm NM: 45 mm NV: 50 mm NVG: 5 mm	NT: 10 mm NM: 9 mm NV: 10 mm NVG: ---	NT: 5 x 5 cm NM: 5 x 5 cm NV: 5 x 5 cm NVG: 2.5 x 2.5 cm	NT: 0.012-mm dia. NM: 0.03-mm dia. NV: 0.012-mm dia. NVG: 1.0-mm dia.	Heat-resistant <sup>*2</sup> ; resists 300°C
E32-D73 	 M4 screw 1.25-mm dia.	NT: 33 mm NM: 30 mm NV: 33 mm NVG: 3 mm	NT: 6.6 mm NM: 6 mm NV: 6.6 mm NVG: ---	NT: 5 x 5 cm NM: 5 x 5 cm NV: 5 x 5 cm NVG: 2.5 x 2.5 cm	NT: 0.012-mm dia. NM: 0.03-mm dia. NV: 0.012-mm dia. NVG: 1.0-mm dia.	Heat-resistant <sup>*2</sup> ; resists 400°C

**Note:** The Sensor may be set to the light-ON state if the sensitivity (teaching) is set to maximum, in which case, use the Sensor at a sensitivity setting other than the maximum level.

\*1 For continuous operation, use the products within a temperature range of -40°C to 130°C.

\*2 The resistive temperature varies with the part of the Fiber Unit. For details, refer to *Dimensions*.



Indicates models that allow free cutting. Models without this mark do not allow free cutting.

Model	Appearance	Sensing distance (standard object: opaque) (NT: E3X-NT□□; NM: E3X-NM□□ NV: E3X-NV21; NVG: E3X-NVG21)		Min. sensing object (copper wire)	Features
		White paper	Black paper		
E32-R21 +E39-R3*4	 M6 screw Reflector E39-R3	NT: 25 to 250 mm (35-mm dia. min.)*1 NM: 25 to 250 mm (35-mm dia. min.)*1 NV: 25 to 250 mm (35-mm dia. min.)	---	NT: 0.3-mm dia. NM: 0.6-mm dia. NV: 0.3-mm dia.	Transparent objects detection Retroreflective (with M.S.R. function)*5
E32-R16 +E39-R1*4	 Reflector E39-R1	NT: 150 to 1,500 mm (35-mm dia. min.)*1 NM: 150 to 1,500 mm (35-mm dia. min.)*1 NV: 150 to 1,500 mm (35-mm dia. min.)*1	---	NT: 0.5-mm dia. NM: 1.9-mm dia. NV: 0.5-mm dia.	Transparent objects detection
E32-L25*2		NT: 3.3 mm (2.5 x 2.5 cm) NM: 3.3 mm (2.5 x 2.5 cm) NV: 3.3 mm (2.5 x 2.5 cm)	---	NT: 0.012-mm dia. NM: 0.015-mm dia. NV: 0.012-mm dia.	Limited reflective; detects wafers and small difference in height
E32-L25A*2		NT: 3.3 mm (2.5 x 2.5 cm) NM: 3.3 mm (2.5 x 2.5 cm) NV: 3.3 mm (2.5 x 2.5 cm)*1	---	NT: 0.012-mm dia. NM: 0.015-mm dia. NV: 0.012-mm dia.	Limited reflective; detects wafers and small difference in height
E32-L25L*2, 3		NT: 7.2±1.8 mm (2.5 x 2.5 cm) NM: 7.2±1.8 mm (2.5 x 2.5 cm) NV: 7.2±1.8 mm (2.5 x 2.5 cm)*1	---	NT: 0.012-mm dia. NM: 0.015-mm dia. NV: 0.012-mm dia.	Limited reflective, long distance; detects wafers and small difference in height
E32-L24L*3		NT: 4±2 mm (2.5 x 2.5 cm) NM: 4±2 mm (2.5 x 2.5 cm) NV: 4±2 mm (2.5 x 2.5 cm)	---	NT: 0.012-mm dia. NM: 0.015-mm dia. NV: 0.012-mm dia.	Limited reflective, long distance, side-view; detects wafers and small difference in height

\*1 Standard object: opaque

\*2 For standard sensing distances, refer to *Dimensions*.

\*3 For continuous operation, use the products within a temperature range of -40°C to 90°C.

\*4 The operating ambient temperature of the reflectors supplied with the product are the same as that for the E32-R21 and E32-R16.

\*5 The M.S.R. (mirror surface rejection) function provides stable sensing for glossy objects.



Indicates models that allow free cutting. Models without this mark do not allow free cutting.

### Fine Through-beam Sensors

Model	Appearance	Sensing distance (standard object: opaque) (NT: E3X-NT□□; NM: E3X-NM□□ NV: E3X-NV21; NVG: E3X-NVG21)	Min. sensing object (opaque objects)	Features
E32-T22S	 3-mm dia.	NT: 650 mm (1.7-mm dia. min.) NM: 650 mm (1.7-mm dia. min.) NV: 650 mm (1.7-mm dia. min.)	NT: 0.2-mm dia. NM: 0.4-mm dia. NV: 0.2-mm dia.	General-purpose; detects wafers and small difference in height
E32-T24S	 3.5 x 3 mm dia.	NT: 480 mm (2-mm dia. min.) NM: 450 mm (2-mm dia. min.) NV: 480 mm (2-mm dia. min.)	NT: 0.2-mm dia. NM: 0.4-mm dia. NV: 0.2-mm dia.	Side-view; detects wafers and small difference in height
E32-T84S		NT: 480 mm (2-mm dia. min.) NM: 450 mm (2-mm dia. min.) NV: 480 mm (2-mm dia. min.)	NT: 0.3-mm dia. NM: 0.3-mm dia. NV: 0.3-mm dia.	L-shaped through-beam; heat resistance of up to 200°C.*

\* The resistive temperature varies with the part of the Fiber Unit. For details, refer to *Dimensions*.



### Slot Sensor

Model	Appearance	Sensing distance (standard object: opaque) (NT: E3X-NT□□; NM: E3X-NM□□ NV: E3X-NV21; NVG: E3X-NVG21)	Min. sensing object (opaque objects)	Features
E32-G14		10 mm (slot width)*1 (4-mm dia. min.)	NT: 0.4-mm dia. NM: 0.7-mm dia. NV: 0.4-mm dia. NVG: 0.6-mm dia.	Slot through-beam; no optical axis adjustment required

\*1 No-object teaching is not possible with the E32-G14 because the sensing distance of the E32-G14 is short and the light will be excessive. Perform with/without-object teaching instead.

 Indicates models that allow free cutting. Models without this mark do not allow free cutting.

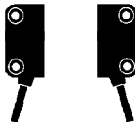
### High-precision Screen Sensors

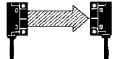
Model	Appearance	Slit width	Sensing distance (NT: E3X-NT□□□; NM: E3X-NM□□□ NV: E3X-NV21; NVG: E3X-NVG21)	Min. sensing object* <sup>1</sup> (horizontal beam)
E32-T16P 		Not used	NT: 480 mm NM: 400 mm NV: 480 mm	NT: 1.3-mm dia. (0.6-mm dia.) NM: 1.0-mm dia. (0.7-mm dia.) NV: 1.3-mm dia. (0.6-mm dia.)
		0.5 mm wide	NT: 80 mm NM: 65 mm NV: 80 mm	NT: 1.3-mm dia. (0.4-mm dia.) NM: 1.0-mm dia. (0.4-mm dia.) NV: 1.3-mm dia. (0.4-mm dia.)
		1.0 mm wide	NT: 160 mm NM: 130 mm NV: 160 mm	NT: 1.3-mm dia. (0.5-mm dia.) NM: 1.0-mm dia. (0.6-mm dia.) NV: 1.3-mm dia. (0.5-mm dia.)
E32-T16 		Not used	NT: 1,070 mm* <sup>2</sup> NM: 1,000 mm* <sup>2</sup> NV: 1,070 mm* <sup>2</sup> NVG: 150 mm* <sup>2</sup>	NT: 5.0-mm dia. (0.15-mm dia.) NM: 5.0-mm dia. (0.2-mm dia.) NV: 5.0-mm dia. (0.15-mm dia.) NVG: 7.0-mm dia. (1.0-mm dia.)
		0.5 mm wide	NT: 480 mm NM: 450 mm	NT: 5.0-mm dia. (0.1-mm dia.) NM: 5.0-mm dia. (0.2-mm dia.)
		1.0 mm wide	NT: 850 mm NM: 800 mm	NT: 5.0-mm dia. (0.1-mm dia.) NM: 5.0-mm dia. (0.3-mm dia.)

\*<sup>1</sup> Values at the sensing distance of 100 mm. Values not in parentheses represent sensing objects within the 11-mm sensing area except values for the T16. The values for the T16 represent sensing objects within the 10-mm sensing area. The diameters of sensing objects in the above table represent sensing object sizes, on condition that the objects are not moving.

\*<sup>2</sup> Visual field NT/NV: 2 x 10 mm, NM: 10 mm width, NVG: 2 x 10 mm.

#### Sensing Direction

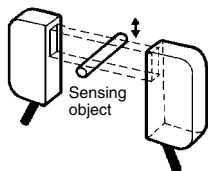

#### Mounting Bracket for E32-T16P (Option)

Sold in pairs.

Model	Applicable fibers	Appearance
E39-L94	E32-T16P	See page 36.

# Specifications

## ■ Ratings/Characteristics

### Amplifier Unit

Item	General-purpose		Multi-function		Four-channel		Waterproof red light source	Waterproof green light source
	E3X-NT11	E3X-NT41	E3X-NT21	E3X-NT51	E3X-NM11	E3X-NM41	E3X-NV21	E3X-NVG21
<b>NPN/PNP output</b>	NPN	PNP	NPN	PNP	NPN	PNP	NPN	NPN
<b>Indicator</b>	Orange LED: Lit during output operation Green LED: Lit with stable light reception or no light							
<b>Circuit protection</b>	Reverse polarity, output short-circuit, mutual interference prevention							
<b>Ambient temperature</b>	Operating: -25°C to 55°C (with no icing) Storage: -40°C to 70°C (with no icing)							
<b>Ambient humidity</b>	Operating: 35% to 85% (with no condensation)							
<b>Ambient illumination</b>	Sunlight: 10,000 lx max.; Incandescent lamp: 3,000 lx max.							
<b>Insulation resistance</b>	20 MΩ min. (at 500 VDC)							
<b>Dielectric strength</b>	1,000 VAC, 50/60 Hz for 1 min							
<b>Vibration resistance</b>	10 to 55 Hz, 1.5-mm double amplitude or 300 m/s <sup>2</sup> (approx. 30G) for 2 hrs each in X, Y, and Z directions							
<b>Shock resistance</b>	500 m/s <sup>2</sup> (approx. 50G) for 3 times each in X, Y, and Z directions							
<b>Degree of protection</b>	IEC60529 IP50 (with protective cover in place)						IEC60529 IP66 (with protective cover in place)	
<b>Material</b>	Case: PBT; Cover: Polycarbonate						Case: Heat-resisting ABS; Cover: Polycarbonate	
<b>Cord length</b>	Prewired (2 m)							
<b>Connection method</b>	V <sub>cc</sub> : Brown 0 V: Blue Control output: Black Remote teaching input: Pink (E3X-NT21/-NT51 only)				V <sub>cc</sub> : Brown 0 V: Blue Control output 1: Black Control output 2: White Control output 3: Grey Control output 4: Orange Remote teaching input: Pink		V <sub>cc</sub> : Brown 0 V: Blue Control output : Black Remote teaching input: Pink	
<b>Weight (with 2-m cord)</b>	Approx. 100 g				Approx. 200 g		Approx. 100 g	

### Fiber Unit

#### Common

<b>Ambient storage temperature</b>	Heat-resistive fiber: -40°C to 110°C (with no icing) Other fibers: -40°C to 70°C (with no icing)
<b>Ambient storage humidity</b>	Operating: 35% to 95% (with no condensation)
<b>Vibration resistance</b>	10 to 55 Hz, 1.5-mm double amplitude for 2 hrs each in X, Y, and Z directions
<b>Shock resistance</b>	500 m/s <sup>2</sup> (approx. 50G) for 3 times each in X, Y, and Z directions

## Through-beam (Separate) Sensors

Model	Ambient temperature	Ambient humidity	Permissible bending radius	Material	Degree of protection
E32-T11L	Operating: -40°C to 70°C (with no icing)	Operating: 35% to 85%	25 mm min.	Black polyethylene	IEC60529 IP67
E32-T12L					
E32-T21L					
E32-T22L					
E32-TC200					
E32-TC200B E32-TC200B4					
E32-T22					
E32-TC200E					
E32-TC200F E32-TC200F4					
E32-TC200A					
E32-T11					
E32-T21					
E32-T14L					
E32-T24					
E32-T14					
E32-T17L					
E32-T12F	Operating: -30°C to 70°C (with no icing)		40 mm min.	Fluoresin-covered black polyethylene	
E32-T14F					
E32-M21	Operating: -40°C to 70°C (with no icing)		25 mm min.	Black polyethylene	
E32-T51	Operating: -40°C to 150°C* <sup>1</sup> (with no icing)		35 mm min.	Fluoride resin	
E32-T54					
E32-T61	Operating: -40°C to 300°C* <sup>2</sup> (with no icing)		25 mm min.	SUS	

\*<sup>1</sup> When used continuously between -40°C and 130°C.

\*<sup>2</sup> The resistive temperature varies with the part of the Fiber Unit. For details, refer to Dimensions.



## Reflective Sensors

Model	Differential travel	Ambient temperature	Ambient humidity	Permissible bending radius	Material	Degree of protection
E32-D11L	20% of max. of sensing distance	Operating: -40°C to 70°C (with no icing)	Operating: 35% to 85%	25 mm min.	Black polyethylene	IEC60529 IP67
E32-D12						
E32-D21L						
E32-D22L						
E32-DC200						
E32-DC200B						
E32-DC200B4						
E32-DC200E						
E32-DC200F						
E32-DC200F4						
E32-D11						
E32-D21						
E32-DC9G						
E32-DC9G4						
E32-D33						
E32-CC200						
E32-D32						
E32-D32L						
E32-D14L						
E32-D24						
E32-D12F	5% of max. of sensing distance	Operating: -30°C to 70°C (with no icing)	Operating: -40°C to 70°C (with no icing)	40 mm min.	Fluororesin-covered black polyethylene	IEC60529 IP67
E32-D51		Operating: -40°C to 150°C (with no icing)* <sup>1</sup>		35 mm min.	Fluoride resin	
E32-D61		Operating: -40°C to 300°C (with no icing)* <sup>2</sup>		25 mm min.	SUS	
E32-D73		Operating: -40°C to 400°C (with no icing)* <sup>2</sup>		Black polyethylene	IEC60529 IP66	
E32-R21 with E39-R3		Operating: -40°C to 70°C (with no icing)				
E32-R16 with E39-R1		Operating: -25°C to 55°C (with no icing)		Reinforced polyethylene	IEC60529 IP50	
E32-L25* <sup>3</sup>		Operating: -40°C to 70°C (with no icing)				
E32-L25A* <sup>3</sup>		Operating: -40°C to 105°C* <sup>4</sup>				
E32-L25L* <sup>3</sup>						
E32-L24L* <sup>3</sup>				10 mm min. (average at 10% decrease of sensing distance)		

**Note:** The Sensor may be set to the light-ON state if the sensitivity (teaching) is set to maximum, in which case, use the Sensor at a sensitivity setting other than the maximum level.

\*<sup>1</sup> When used continuously between -40°C and 130°C.

\*<sup>2</sup> The resistive temperature varies with the part of the Fiber Unit. For details, refer to *Dimensions*.

\*<sup>3</sup> Beam size: 2-mm dia.

\*<sup>4</sup> For continuous operation, use the products within a temperature range of -40°C to 90°C.

## Fine Through-beam Sensors

Model	Beam size	Differential travel	Horizontal positioning accuracy	Ambient temperature	Ambient humidity	Permissible bending radius	Material	Degree of protection
E32-T22S	13 mm dia. (at a distance of 200 mm)	---	---	Operating: -40°C to 70°C (with no icing)	Operating: 35% to 85%	10 mm min.*	Reinforced laminated vinyl chloride	IEC60529 IP67
E32-T24S				Operating: -40°C to 200°C (with no icing)		25 mm min.	SUS	
E32-T84S								

\* Average at 10% decrease of sensing distance

## Slot Sensor

Model	Ambient temperature	Ambient humidity	Permissible bending radius	Material	Degree of protection
E32-G14	Operating: -40°C to 70°C (with no icing)	Operating: 35% to 85%	25 mm min.	Fiber sheath: Black polyethylene	IEC60529 IP67



## High-precision Screen Fiber Unit

Model	Ambient temperature	Ambient humidity	Permissible bending radius*1	Material	Degree of protection
E32-T16P	Operating: -40°C to 70°C (with no icing)	Operating: 35% to 85%	10 mm min.	Sensing head: Heat-resistive ABS Fiber sheath: Vinyl chloride	IEC60529 IP50
E32-T16			25 mm min.	Sensing head: Heat-resistive ABS Sensing surface: PMMA Fiber sheath: Black polyethylene	IEC60529 IP67

\*1 Average at 10% decrease of sensing distance

\*2 Attachments: two slits each (0.5 mm and 1.0 mm wide)

## Attachments



Name		Small Spot Lens Unit	Long Distance Lens Unit		
Applications		Detection over 0.5-mm-dia. spots	Increasing sensing distance		
Model		E39-F3A	E39-F1		
Appearance		Reflective 	Through-beam (separate) 		
Applicable fibers		E32-D32	E32-T11L	E32-TC200 E32-T61	E32-T11
With E3X-NT□□	Sensing distance	22 mm*1	1,280 mm	2,100 mm	1,400 mm
	Standard object	White paper 2.5 x 2.5 cm	Opaque objects: 4-mm dia. min.		
With E3X-NM□□	Sensing distance	20 mm*1	1,200 mm	2,000 mm	1,300 mm
	Standard object	White paper 2.5 x 2.5 cm	Opaque objects: 4-mm dia. min.		
With E3X-NV21	Sensing distance	22 mm*1	1,280 mm	2,100 mm	1,400 mm
	Standard object	White paper 2.5 x 2.5 cm	Opaque objects: 4-mm dia. min.		
With E3X-NVG21	Sensing distance	---	120 mm	190 mm*2	120 mm
	Standard object	---	Opaque objects: 4-mm dia. min.		
Directivity		---	5° to 40°		
Differential travel		20% of sensing distance	---		
Ambient temperature		Operating: -40°C to 70°C	E32-T61: -40°C to 200°C (Do not exceed the operating temperature of the fiber. )		
Material	Shaft	Aluminum	Brass		
	Lens	Optical glass			
	Base	---			
	Reflector	---			

\*1 When inserting 15 mm.

\*2 130 mm for the E32-T61.

Name		Side-view Unit		
Applications		Changing the sensing direction at 90°		
Model		E39-F2		
Appearance		Through-beam (separate) 		
Applicable fibers		E32-T11L	E32-TC200	E32-T61/11
With E3X-NT□□	Sensing distance	265 mm	265 mm	210 mm
	Standard object	Opaque objects: 3-mm dia. min.		
With E3X-NM□□	Sensing distance	250 mm	250 mm	200 mm
	Standard object	Opaque objects: 3-mm dia. min.		
With E3X-NV21	Sensing distance	265 mm	265 mm	210 mm
	Standard object	Opaque objects: 3-mm dia. min.		
With E3X-NVG21	Sensing distance	10 mm	19 mm	10 mm
	Standard object	Opaque objects: 4-mm dia. min.	Opaque objects: 3-mm dia. min.	
Directivity		20° to 60°		
Differential travel		---		
Ambient temperature		E32-T61: -40°C to 200°C (Do not exceed the operating temperature of the fiber.)		
Material	Shaft	Brass		
	Lens	Optical glass		
	Base	---		
	Reflector	---		

Name		Lens-equipped Reflective Unit		
Applications		Converting through-beam sensors to reflective sensors		
Model		E39-F3		
Appearance		Reflective 		
Applicable fibers		E32-T11L	E32-TC200	E32-T61
With E3X-NT□□	Sensing distance (standard object)	White paper	55 to 160 mm*1	85 to 110 mm*1
		Black paper	---	16 to 18 mm*1   17 to 19 mm*1
With E3X-NM□□	Sensing distance (standard object)	White paper	55 to 150 mm*1	85 to 100 mm*1
		Black paper	---	15 to 17 mm*1   16 to 18 mm*1
With E3X-NV21	Sensing distance (standard object)	White paper	55 to 160 mm*1	85 to 110 mm*1
		Black paper	---	16 to 18 mm*1   16 to 18 mm*1
With E3X-NVG21	Sensing distance (standard object)	White paper	---	10 to 15 mm (2.5 x 2.5 cm)
		Black paper	---	---
Directivity		---		
Differential travel		20% of sensing distance		
Ambient temperature		E32-T61: -40°C to 200°C (Do not exceed the operating temperature of the fiber.)		
Material	Shaft	Brass		
	Lens	Optical glass		
	Base	Aluminum		
	Reflector	---		

Name			Lens-equipped Reflective Unit	Side-view Reflective Unit
Applications			Converting through-beam sensors to reflective sensors	Converting through-beam to reflective sensor
Model			E39-F3	E39-F5
Appearance			Reflective 	Reflective 
Applicable fibers			E32-T11	E32-TC200A
With E3X-NT□□	Sensing distance (standard object)	White paper	90 to 110 mm* <sup>1</sup>	5 to 32 mm
		Black paper	---	6 to 10 mm
With E3X-NM□□	Sensing distance (standard object)	White paper	90 to 100 mm* <sup>1</sup>	5 to 30 mm
		Black paper	---	6 to 9 mm
With E3X-NV21	Sensing distance (standard object)	White paper	90 to 110 mm* <sup>1</sup>	5 to 32 mm
		Black paper	---	6 to 10 mm
With E3X-NVG21	Sensing distance (standard object)	White paper	---	---
		Black paper	---	---
Directivity			---	
Differential travel			20% of sensing distance	
Ambient temperature			E32-T61: -40°C to 200°C (Do not exceed the operating temperature of the fiber.)	Operating: -40°C to 70°C
Material	Shaft		Brass	---
	Lens		Optical glass	---
	Base		Aluminum	Brass
	Reflector		---	Stainless

\*1 These values are possible when the angle of the E39-F3 is smallest (parallel).

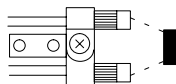

## Beam Spot Characteristics

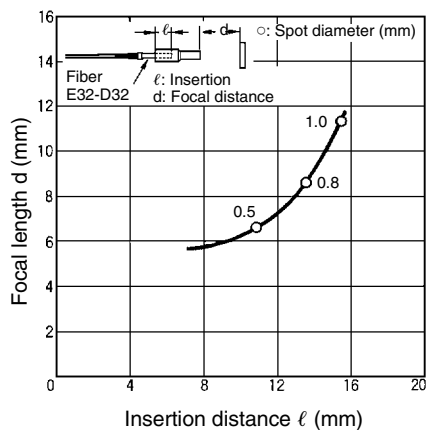

### E39-F3A with E32-D32

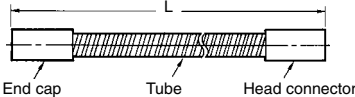

## Spiral Tubes

Model	E39-F32A5	E39-F32A	E39-F32B5	E39-F32B	E39-F32C5	E39-F32C	E39-F32D5	E39-F32D
Appearance	 End cap      Tube      Head connector							
Length (L)	500 mm	1,000 mm	500 mm	1,000 mm	500 mm	1,000 mm	500 mm	1,000 mm
Applicable fiber	E32-DC200E E32-DC200F(4) E32-D21		E32-TC200E E32-TC200F(4) E32-T21 E32-T21L		E32-TC200 E32-TC200B(4) E32-T11 E32-T51 E32-T11L		E32-DC200 E32-DC200B(4) E32-CC200 E32-D11 E32-D51 E32-D11L	
Ambient temperature	Operating: -40°C to 150°C (Do not exceed the operating temperature of the fiber)							
Ambient humidity	Operating: 35% to 85%							
Permissible bending radius	30 mm min.							
Tensile strength	Between head connector and end cap with tube: 1.5 N • m (15 kgf • cm) Tube: 2 N • m (20 kgf • cm)							
Compression load	Tube: 29.4 N (3 kg)							

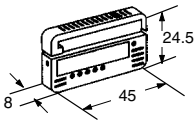
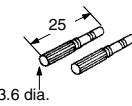
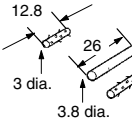
## Accessories

Name	Fiber Cutter	Fine-fiber Attachment	Fiber Connector	Sleeve Bender
Model	E39-F4	E39-F9	E39-F10	E39-F11
Appearance				
Features	Used to cut fibers to desired lengths	Used when inserting fine fibers into the amp	Used to connect fibers for extension	Used to bend fiber sleeves
Applicable fiber	All models equipped with fibers that can be trimmed.	E32-DC200E, -TC200E E32-DC200F(4), -TC200F(4) E32-D21, -D21L, -D22L E32-T21, -T21L, -T22L E32-D32, -T22 E32-D24, -T24 E32-D33 E32-R21, E32-D21R	E32-DC200, -TC200 E32-DC200B(4), -TC200B(4) E32-TC200A E32-T14, -G14 E32-D11L, -T11L, -T12L E32-D14L, -T14L E32-T17L	E32-TC200B(4) E32-DC200F(4), -TC200F(4) E32-DC9G(4)
	Provided with Fiber Units		Sold Separately	

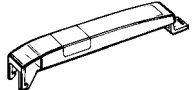
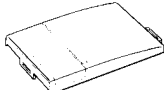
Name	Protection Cover	
Model	E39-G10 (see note)	E39-G9
Appearance		
Application	Replacement part: Order when the Protection Cover included with the Amplifier is damaged or lost.	
Applicable Amplifier	E3X-NT	E3X-NM

**Note:** Cannot be mounted on the push type as shown below.

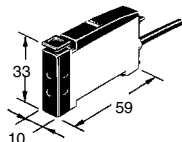

# Engineering Data

## ■ Excess Gain Ratio (Typical)

With Standard Sensing Object at Max. Sensitivity

The characteristics of the E3X-NV are the same as for the E3X-NT.

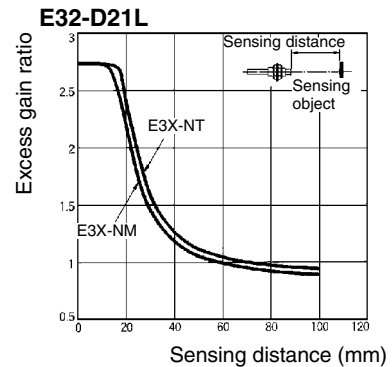
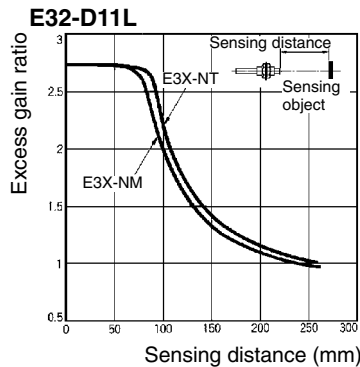
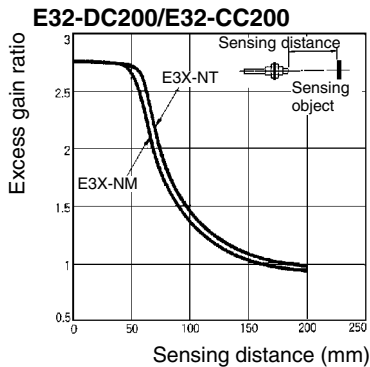
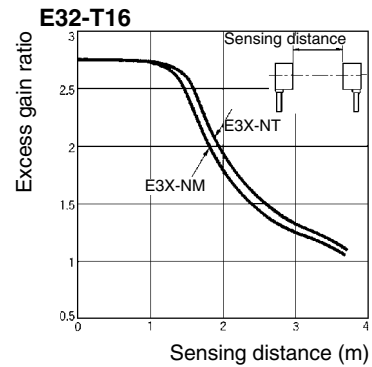
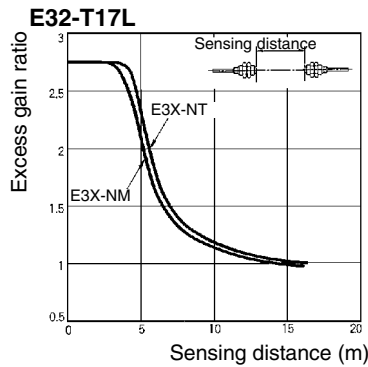
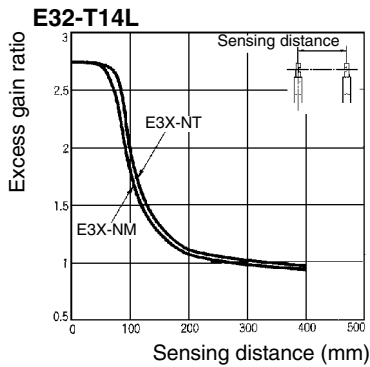
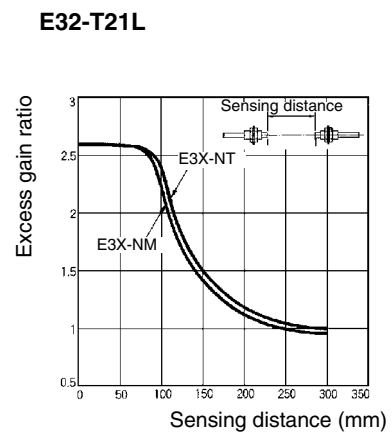
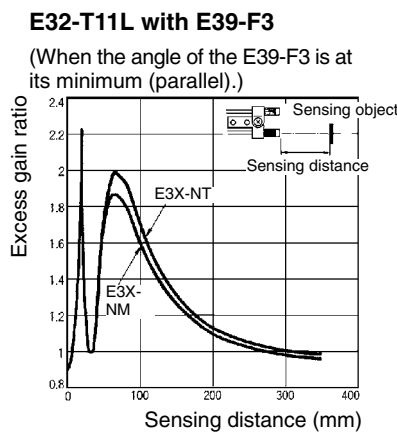
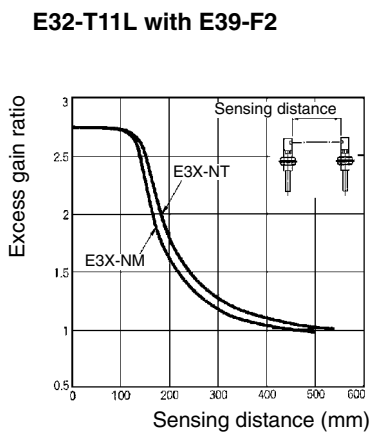
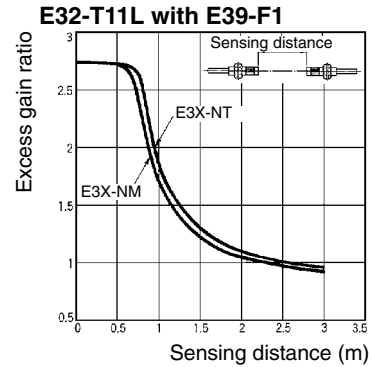
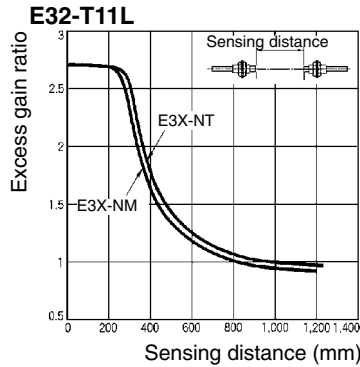
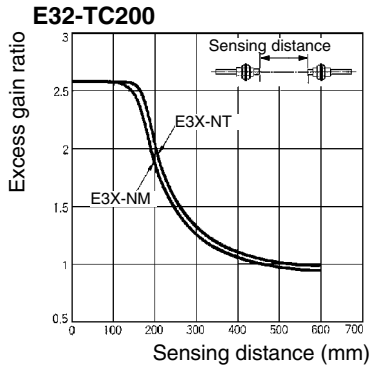

**E32-T16P**

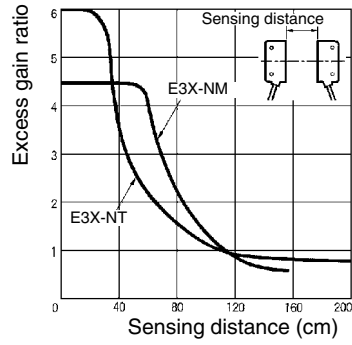

**E32-T22S**

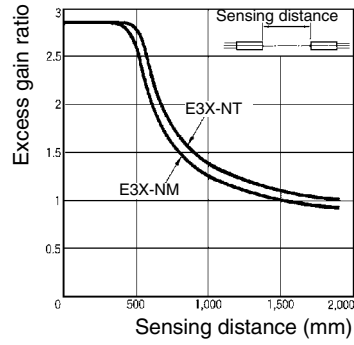

**E32-T24S**

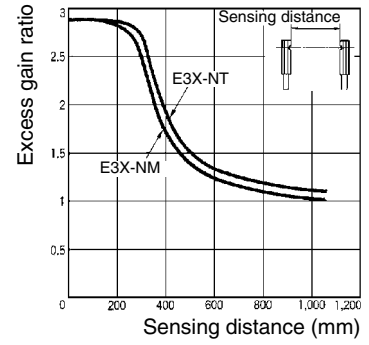

**E32-T54**

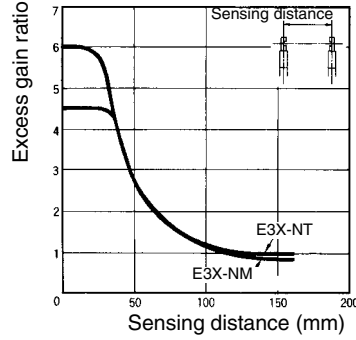

**E32-T14F**

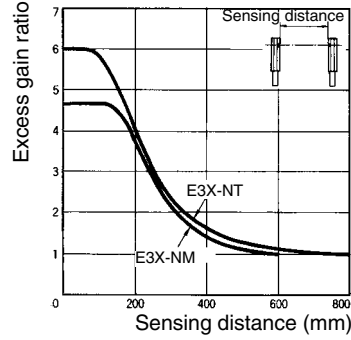

**■ Operating Range (Typical)**

With standard sensing object at max. sensitivity.

The characteristics of the E3X-NV are the same as for the E3X-NT.

**E32-DC200**

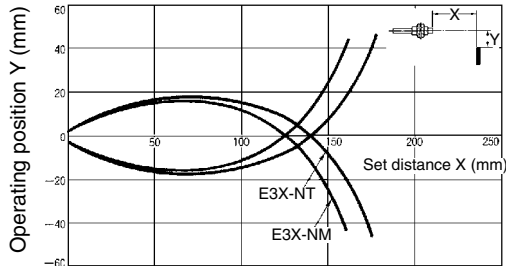

**E32-D11L**

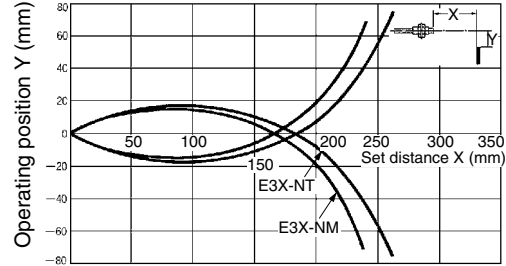

**E32-D12**

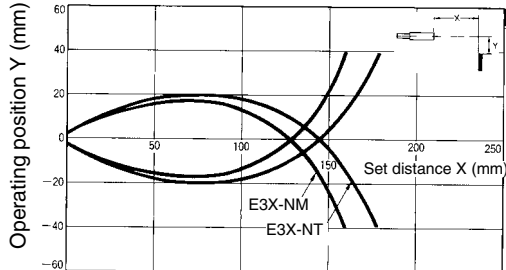

**E32-D21L**

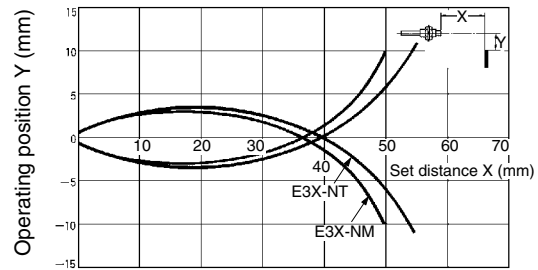

**E32-DC200E**

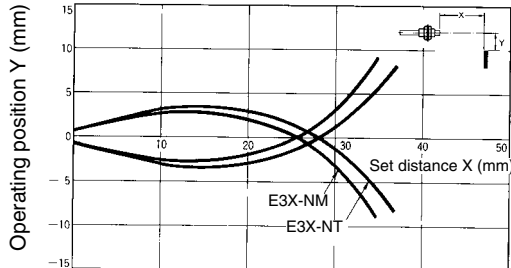

**E32-D11**

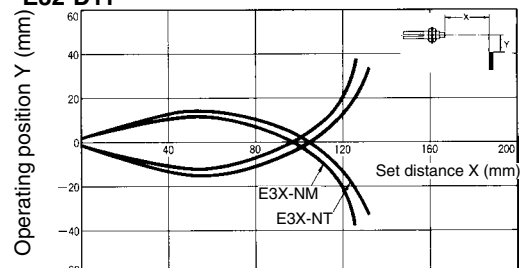

E32-D21

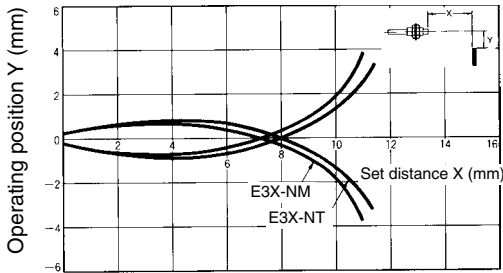

E32-D33

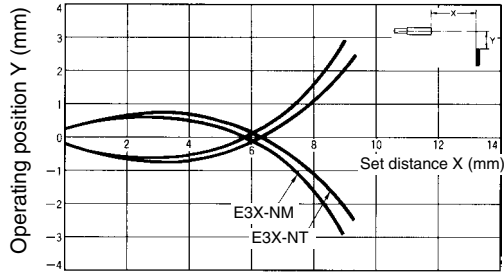

E32-CC200

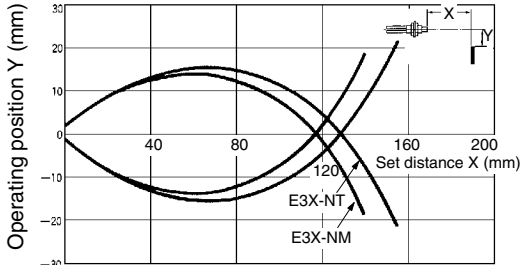

E32-D32

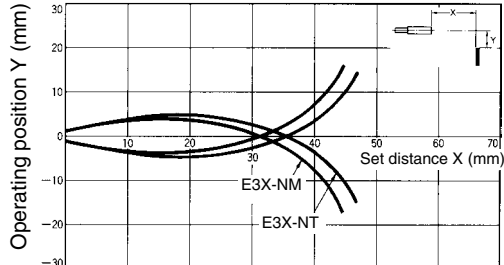

E32-D32L

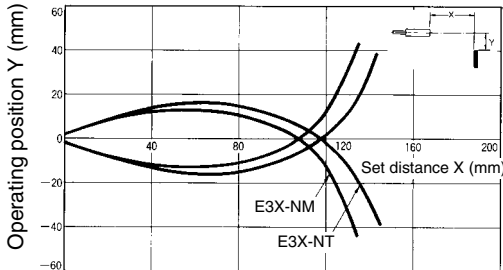

E32-D14L

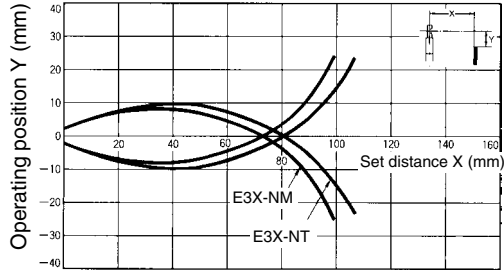

E32-D24

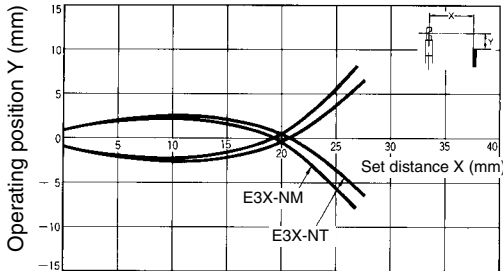

E32-D51

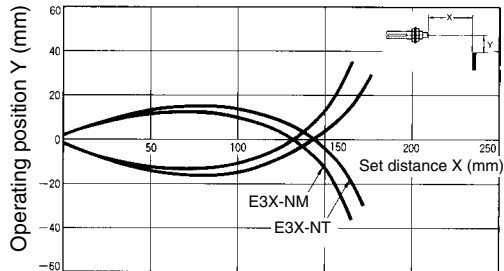

E32-D61

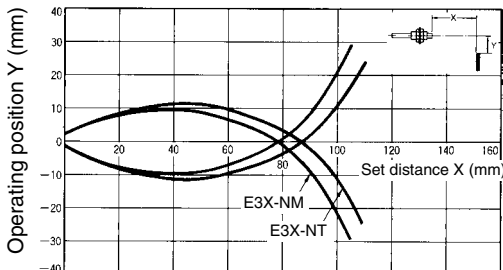

E32-D73

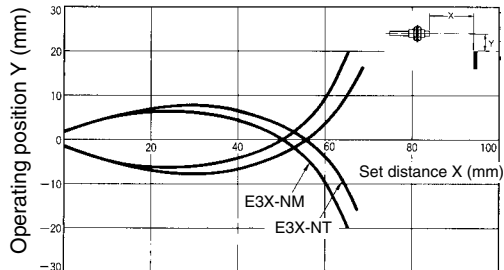

E32-L25

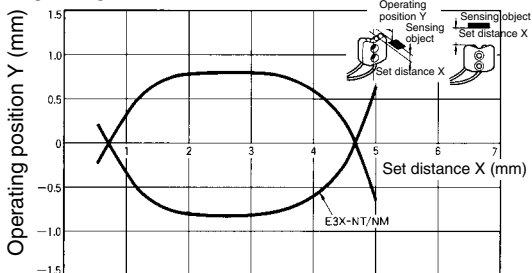

E32-L24L

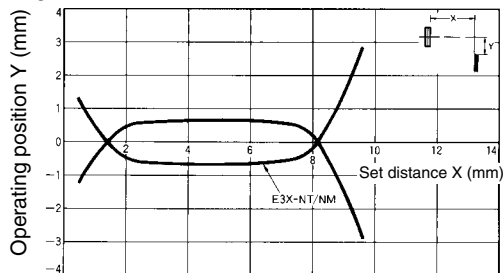



**Parallel Operating Range (Typical)**

At max. sensitivity.

The characteristics of the E3X-NV are the same as for the E3X-NT.

**E32-TC200**

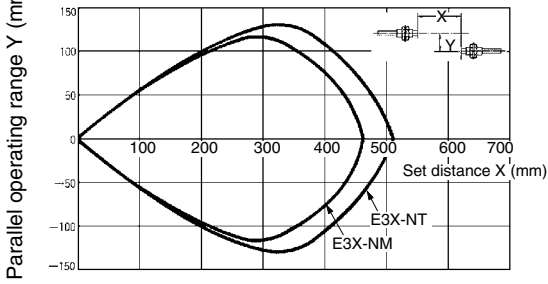

**E32-TC200+E39-F1**

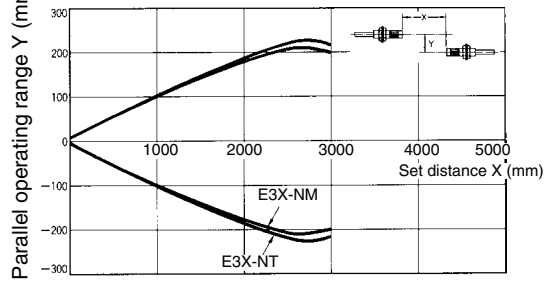

**E32-TC200+E39-F2**

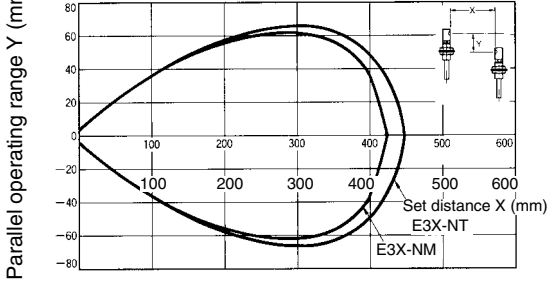

**E32-T11L**

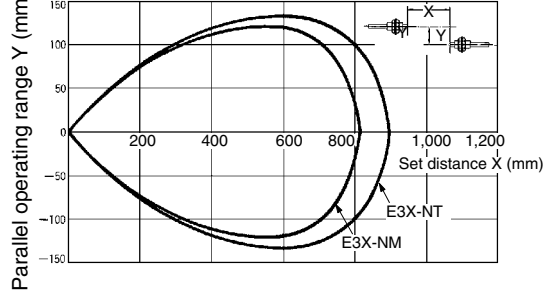

**E32-T11L with E39-F1**

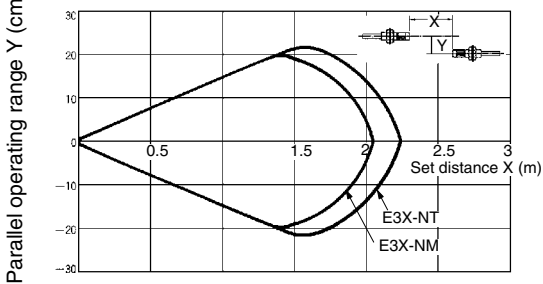

**E32-T11L with E39-F2**

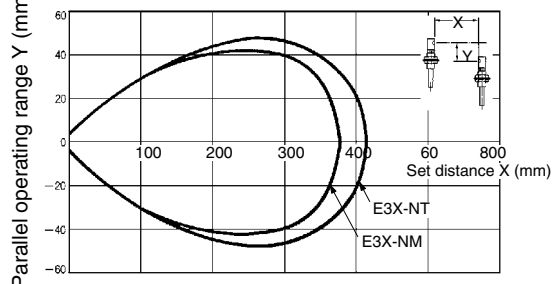

**E32-T21L**

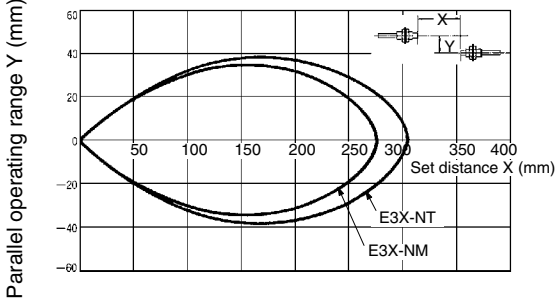

**E32-TC200E**

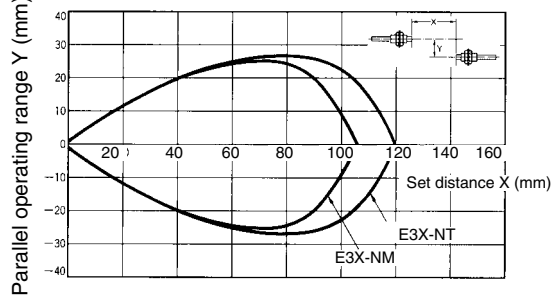

**E32-T11**

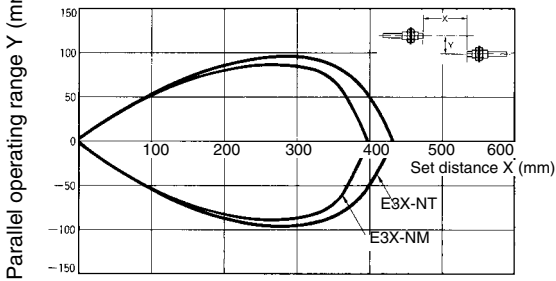

**E32-T11+E39-F1**

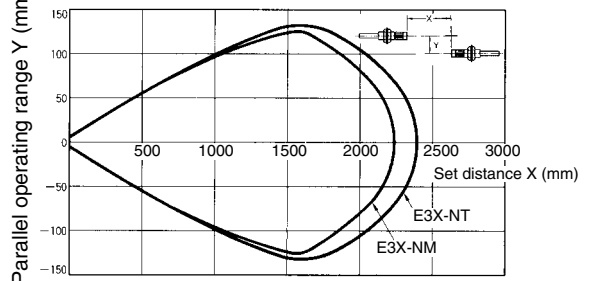

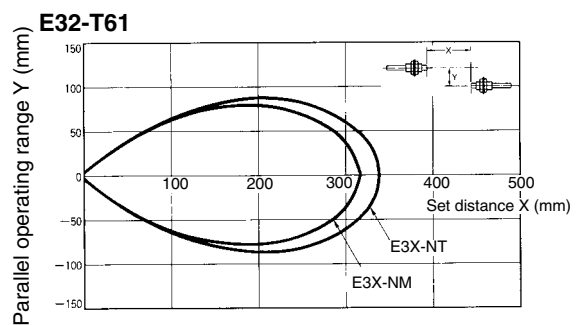
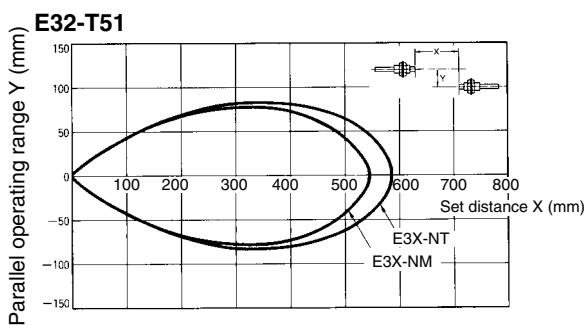
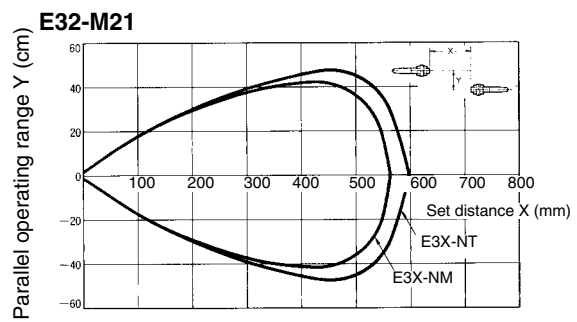
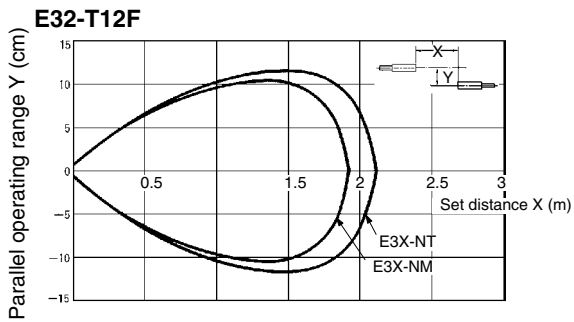
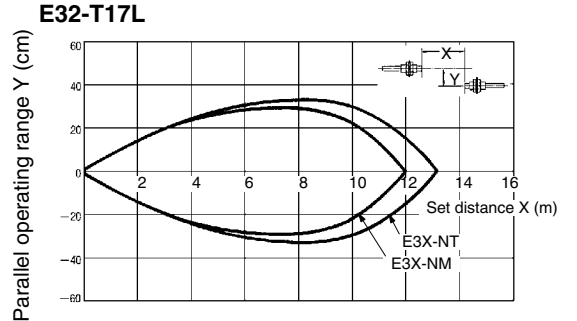
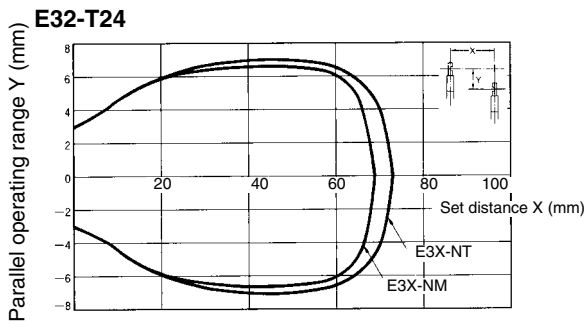
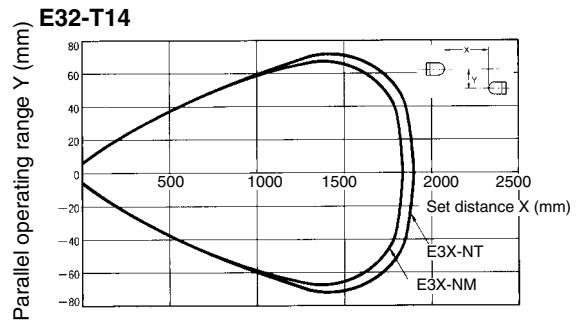
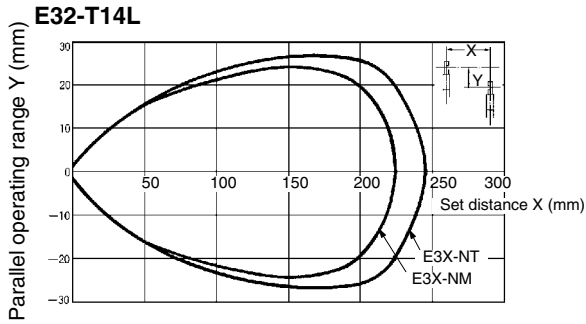
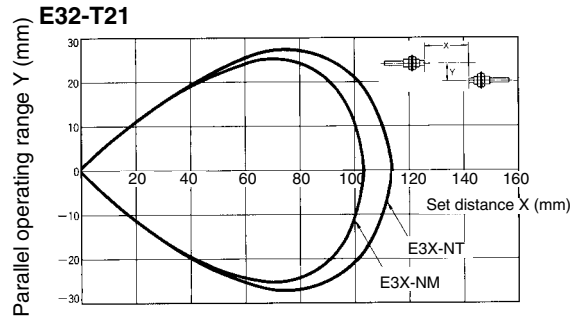
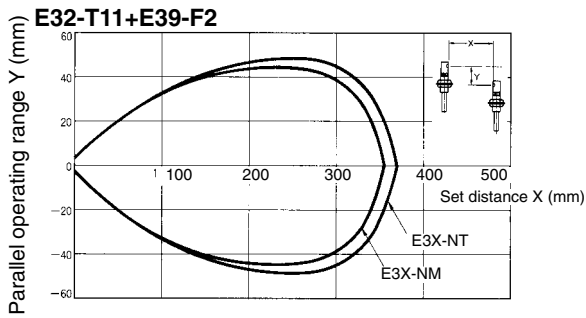

**E32-R21+E39-R3**

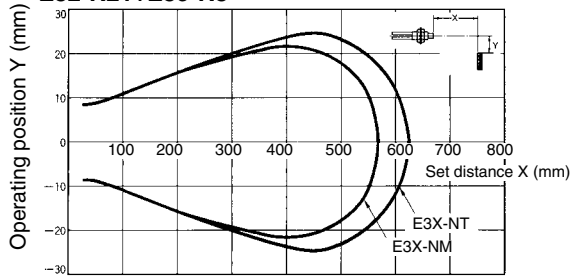

**E32-R16+E39-R1**

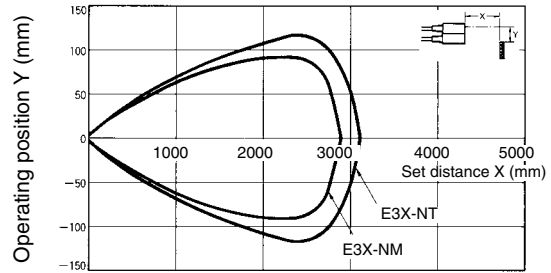

**E32-T22S**

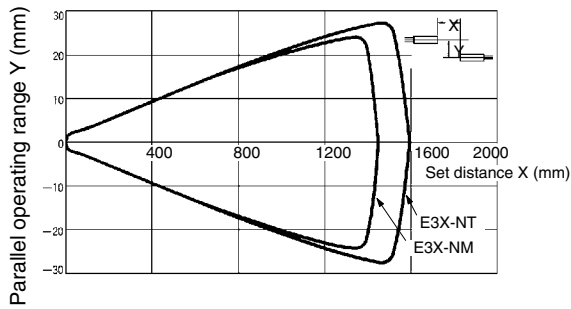

**E32-T24S**

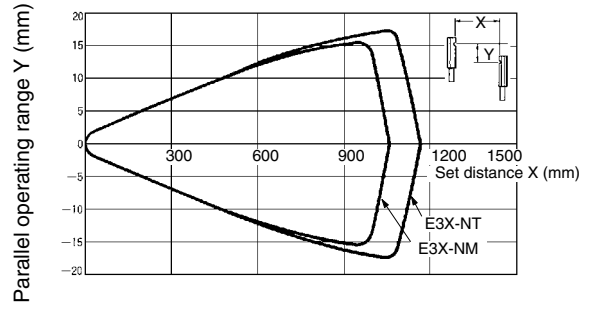

**E32-T16P**

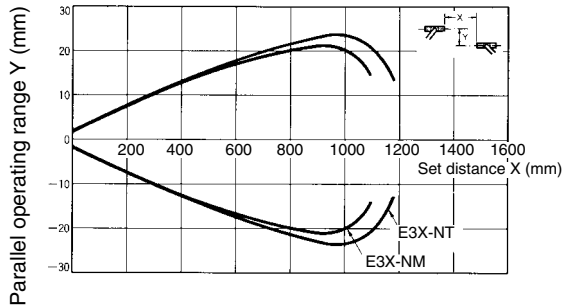

**E32-T16P**

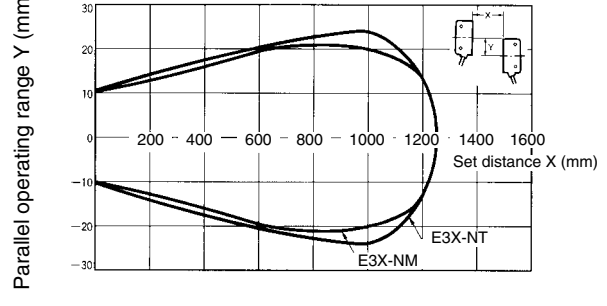

**E32-T54**

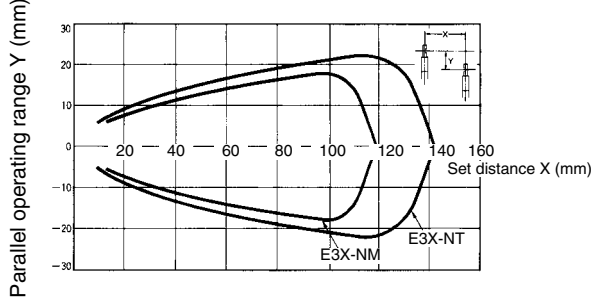

**E32-T14F**

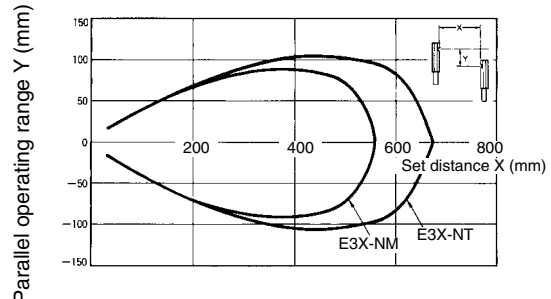

### ■ Sensing Objects vs. Operating Range (Typical)

The characteristics of the E3X-NV are the same as for the E3X-NT.

**E32-DC200 with E3X-NT11**

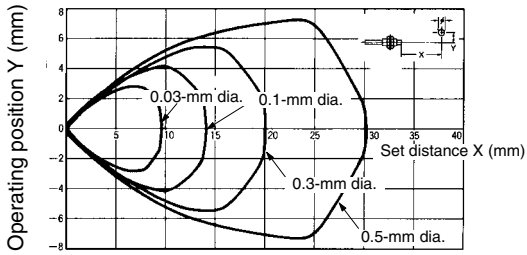

**E32-DC200 with E3X-NM11**

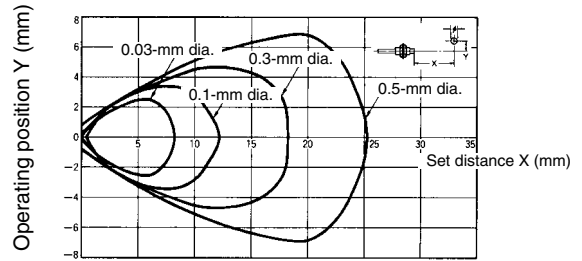

**E32-D22L with E3X-NT11**

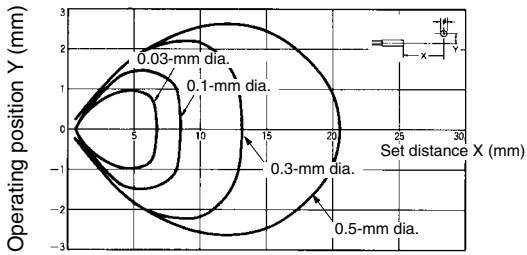

**E32-D22L with E3X-NM11**

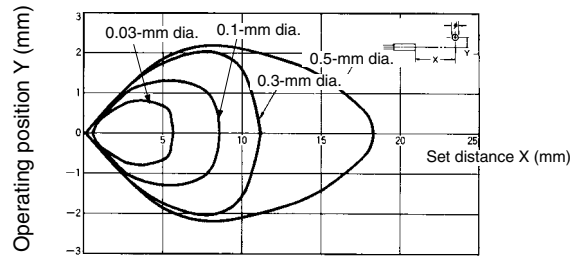

**E32-D11L with E3X-NT11**

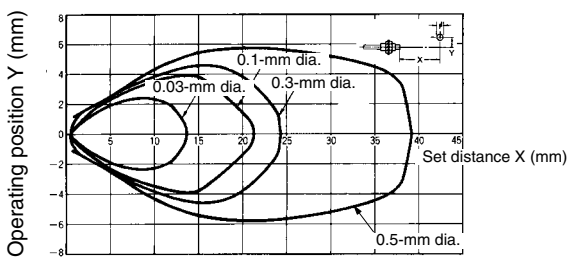

**E32-D11L with E3X-NM11**

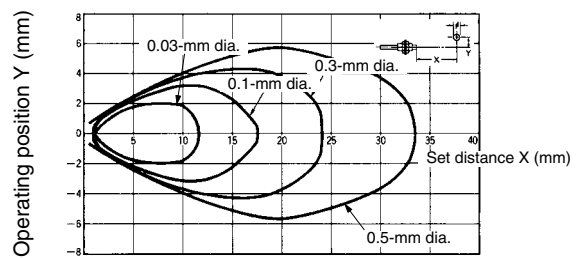

**E32-D33 with E3X-NT11**

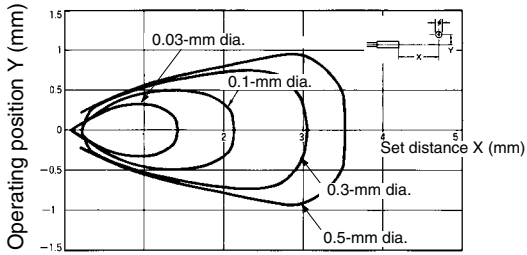

**E32-D33 with E3X-NM11**

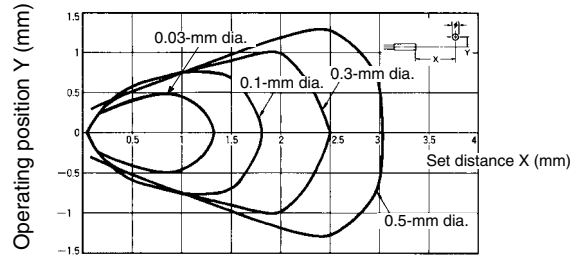

**E32-CC200 with E3X-NT11**

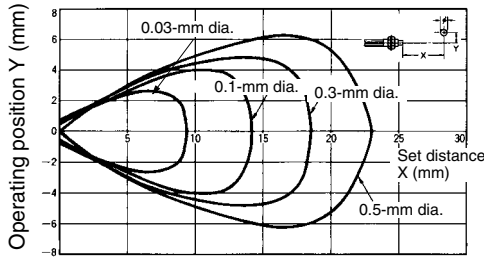

**E32-CC200 with E3X-NM11**

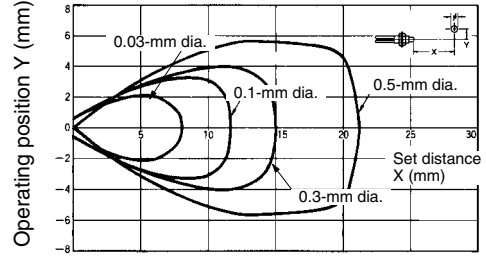

**E32-D32 with E3X-NT11**

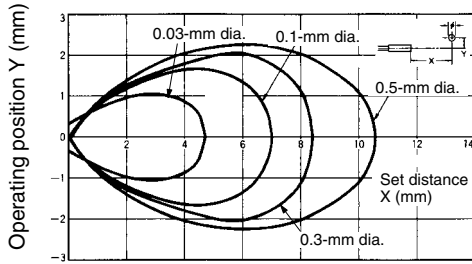

**E32-D32 with E3X-NM11**

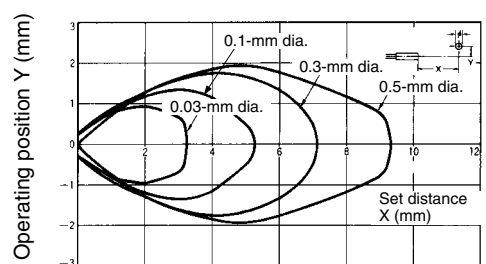

■ **Excess Gain vs. Sensing Distance (E3X-NVG)**

**E32-D11L**

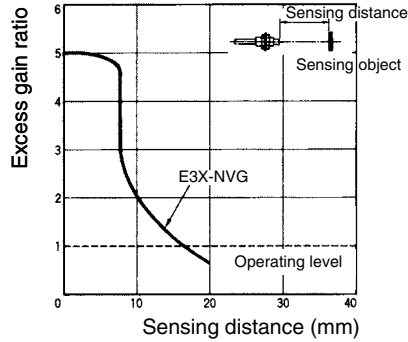

**E32-T11L, -T12L**

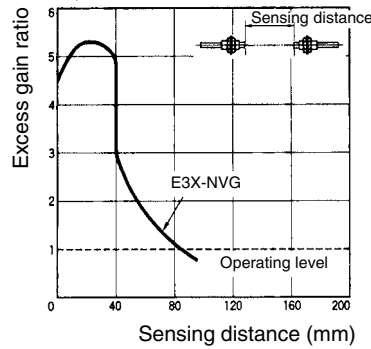

■ **Parallel Operating Range (E3X-NVG)**

**E32-T11L, -T12L**

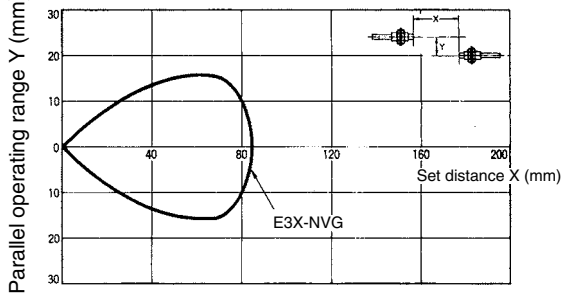

**E32-D11L**

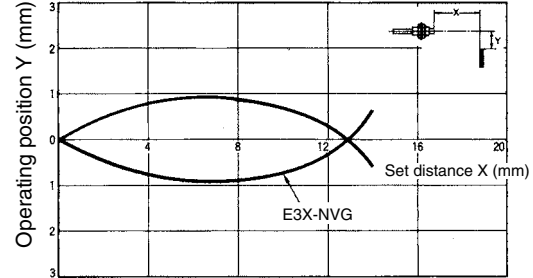

# Nomenclature

**E3X-NT11 (NPN)**  
**E3X-NT21 (NPN)**  
**E3X-NT41 (PNP)**  
**E3X-NT51 (PNP)**

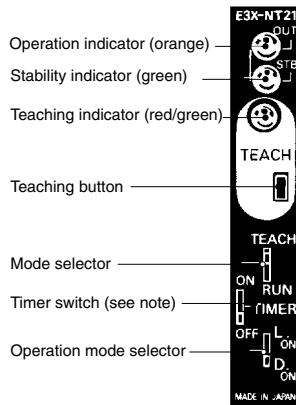

**E3X-NM11 (NPN)**  
**E3X-NM41 (PNP)**

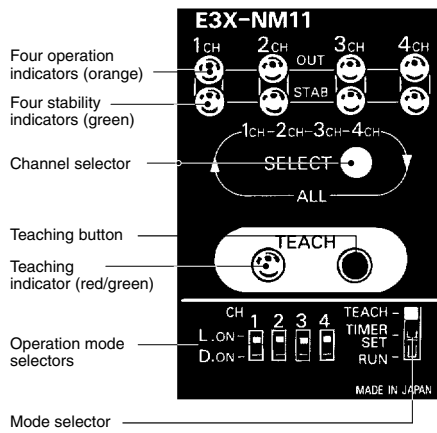

**E3X-NV21 (NPN)**  
**E3X-NVG21 (NPN)**

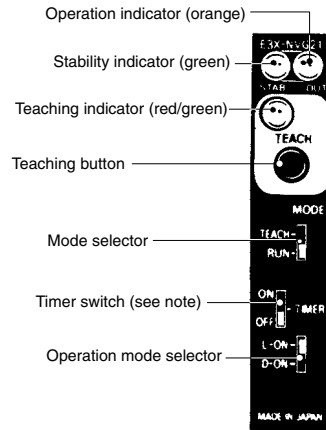

**Note:** The E3X-NT11 and E3X-NT41 do not have a timer function.

# Operation

## Output Circuits

**E3X-NT11**

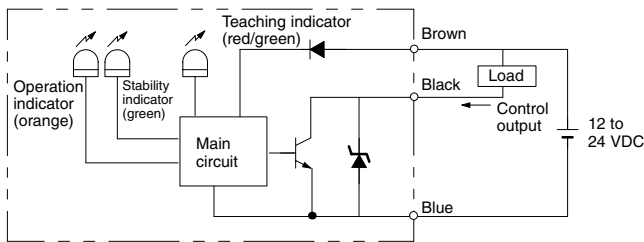

**E3X-NT21/E3X-NV21/E3X-NVG21**

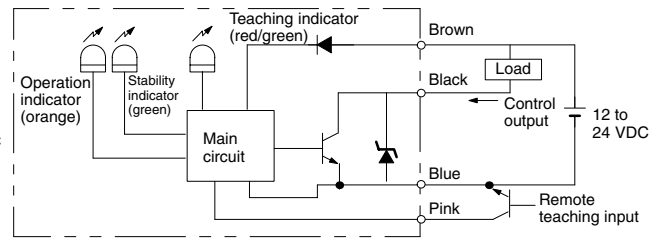

**E3X-NM11**

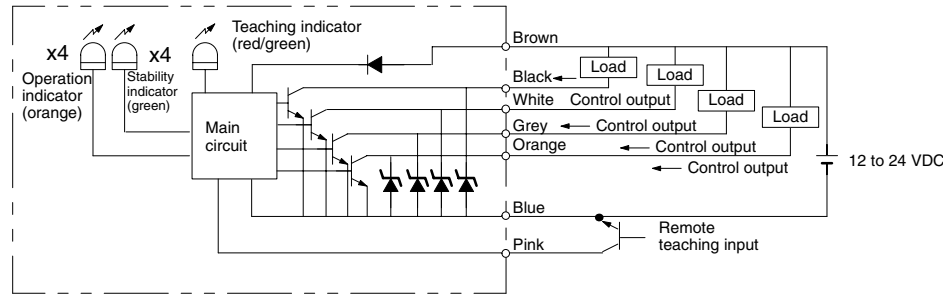

**E3X-NT41**

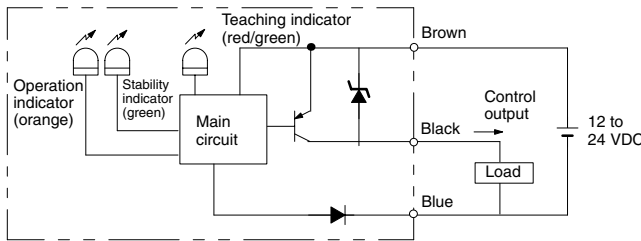

**E3X-NT51**

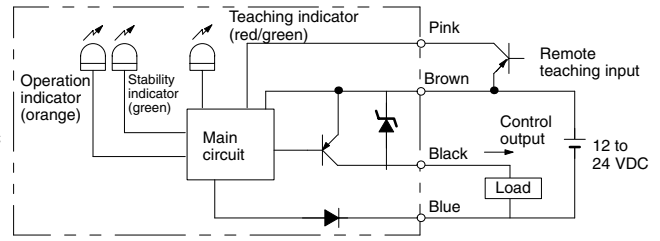

**E3X-NM41**

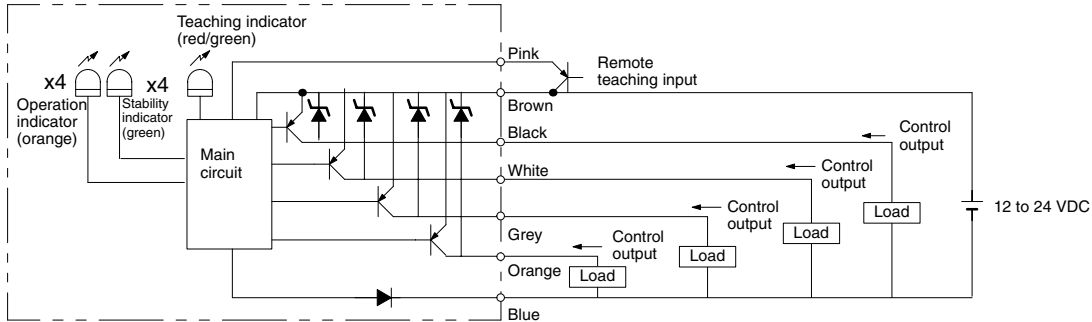

Channel no.	Control output wire color
1	Black
2	White
3	Grey
4	Orange

**■ With/Without-object Teaching, No-object Teaching, Maximum Sensitivity Setting**

Refer to the following table to select the most suitable sensitivity setting method.

Sensitivity setting method	Maximum sensitivity setting	No-object teaching	With/Without-object teaching
Typical application	Detection of the existence of objects that interrupt light perfectly Detection of objects with no background objects	If teaching is impossible by stopping the movement of sensing objects	Detection of a slight difference in reflection Color discrimination
		To detect bright or dark objects by teaching only with background objects	Background objects with unstable reflection Detection of object surface irregularities
		Elimination of background object influence	

- Note:**
1. None of the four channels has any output when the E3X-NM (four channels) is in teaching mode (i.e., all the four channels will be in teaching mode).
  2. If the set distance is very short (i.e., 0 to 12 mm for the E32-TC200 and 0 to 4 mm for the E32-DC200), no-object teaching is not possible due to excessive light, in which case, perform with/without-object teaching.
  3. In principle, use the E3X-NM (four channels) for the close connection of a maximum of four Fiber Units. When closely connecting two to three Fiber Units to more than one E3X-NT (one channel), perform with/without-object teaching, in which case teaching must be performed on a single E3X-NT at a time. Therefore, turn on only the E3X-NT on which teaching is performed. If all the E3X-NTs are turned on, interrupt the emitters of the Fiber Units on which teaching is not performed.

### ■ No-object Teaching with an Initial Operating Level Compensation Function With Through-beam (Dark-ON) Fiber Unit

1. Teaching button is pressed once.
2. The first sensing object is in the sensing area.

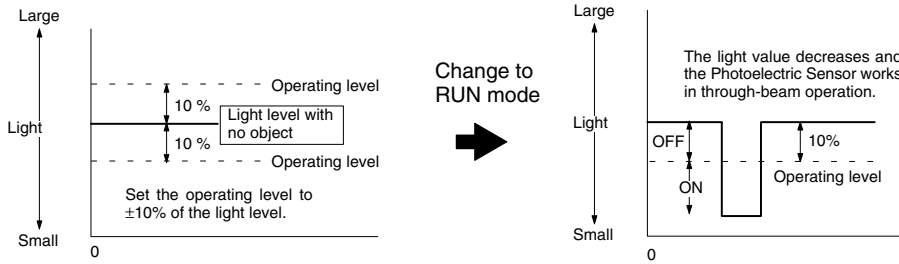

3. Sensing objects continue to pass through the sensing area.

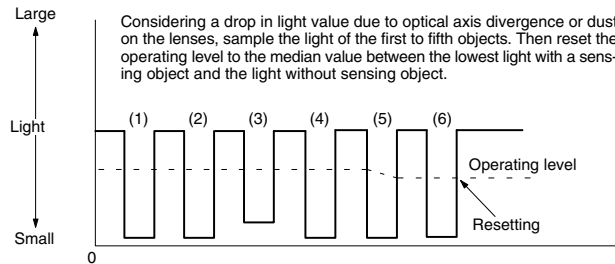

### With Reflective (Light-ON) Fiber Unit

1. Teaching button is pressed once.
2. The first sensing object is in the sensing area.

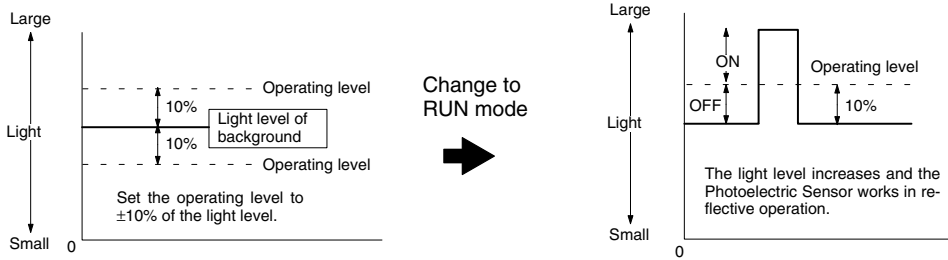

3. Sensing objects continue to pass through the sensing area.

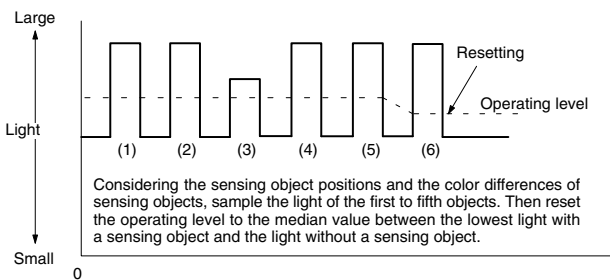

**Note:** If the light value up to the fifth object is at least twice as large as the operating level, the initial set operating level (10%) will be maintained.

- Note:**
1. After no-object teaching, when the E3X-N□ is turned off and on, the operation level will be set to the +10% of the initial light level (refer to the above (1)) in reflective operation and -10% of the initial light level in through-beam operation and stand by.
  2. After performing no-object teaching and changing to RUN mode, until the first sensing object is in the sensing area, the control output will be prohibited (OFF). The control output will be determined when the first sensing object is detected.
  3. The initial operating level compensation function will operate after teaching and/or after the E3X-N□ is turned on.
  4. During no-object teaching, after the E3X-N□ is in RUN mode, each channel requires approximately 60 ms to determine the operating level from the time the first sensing object is in the sensing area. Therefore, when using the E3X-NM (four channels), set an interval of 60 ms minimum for each channel if sensing objects are forwarded in sequence to the sensing area of each channel. After the operating level is determined, the E3X-NM will operate with a normal response speed of 500 μs.



### ■ Sensitivity Adjustment

#### Combination of the E3X-NT/E3X-NM and Fine Through-beam Fiber Units (E32-T22S/T24S/T84S)

##### No-object Teaching

Press the teaching button once with no wafer in the sensing area.

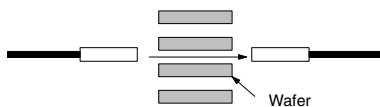

##### With/Without-object Teaching

Press the teaching button once with no wafer in the sensing area.

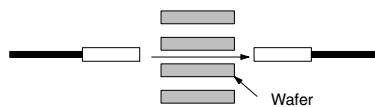

**Note:** If detection is not stable after no-object teaching, perform with/without-object teaching.

Press the teaching button once again with a wafer in the sensing area.

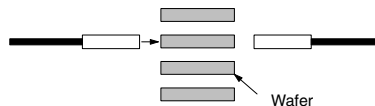







### Maximum Sensitivity Setting

**Note:** The sensitivity of the E3X-NT and E3X-NM are set to maximum before shipping. When resetting the sensitivity of the E3X-NT or E3X-NM to maximum after no-object teaching or with/without-object teaching, follow the steps described below.

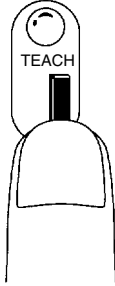
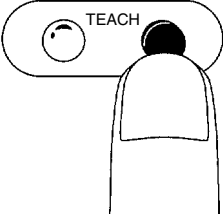
Procedure	Operation	E3X-NT	E3X-NM
1	Locate the sensor head within the rated sensing range with the E3X-N□.		
2	Set the mode selector to TEACH.		
3	The super-flashing function of the E3X-N□ will be activated. Therefore, adjust the optical axes so that the tip of the emitting fiber will be lit. If the optical axes are divergent, the tip of the emitting fiber will flash and the built-in buzzer of the E3X-N□ will beep.	---	
4	Press the teaching button for three seconds minimum with or without a sensing object. In the case of the E3X-NM, select a channel with the channel selector, at which time the stability indicator for the selected channel will flash. The teaching indicator (red) turns green. The built-in buzzer beeps once when the color of the teaching indicator is red. The built-in buzzer beeps continuously when the color of the teaching indicator is green. <b>Note:</b> The built-in buzzer will stop beeping when the teaching button is no longer being pressed.		
5	Set the mode selector to RUN to complete the sensitivity setting. The teaching indicator is OFF. <b>Note:</b> When the sensitivity is set to maximum, the sensitivity will be automatically adjusted regardless of the set distances of the fibers or light.		
6	Select the logical output required with the operation mode selector.		

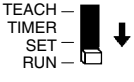
## No-object Teaching

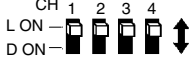
Procedure	Operation	E3X-NT	E3X-NM
1	Locate the sensor head within the rated sensing range with the E3X-N□.		
2	Set the mode selector to TEACH.		
3	The super-flashing function of the E3X-N□ will be activated. Therefore, adjust the optical axes so that the tip of the emitting fiber will be lit. If the optical axes are divergent, the tip of the emitting fiber will flash and the built-in buzzer of the E3X-N□ will beep.	---	
4	Press the teaching button for 0.5 to 2.5 seconds without a sensing object. In the case the E3X-NM, select a channel with the channel selector and press the teaching button, at which time the stability indicator for the selected channel will flash.  The teaching indicator (red) is lit.  The built-in buzzer beeps once.		
5	Set the mode selector to RUN. No-object teaching will be set when the first sensing object passes through the sensing area.  The teaching indicator (red) turns green (automatically turned off in one second).		
6	Select the logical output required with the operation mode selector.		

- Note:**
- To detect dark objects in front of bright backgrounds, set the operation mode selector to D. ON.
  - If the set distance is very short (i.e., 0 to 12 mm for the E32-TC200 and 0 to 4 mm for the E32-DC200), no-object teaching is not possible due to excessive light, in which case, perform with/without-object teaching.
  - If the teaching button is pressed for more than three seconds, the sensitivity of the E3X-N□ will be set to maximum, at which time the green indicator will be lit.
  - The E3X-N□ will be ready to detect objects in approximately one second after the mode selector is set to RUN.



## Remote Teaching/Timer Set Function



### Remote Teaching Function

In principle, the remote teaching function of the E3X-N□ should be used for initial teaching. Basically, the method of remote teaching is the same as that of sensitivity setting. In remote teaching, instead of pressing the teaching button, teaching is performed with a remote teaching input signal.

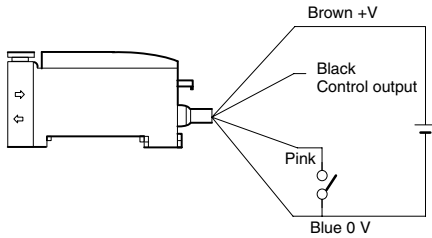
1. Set the mode selector to RUN.
2. The following signal conditions must be given as remote teaching input conditions.

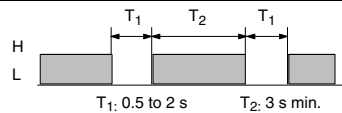
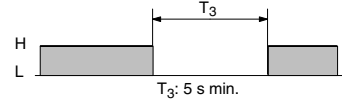
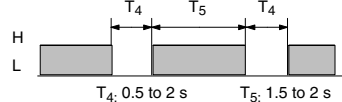

1. In the case of the E3X-NM, teaching is performed on all the four channels of the E3X-NM.
2. If all four channels are not used (e.g., only three channels are used), with/without-object teaching will not be available. In which case, perform the usual with/without-object teaching on the channels that are used instead of performing remote teaching.
3. If remote teaching is not performed, cut the pink wire at the base or connect the pink wire to the +V terminal.
4. After remote teaching input setting is finished, the E3X-N□ will be ready to detect objects in approximately one second.

<b>Power supply</b>		ON  OFF 
<b>Remote teaching input</b>	<b>With/Without-object teaching</b>	 <p>T<sub>1</sub>: 0.5 to 2 s    T<sub>2</sub>: 3 s min.</p>
	<b>Maximum sensitivity setting</b>	 <p>T<sub>3</sub>: 5 s min.</p>
	<b>No-object teaching</b>	 <p>T<sub>4</sub>: 0.5 to 2 s    T<sub>5</sub>: 1.5 to 2 s</p>

### Timer Set Function (E3X-NM)

1. Set the mode selector to TIMER SET.
2. Select a channel with the channel selector, at which time the stability indicator for the selected channel will flash.
3. The timer of the E3X-NM will be set by pressing the teaching button of the E3X-NM, at which time the operation indicator will be lit. When the teaching button is pressed again, the timer will be disabled and the operation indicator of the E3X-NM will be lit. To perform setting on other channels repeat procedures 2 and 3.
4. Set the mode selector to RUN.

**Note:** Channels are selected in the following order.

When all the channels are selected, it is possible to set the timer function on all channels.

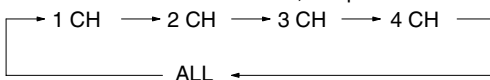

## ■ Optical Axis Adjustment (Super-flashing Function)

Set the mode selector of the E3X-N□ to TEACH. The super flashing function of E3X-N□ will be activated. When the optical axes of the fiber heads are divergent and the light value decreases by approximately 10% of the maximum value, the tip of the emitting fiber will start flashing and the built-in buzzer will beep. At this time, if the optical axes are divergent, adjust the axes. The peak light value will be memorized by the E3X-N□. Do not press the teaching button before or while adjusting the optical axes, otherwise, the super-flashing function will not operate.

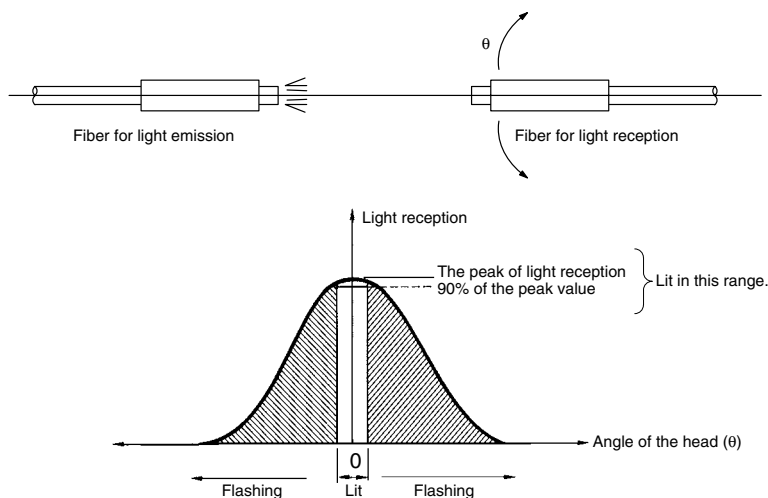

## ■ Special Fiber Units

The following special accessories are available (order separately). Contact your OMRON representative for the details.

### Fiber Units with Special Length of Stainless Steel Tube

Fiber with different lengths of stainless steel tubes are available.

#### Applicable Models

E32-TC200F (tube with 0.9-mm dia.)  
E32-TC200B/DC200F (tube with 1.2-mm dia.)  
E32-DC200B (tube with 2.5-mm dia.)

#### Appearance



The length can be ordered in increments of 10 mm between 10 mm min. and 120 mm max.

Tolerance:  $\pm 1.0$  mm if L is 40 mm or less. and  $\pm 2.0$  mm if L is more than 40 mm. (Note that standard Fiber Units have a 90-mm or 40-mm long stainless steel tube.)

### Fiber Units with 90° Bend in Stainless Steel Tube

#### Applicable Models

E32-TC200B/TC200F/DC200F

#### Appearance

#### Stainless Steel Tube with a 90° Bend at the Tip

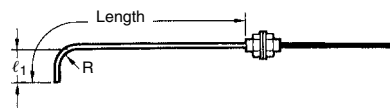

Bending radius	$\ell_1 (\pm 1)$	
R 5.0	10.0 mm	15.0 mm
R 7.5	12.5 mm	17.5 mm
R 10.0	15.0 mm	20.0 mm
R 12.5	17.5 mm	22.5 mm

The length overall is 120 mm max.

**Note:** If larger  $\ell_1$  is required, use the E39-F11 Sleeve Bender.

**Stainless Steel Tube with a 90° Bend at the Base**

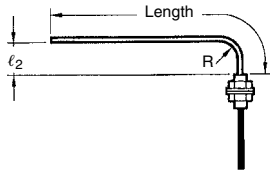

Bending radius	$l_1 (\pm 1)$	
R 5.0	5.0 mm	10.0 mm
R 7.5	7.5 mm	17.5 mm
R 10.0	10.0 mm	20.0 mm
R 12.5	12.5 mm	22.5 mm

The length overall is 120 mm max.

**Note:** If larger  $l_2$  is required, use the E39-F11 Sleeve Bender.

**Sensing Distance for Tubes with 90° Bends**

Model	Amplifier	Bending radius				
		Standard	R5.0	R7.5	R10.0	R12.5
E32-TC200B	E3X-NT	290 mm	180 mm	235 mm	255 mm	290 mm
	E3X-NM	270 mm	170 mm	220 mm	240 mm	270 mm
E32-TC200F	E3X-NT	70 mm	32 mm	70 mm	70 mm	70 mm
	E3X-NM	65 mm	30 mm	65 mm	65 mm	65 mm
E32-DC200F	E3X-NT	22 mm	16 mm	22 mm	22 mm	22 mm
	E3X-NM	20 mm	15 mm	20 mm	20 mm	20 mm

**Fiber Unit with Longer Fiber**

**Applicable Models**

- E32-TC200/-DC200
- E32-TC200B/-DC200B
- E32-TC200E/-DC200E
- E32-TC200F/-DC200F
- E32-TC200A

**Appearance**

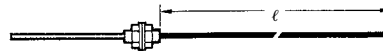

The length can be ordered in increments of 1 m between 6 m min. and 20 m max. (2 m and 5 m fiber length types are standard for E32-TC200, E32-DC200.)

**Fiber Length vs. Sensing Distance**

**Through-beam Fiber Unit**

(Based on the sensing distance using a fiber length of 2 m as 100%)

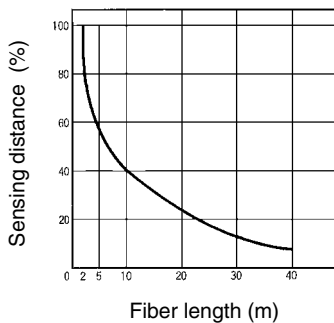

**Reflective Fiber Unit**

(Based on the sensing distance using a fiber length of 2 m as 100%)

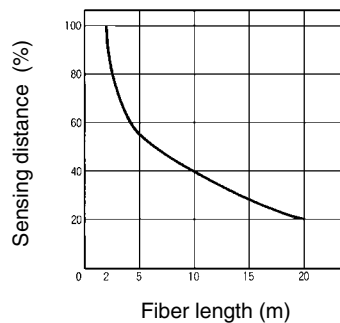

Changes in the Rated Sensing Distance

E32-TC200 with E3X-N□□□

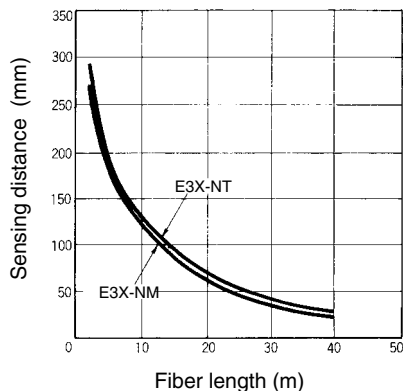

E32-DC200 with E3X-N□□□

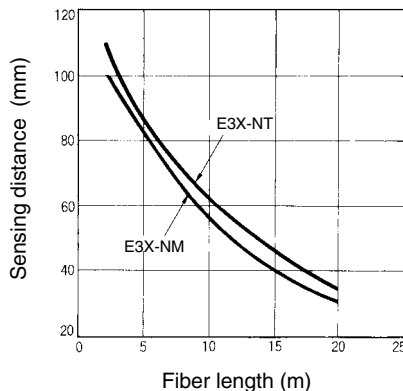

Dimensions

Note: All units are in millimeters unless otherwise indicated.

■ Amplifier

- E3X-NT11
- E3X-NT21
- E3X-NT41
- E3X-NT51

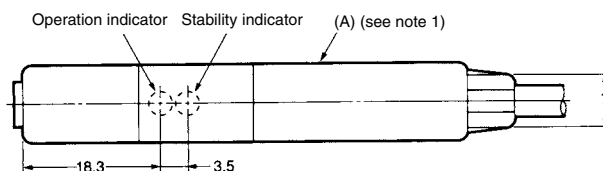
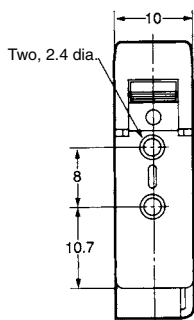
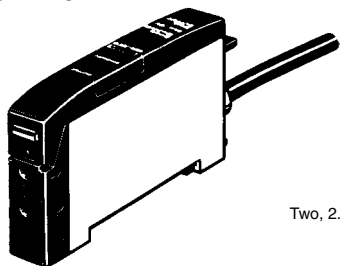

Note: The mounting bracket can be attached to this side.

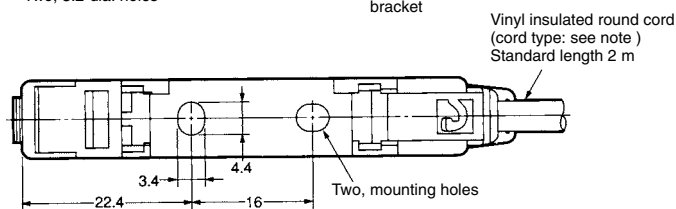
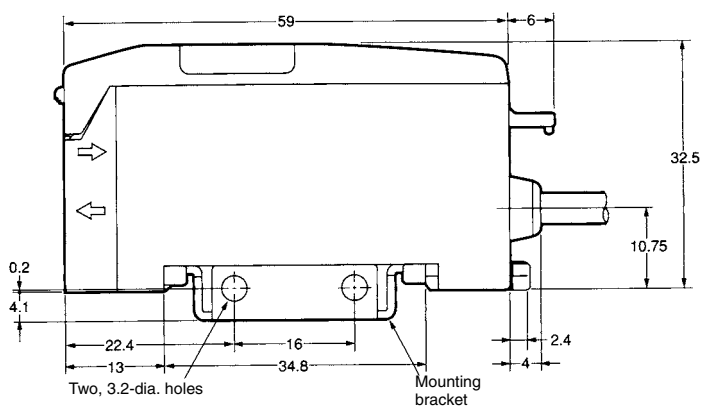

Note: The cord types are as follow:

- Cord: Polyvinyl chloride-covered cord
- E3X-NT11: 4-mm dia. (40/0.12 dia.), 3 cores
- E3X-NT21: 4-mm dia. (40/0.08 dia.), 4 cores
- E3X-NT41: 4-mm dia. (40/0.12 dia.), 3 cores
- E3X-NT51: 4-mm dia. (40/0.08 dia.), 4 cores
- Standard length: 2 m

Weight: Approx. 100 g





E3X-NV  
E3X-NVG

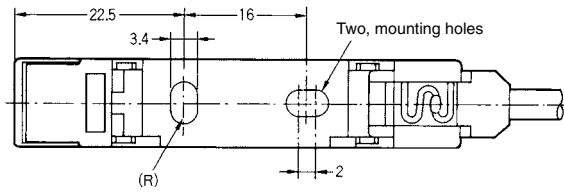
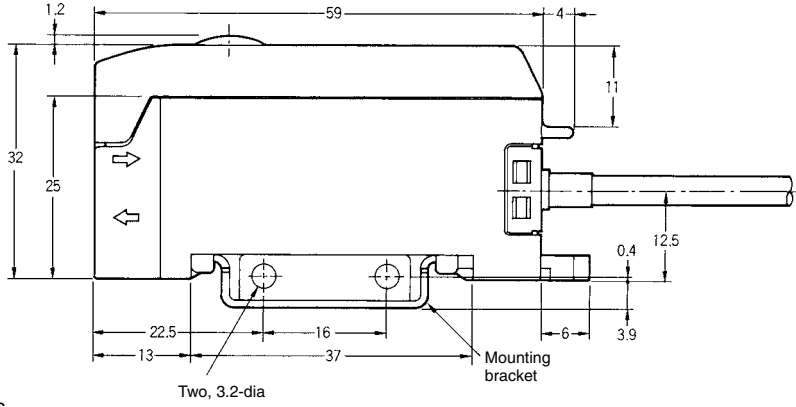
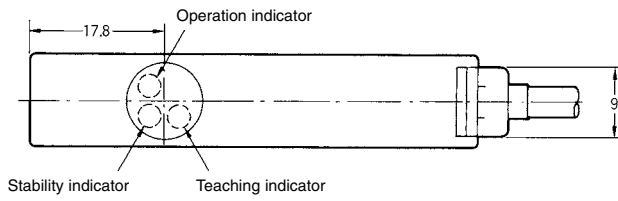
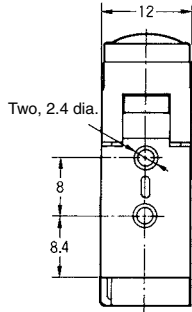
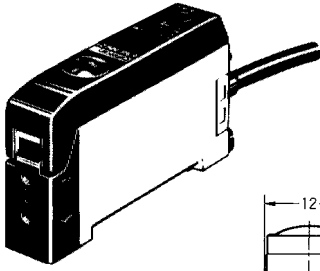

Cord: Polyvinyl chloride-covered cord  
4-mm dia. (40/0.08 dia.), 4 cores  
Standard length: 2 m

Weight: Approx. 100 g

■ Fiber Units

Through-beam (Sold in Pairs)

✂ Indicates models that allow free cutting. Models without this mark do not allow free cutting.

E32-T11L ✂

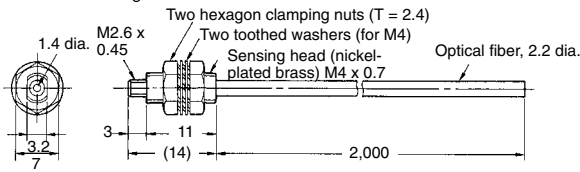

E32-T12L ✂

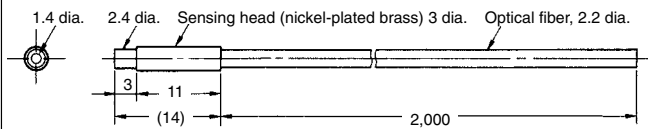

E32-T21L ✂

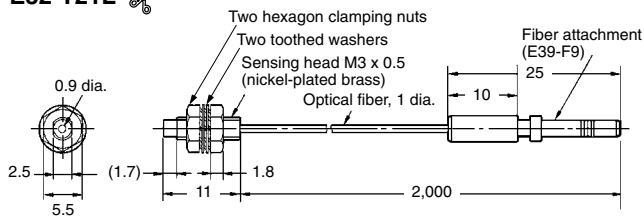

E32-T22L ✂

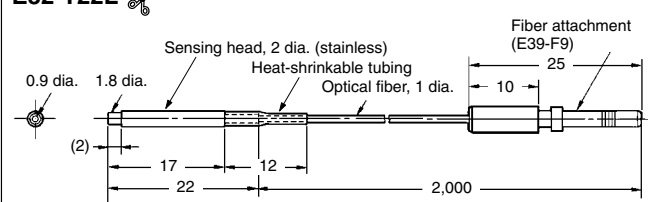

E32-TC200 ✂

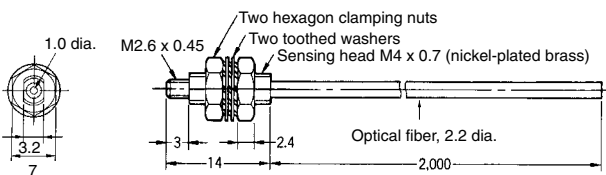

E32-TC200B  
E32-TC200B4 ✂

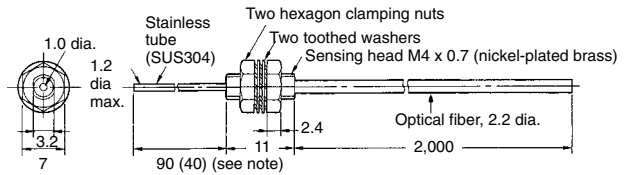

Note: The value in the parentheses is for the E32-TC200B4.

E32-T22 ✂

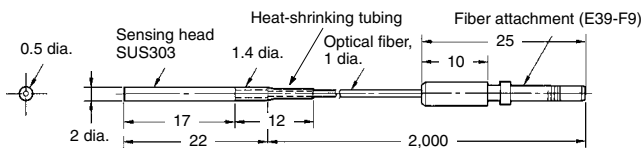

E32-TC200E ✂

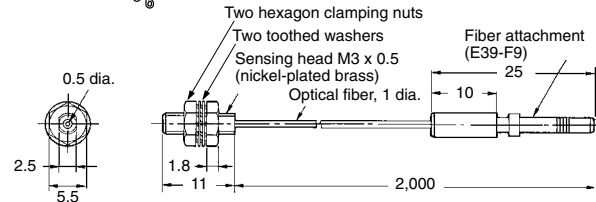

E32-TC200F  
E32-TC200F4 ✂

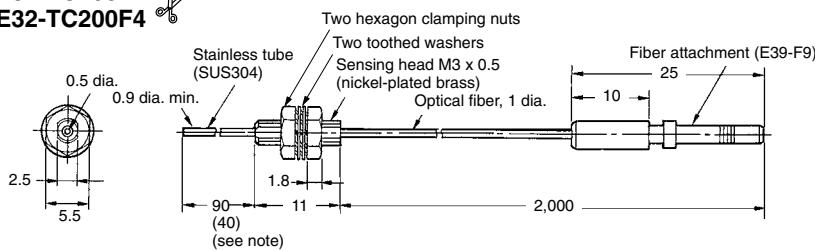

Note: The value in the parentheses is for the E32-TC200F4.

E32-TC200A ✂

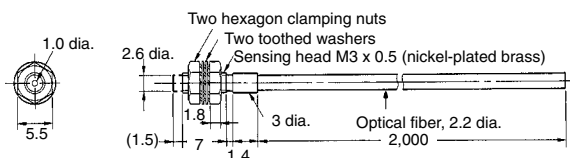

E32-T11 ✂

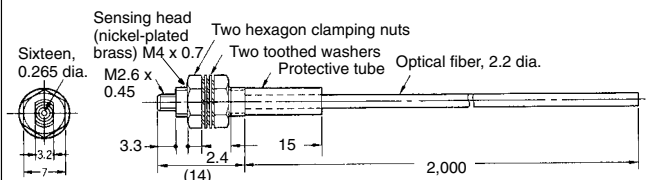

E32-T21

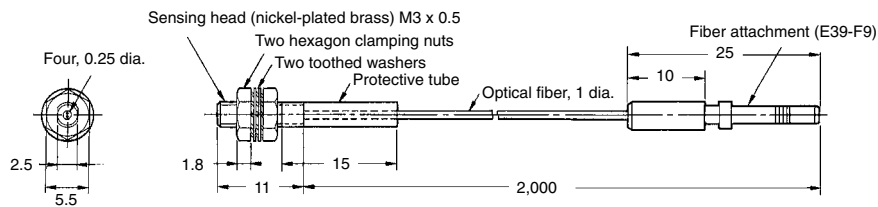

E32-TC200C

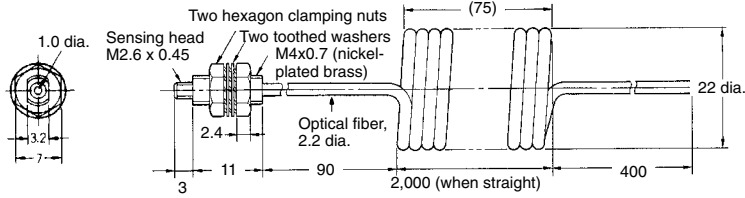

E32-TC200D  
E32-TC200D4

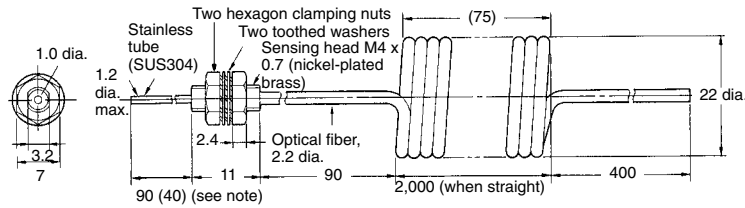

**Note:** The value in the parentheses is for the E32-TC200D4.

E32-T14L

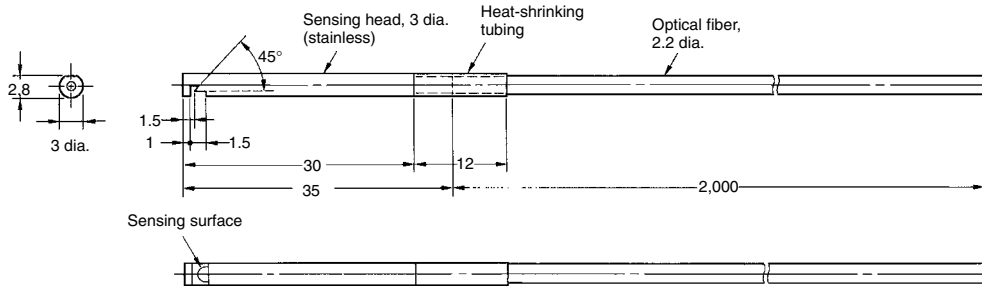

E32-T24

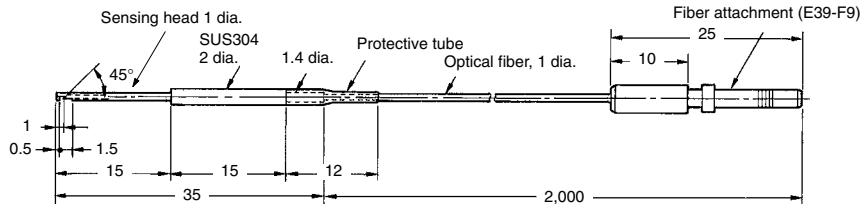

E32-T14

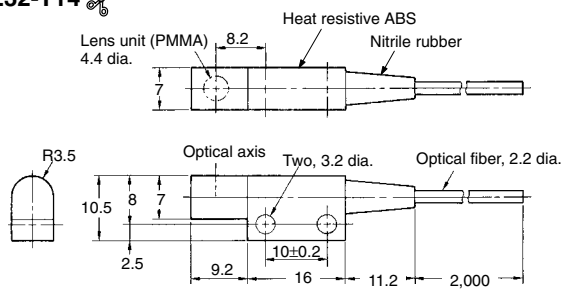

E32-T17L

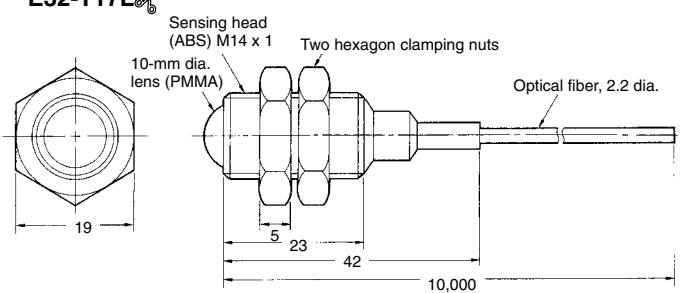

E32-T12F

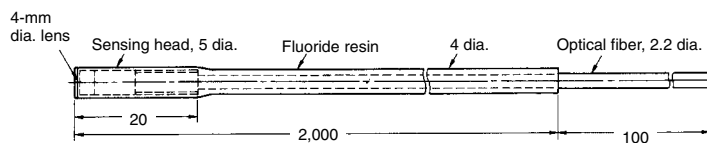

**E32-T14F**

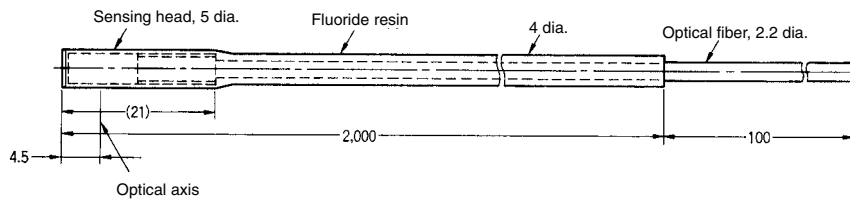

**E32-T16**

**Note:** The mounting bracket can also be used on surface (A).

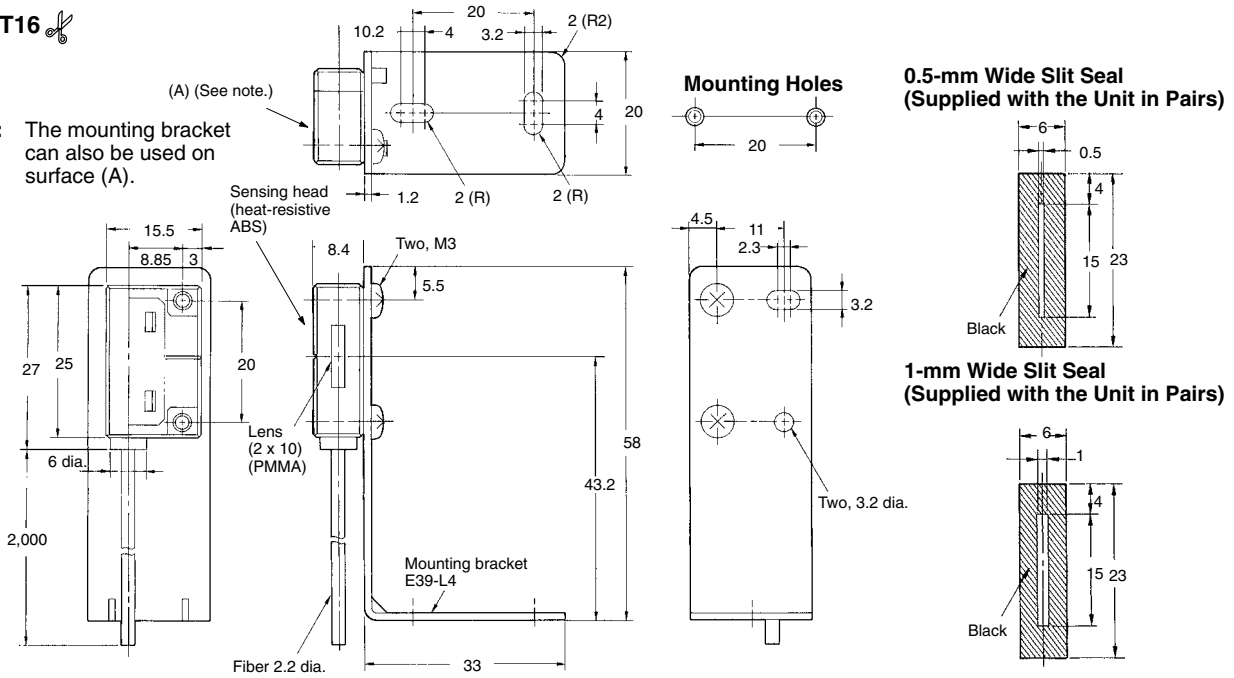

**E32-T16P**

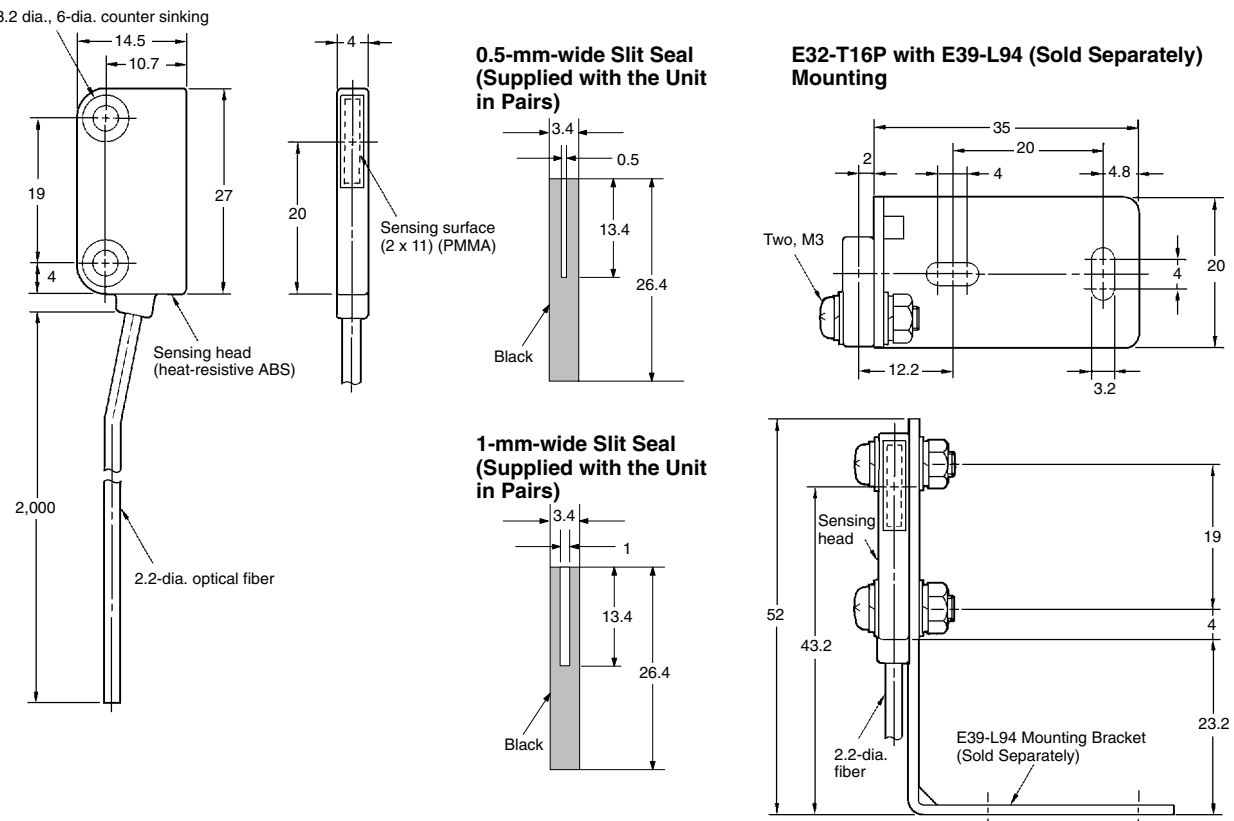

E32-M21

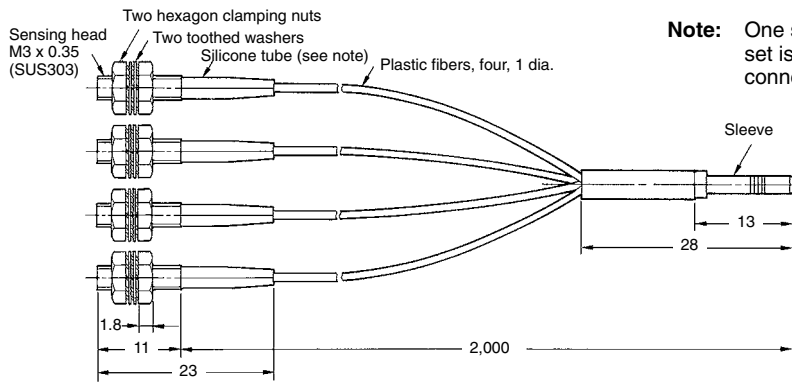

**Note:** One set of silicone tubes is black while the other set is grey for easy identification when they are connected to the emitter and receiver.

E32-T51

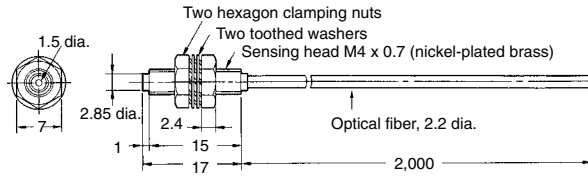

**Note:** Resistant temperature is 150°C.  
Resistant temperature is 130°C when used continuously.

E32-T54

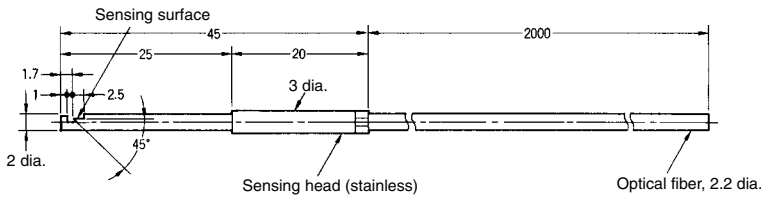

**Note:** Resistant temperature is 150°C.  
Resistant temperature is 130°C when used continuously.

E32-T61

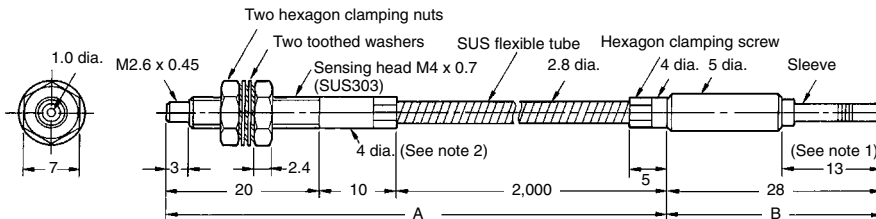

**Note:** 1. Section A resists 300°C and section B (which is inserted to the Amplifier) resists 110°C. The operating temperature of the section to be inserted into the Sensor must be within the operating temperature range of the Amplifier.  
2. 6 dia. for fibers of length 10 m or more.

Reflective

✂ Indicates models that allow free cutting. Models without this mark do not allow free cutting.

E32-D11L ✂

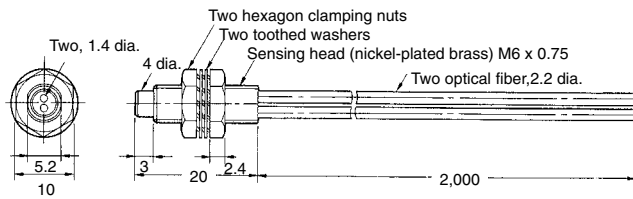

E32-D12 ✂

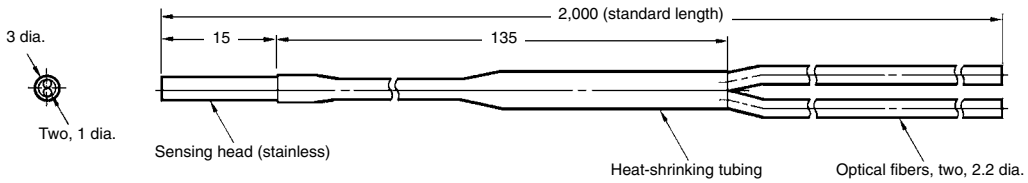

E32-D21L ✂

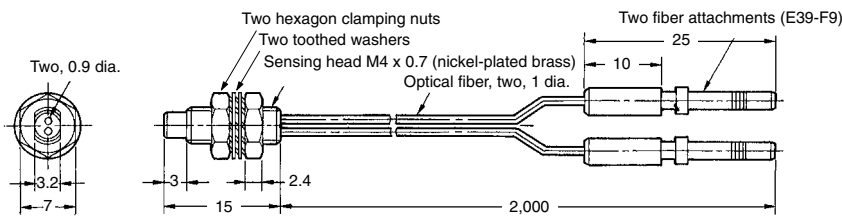

E32-D22L ✂

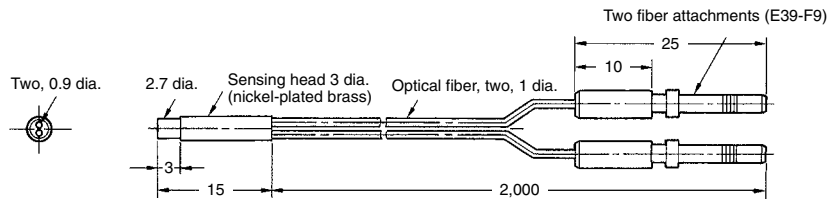

E32-DC200 ✂

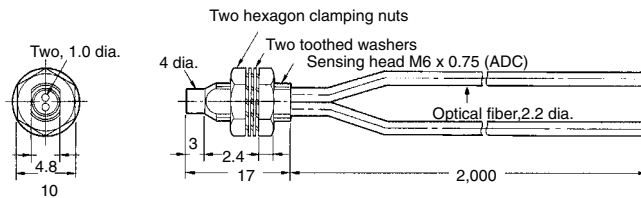

E32-DC200B  
E32-DC200B4 ✂

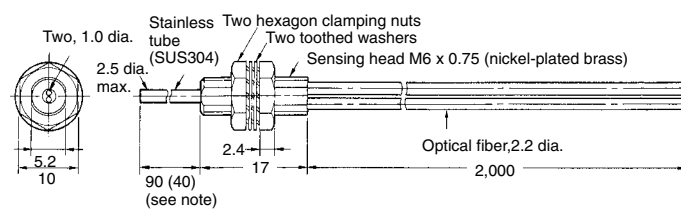

**Note:** The value in the parentheses is for the E32-DC200B4.

E32-DC200E ✂

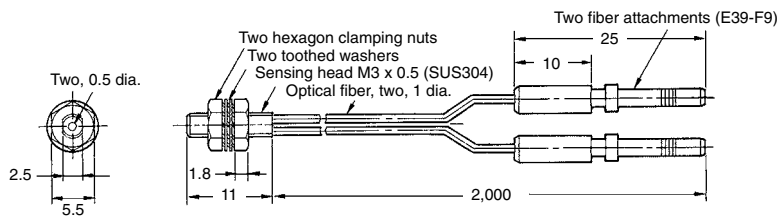

**E32-DC200F**  
**E32-DC200F4**

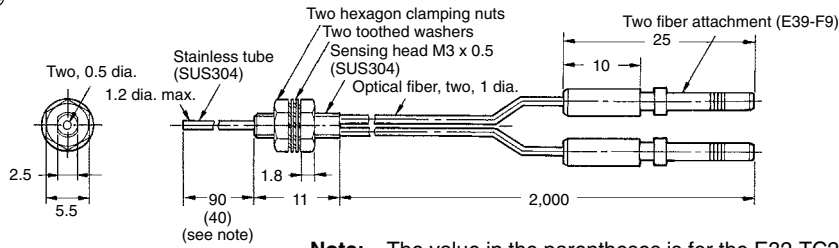

**Note:** The value in the parentheses is for the E32-TC200F4.

**E32-D11**

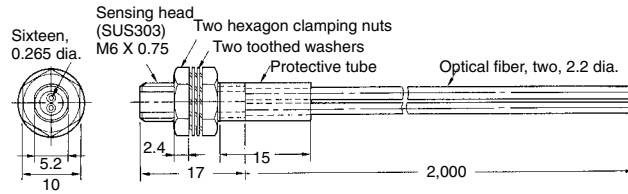

**E32-D21**

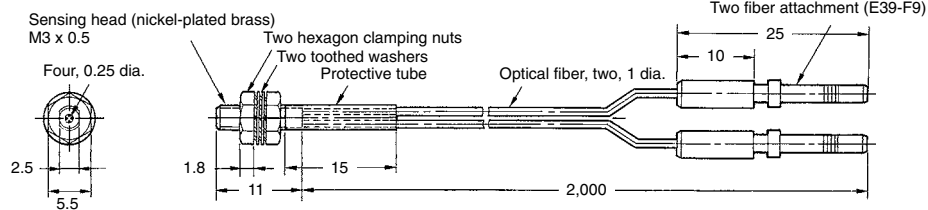

**E32-D33**

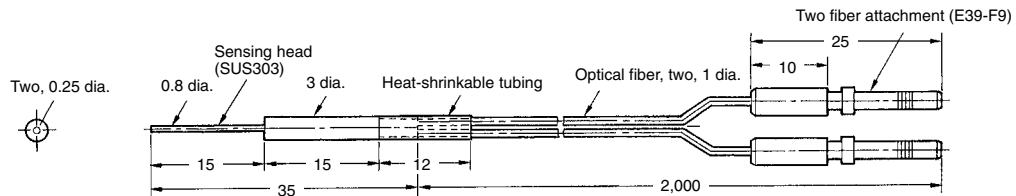

**E32-CC200**

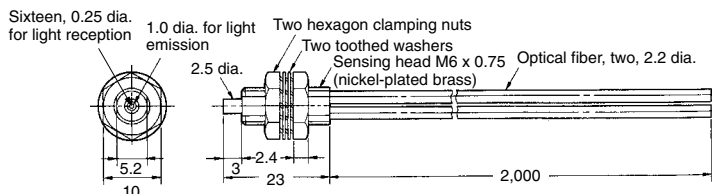

**Note:** The fiber for the emitter is identified by a white line.

**E32-D32**

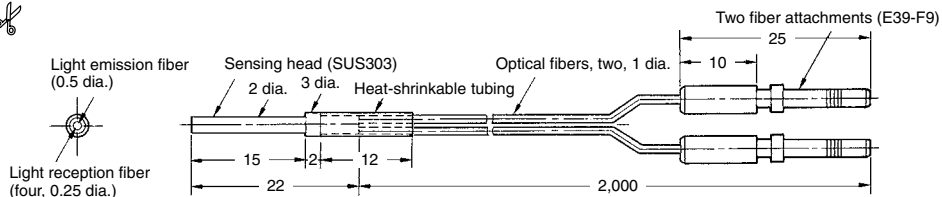

**Note:** The fiber for the emitter is identified by a white line.

**E32-D32L**

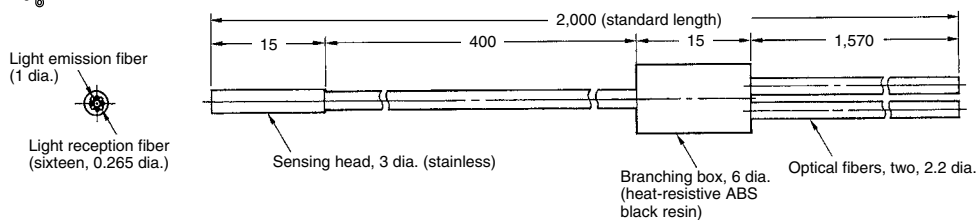

E32-D14L

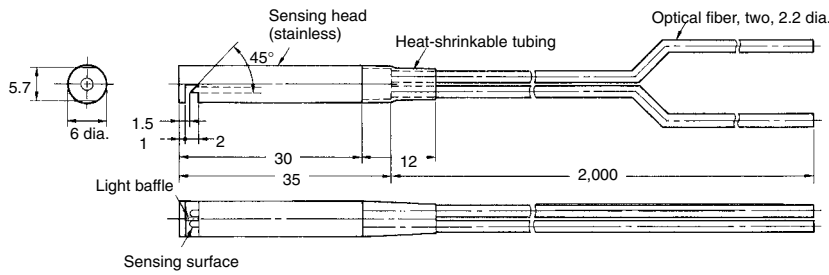

E32-D24

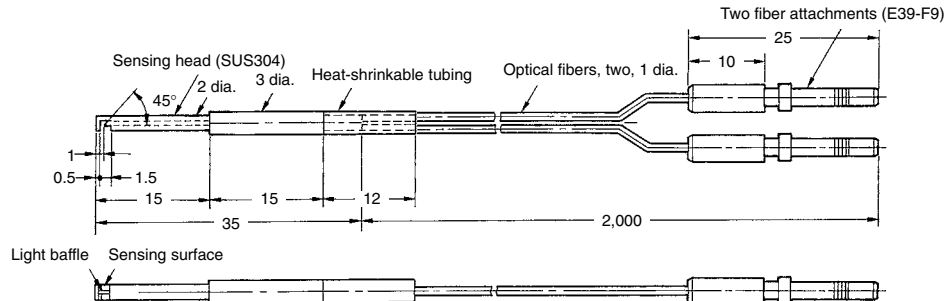

E32-D12F

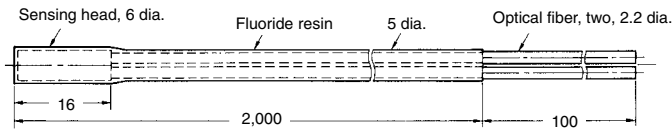

E32-D51

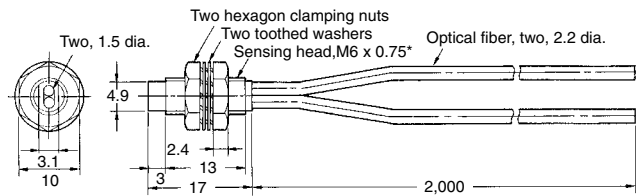

\*nickel-plated brass

**Note:** Resistant temperature is 150°C.  
Resistant temperature is 130°C  
when used continuously.

E32-D61

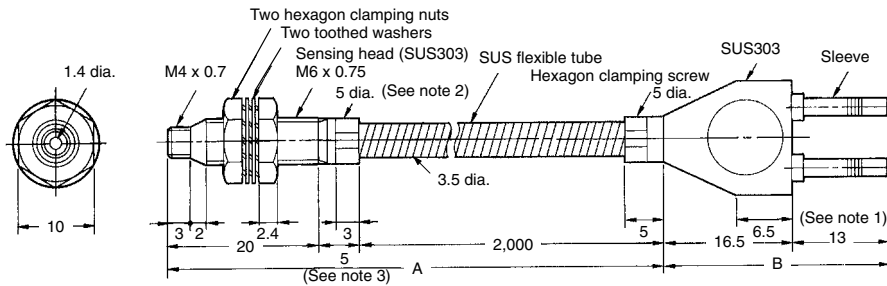

**Note:** 1. Section A resists 300°C and section B (which is inserted to the Amplifier) resists 110°C. The operating temperature of the section to be inserted into the Sensor must be within the operating temperature range of the Amplifier.

- 2. 6 dia. for fibers of length 10 m or more.
- 3. 10 dia. for fibers of length 10 m or more.

E32-D73

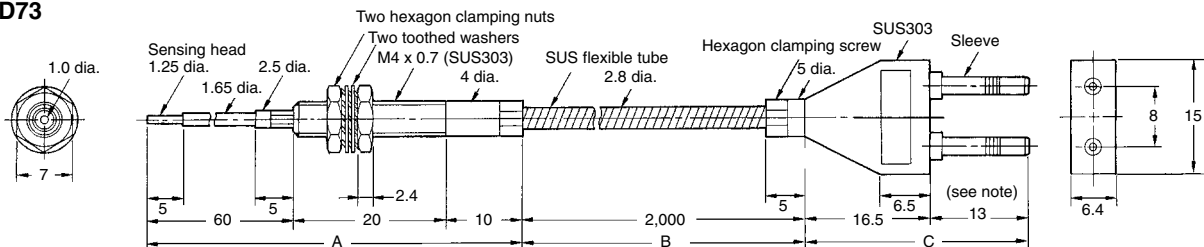

**Note:** Section A resists 400°C, section B resists 300°C, and section C (which is inserted to the Amplifier) resists 110°C. The operating temperature of the section to be inserted into the Sensor must be within the operating temperature range of the Amplifier.



**E32-R21**  
**(One E39-R3**  
**Reflector is**  
**supplied with**  
**the Sensor)**

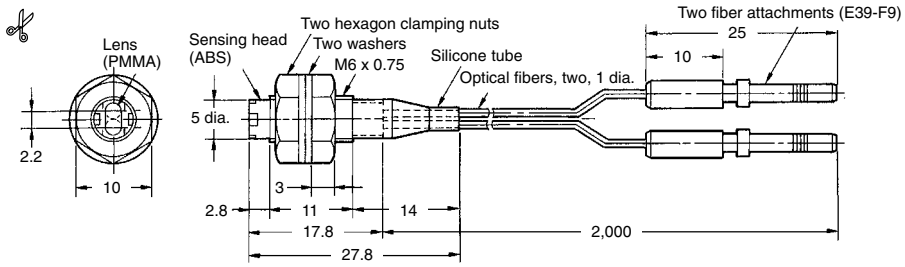

**E32-R16**  
**(One E39-R1**  
**Reflector is**  
**supplied with**  
**the Sensor)**

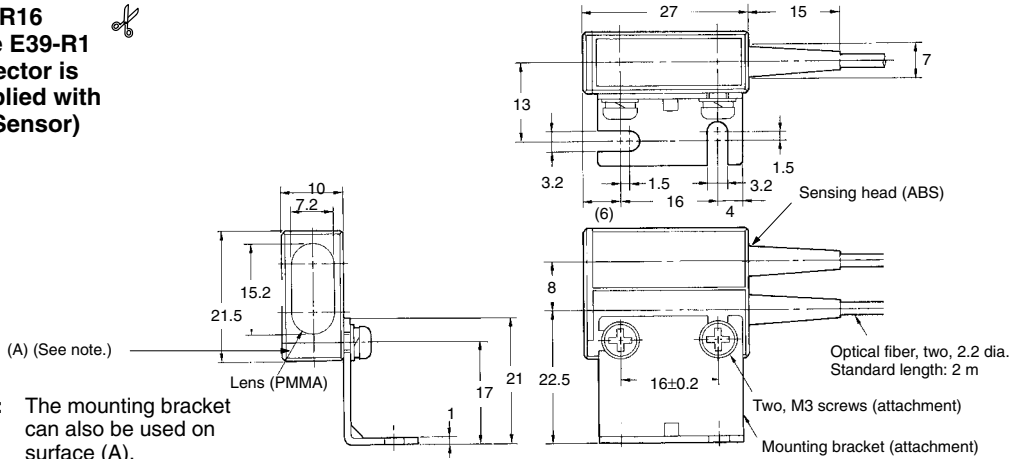

**Note:** The mounting bracket can also be used on surface (A).

**E32-L25**

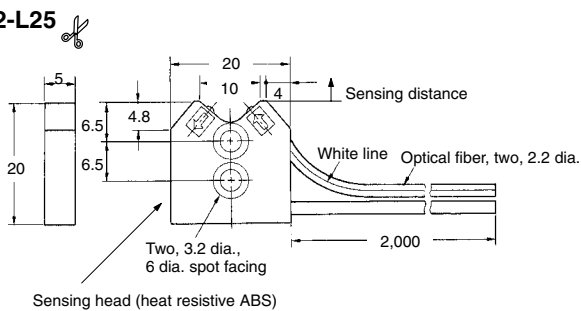

**Note:** The fiber for the emitter is identified by a white line.

**E32-L25A**

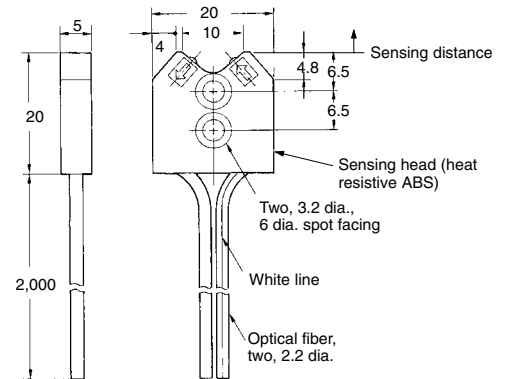

**E32-L25L**

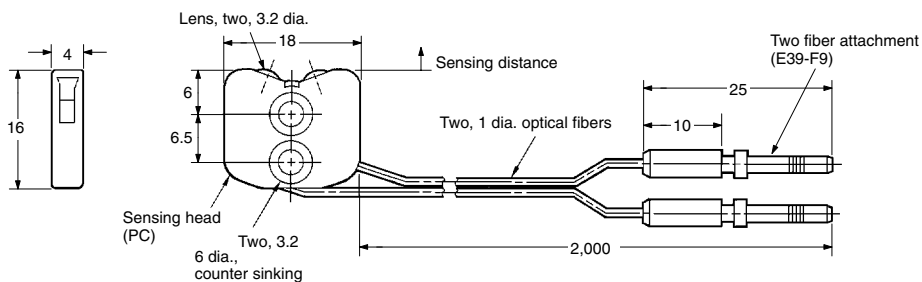

**E32-L24L**

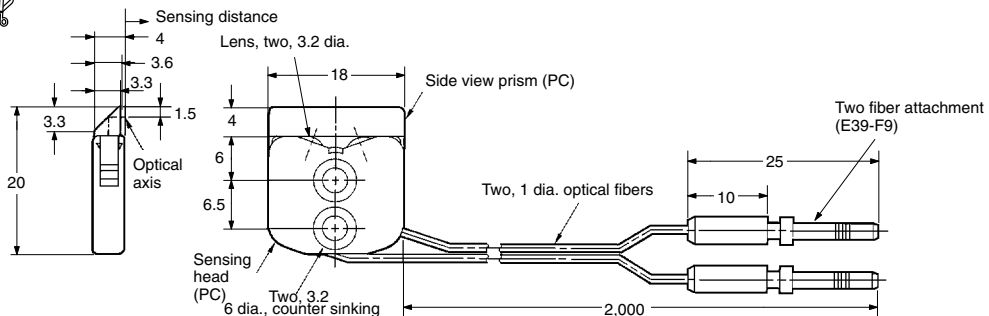

**Fine Through-beam**

✂ Indicates models that allow free cutting. Models without this mark do not allow free cutting.

**E32-T22S** ✂

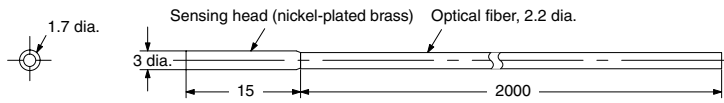

**E32-T24S** ✂

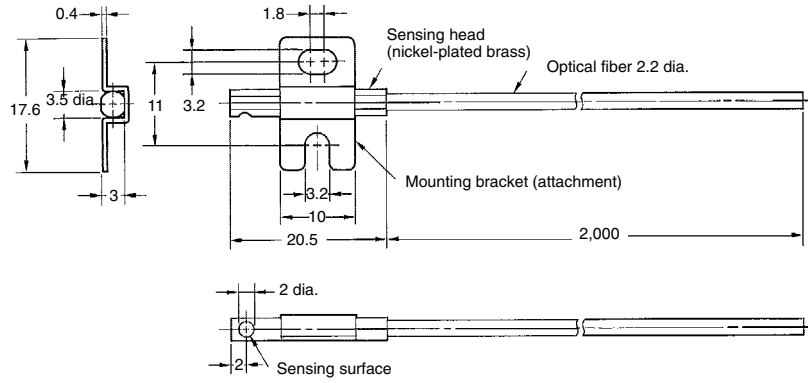

**E32-T84S** ✂

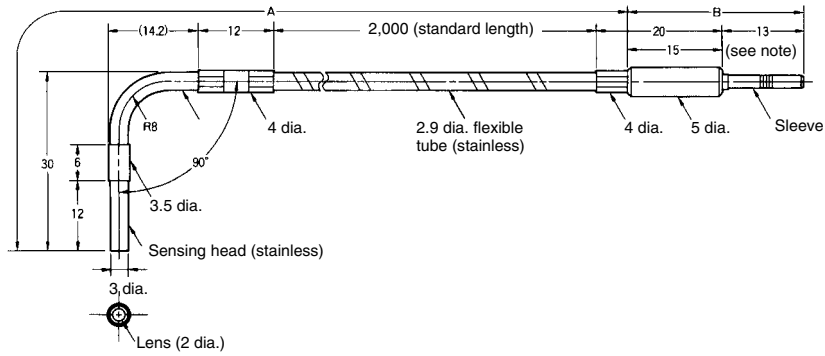

**Note:** Section A resists 200°C and section B (which is inserted to the Amplifier) resists 110°C. The operating temperature of section to be inserted into the Sensor must be within the operating temperature range of the Amplifier.

**Slot Fiber Units**

**E32-G14** ✂

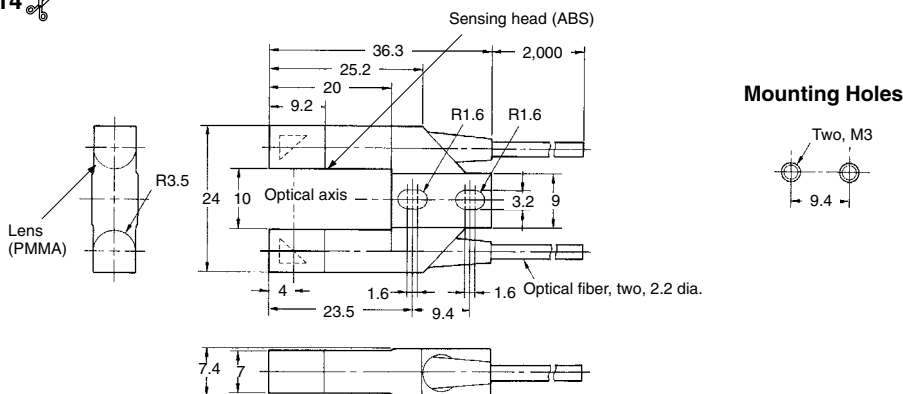

■ Reflector

Reflector (Miniature)  
E39-R3

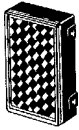

**Note:** Mounting bracket is attached.

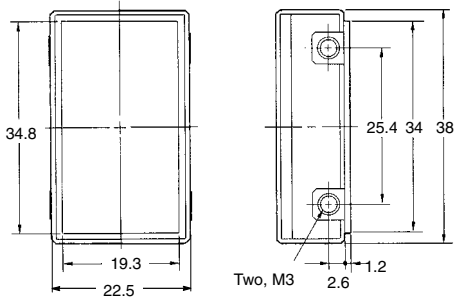

Reflector  
E39-R1

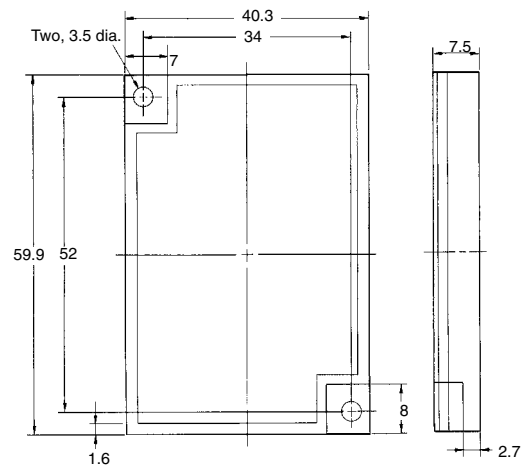

■ Attachments

E39-F1  
Long Distance Lens Unit

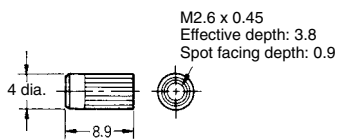

**Note:** One set includes two units.

E39-F2  
Side-view Unit

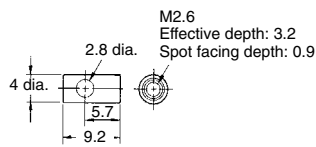

**Note:** One set includes two units.

E39-F3  
Lens-equipped Reflective Unit

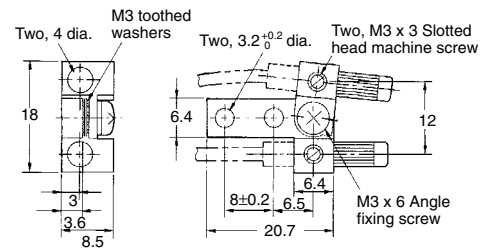

E39-F5  
Side-view Reflective Unit

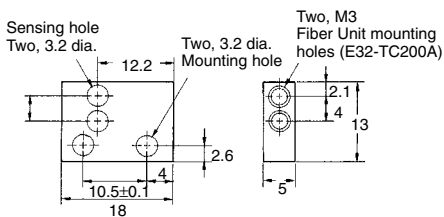

**Note:** When mounting, remove all of the accompanying screws first and then screw the E32-TC200A into the E39-F5 until the stopper comes into contact.

E39-F3A  
Small Spot Lens Unit

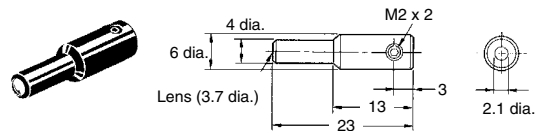

■ Protective Spiral Tubes

E39-F32A, E39-F32A5  
E39-F32B, E39-F32B5

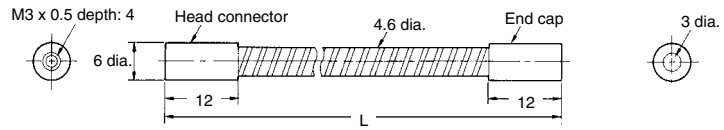
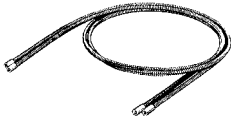

- Note:**
1. L is as follows:  
E39-F32A and E39-F32B: 1,000  
E39-F32A5, E39-F32B5: 500
  2. A pair of E39-F32A(5)'s is sold as E39-F32B(5).

E39-F32C, E39-F32C5

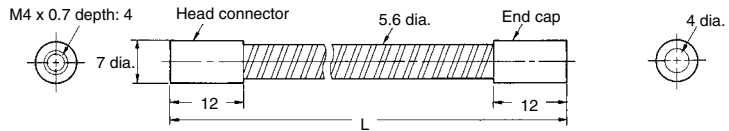

- Note:** L is as follows:  
E39-F32C: 1,000  
E39-F32C5: 500

E39-F32D, E39-F32D5

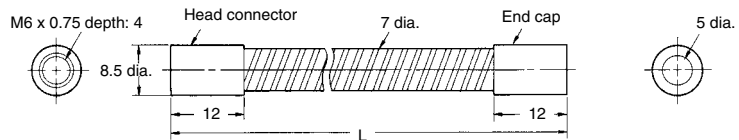
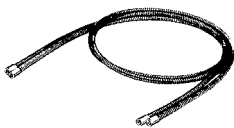

- Note:** L is as follows:  
E39-F32D: 1,000  
E39-F32D5: 500

■ Accessories

E39-F4 Fiber Cutter

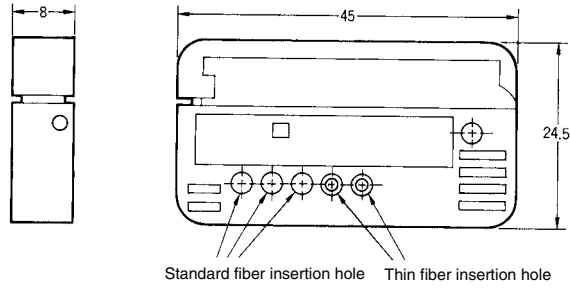
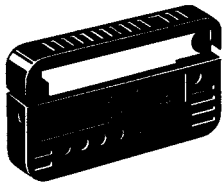

E39-F9 Attachment for Thin Fiber

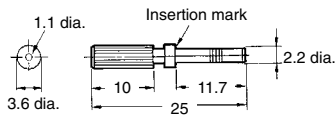
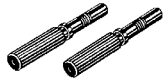

Note: One set includes two units.

E39-F10 Fiber Connector

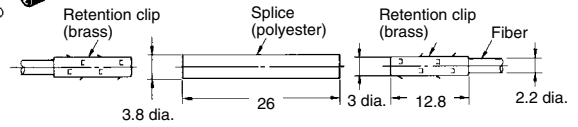
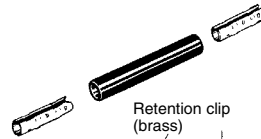

E39-G10 Protective Cover

Note: This Cover is for the E3X-NT Amplifier Unit.

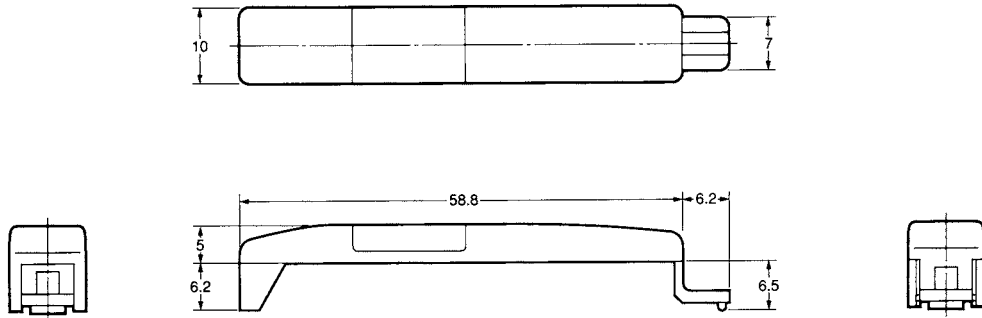

E39-G9 Protective Cover

Note: This Cover is for the E3X-NM Amplifier Unit.

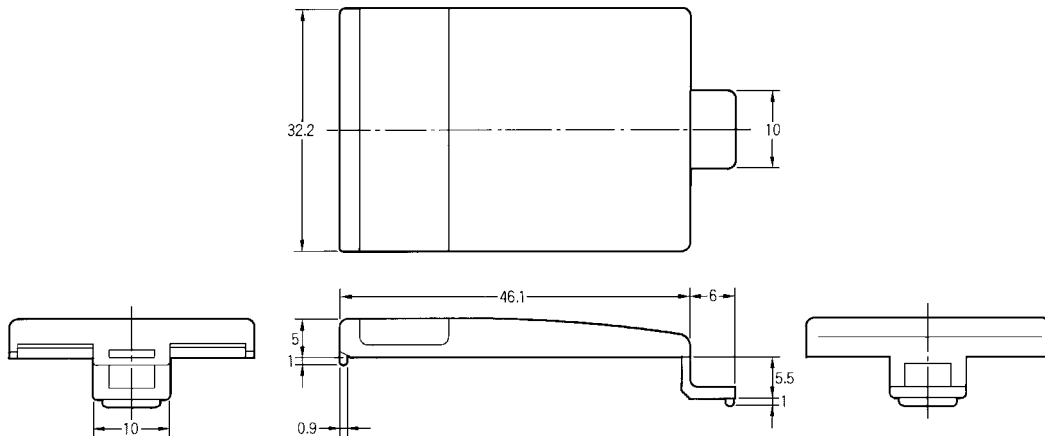

# Installation

## ■ Connection

Connection with S3D2 Sensor Controller

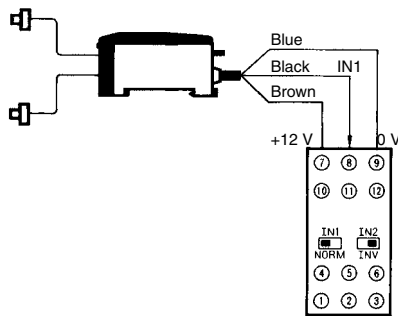

**Note:** A maximum of two E3X-N Sensors can be connected.

Connection with S3D8 Sensor Controller

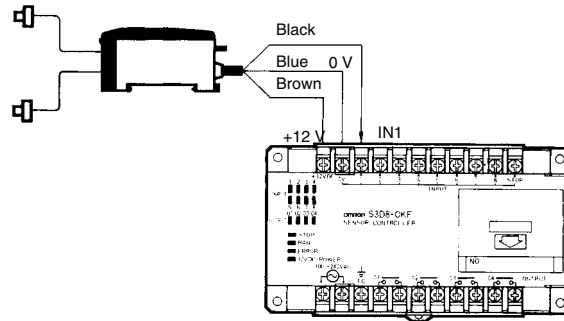

**Note:** 1. The E3X-N will switch to reverse operation by pressing the L Key.  
2. A maximum of eight E3X-NT Sensors can be connected. (For E3X-NM, a maximum of two unit can be connected.)

Power supply voltage	Output	Functions	Model
100 to 240 VAC	Relay	AND, OR	S3D2-AK
		AND, OR, and timer	S3D2-CK
		Flip-flop	S3D2-BK
	Transistor	AND, OR, and timer	S3D2-CC
	Relay	2 inputs, 2 outputs,	S3D2-DK
		2 inputs, 2 outputs, and timer	S3D2-EK
24 VDC	Relay	AND, OR	S3D2-AKD
		AND, OR, and timer	S3D2-CKD

# Precautions

## ■ Fiber Unit

### Tightening Force

The tightening force applied to the Fiber Unit should be as follows:

#### Screw-mounting Model

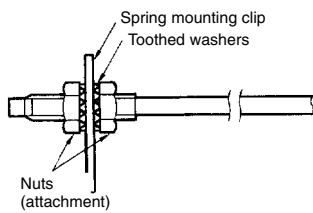

#### Cylindrical Model

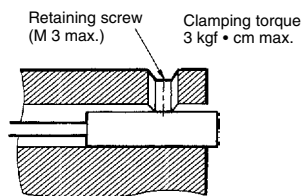

Fiber Units	Clamping torque
M3/M4 screw	0.78 N • m max.
M6 screw	0.98 N • m max.
2-mm dia. column	0.29 N • m max.
3-mm dia. column	0.29 N • m max.
E32-D14L	0.98 N • m max.
E32-T12F	0.78 N • m max.
E32-D12F	0.78 N • m max.
E32-T16	0.49 N • m max.
E32-R21	0.39 N • m max.
E32-M21	Up to 5 mm to the tip: 0.49 N • m max. Up to 5 mm from the tip: 0.78 N • m max.
E32-L25A	0.78 N • m max.
E32-T16P E32-T24S E32-L24L E32-L25L	0.29 N • m max.

Use a proper-sized wrench.

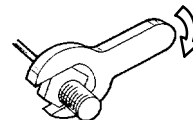

**Fiber Connection and Disconnection**

**E3X-NT/NM/NV/NVG**

The E3X-N Fiber Amplifier Unit adopts a snap-locking system. Connect or disconnect the Fiber Unit according to the following procedures:

**1. Connection**

- E3X-NT

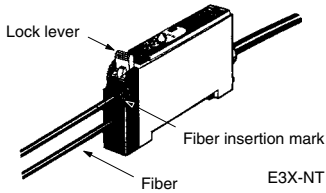

Remove the protection cover, insert the fiber into the Unit, and then lower the lock lever until a click sound is heard.

- E3X-NM

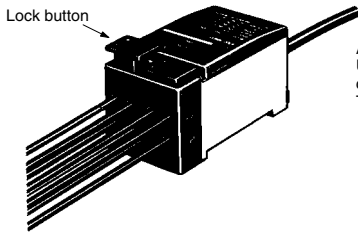

After inserting the fiber into the Unit, press the lock button until a click sound is heard. This will fix the fiber.

After cutting the fibers using the Fiber Cutter (E39-F4), place an insertion mark on the fiber so that it can be properly inserted into the Amplifier. Insert the fiber into the Amplifier up to this insertion mark.

**2. Disconnection**

- E3X-NT

Remove the protective cover, raise the lock lever, and then pull out the fiber.

- E3X-NM

Press the lock button again. The lock will be released and the button will pop up. Pull out the fiber. Do not forcibly pull up the lock button. (Be sure to pull out the fiber only after confirming that the lock has been released in order to maintain the fiber characteristics.)

**E3X-NT**

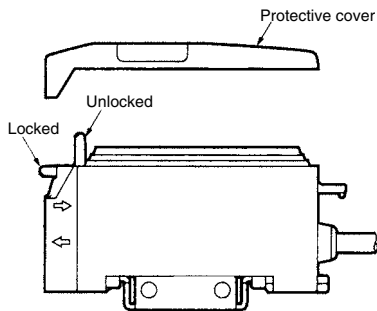

**E3X-NM**

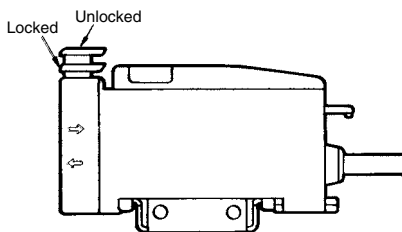

**E3X-NV/NVG**

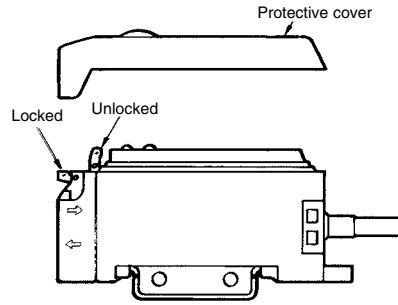

**3. Precaution When Connecting or Disconnecting Fibers**

Lock the fiber or release its lock under an ambient temperature range between -10°C and 40°C.

**Cutting Fiber**

Insert a fiber into the Fiber Cutter and determine the length of the fiber to be cut.

Press down the Fiber Cutter in a single stroke to cut the fiber.

An insertion mark can be placed on the fiber to serve as a reference when inserting the fiber into the Amplifier. Use the following procedure.

Confirm through the Cutter hole that the fiber is inserted beyond the insertion mark hole so that the insertion mark is properly indicated and then press firmly down on the Cutter.

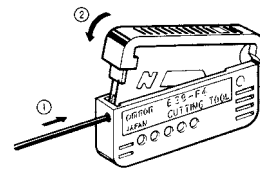

Insert the fiber into the Amplifier up to the insertion mark. Proper fiber performance will not be achieved unless the fiber is inserted all the way to the insertion mark. (This method is applicable to standard, 2.2-mm-diameter fibers only.)

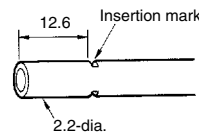

The cutting holes cannot be used twice. If the same hole is used twice, the cutting face of the fiber will be rough and the sensing distance will be reduced. Always use an unused hole.

Use either one of the two holes on the right (refer to the following figure) to cut a thin fiber as follows:

1. An attachment is temporarily fitted to a thin fiber before shipment.

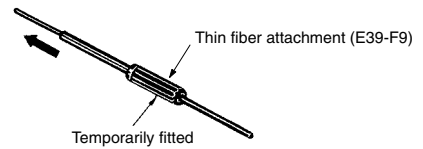

2. Secure the attachment after adjusting the position of it in the direction indicated by the arrow.



3. Insert the fiber into the E39-F4 to cut.

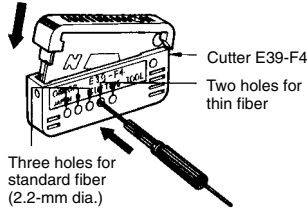

4. Finished state (proper cutting state).

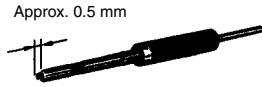

**Note:** Insert the fiber in the direction indicated by the arrow.

**Connection**

Do not pull or press the Fiber Units. The Fiber Units have a withstand force of 1 kgf or 3 kgf max. (Pay utmost attention because the fibers are thin).

Do not bend the Fiber Units beyond the permissible bending radius. Do not bend the edge of the Fiber Units.

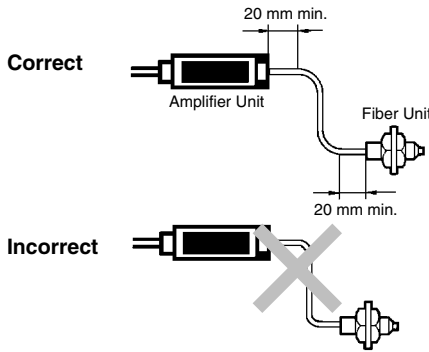

Do not apply excess force on the Fiber Units.

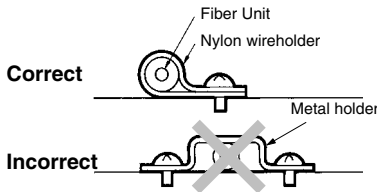

The Fiber Head could be broken by excessive vibration. To prevent this, the following is effective:

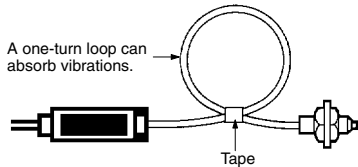

**Bending Radius**

**E39-F11 Sleeve Bender**

The bending radius of the stainless tube should be as large as possible. The smaller the bending radius becomes, the shorter the sensing distance will be.

Insert the tip of the stainless sleeve to the Sleeve Bender and bend the stainless sleeve slowly along the curve of the Sleeve Bender (refer to the figure).

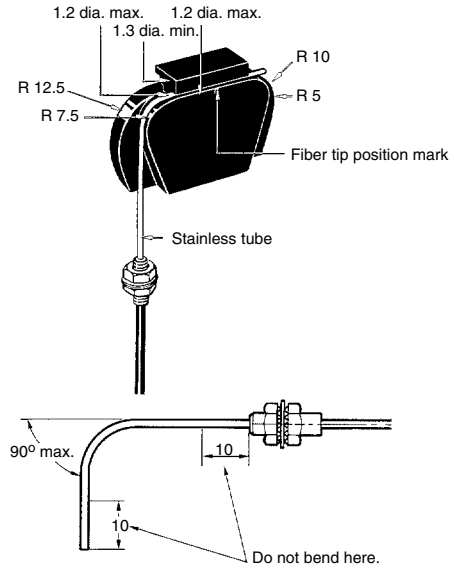

**Handling**

**E32-D51/-T51 Heat-resistant Fiber**

The bending radius of the fibers should be 35 mm min. Connecting fibers via the E39-F10 Fiber Connector is not possible. The withstand temperature of the Heat-resistant Fibers is 150°C max. In continuous operation, the ambient temperature should be 130°C max.

**E32-T14/-G14**

If the Sensor is ON because some object in front of the lenses reflects light, attach the black seals (sold together) to the lenses.

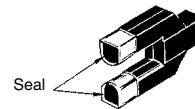

**E32-L25 (A) Wafer Sensor**

Insert the fiber with a white line into the light emission side of the Amplifier.

The tightening force of the sensor head is 8 kgf • cm max. (0.75 N • m).

Avoid places where water could be sprayed onto the E32-L25(A).

**E32-T16/-T16P Slit Seal (Attachment)**

Peel the E32-T16 Slit Seal off the ground paper and affix the Slit Seal to the sensing face of the Sensor so that the corners of the Slit Seal fit in with the corners of the sensing face. To detect an object at a distance of 45 cm max., a 0.5-mm wide Slit Seal must be used.

**E32-T16 Sensing Head**

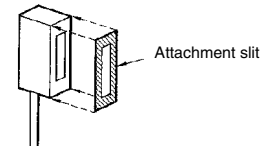

**E32-M21**

The four fibers must be separated so that there will be no mutual interference.



## ■ Amplifier Units

### Mounting

#### Mounting

1. Mount the front part on the mounting bracket (attachment) or a DIN track.
2. Press the back part onto the mounting bracket or the DIN track.

**Note:** Do not mount the back part onto the mounting bracket or the DIN track first and then mount the front part on the mounting bracket or the DIN track, or the mounting strength of the Amplifier Unit may decrease.

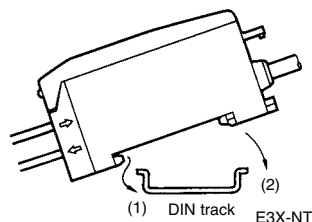

#### Dismounting

By pressing the Amplifier Unit in direction (3) and lifting the fiber insertion part in direction (4) as shown in the following, the Amplifier can be dismounted with ease.

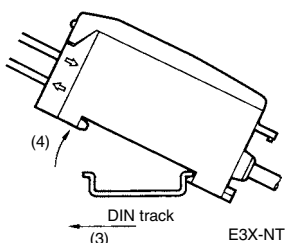

In the case of side mounting, attach the mounting bracket on the Amplifier first, and secure the Amplifier with M3 screws and washers. The diameter of the washers should be 6 mm max.

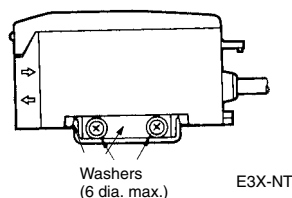

#### Turning Power On

After the E3X-N□ is turned on, the E3X-N□ will be ready to operate in 100 ms maximum. If power is supplied to the E3X-N□ and the load is connected to the E3X-N□ independently, be sure to turn on the power supply connected to the E3X-N□ first.

#### Output Short-circuit Protection

When the E3X-N□ is turned on or off, no control output will be ON, even though the operation indicator of the E3X-N□ will be lit for an instant. If the short-circuit protection function of the E3X-NM (four channels) is activated, none of the four channels will have any output.

#### Unused Channels of E3X-NM (Four Channels)

Unused channel protection seals are provided with the E3X-NM. If all the four channels are not used (e.g., if only three channels are used), paste an unused channel protection seal to the fiber insertion hole.

#### Mutual Interference Protection Function

In principle, use the E3X-NM (four channels) for the close connection of a maximum of four Fiber Units.

When closely connecting two to three Fiber Units to more than one E3X-NT (one channel), perform with/without-object teaching, in which case teaching must be performed on a single E3X-NT at a time. Therefore, turn on only the E3X-NT on which teaching is performed. If all the E3X-NTs are turned on, interrupt the emitters of the Fiber Units on which teaching is not performed.

#### EEPROM Writing Error

Power interruptions or noise caused by static electricity or other causes can result in write errors during any part of the teaching process from teaching initial operating levels without a workpiece to final compensations. These errors include buzzers, lighting of teaching indicators, simultaneous flashing of read/green indicators, lighting of operation indicators, and lighting or flashing of stability indicators. If any of these occur, re-input teaching using the teaching button on the Amplifier.

#### Others

When power is off:

The moment power is turned off, the E3X-N□ could output a pulse signal which could affect the operation of the devices connected to it. This will happen more often if power is supplied to the E3X-N□ from an external power supply, thus affecting the connected timer and counter. Use a built-in power supply as much as possible to avoid this.

In the case of the cord is extended, use a wire with 0.3 mm<sup>2</sup> min. The total length of the cord should be 100 m max.

Power supply:

If a standard switching regulator is used as a power supply, the frame ground (FG) terminal and the ground (G) terminal must be grounded, or otherwise the E3X-N□ can malfunction, influenced by the switching noise of the power supply.

The supplied voltage must be within the rated voltage range. Unregulated full- or half-wave rectifiers must not be used as power supplies.

Do not lay wiring to the Optical Sensor together with power lines in the same piping or ducts. Doing so will cause induction between the lines, possibly resulting in faulty operation or destruction. Always lay wiring to the Optical Sensor in separate or dedicated piping.

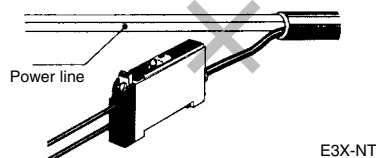

## ■ Attachment Units

### Applications

#### E39-F10 Fiber Connector

Use the following procedure (refer to the figure) to connect fibers via the Fiber Connector.

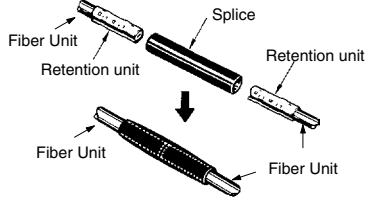

The Fiber Units should be as close as possible when they are connected.

Sensing distance will be reduced by approximately 25% when fibers are connected.

Only fibers with 2.2-mm dia. can be connected.

#### Protective Spiral Tube

Insert a fiber to the Protective Spiral Tube from the head connector side (screwed) of the tube.

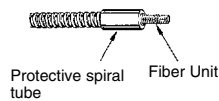

Push the fiber into the Protective Spiral Tube. The tube should be straight so that the fiber is not twisted when inserted. Then turn the end cap of the spiral tube.



Secure the Protective Spiral Tube on a suitable place with the attached nut.

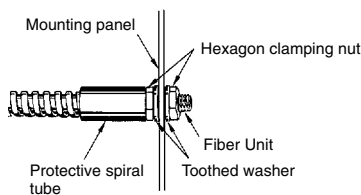

Use the attached saddle to secure the end cap of the Protective Spiral Tube. To secure the Protective Spiral Tube at a position other than the end cap, apply tape to the tube so that the portion becomes thicker in diameter.

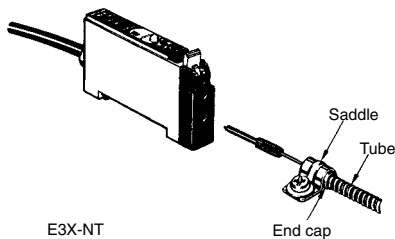

### WARNING

The E3X-N is not a safety component for ensuring the safety of people as defined in EC Directive 91/368/EEC, or as covered by separate European standards or by any other regulations or standards.



## **READ AND UNDERSTAND THIS DOCUMENT**

Please read and understand this document before using the products. Please consult your OMRON representative if you have any questions or comments.

## **WARRANTY**

OMRON's exclusive warranty is that the products are free from defects in materials and workmanship for a period of one year (or other period if specified) from date of sale by OMRON.

OMRON MAKES NO WARRANTY OR REPRESENTATION, EXPRESS OR IMPLIED, REGARDING NON-INFRINGEMENT, MERCHANTABILITY, OR FITNESS FOR PARTICULAR PURPOSE OF THE PRODUCTS. ANY BUYER OR USER ACKNOWLEDGES THAT THE BUYER OR USER ALONE HAS DETERMINED THAT THE PRODUCTS WILL SUITABLY MEET THE REQUIREMENTS OF THEIR INTENDED USE. OMRON DISCLAIMS ALL OTHER WARRANTIES, EXPRESS OR IMPLIED.

## **LIMITATIONS OF LIABILITY**

OMRON SHALL NOT BE RESPONSIBLE FOR SPECIAL, INDIRECT, OR CONSEQUENTIAL DAMAGES, LOSS OF PROFITS OR COMMERCIAL LOSS IN ANY WAY CONNECTED WITH THE PRODUCTS, WHETHER SUCH CLAIM IS BASED ON CONTRACT, WARRANTY, NEGLIGENCE, OR STRICT LIABILITY.

In no event shall responsibility of OMRON for any act exceed the individual price of the product on which liability is asserted.

IN NO EVENT SHALL OMRON BE RESPONSIBLE FOR WARRANTY, REPAIR, OR OTHER CLAIMS REGARDING THE PRODUCTS UNLESS OMRON'S ANALYSIS CONFIRMS THAT THE PRODUCTS WERE PROPERLY HANDLED, STORED, INSTALLED, AND MAINTAINED AND NOT SUBJECT TO CONTAMINATION, ABUSE, MISUSE, OR INAPPROPRIATE MODIFICATION OR REPAIR.

## **SUITABILITY FOR USE**

THE PRODUCTS CONTAINED IN THIS DOCUMENT ARE NOT SAFETY RATED. THEY ARE NOT DESIGNED OR RATED FOR ENSURING SAFETY OF PERSONS, AND SHOULD NOT BE RELIED UPON AS A SAFETY COMPONENT OR PROTECTIVE DEVICE FOR SUCH PURPOSES. Please refer to separate catalogs for OMRON's safety rated products.

OMRON shall not be responsible for conformity with any standards, codes, or regulations that apply to the combination of products in the customer's application or use of the product.

At the customer's request, OMRON will provide applicable third party certification documents identifying ratings and limitations of use that apply to the products. This information by itself is not sufficient for a complete determination of the suitability of the products in combination with the end product, machine, system, or other application or use.

The following are some examples of applications for which particular attention must be given. This is not intended to be an exhaustive list of all possible uses of the products, nor is it intended to imply that the uses listed may be suitable for the products:

Outdoor use, uses involving potential chemical contamination or electrical interference, or conditions or uses not described in this document.

Nuclear energy control systems, combustion systems, railroad systems, aviation systems, medical equipment, amusement machines, vehicles, safety equipment, and installations subject to separate industry or government regulations.

Systems, machines, and equipment that could present a risk to life or property.

Please know and observe all prohibitions of use applicable to the products.

NEVER USE THE PRODUCTS FOR AN APPLICATION INVOLVING SERIOUS RISK TO LIFE OR PROPERTY WITHOUT ENSURING THAT THE SYSTEM AS A WHOLE HAS BEEN DESIGNED TO ADDRESS THE RISKS, AND THAT THE OMRON PRODUCT IS PROPERLY RATED AND INSTALLED FOR THE INTENDED USE WITHIN THE OVERALL EQUIPMENT OR SYSTEM.

## **PERFORMANCE DATA**

Performance data given in this document is provided as a guide for the user in determining suitability and does not constitute a warranty. It may represent the result of OMRON's test conditions, and the users must correlate it to actual application requirements. Actual performance is subject to the OMRON Warranty and Limitations of Liability.

## **CHANGE IN SPECIFICATIONS**

Product specifications and accessories may be changed at any time based on improvements and other reasons.

It is our practice to change model numbers when published ratings or features are changed, or when significant construction changes are made. However, some specifications of the product may be changed without any notice. When in doubt, special model numbers may be assigned to fix or establish key specifications for your application on your request. Please consult with your OMRON representative at any time to confirm actual specifications of purchased products.

## **DIMENSIONS AND WEIGHTS**

Dimensions and weights are nominal and are not to be used for manufacturing purposes, even when tolerances are shown.

## **ERRORS AND OMISSIONS**

The information in this document has been carefully checked and is believed to be accurate; however, no responsibility is assumed for clerical, typographical, or proofreading errors, or omissions.

## **PROGRAMMABLE PRODUCTS**

OMRON shall not be responsible for the user's programming of a programmable product, or any consequence thereof.

## **COPYRIGHT AND COPY PERMISSION**

This document shall not be copied for sales or promotions without permission.

This document is protected by copyright and is intended solely for use in conjunction with the product. Please notify us before copying or reproducing this document in any manner, for any other purpose. If copying or transmitting this document to another, please copy or transmit it in its entirety.

**ALL DIMENSIONS SHOWN ARE IN MILLIMETERS.**

To convert millimeters into inches, multiply by 0.03937. To convert grams into ounces, multiply by 0.03527.

Cat. No. E233-E1-06 **In the interest of product improvement, specifications are subject to change without notice.**

**OMRON Corporation**  
Industrial Automation Company

Sensing Devices Division H.Q.  
Industrial Sensors Division  
Shiokoji Horikawa, Shimogyo-ku,  
Kyoto, 600-8530 Japan  
Tel: (81)75-344-7022/Fax: (81)75-344-7107