

FEATURES

- 0.4 inch (10.0 mm) DIGIT HEIGHT.
- CONTINUOUS UNIFORM SEGMENTS.
- LOW POWER REQUIREMENT.
- EXCELLENT CHARACTERS APPEARANCE.
- HIGH BRIGHTNESS & HIGH CONTRAST.
- WIDE VIEWING ANGLE.
- SOLID STATE RELIABILITY.
- CATEGORIZED FOR LUMINOUS INTENSITY.

DESCRIPTION

The LTS-4801B is a 0.4 inch (10.0 mm) digit height single digit seven-segment display. This device utilizes blue LED chips, which are made from GaN on a SiC substrate, and has a gray face and white segments.

DEVICE

PART NO.	DESCRIPTION
BLUE	Common Anode
LTS-4801B	Rt. Hand Decimal

PACKAGE DIMENSIONS

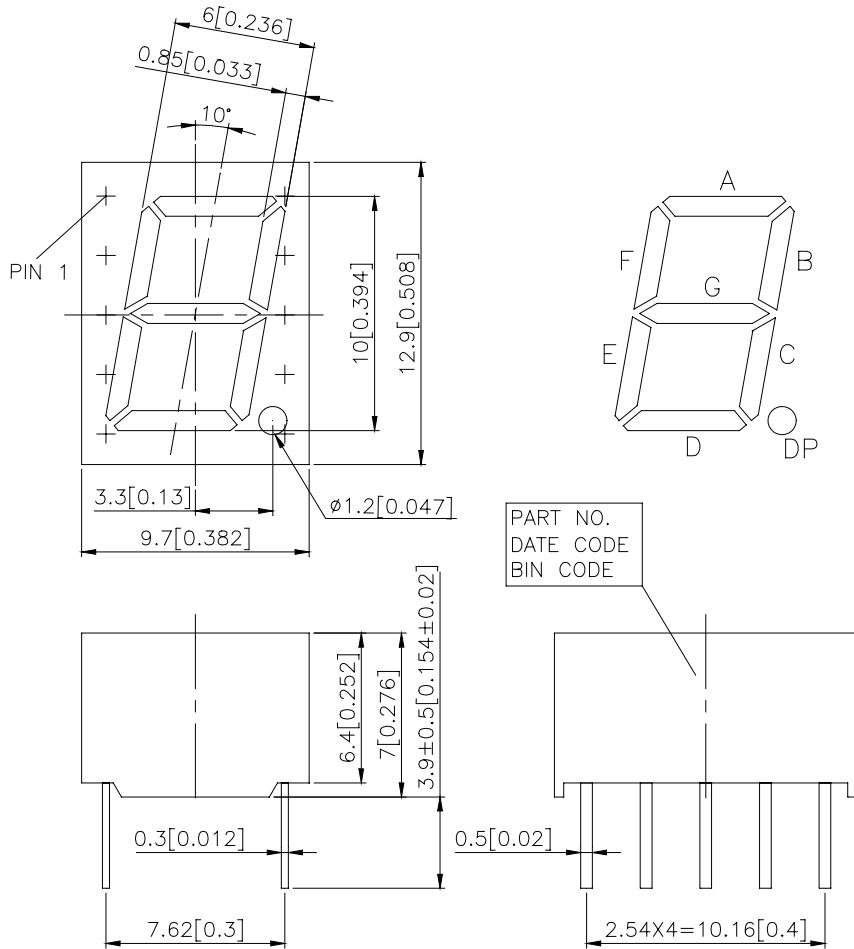

NOTES: All dimensions are in millimeters. Tolerances are ± 0.25 mm (0.01") unless otherwise noted.

INTERNAL CIRCUIT DIAGRAM

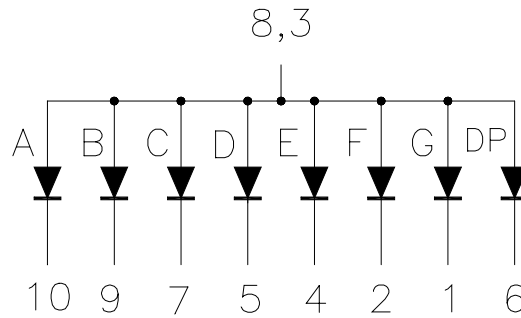

PIN CONNECTION

No.	CONNECTION
1	CATHODE G
2	CATHODE F
3	COMMON ANODE
4	CATHODE E
5	CATHODE D
6	CATHODE D.P.
7	CATHODE C
8	COMMON ANODE
9	CATHODE B
10	CATHODE A

ABSOLUTE MAXIMUM RATING AT Ta=25°C

PARAMETER	MAXIMUM RATING	UNIT
Power Dissipation Per Segment	115	mW
Peak Forward Current Per Segment (1/10 Duty Cycle, 0.1ms Pulse Width)	60	mA
Continuous Forward Current Per Segment	25	mA
Derating Linear From 25□ Per Segment	0.33	mA/□
Reverse Voltage Per Segment	5	V
Operating Temperature Range	-35□ to +85□	
Storage Temperature Range	-35□ to +85□	
Solder Temperature: max 260□ for max 3sec at 1.6mm[1/16inch] below seating plane.		

ELECTRICAL / OPTICAL CHARACTERISTICS AT Ta=25°C

PARAMETER	SYMBOL	MIN.	TYP.	MAX.	UNIT	TEST CONDITION
Average Luminous Intensity	I _v	1200	3600		μcd	I _F =10mA
Peak Emission Wavelength	λ _p		428		nm	I _F =20mA
Spectral Line Half-Width	Δλ		65		nm	I _F =20mA
Dominant Wavelength	λ _d		466		nm	I _F =20mA
Forward Voltage Per Segment	V _F		3.8	4.5	V	I _F =20mA
Reverse Current Per Segment	I _R			100	μA	V _R =5V
Luminous Intensity Matching Ratio	I _v -m			2:1		I _F =10mA

Note: Luminous intensity is measured with a light sensor and filter combination that approximates the CIE (Commision Internationale De L'Eclairage) eye-response curve.

TYPICAL ELECTRICAL / OPTICAL CHARACTERISTIC CURVES

(25°C Ambient Temperature Unless Otherwise Noted)

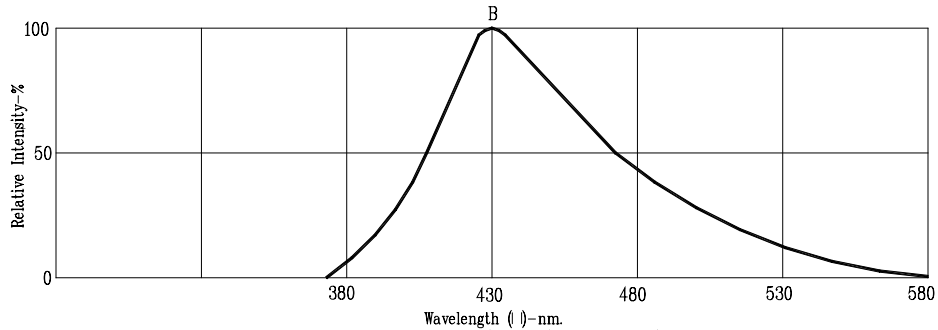

Fig1. RELATIVE INTENSITY VS. WAVELENGTH

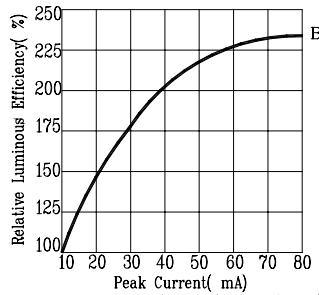

Fig2. RELATIVE LUMINOUS EFFICIENCY VS. PEAK FORWARD CURRENT (250us pulse width; 2ms period)

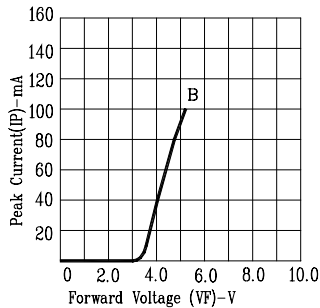

Fig3. FORWARD CURRENT VS. FORWARD VOLTAGE

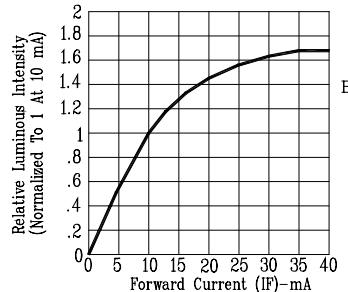

Fig4. RELATIVE LUMINOUS INTENSITY VS. FORWARD CURRENT

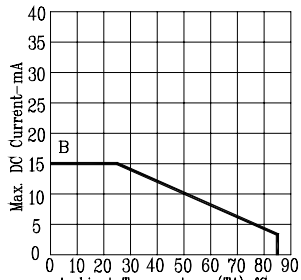

Fig5. MAX. ALLOWABLE DC CURRENT VS. AMBIENT TEMPERATURE.

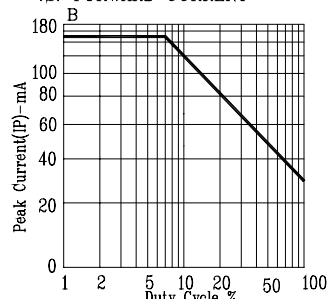

Fig6. MAX. PEAK CURRENT VS. DUTY CYCLE % (REFRESH RATE 1KHz)