

Murata Power Solutions' 50mV and 100mV base-mounted current shunts are designed for measuring dc currents from 5A to 1200A. These precision shunts (+/-0.25% accuracy) connect directly to MPS's DCA5-20PC Series of dc ammeters. Installation is straightforward: simply connect the load circuit to the shunt's threaded studs and the shunt's mV Kelvin-outputs to the digital ammeter's input terminals.

All models feature a rugged phenolic base that provides 750V isolation to the shunt's brass terminals, allowing for direct attachment to metal surfaces. A highly stable (+/-15ppm/°C) manganin sensing-element provides a wide -40 to +60°C operating temperature range. Please see the DCA5-20PC data sheet for additional ammeter-related information and detailed connection diagrams.



General Specifications (All Models)	
Rated Accuracy	±0.25% max.
Sensing Element	Manganin
Terminal Posts/Screws	Brass
Tightening Torque	See Mechanical Dimensions
Current Rating	See Selection Guide
Operating Temperature	-40 to + 60°C (-40 to +137°F)

Technical Notes

IMPORTANT! To ensure safe and reliable operation, dc shunts and all associated equipment must be installed and serviced by qualified technical personnel. Never make any connections to the shunt, the load, or the ammeter with energized power sources. Contact Murata Power Solutions if you have any questions regarding the installation or operation of any of our instruments and accessories.

1. Base-Mounted Shunt Precautions: DC current shunts are low value resistors that develop a mV output when current passes through their highly-stable manganin resistive element. Under high current, continuous use operation, dc shunts will dissipate considerable power and may undergo a significant temperature rise. For example, if allowed to operate continuously at its full rated load, a 500A/50mV shunt dissipates 25 Watts (500A x 0.050V = 25 Watts). Therefore, whenever possible, be sure to specify 50mV shunts due to their inherently lower power dissipation and voltage drop.

To ensure that the manganin sensing element does not exceed 125°C under worst case operating conditions, please read and follow the guidelines in the mounting and derating sections of this data sheet. Tighten all connections on the shunt per the torque specifications given in the mechanical dimensions and selection guide on page 3. Please note, the user is responsible for selecting the correct wire sizes (gauge) and wire type for the given application.

2. Mounting Considerations: All shunts should be mounted with their resistance blades in a vertical position to allow for natural convection cooling (see Figure 1). Forced-air cooling must be provided when vertical mounting is impractical, or in installations where the shunt is installed in a confined location. The shunt's manganin blades must never be allowed to exceed +125°C; doing so will cause permanent damage to the shunt.

Shunts must be installed in a manner that protects them from damage due to thermal expansion forces produced by high- or short-circuit currents. In most cases, shunts are weaker than their external-circuit connections, so provisions for additional wiring-flexibility may be required in high current and/or high-vibration applications.

Whenever practical, all shunts should be connected in the grounded side (normally the 'chassis') of the dc supply. However, these shunts must be connected in the grounded side of the circuit when the dc supply exceeds 750 volts (the rated limit for the shunt's phenolic insulating base). When more than one wire is to be connected to each end of a shunt, the wires must be evenly distributed between both terminals (see Figure 1).



Figure 1. Typical installation



3. Lead Extensions: The shunt's Kelvin outputs (i.e., their 50mV or 100mV output signal) should not exceed 24 inches in length (61cm), assuming 22AWG (0.5mm²) wire is used. If longer leads are necessary, the additional voltage drops in the leads must be taken into consideration as they will degrade accuracy and stability. However, MPS's DCA5 series dc ammeters feature a calibration potentiometer that can be used to compensate for some additional losses when long leads are employed; contact MPS for calibration information.

4. Continuous-Operation Derating: If continuous operation is required, a shunt must only be allowed to carry 2/3 of its maximum nameplate amperage. The 2/3 derating factor provides an adequate safety margin for convection cooled shunts operating in an ambient temperature of +25°C. The following two sections contain additional derating that is required when shunts will be exposed to higher operating temperatures or pulsed (intermittent) currents.

5. Temperature Derating: If the shunt is to be operated at ambient temperatures above +25°C, the maximum continuous current must be further derated from the 2/3 value previously noted.

To find the maximum permissible continuous current (I_e) at an elevated temperature (T_e), one must first calculate the maximum allowable power dissipation (P_e) at T_e, using the following formulas:

$$P_e = P_a \times [1 - (T_e - 25^\circ\text{C}) / 100^\circ\text{C}], \text{ and } I_e = \sqrt{\frac{P_e}{R}}$$

Where

I_e = Maximum permissible continuous current at elevated temperature T_e

P_e = Maximum power dissipation at the elevated temperature T_e

R = Shunt's resistance (see selection guide for values)

P_a = 0.667 x shunt's rated power at 25°C ambient

T_e = Elevated temperature

Example: How much current can a 150 Amp 50mV shunt safely carry at an ambient temperature of +100°C?

$$T_e = +100^\circ\text{C}$$

$$P_a = 0.667(150\text{A} \times 0.050\text{V}) = 5.0 \text{ Watts}$$

$$P_e = 5.0\text{W}[1 - (100 - 25) / 100] = 5.0\text{W} \times (1 - 0.75) = 1.25\text{W}$$

$$R = 0.00033 \text{ Ohms}$$

Lastly, use the formula $I_e = \sqrt{\frac{P_e}{R}}$ to find the maximum derated continuous-current at T_e = +100°C:

$$I_e = \sqrt{\frac{1.25\text{W}}{0.00033\Omega}} = 61.5\text{A}$$

6. Intermittent (Pulsed) Operation: Shunts that will not be exposed to continuous operation at 2/3 rated current can be operated at levels close to, or even above, their nameplate ratings for portions of short periods of times (5 minutes maximum) at 25°C ambient.

The following formulas can be used to calculate the maximum pulsed-current (I_{puls}) for a given shunt:

$$I_{puls} = \sqrt{P_{puls}/R}, \text{ and } P_{puls} = P_a/K_1, \text{ and } K_1 = \sqrt{D}$$

Where

I_{puls} = Maximum pulsed current

P_{puls} = Maximum pulsed power

P_a = 0.667 x shunt's rated power at 25°C ambient

D = Ratio of ON TIME to ON TIME + OFF TIME
(period not to exceed 5 minutes)

K₁ = Pulsed-operation rating factor (the square root of D)

R = Shunt's resistance (see selection guide for values)

Example: An 800 Amp 50mV shunt will be operated for 15 seconds each minute. What is the maximum current this shunt can carry during the 15-second ON time?

$$D = 15/60 = 0.25 \text{ and } K_1 = \sqrt{0.25} = 0.5$$

$$P_a = 0.667 (800\text{A} \times 0.050\text{V}) = 26.7 \text{ Watts}$$

$$P_{puls} = P_a/K_1 = 26.7\text{W}/0.5 = 53.4 \text{ Watts}$$

$$I_{puls} = \sqrt{\frac{53.4\text{W}}{0.0000625\Omega}} = 924\text{A}$$



Figure 2. Typical Low-Side Shunt Connections

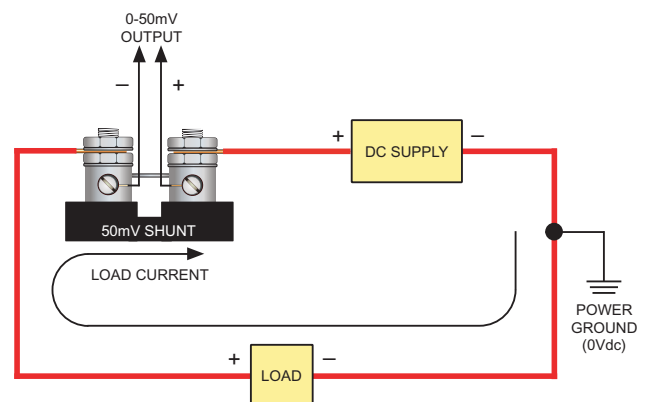

Figure 3. Typical High-Side Shunt Connections

MECHANICAL SPECIFICATIONS

5 through 150 Amps

Part No.	Rated Current/Output	Resistance (Ωs at 25°C)	Torque Range
3020-01097-0	5A/50mV	0.01	36-40 in-lbs (4.1-4.5Nm)
3020-01107-0	10A/100mV	0.01	36-40 in-lbs (4.1-4.5Nm)
3020-01098-0	20A/50mV	0.0025	36-40 in-lbs (4.1-4.5Nm)
3020-01096-0	50A/50mV	0.001	36-40 in-lbs (4.1-4.5Nm)
3020-01099-0	100A/50mV	0.0005	36-40 in-lbs (4.1-4.5Nm)
3020-01108-0	100A/100mV	0.001	36-40 in-lbs (4.1-4.5Nm)
3020-01100-0	150A/50mV	0.00033	36-40 in-lbs (4.1-4.5Nm)

8-32 Kelvin output screws (all shunts): 14-15 in-lbs (1.58-1.69Nm)

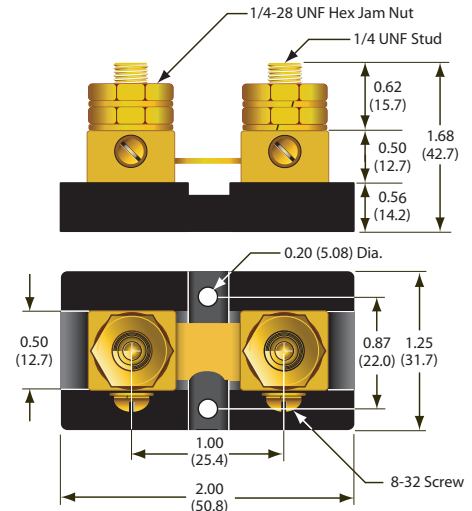

200 through 500 Amps

Part No.	Rated Current/Output	Resistance (Ωs at 25°C)	Torque Range
3020-01101-0	200A/50mV	0.00025	14-15 ft-lbs (19.0-20.3Nm)
3020-01102-0	300A/50mV	0.000167	14-15 ft-lbs (19.0-20.3Nm)
3020-01103-0	500A/50mV	0.0001	14-15 ft-lbs (19.0-20.3Nm)

8-32 Kelvin output screws (all shunts): 14-15 in-lbs (1.58-1.69Nm)

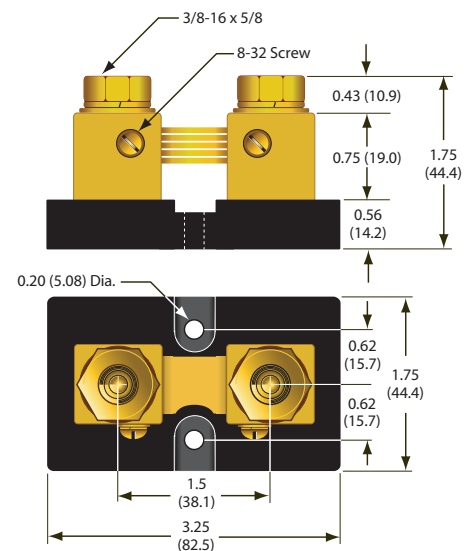

MECHANICAL SPECIFICATIONS *(continued)*

800 through 1200 Amps			
Part No.	Rated Current/Output	Resistance (Ωs at 25°C)	Torque Range
3020-01104-0	800A/50mV	0.0000625	32-35 ft-lbs (34.4-47.5Nm)
3020-01105-0	1000A/50mV	0.00005	32-35 ft-lbs (34.4-47.5Nm)
3020-01106-0	1200A/50mV	0.0000417	32-35 ft-lbs (34.4-47.5Nm)

8-32 Kelvin output screws (all shunts): 14-15 in-lbs (1.58-1.69Nm)

