

Standard Rectifier Module

1~ Rectifier	
V_{RRM}	= 1600 V
I_{DAV}	= 25 A
I_{FSM}	= 400 A

1~ Rectifier Bridge

Part number

VBO30-16N07

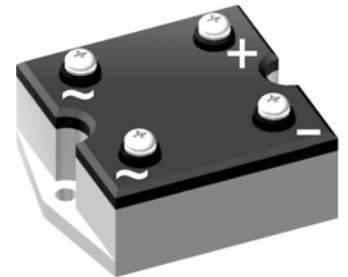

 E72873

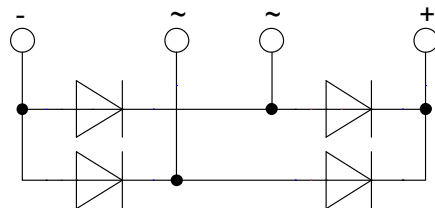

Features / Advantages:

- Package with DCB ceramic
- Improved temperature and power cycling
- Planar passivated chips
- Very low forward voltage drop
- Very low leakage current

Applications:

- Diode for main rectification
- For one phase bridge configurations
- Supplies for DC power equipment
- Input rectifiers for PWM inverter
- Battery DC power supplies
- Field supply for DC motors

Package: PWS-A

- Industry standard outline
- RoHS compliant
- Easy to mount with two screws
- Base plate: Aluminium internally DCB isolated
- Advanced power cycling

Rectifier				Ratings		
Symbol	Definition	Conditions	min.	typ.	max.	Unit
V_{RSM}	max. non-repetitive reverse blocking voltage	$T_{VJ} = 25^{\circ}C$			1700	V
V_{RRM}	max. repetitive reverse blocking voltage	$T_{VJ} = 25^{\circ}C$			1600	V
I_R	reverse current	$V_R = 1600\text{ V}$	$T_{VJ} = 25^{\circ}C$		40	μA
		$V_R = 1600\text{ V}$	$T_{VJ} = 150^{\circ}C$		1.5	mA
V_F	forward voltage drop	$I_F = 15\text{ A}$	$T_{VJ} = 25^{\circ}C$		1.10	V
					1.25	V
		$I_F = 30\text{ A}$	$T_{VJ} = 125^{\circ}C$		1.01	V
					1.21	V
I_{DAV}	bridge output current	$T_C = 85^{\circ}C$ rectangular $d = 0.5$	$T_{VJ} = 150^{\circ}C$		25	A
V_{FO}	threshold voltage		$T_{VJ} = 150^{\circ}C$		0.80	V
r_F	slope resistance				12.9	m Ω
R_{thJC}	thermal resistance junction to case				4.2	K/W
R_{thCH}	thermal resistance case to heatsink			0.6		K/W
P_{tot}	total power dissipation		$T_C = 25^{\circ}C$		29	W
I_{FSM}	max. forward surge current	$t = 10\text{ ms; (50 Hz), sine}$ $t = 8,3\text{ ms; (60 Hz), sine}$	$T_{VJ} = 45^{\circ}C$ $V_R = 0\text{ V}$		400	A
					430	A
		$t = 10\text{ ms; (50 Hz), sine}$ $t = 8,3\text{ ms; (60 Hz), sine}$	$T_{VJ} = 150^{\circ}C$ $V_R = 0\text{ V}$		340	A
					365	A
I^2t	value for fusing	$t = 10\text{ ms; (50 Hz), sine}$ $t = 8,3\text{ ms; (60 Hz), sine}$	$T_{VJ} = 45^{\circ}C$ $V_R = 0\text{ V}$		800	A ² s
					770	A ² s
		$t = 10\text{ ms; (50 Hz), sine}$ $t = 8,3\text{ ms; (60 Hz), sine}$	$T_{VJ} = 150^{\circ}C$ $V_R = 0\text{ V}$		580	A ² s
					555	A ² s
C_J	junction capacitance	$V_R = 400\text{ V; } f = 1\text{ MHz}$	$T_{VJ} = 25^{\circ}C$		10	pF

Package PWS-A			Ratings			
Symbol	Definition	Conditions	min.	typ.	max.	Unit
I_{RMS}	RMS current	per terminal			100	A
T_{stg}	storage temperature		-40		125	°C
T_{VJ}	virtual junction temperature		-40		150	°C
Weight				104		g
M_D	mounting torque		1.25		1.75	Nm
M_T	terminal torque		1.25		1.75	Nm
$d_{Spp/App}$	creepage distance on surface striking distance through air	terminal to terminal	6.5			mm
$d_{Spt/Apb}$		terminal to backside	8.5			mm
V_{ISOL}	isolation voltage	t = 1 second	3000			V
		t = 1 minute	2500			V

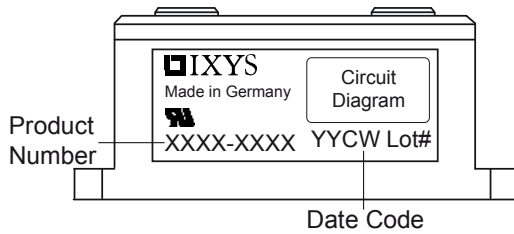

Ordering	Part Number	Marking on Product	Delivery Mode	Quantity	Code No.
Standard	VBO30-16NO7	VBO30-16NO7	Box	20	470627

Equivalent Circuits for Simulation

* on die level

$T_{VJ} = 150\text{ °C}$

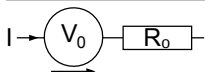

Rectifier

$V_{0\ max}$	threshold voltage	0.8	V
$R_{0\ max}$	slope resistance *	11.7	mΩ

Outlines PWS-A

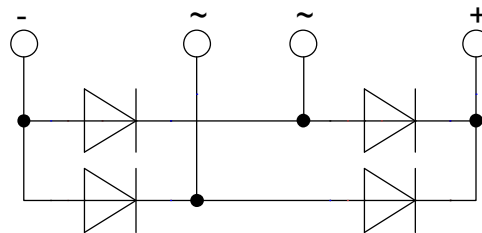
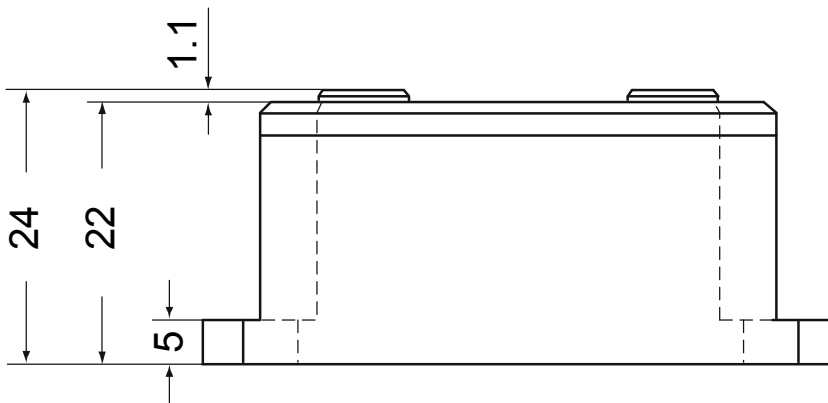
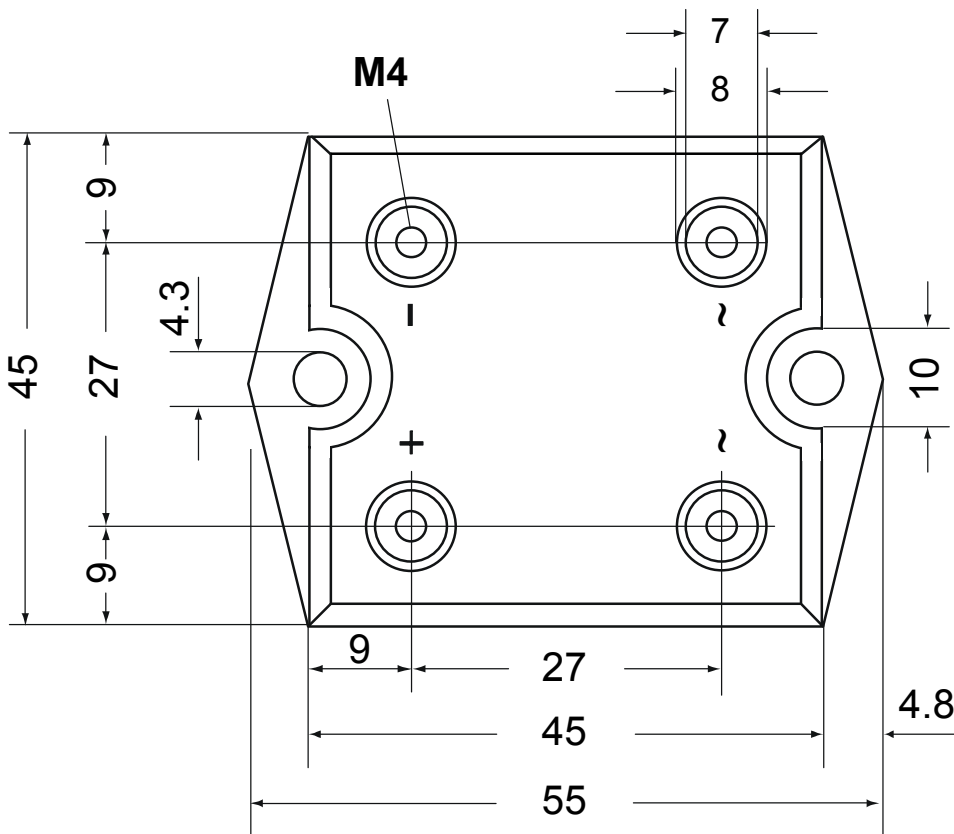

Rectifier

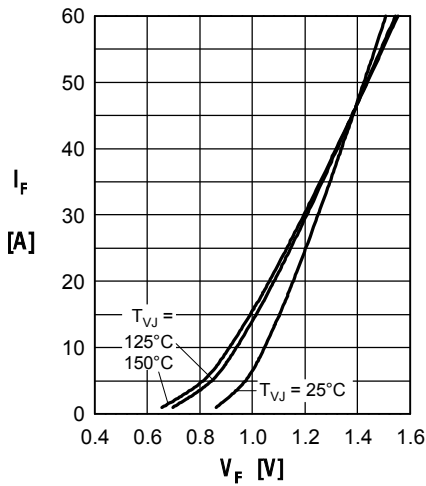

Fig. 1 Forward current vs. voltage drop per diode

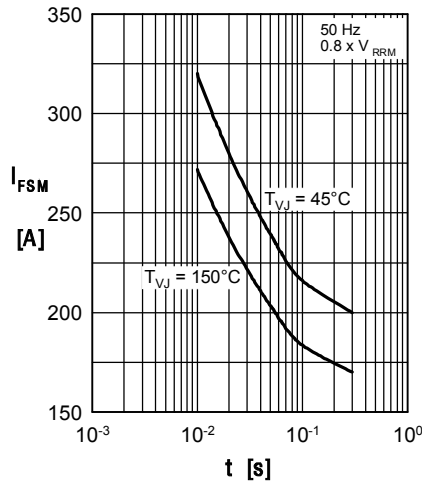

Fig. 2 Surge overload current vs. time per diode

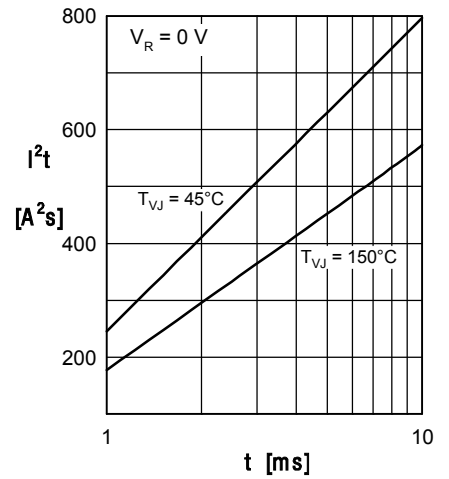

Fig. 3 I^2t vs. time per diode

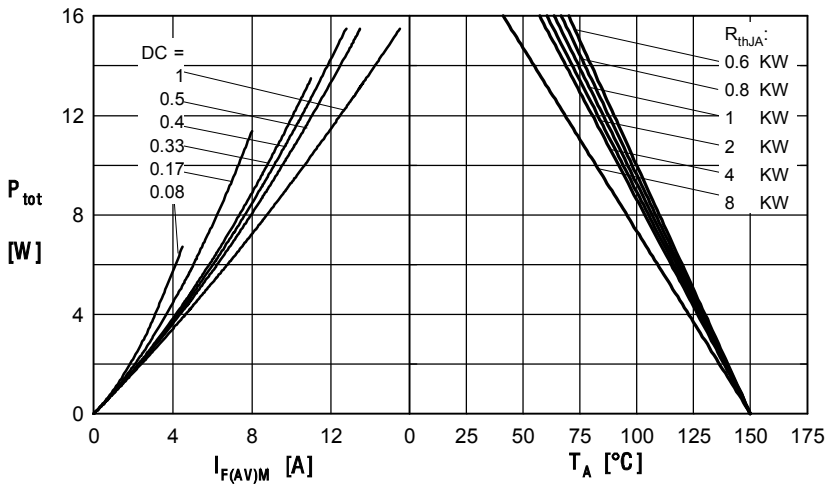

Fig. 4 Power dissipation vs. forward current and ambient temperature per diode

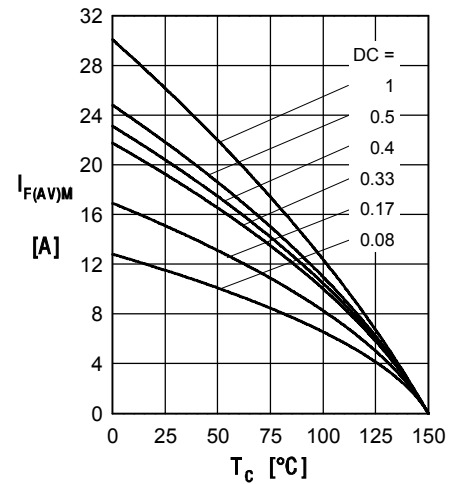

Fig. 5 Max. forward current vs. case temperature per diode

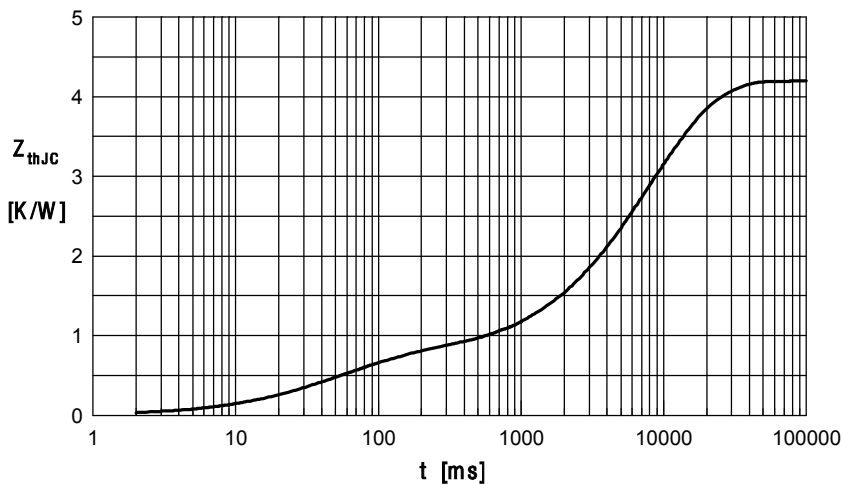

Fig. 6 Transient thermal impedance junction to case vs. time per diode

Constants for Z_{thJC} calculation:

i	R_{th} (K/W)	t_i (s)
1	0.194	0.024
2	0.556	0.070
3	0.450	3.250
4	3.000	9.300