

IB IL AI 4/EF ...

Inline Terminal With Four Differential Analog Input Channels

AUTOMATIONWORX

Data Sheet
7252_en_02

© PHOENIX CONTACT - 10/2006

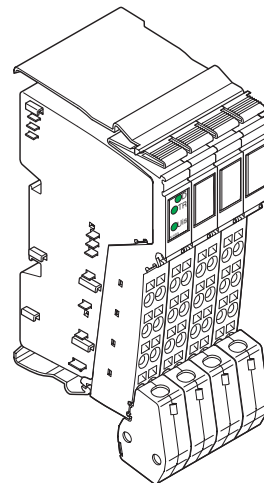

1 Description

The terminal is designed for use within an Inline station. It is used to acquire analog voltage or current signals.

Features

- Four differential analog signal inputs for the connection of either voltage or current signals
- Connection of sensors in 2, 3 or 4-wire technology
- Three current measuring ranges:
0 mA to 20 mA, ± 20 mA, 4 mA to 20 mA
- Four voltage measuring ranges:
0 V to 10 V, ± 10 V, 0 V to 5 V, ± 5 V
- Sensor supply with channel-specific integrated short-circuit and overload protection
- Measured values can be represented in four different formats
- Mean-value generation of measured values
- Process data update of all channels in 1 ms, maximum
- Bus-synchronous provision of input values
- High level of accuracy
- Parameterization and diagnostics via PCP
- Channels are configured independently of one another using the bus
- Resolution depends on the representation format and the measuring range
- Diagnostic indicators



This data sheet is only valid in association with the IB IL SYS PRO UM E user manual or the Inline system manual for your bus system.



The product versions differ in the scope of supply and the transmission speed (see "Ordering Data" on page 3). The function is identical. Differing technical data is indicated. For greater clarity, the order designation IB IL AI 4/EF is used throughout this document.



Make sure you always use the latest documentation.
It can be downloaded at www.download.phoenixcontact.com.
A conversion table is available on the Internet at www.download.phoenixcontact.com/general/7000_en_00.pdf.



This data sheet is valid for all products listed under "Ordering Data" on page 3.

Table of Contents

1	Description.....	1
2	Ordering Data.....	3
3	Technical Data.....	4
4	Local Diagnostic and Status Indicators and Terminal Point Assignment	8
4.1	Function Identification	8
4.2	Local Diagnostic and Status Indicators	8
4.3	Terminal Point Assignment for Each Connector	8
5	Installation Instructions	8
6	Internal Circuit Diagram.....	9
7	Electrical Isolation.....	10
8	Connection Notes	10
9	Connection Examples.....	10
10	Configuration and Analog Values	13
11	Programming Data/Configuration Data	13
11.1	INTERBUS.....	13
11.2	Other Bus Systems	13
12	Assignment of the Process Data to the Terminal Points for the "Read Analog Value" and "Configure Device and Read Analog Value" Commands.....	13
13	Process Data	14
14	OUT Process Data Words	15
14.1	Output Word OUT1 (Control Word).....	15
14.2	Output Words OUT2 to OUT5 (Configuration).....	16
14.3	Parameters for Configuration.....	16
15	IN Process Data Words	17
15.1	Input Word IN1 (Status Word).....	17
15.2	Input Words IN2 to IN5.....	17
16	Formats for the Representation of Measured Values (IN2 to IN5)	18
16.1	Format: "IB IL" (Default Setting).....	18
16.2	Format: "IB ST"	19
16.3	Format: "S7-Compatible"	20
16.4	Format: "Standardized Representation".....	21
16.5	Supported Error Codes for the "IB IL" and "Standardized Display" Formats	22
17	PCP Communication	22
17.1	Object Dictionary.....	22
17.2	Object Description.....	23
18	Diagnostics.....	25

2 Ordering Data

Terminals

Description	Type	Order No.	Pcs./Pck.
Terminal with four analog input channels; transmission speed of 500 kbps; including accessories (connectors and labeling fields)	IB IL AI 4/EF-PAC	2878447	1
Terminal with four analog input channels; transmission speed of 500 kbps; without accessories	IB IL AI 4/EF	2863478	1
Terminal with four analog input channels; transmission speed of 2 Mbps; including accessories (connectors and labeling fields)	IB IL AI 4/EF 2MBD-PAC	2878641	1
Terminal with four analog input channels; transmission speed of 2 Mbps; without accessories	IB IL AI 4/EF 2MBD	2878544	1



The listed connector is needed for the complete fitting of the IB IL AI 4/EF terminal.

Accessories

Description	Type	Order No.	Pcs./Pck.
Connector with shield connection (green, without color print)	IB IL SCN-6 SHIELD	2726353	5

Documentation

Description	Type	Order No.	Pcs./Pck.
User manual: "Configuring and Installing the INTERBUS Inline Product Range"	IB IL SYS PRO UM E	2743048	1
User manual: "Automation Terminals of the Inline Product Range"	IL SYS INST UM E	2698737	1

3 Technical Data

General Data

Housing dimensions (width x height x depth)	48.8 mm x 136.8 mm x 71.5 mm
Weight	125 g (without connectors)
Operating mode	Process data mode with 5 words/1 word PCP
Transmission speed	
IB IL AI 4/EF-PAC, IB IL AI 4/EF	500 kbps
IB IL AI 4/EF 2MBD-PAC, IB IL AI 4/EF 2MBD	2 Mbps
Connection method for sensors	2, 3, and 4-wire technology (shielded)
Permissible temperature (operation)	-25°C to +55°C
Permissible temperature (storage/transport)	-25°C to +85°C
Permissible humidity (operation/storage/transport)	10% to 95%, according to DIN EN 61131-2
Permissible air pressure (operation/storage/transport)	70 kPa to 106 kPa (up to 3000 m above sea level)
Degree of protection	IP20 according to IEC 60529
Protection class	Class 3 according to VDE 0106, IEC 60536
Connection data for connector	
Connection method	Spring-cage terminals
Conductor cross section	0.2 mm ² - 1.5 mm ² (solid or stranded), 24 - 16 AWG

Deviations From Common Technical Data That Are Indicated in the IB IL SYS PRO UM E User Manual

Noise Immunity Test According to EN 50082-2

Electrostatic discharge (ESD) according to EN 61000-4-2; IEC 61000-4-2	Criterion B 6 kV contact discharge 8 kV air discharge
--	---

Mechanical Requirements

Shock test according to EN 60068-2-27; IEC 60068-2-27	15g load for 11 ms, half sinusoidal wave, three shocks in each space direction and orientation 25g load for 6 ms, half sinusoidal wave, three shocks in each space direction and orientation
---	---

Interface

Local bus	Data routing
-----------	--------------

Power Consumption

	500 kbps	2 Mbps
Communications power U_L	7.5 V	7.5 V
Current consumption from U_L	85 mA (typical)/100 mA (maximum)	110 mA (typical)/125 mA (maximum)
I/O supply voltage U_{ANA}	24 V DC	24 V DC
Current consumption at U_{ANA}	13 mA (typical)/20 mA (maximum)	13 mA (typical)/20 mA (maximum)
Total power consumption	950 mW (typical)/ 1250 mW (maximum)	1140 mW (typical)/ 1420 mW (maximum)

Supply of the Module Electronics and I/O Through the Bus Coupler/Power Terminal

Connection method	Potential routing
-------------------	-------------------

Sensor Supply Voltage U_{IS} (via Supply of U_M)

Nominal value U_{IS}	24 V DC
Nominal current I_{IS} per channel	50 mA
Protection	Internal, channel-specific electronic fuse, short-circuit-proof with single-channel diagnostics

Analog Inputs

Number	4 differential analog inputs
Signals/resolution in the process data word (quantization)	See tables on page 18 and onwards
Measured value representation	In the following formats: IB IL (15 bits with sign bit) IB ST (12 bits with sign bit) S7-compatible (15 bits with sign bit) Standardized representation (15 bits with sign bit)



Please read the notes on page 18 and page 21 on measured value representation in "IB IL" and "standardized representation" format.

Digital filtering (mean-value generation)	None or over 4, 16 or 32 measured values Default setting: 16 measured values
Conversion time of the A/D converter	10 μ s, maximum
Process data update of the channels	< 1 ms
Limit frequency (-3 dB) of the input filters	500 Hz
Bus synchronism	Yes
Transient protection	Yes, via arresters

Differential Analog Voltage Inputs

Number	4
Input range	0 V to 10 V; ± 10 V; 0 V to 5 V; ± 5 V
Input resistance	300 k Ω , approximately
Open circuit response	Goes to 0 V
Maximum permissible voltage between analog voltage inputs and functional earth ground	± 50 V DC

Differential Analog Current Inputs

Number	4
Input range	0 mA to 20 mA; ± 20 mA; 4 mA to 20 mA
Input resistance	110 Ω , approximately (shunt)
Open circuit response	Goes to 0 mA
Maximum permissible current per current input	Overload protection
Maximum permissible voltage at the analog current inputs	± 30 V

Tolerance and Temperature Response

T_A = 25°C

Measuring Range	Absolute (Typical)	Absolute (Maximum)	Relative (Typical)	Relative (Maximum)
0 V to 5 V ±5 V	±2.5 mV	±7.5 mV	±0.05%	±0.15%
0 V to 10 V ±10 V	±2.5 mV	±10 mV	±0.025%	±0.10%
0 mA to 20 mA 4 mA to 20 mA ±20 mA	±14 µA	±40 µA	±0.07%	±0.20%

T_A = -25°C ... +55°C

Measuring Range	Absolute (Typical)	Absolute (Maximum)	Relative (Typical)	Relative (Maximum)
0 V to 5 V ±5 V	±9 mV	±20 mV	±0.18%	±0.40%
0 V to 10 V ±10 V	±13 mV	±30 mV	±0.13%	±0.30%
0 mA to 20 mA 4 mA to 20 mA ±20 mA	±22 µA	±80 µA	±0.11%	±0.40%



All percentage values refer to the relevant measuring range final value.
The values refer to nominal operation in the recommended mounting position (horizontal wall mounting).

Additional Tolerances Influenced by Electromagnetic Fields

Type of Electromagnetic Interference	Typical Deviation From the Measuring Range Final Value (Voltage Input)	Typical Deviation of the Measuring Range Final Value (Current Input)
	Relative	Relative
Electromagnetic fields; field strength 10 V/m according to EN 61000-4-3/IEC 61000-4-3	< ±1%	< ±1%
Conducted interference Class 3 (test voltage 10 V) according to EN 61000-4-6/IEC 61000-4-6	< ±1%	< ±1%
Fast transients (burst) 4 kV supply, 2 kV input according to EN 61000-4-4/IEC 61000-4-4	< ±1%	< ±1%

Safety Equipment

Inputs	Transient surge protection via arresters
Sensor supply voltage	Short-circuit protection with electronic fuse

Electrical Isolation/Isolation of the Voltage Areas



To provide electrical isolation between the logic level and the I/O area, it is necessary to supply the station bus coupler and the sensors connected to the analog input terminal described here from separate power supply units. Interconnection of the power supply units in the 24 V area is not permitted. (See also user manual.)

Common Potentials

The 24 V main voltage, 24 V segment voltage, and GND have the same potential. FE is a separate potential area.

Separate Potentials in the System Consisting of Bus Coupler/Power Terminal and I/O Terminal

- Test Distance

7.5 V supply (bus logic), 24 V supply U _{ANA} /analog I/O
7.5 V supply (bus logic), 24 V supply U _{ANA} /functional earth ground
Analog I/O/functional earth ground

- Test Voltage

500 V AC, 50 Hz, 1 min.
500 V AC, 50 Hz, 1 min.
500 V AC, 50 Hz, 1 min.

Error Messages to the Higher-Level Control or Computer System

Failure of the internal I/O voltage supply	Yes, I/O error message sent to the bus coupler
Failure of or insufficient communications power U_L	Yes, I/O error message sent to the bus coupler
Peripheral fault/user error	Yes, error message via the IN process data (see page 17)

Approvals

For the latest approvals, please visit www.download.phoenixcontact.com.

4 Local Diagnostic and Status Indicators and Terminal Point Assignment

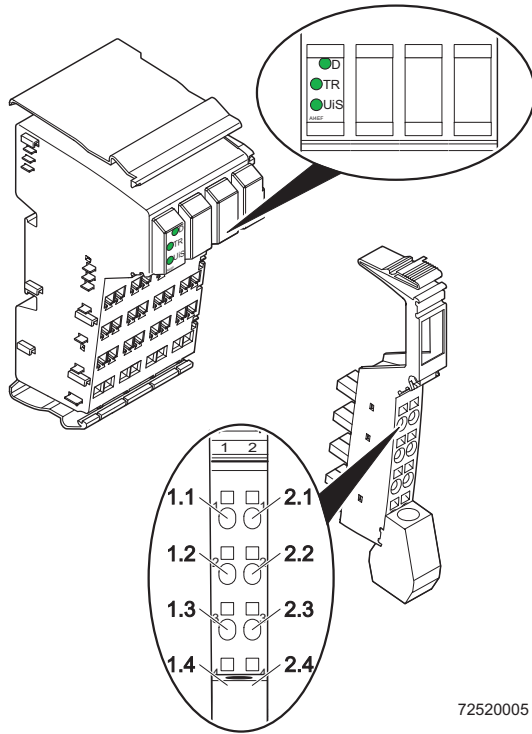

Figure 1 IB IL AI 4/EF terminal with an appropriate connector

72520005

4.1 Function Identification

Green

2 Mbps: White stripe in the vicinity of the D LED

4.2 Local Diagnostic and Status Indicators

Des.	Color	Meaning
D	Green	Diagnostics
TR	Green	PCP communication active
UiS	Green/red	Sensor supply
	Green ON	Sensor supply present
	Red ON	Overload/short circuit of sensor supply U_{iS} or supply voltage U_M not present



If the UiS LED is red, please also check the UM LED on the previous power terminal.

UiS red ON/UM ON: Overload/short circuit of the sensor supply U_{iS} ;
 UiS red ON/UM OFF: Supply voltage U_M not present

4.3 Terminal Point Assignment for Each Connector

Terminal Points	Signal	Assignment
1.1	U_{iSx} (24 V)	Initiator supply for channel x
2.1	GND	Ground for U_{iSx}
1.2	U_{x+}	Positive voltage input for channel x
2.2	U_{x-}	Minus input for channel x (voltage)
1.3	I_{x+}	Positive current input for channel x
2.3	I_{x-}	Minus input for channel x (current)
1.4, 2.4	Shield	Shield connection

x = 1 to 4

5 Installation Instructions

High current flowing through potential jumpers U_M and U_S leads to a temperature rise in the potential jumpers and inside the terminal. Observe the following instructions to keep the current flowing through the potential jumpers of the analog terminals as low as possible:



Create a separate main circuit for each analog terminal.

If this is not possible in your application and you are using analog terminals in a main circuit together with other terminals, place the analog terminals after all the other terminals at the end of the main circuit.



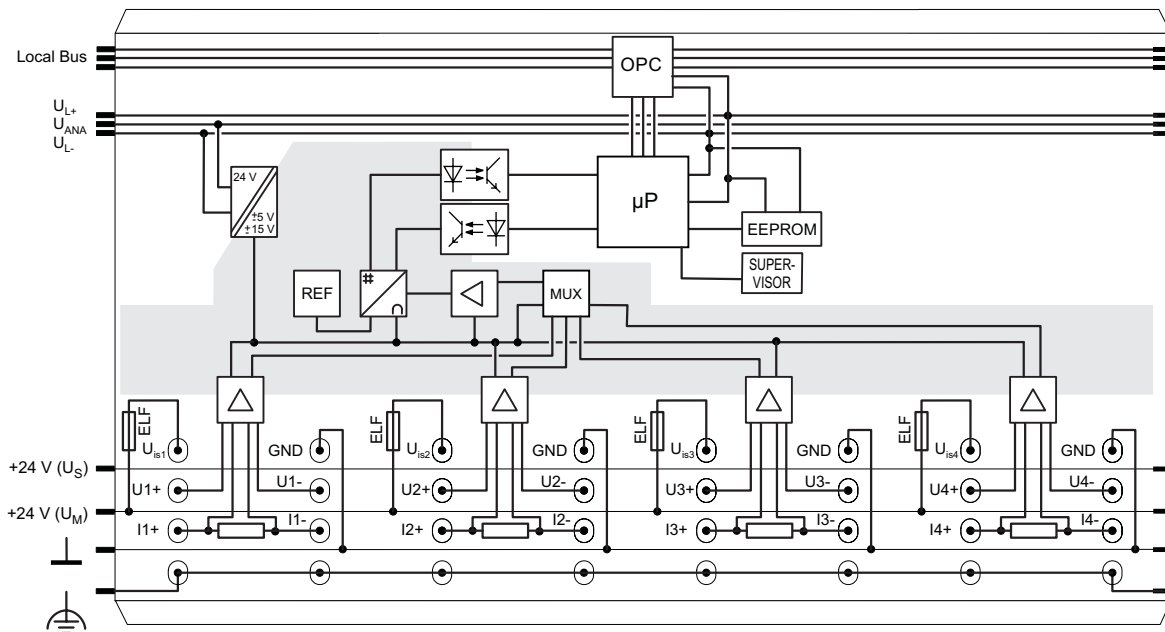









6 Internal Circuit Diagram



72520111

Figure 2 Internal wiring of the terminal points

Key:

	Protocol chip		Reference voltage
	Power supply unit with electrical isolation		Analog/digital converter
	Optocoupler		Amplifier
	Microprocessor		Multiplexer
	Electrically erasable programmable read-only memory		Electronic fuse
	Microprocessor monitoring		Resistor



Other symbols used are explained in the IB IL SYS PRO UM E user manual or in the Inline system manual for your bus system.

7 Electrical Isolation

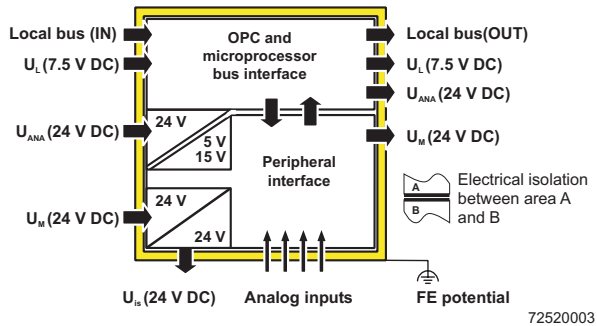

Figure 3 Electrical isolation of the individual function areas

8 Connection Notes



Always connect the analog sensors using shielded, twisted pair cables.

Connect the shielding to the terminal using the shield connection clamp. The clamp connects the shield to FE on the module side. Avoid connection to FE from both sides.

9 Connection Examples



Use a connector with shield connection when installing the sensors. Figure 4 shows the connection schematically (without shield connection).

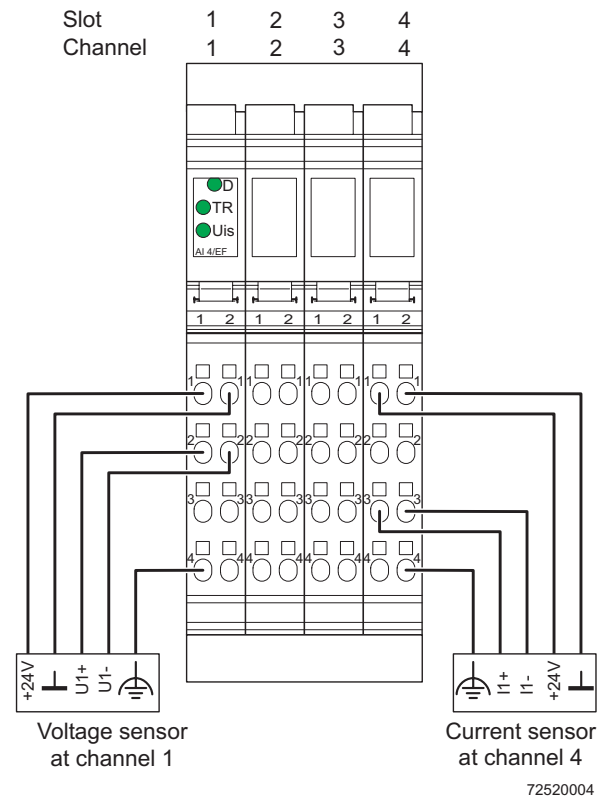

Figure 4 Connection of active sensors in 4-wire technology with shield connection

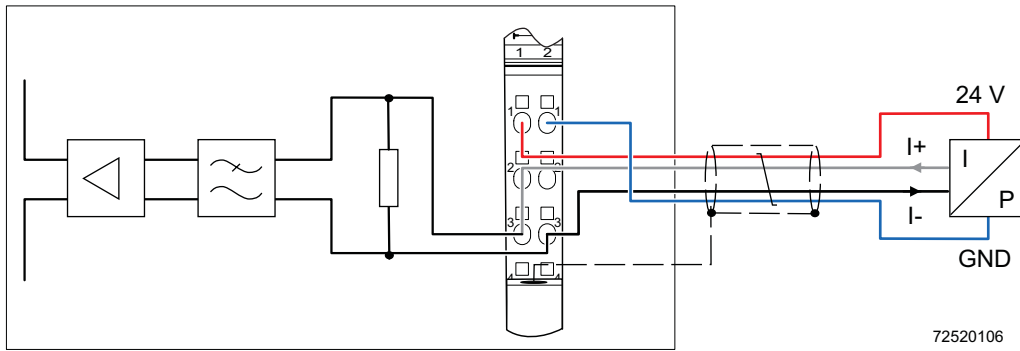

Figure 5 Passive pressure sensor at a differential current input

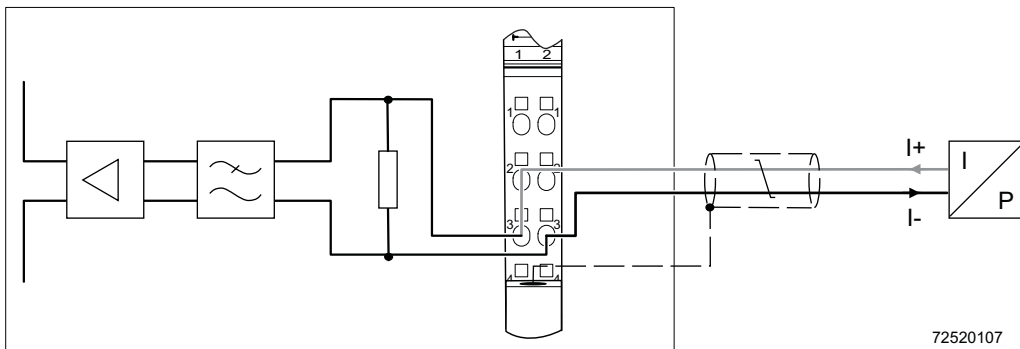

Figure 6 Active pressure sensor at a differential current input

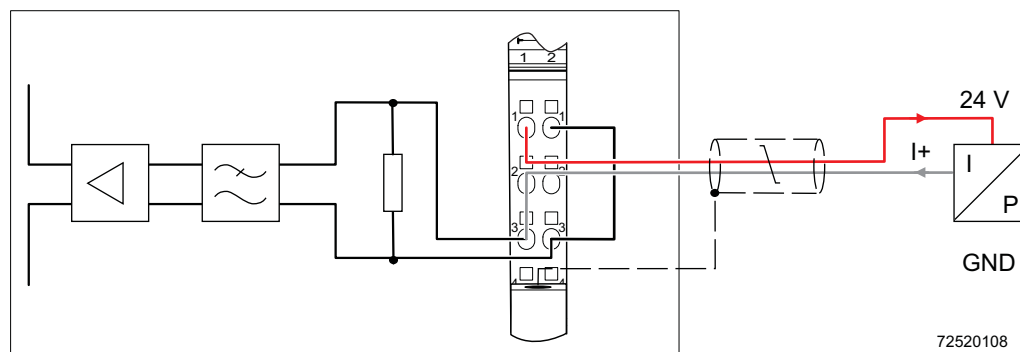

Figure 7 Passive 2-wire transmitter at a differential current input



Set the jumper on the connector or alternatively in the sensor for 4-wire technology.

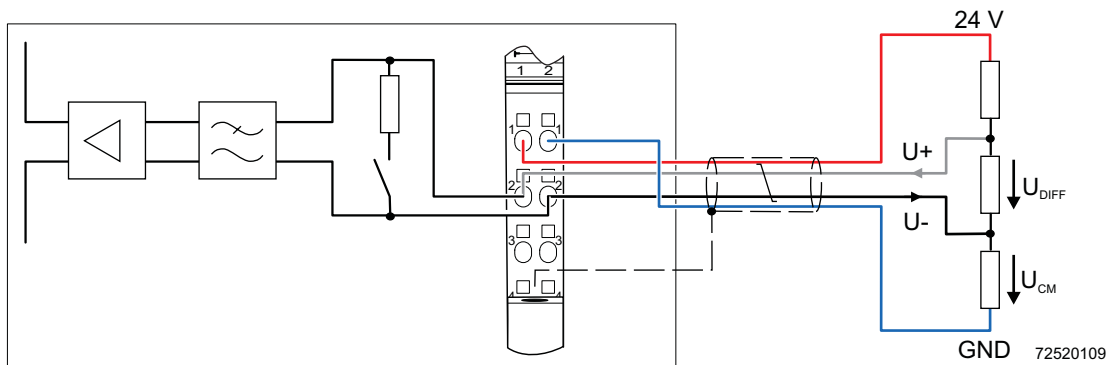

Figure 8 Passive voltage divider at a differential voltage input



Make sure that the voltage U_{CM} does not exceed the specified range, see "Differential Analog Voltage Inputs" on page 5.

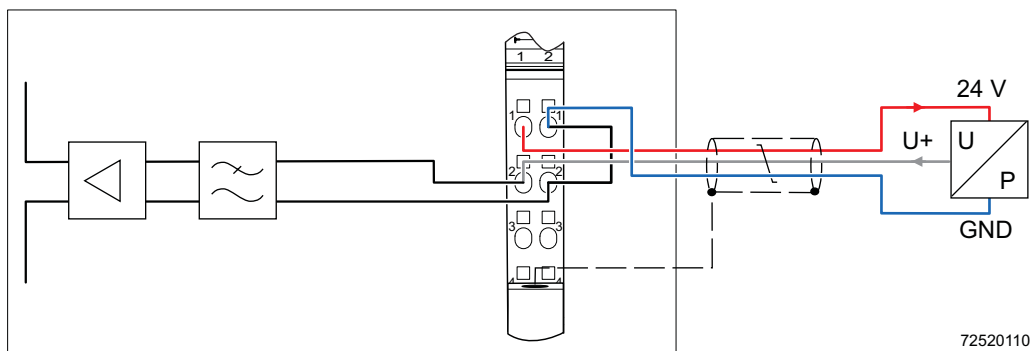

Figure 9 Active 3-wire transmitter differential voltage input



Set the jumper on the connector.

10 Configuration and Analog Values

You can **either** configure the device via process data **or** via PCP and transmit analog values accordingly.

If the device was configured via PCP, the configuration can no longer be modified the via process data.

11 Programming Data/Configuration Data

11.1 INTERBUS

ID code	DF _{hex} (223 _{dec})
Length code	05 _{hex}
Input address area	5 words
Output address area	5 words
Parameter channel (PCP)	1 word
Register length (bus)	6 words

11.2 Other Bus Systems



For the programming data/configuration data of other bus systems, please refer to the corresponding electronic device data sheet (e.g., GSD, EDS).

12 Assignment of the Process Data to the Terminal Points for the "Read Analog Value" and "Configure Device and Read Analog Value" Commands

(Word.bit) view	Word	Word x															
	Bit	15	14	13	12	11	10	9	8	7	6	5	4	3	2	1	0
(Byte.bit) view	Byte	Byte 0								Byte 1							
	Bit	7	6	5	4	3	2	1	0	7	6	5	4	3	2	1	0
AI Word 2: Channel 1 (connector 1) Word 3: Channel 2 (connector 2) Word 4: Channel 3 (connector 3) Word 5: Channel 4 (connector 4)	24 V	Terminal point 1.1: Sensor supply															
	GND	Terminal point 2.1: Ground															
	Signal	Terminal point 1.2: Positive voltage input Terminal point 1.3: Positive current input															
	Signal reference	Terminal point 2.2: Negative voltage input Terminal point 2.3: Negative current input															
	Shielding (FE)	Terminal point 1.4, 2.4															

13 Process Data

The device has 5 process data words and 1 PCP word. The first output word represents the control word because the assignment of the following words depends on the configuration. As confirmation for a control word action, the first input word contains a partial copy of the control word.

For the device configuration, channel-specific configuration data is set in the relevant channel output words. Once configuration has been completed, and depending on the format set, the measured values in the corresponding input words are either transmitted to the controller board or to the computer.

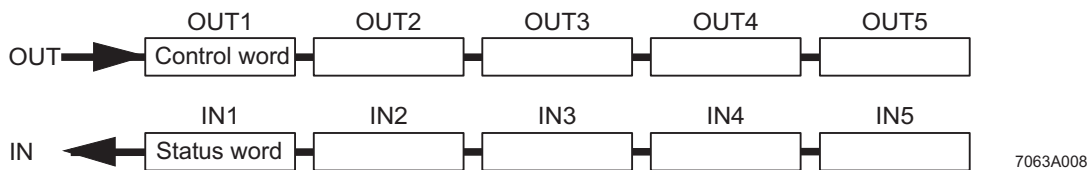

Figure 10 Order of the process data words

14 OUT Process Data Words

14.1 Output Word OUT1 (Control Word)

- For command code 400_{hex} and 500_{hex} ("Configure device" and "Read analog value")

		OUT1															
		Byte 0							Byte 1								
Bit		15	14	13	12	11	10	9	8	7	6	5	4	3	2	1	0
Assignment		Command code							0	0	0	0	0	0	0	0	PF

- For all other command codes

		OUT1															
		Byte 0							Byte 1								
Bit		15	14	13	12	11	10	9	8	7	6	5	4	3	2	1	0
Assignment		Command code							0	0	0	0	0	0	0	0	0

Bit 15 to bit 8 (command code)

Bit 15 to Bit 8	OUT1	Command Function
0 0 0 0 0 0 0 0	0000 _{hex}	Read analog value. The analog value of the four input channels is represented in IN2 to IN5.
0 0 0 1 0 0 C C	1x00 _{hex}	Read configuration. The configuration of each channel is displayed channel-by-channel in IN2. C: Channel number: 00 - channel 1; 01 - channel 2; 10 - channel 3; 11 - channel 4
0 0 1 1 1 1 0 0	3C00 _{hex}	Read device data. The firmware version and the device identification number is displayed in IN2, see "Input Words IN2 to IN5" on page 17.
0 1 0 0 0 0 0 0	400 _{hex}	Configure device. The channel parameters of the four channels are configured in OUT2 to OUT5.
0 1 0 1 0 0 0 0	500 _{hex}	Configure device and read analog value. The channel parameters of the four channels are configured in OUT2 to OUT5. The analog value of the four channels is represented in IN2 to IN5.

Bit 0

Bit 0	PF (Peripheral Fault in the Event of Sensor Errors)
0	Not permitted (default)
1	Permitted

This bit is only significant for command codes 40_{hex} and 50_{hex}.

14.2 Output Words OUT2 to OUT5 (Configuration)

Each channel can be configured independently of the other channels. The first channel is configured via the second output word, the second channel via the third output word, etc.

If the configuration changes, the corresponding channel is re-initialized. If the format "IB IL" is set, the error code "Measured value invalid" is output.

If the configuration is invalid, a corresponding error message is output in the status word. The configuration is stored in a volatile memory.

For commands 400_{hex} and 500_{hex}, specify the parameters for the appropriate channels 1 to 4 in OUT2 to OUT5. The parameter words are only evaluated by this command.

Bit	OUTx (x = 2 to 5)															
	15	14	13	12	11	10	9	8	7	6	5	4	3	2	1	0
Assignment	0	0	0	0	0	0	Filter	0	0	Format	Measuring range					

14.3 Parameters for Configuration

The values displayed in **bold** are default settings.

Bit 9 and bit 8

Code (bin)	Filter
00	Mean value via 16 measured values
01	No mean value
10	Mean value via 4 measured values
11	Mean value via 32 measured values

Bit 5 and bit 4

Code (bin)	Format
00	IB IL (15 bits)
01	IB ST (12 bits)
10	S7-compatible
11	Standardized representation

Bit 3 to bit 0

Code (bin)	Code (hex)	Measuring Range
0000	0	0 V to 10 V
0001	1	±10 V
0010	2	0 V to 5 V
0011	3	±5 V
1000	8	0 mA to 20 mA
1001	9	±20 mA
1010	A	4 mA to 20 mA
	4 to 7 B to F	Reserved

15 IN Process Data Words

15.1 Input Word IN1 (Status Word)

		OUT1															
		Byte 0							Byte 1								
Bit		15	14	13	12	11	10	9	8	7	6	5	4	3	2	1	0
Assignment	EB	Mirrored command code*							0	0	0	0	0	0	0	0	0

Error bit:

EB = 0 No error has occurred.

EB = 1 An error has occurred.

The error bit is available as a group error message. Possible errors and their effects are listed in "Diagnostics" on page 25.

*** Mirrored command codes:**

A command code mirrored from the control word. Here, the MSB is suppressed.

15.2 Input Words IN2 to IN5

The measured values, firmware version or configuration are transmitted to the controller board or the computer via IN process data words IN2 to IN5 according to the configuration.

For control words **0000_{hex}** and **5000_{hex}** (error-free standard operation) the measured values are transmitted in IN2 to IN5.

For control word **1x00_{hex}**, the configuration of the selected channel is indicated in IN2. For control word **3C00_{hex}**, IN2 supplies the firmware version and the device ID.

Example:

		IN2															
Bit		15	14	13	12	11	10	9	8	7	6	5	4	3	2	1	0
Assignment (hex)		1				2				3				6			
Meaning		Firmware Version 1.23												Device ID			

For control word **4000_{hex}** (configuration mode), the configuration data is mirrored in the input words after transfer.

16 Formats for the Representation of Measured Values (IN2 to IN5)

16.1 Format: "IB IL" (Default Setting)

The measured value is represented in bits 14 to 0. An additional bit (bit 15) is available as a sign bit.

This format supports extended diagnostics. Values $> 8000_{\text{hex}}$ and $< 8100_{\text{hex}}$ indicate an error. The error codes are listed on page 22.

Measured value representation in "IB IL" format (15 bits)

MSB														LSB	
15	14	13	12	11	10	9	8	7	6	5	4	3	2	1	0
SB	Analog value														

SB Sign bit

Significant Measured Values

Measuring range 0 mA to 20 mA/4 mA to 20 mA/0 V to 5 V/0 V to 10 V

Input Data Word (Two's Complement)		0 mA to 20 mA	4 mA to 20 mA	0 V to 5 V	0 V to 10 V
hex	dec	I_{Input} mA	I_{Input} mA	U_{Input} V	U_{Input} V
8001	Overrange	$> +21.6746$	$> +21.339733$	$> +5.419$	$> +10.837$
7F00	32512	$+21.6746$	$+21.339733$	$+5.419$	$+10.837$
7530	30000	$+20.0$	$+20.0$	$+5.0$	$+10.0$
0001	1	$+0.66667 \mu\text{A}$	$+4.00053333$	$+166.67 \mu\text{V}$	$+333.33 \mu\text{V}$
0000	0	≤ 0	$+3.2 \text{ to } +4.0$	≤ 0	≤ 0
8002	Open circuit	-	$< +3.2$	-	-

Measuring range -20 mA to +20 mA/-5 V to +5 V/-10 V to +10 V

Input Data Word (Two's Complement)		-20 mA to +20 mA	-5 V to +5 V	-10 V to +10 V
hex	dec	I_{Input} mA	U_{Input} V	U_{Input} V
8001	Overrange	$> +21.6746$	$> +5.419$	$> +10.837$
7F00	32512	$+21.6746$	$+5.419$	$+10.837$
7530	30000	$+20.0$	$+5.0$	$+10.0$
0001	1	$+0.66667 \mu\text{A}$	$+166.67 \mu\text{V}$	$+333.33 \mu\text{V}$
0000	0	0	0	0
FFFF	-1	$-0.66667 \mu\text{A}$	$-166.67 \mu\text{V}$	$-333.33 \mu\text{V}$
8AD0	-30000	-20.0	-5.0	-10.0
8100	-32512	-21.6746	-5.419	-10.837
8080	Underrange	< -21.6746	< -5.419	< -10.837

16.2 Format: "IB ST"

The measured value is represented in bits 14 to 3. An additional bit (bit 15) is available as a sign bit.

Measured value representation in "IB ST" format

MSB														LSB		
15	14	13	12	11	10	9	8	7	6	5	4	3	2	1	0	
SB	Analog value												0	OC	OR	

SB	Sign bit	0	Reserved
OC	Open circuit	OR	Overrange

Significant Measured Values

Measuring range 0 mA to 20 mA/4 mA to 20 mA/0 V to 5 V/0 V to 10 V

Input Data Word (Two's Complement)		0 mA to 20 mA	4 mA to 20 mA	0 V to 5 V	0 V to 10 V
hex	dec	I_{Input} mA	I_{Input} mA	U_{Input} V	U_{Input} V
7FF9	Overrange	> +21.5	> +21.5	> +5.375	> +10.75
7FF8	32760	+20.0 to +21.5	+20.0 to +21.5	+5.0 to +5.375	+10.0 to +10.75
7FF8	32760	+19.9951	+19.9961	+4.9988	+9.9975
4000	16384	+10	+12.0	+2.5	+5.0
0008	8	+0.0048828	+4.003906	+0.001221	+0.002441
0000	0	≤ 0	+3.2 to +4.0	≤ 0	≤ 0
0002	Open circuit	–	< +3.2	–	–

Measuring range -20 mA to +20 mA/-5 V to +5 V/-10 V to +10 V

Input Data Word (Two's Complement)		-20 mA to +20 mA	-5 V to +5 V	-10 V to +10 V
hex	dec	I_{Input} mA	U_{Input} V	U_{Input} V
7FF9	Overrange	> +21.5	> +5.375	> +10.75
7FF8	32760	+20.0 to +21.5	+5.00 to +5.375	+10.0 to +10.75
7FF8	32760	+19.9951	+4.9988	+9.9975
4000	16384	+10.0	+2.5	+5.0
0008	8	+0.0048828	+0.001221	0.002441
0000	0	0	0	0
FFF8	-8	-0.0048828	-0.001221	-0.002441
8000	-32768	-20.0 to -21.5	-5.0 to -5.375	-10.0 to -10.75
8001	-32767	< -21.5	< -5.375	< -10.75

16.3 Format: "S7-Compatible"

The measured value is represented in bits 14 to 0. An additional bit (bit 15) is available as a sign bit.

Measured value representation in "S7-compatible" format

MSB															LSB
15	14	13	12	11	10	9	8	7	6	5	4	3	2	1	0
SB	Analog value														

SB Sign bit

Significant Measured Values

Measuring range 0 mA to 20 mA/4 mA to 20 mA/0 V to 5 V/0 V to 10 V

Input Data Word (Two's Complement)		0 mA to 20 mA I_{Input} mA	4 mA to 20 mA I_{Input} mA	0 V to 5 V U_{Input} V	0 V to 10 V U_{Input} V
hex	dec				
7FFF	Overrange	> +23.5157	> +22.8142	> +5.879	> +11.759
7EFF	32511	+23.5157	+22.8142	+5.879	+11.759
6C00	27648	+20.0	+20.0	+5.0	+10.00
0001	1	+0.7234 μ A	+4.0005787	+180.85 μ V	+361.39 μ V
0000	0	\leq 0	+4.0	\leq 0	\leq 0
8000	Underrange	-	< +1.11852	-	-

Measuring range -20 mA to +20 mA/-5 V to +5 V/-10 V to +10 V

Input Data Word (Two's Complement)		-20 mA to +20 mA I_{Input} mA	-5 V to +5 V U_{Input} V	-10 V to +10 V U_{Input} V
hex	dec			
7FFF	Overrange	> +23.5157	> +5.879	> +11.759
7EFF	32511	+23.5157	+5.879	+11.759
6C00	27648	+20.00	+5.0	+10.0
0001	1	+0.7234 μ A	+180.85 μ A	+361.69
0000	0	0	0	0
FFFF	-1	-0.7234 μ A	-180.85 μ A	-361.69
9400	-27648	-20.0	-5.0	-10.0
8100	-32512	-23.516	-5.879	-11.759
8000	Underrange	< -23.516	< -5.879	< -11.759

Formula for Calculating the Measured Value From the Process Data Input Value for the 4 mA to 20 mA Measuring Range

$$\text{Measured value} = \text{Process data input value} \times 0.0005787 \text{ mA} + 4 \text{ mA}$$

	Example 1	Example 2
Process data input value	6C00 _{hex} = 27648 _{dec}	F940 _{hex} -> FFFF _{hex} - F940 _{hex} + 1 = -1728 _{dec}
Value x resolution	27648 x 0.0005787 mA = 16 mA	-1728 x 0.0005787 mA = -1 mA
+ 4 mA	16 mA + 4 mA = 20 mA	-1 mA + 4 mA = 3 mA
Measured value	20 mA	3 mA

16.4 Format: "Standardized Representation"

The data is represented in bits 14 to 0. An additional bit (bit 15) is available as a sign bit.

In this format, data is standardized to the measuring range and represented in such a way that it indicates the corresponding value without conversion. In this format one bit has the value of 1 mV or 1 μ A.

This format supports extended diagnostics. Values $> 8000_{\text{hex}}$ and $< 8100_{\text{hex}}$ indicate an error. The error codes are listed on page 22.

Measured value representation in "standardized representation" format

MSB															LSB
15	14	13	12	11	10	9	8	7	6	5	4	3	2	1	0
SB	Analog value														

SB Sign bit

Significant Measured Values

Measuring range 0 mA to 20 mA/4 mA to 20 mA/0 V to 5 V/0 V to 10 V

Input Data Word (Two's Complement)		0 mA to 20 mA I_{Input} mA	4 mA to 20 mA I_{Input} mA	0 V to 5 V U_{Input} V	0 V to 10 V U_{Input} V
hex	dec				
8001	Overrange	$> +21.6747$	$> +21.339$	$> +5.419$	$> +10.837$
4E20	20000	+20.0	–	–	–
2710	10000	+10.0	+14.0	–	+10.00
1388	5000	+5.0	+9.0	+5.0	+5.0
0001	1	+0.001	+4.001	+0.001	+0.001
0000	0	≤ 0	+4.0 to +3.2	≤ 0	≤ 0
8002	Open circuit	–	$< +3.2$	–	–

Measuring range -20 mA to +20 mA/-5 V to +5 V/-10 V to +10 V

Input Data Word (Two's Complement)		-20 mA to +20 mA I_{Input} mA	-5 V to +5 V U_{Input} V	-10 V to +10 V U_{Input} V
hex	dec			
8001	Overrange	$> +21.6747$	$> +5.419$	$> +10.837$
4E20	20000	+20.0	–	–
2710	10000	+10.0	–	+10.0
1388	5000	+5.0	+5.0	+5.0
0001	1	0.001	+0.001	+0.001
0000	0	0	0	0
FFFF	-1	-0.001	-0.001	-0.001
EC78	-5000	-5.0	-5.0	-5.0
D8F0	-10000	-10.0	–	-10.0
B1E0	-20000	-20.0	–	–
8080	Underrange	< -21.6747	< -5.419	< -10.837

16.5 Supported Error Codes for the "IB IL" and "Standardized Display" Formats

After an error message, the following errors/messages for "IB IL" and "standardized representation" format are displayed in words IN2 to IN5 in the status word (error bit):

Supported Error Codes in "IB IL" Format

Input Data Word (hex)	Error
8001	Overrange
8002	Open circuit
8004	Measured value invalid
8020	Sensor and/or analog supply not present
8040	Device faulty
8080	Underrange

17 PCP Communication



For information on PCP communication, please refer to the IBS SYS PCP G4 UM E (Order No. 2745169) and IBS PCP COMPACT UM E (Order No. 9015349) user manuals.

By default upon delivery, the device is configured according to the default settings listed on page 16. The device can be configured to suit your application using process data or PCP.

In PCP mode, the device is configured with the "Config Table" object.



The IBS CMD (for standard controller boards) and PC WorX (for Field Controllers (FC) and Remote Field Controllers (RFC)) programs are available for the configuration and parameterization of your INTERBUS system.

For additional information, please refer to the "IBS CMD SWT G4 UM E" (Order No. 2722250) user manual and the documentation for your applied PC WorX version.

17.1 Object Dictionary

Index	Data Type	N	L	Meaning	Object Name	Rights
0080 _{hex}	Array of Unsigned 16	5	2		Config Table	rd/wr
0081 _{hex}	Array of Unsigned 16	4	2		Analog Values	rd

N: Number of elements

rd: Read access permitted

L: Length of an element in bytes

wr: Write access permitted

17.2 Object Description

Config Table Object

Configure the device using this object.

Object description:

Object	Config Table	
Access	Read, write	
Data type	Array of Unsigned 16	5 x 2 bytes
Index	0080 _{hex}	
Subindex	00 _{hex}	Write all elements
	01 _{hex}	Configuration channel 1
	02 _{hex}	Configuration channel 2
	03 _{hex}	Configuration channel 3
	04 _{hex}	Configuration channel 4
	05 _{hex}	System bits
Length (bytes)	0A _{hex}	Subindex 00 _{hex}
	02 _{hex}	Subindex 01 _{hex} to 05 _{hex}
Data	Device configuration	

Element Value Range

The "Configuration channel x" elements have the following structure:

Bit	15	14	13	12	11	10	9	8	7	6	5	4	3	2	1	0
Assignment	0	0	0	0	0	0	Filter	0	0	Format	Output range					

For the value ranges for the individual parameters, please refer to "Parameters for Configuration" on page 16.

The "System bits" element has the following structure:

Bit	15	14	13	12	11	10	9	8	7	6	5	4	3	2	1	0
Assignment	0	0	0	0	0	0	0	0	0	0	0	0	0	PF	0	Conf

"PF"

If bit 2 = 1, a peripheral fault is generated in the event of a sensor problem (overrange, underrange, open circuit).

"Conf"

If bit 0 = 1, configuration via process data is permitted (command code 400_{hex} or 500_{hex}).

If an invalid configuration is specified, a negative confirmation is generated with error message 08_{hex}, 00_{hex} or xx30_{hex}. The low byte of the additional error code is 30_{hex} (value is out of range), the high byte contains the number of the affected element.

Example: Config Table is completely written with data (subindex 00) and the entry for channel 2 is invalid. In this case, the additional error code is equal to 0230_{hex}.

Analog Values Object

The elements of this object contain the analog values of the channels in the format that was selected for this channel.

Object description:

Object	Analog Values	
Access	Read	
Data type	Array of Unsigned 16	4 x 2 bytes
Index	0081 _{hex}	
Subindex	00 _{hex}	Read all elements
	01 _{hex}	Analog value channel 1
	02 _{hex}	Analog value channel 2
	03 _{hex}	Analog value channel 3
	04 _{hex}	Analog value channel 4
Length (bytes)	08 _{hex}	Subindex 00 _{hex}
	02 _{hex}	Subindex 01 _{hex} to 04 _{hex}
Data	Analog values of the channels	

DiagState Object

The elements of this object contain the current diagnostic status of the device.

Object description:

Object	DiagState	
Access	Read	
Data type	Record	
Index	0018 _{hex}	
Subindex	00 _{hex}	Read all elements
	01 _{hex}	Consecutive no. Unsigned 16 (2 bytes)
	02 _{hex}	Priority Unsigned 8 (1 byte)
	03 _{hex}	Channel Unsigned 8 (1 byte)
	04 _{hex}	Code Unsigned 16 (2 bytes)
	05 _{hex}	MoreFollows Unsigned 8 (1 byte)
	06 _{hex}	Text OctetString (10 bytes)
Length (bytes)	11 _{hex}	Subindex 00 _{hex}
	01 _{hex}	Subindex 02 _{hex} , 03 _{hex} , 05 _{hex}
	02 _{hex}	Subindex 01 _{hex} , 04 _{hex}
	0A _{hex}	Subindex 06 _{hex}
Data	Diagnostic status of the device	

	Meaning	Possible Values
Consecutive no.	Unique, consecutive error number since the last power up reset or history reset	0 to 65535
Priority	Priority of the message	If Code = 0000 _{hex} , Priority = 00 _{hex} otherwise Priority = 02 _{hex}
Channel		If Code = 0000 _{hex} , Channel = 00 _{hex} otherwise Channel = 01 _{hex} to 04 _{hex}
Code	Error code	0000 _{hex} : No error 8910 _{hex} : Overrange 8920 _{hex} : Underrange 7710 _{hex} : Cable break 5160 _{hex} : Power supply error 5010 _{hex} : Hardware fault
MoreFollows	00 _{hex} = No additional information is available for this error.	00 _{hex}
Text	The first 10 characters of the status message. Default: "Status OK"	If Code = 0000 _{hex} , Text = "Status OK" otherwise text contains error-specific information

18 Diagnostics

The following events are monitored and indicated:

Event	Response
Open circuit, overrange and underrange of the measuring range	<ul style="list-style-type: none"> – Error bit set – Indication of an error code in the measured value (only for "IB IL" and "standardized representation" format) – Generation of a peripheral fault, if this was permitted during configuration
Voltage failure of the sensor supply	<ul style="list-style-type: none"> – Error bit set – Device error – Indication of an error code in the measured value (only for "IB IL" and "standardized representation" format) – Generation of a peripheral fault, if this was permitted during configuration
Voltage failure of the internal analog device supply (5 V and 15 V)	<ul style="list-style-type: none"> – Error bit set – Indication of an error code in the measured value (only for "IB IL" and "standardized representation" format) – Generation of a peripheral fault, if this was permitted during configuration
Faulty configuration	<ul style="list-style-type: none"> – Error bit set

© PHOENIX CONTACT 10/2006