

May 2015

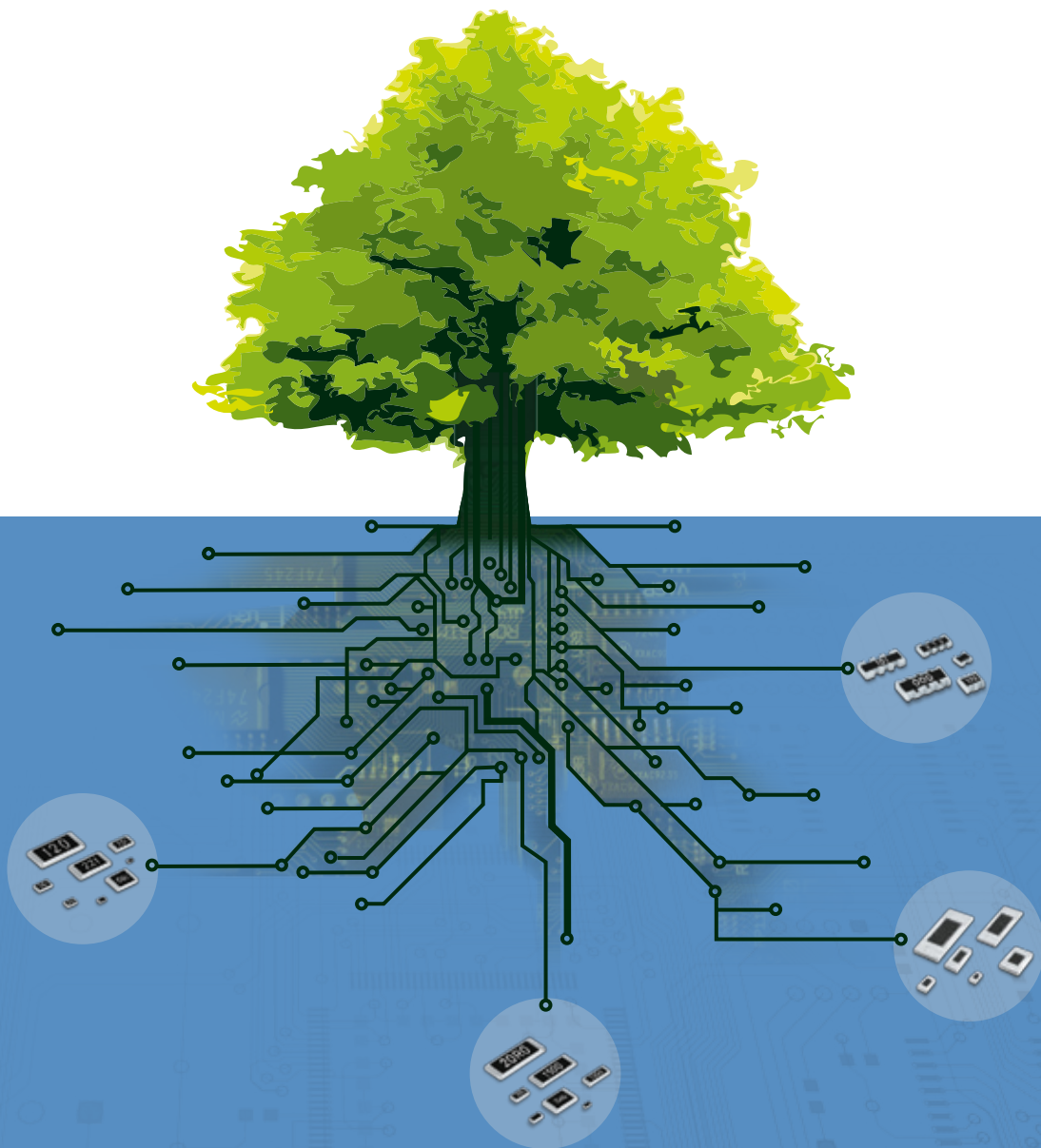

THICK-FILM CHIP RESISTOR



SAMSUNG
ELECTRO-MECHANICS





We, Samsung, declare that our component Chip Resistor is produced in accordance with EU RoHS directive.

1. RoHS Compliance and restriction of Br

The following restricted materials are not used in packaging materials as well as products in compliance with the law and restriction.

- Cd, Pb, Hg, Cr6+, As, Br and the compounds, PCB, asbestos
- Bromic materials : PBBs, PBBOs, PBDO, PBDE, PBB

2. No use of materials breaking Ozone layer

The following ODS materials are not used in our fabrication process.

- ODS material : Freon, Haron, 1-1-1 TCE, CCl4, HCFC

If you want more detailed Information, Please Visit Samsung Electro-mechanics Website
[<http://www.sem.samsung.com>, <http://www.semlcr.com>]

CONTENTS

Operation Notes	4	Operation Notes
Example of land Pattern Design	5	Example of land Pattern Design
Recommended Soldering Conditions	6	Recommended Soldering Conditions
General Structure	7	General Structure
General	8	General
Low ohms(RUT Series)	10	Low ohms (RUT Series)
Ultra Low ohms(RU Series)	12	Ultra Low ohms (RU Series)
Ultra Low Ohms(RUK Series)	14	Ultra Low Ohms (RUK Series)
Ultra Low Ohms(RJ Series)	16	Ultra Low Ohms (RJ Series)
Arrays(Convex Type)	18	Arrays (Convex Type)
Arrays(Concave Type)	20	Arrays (Concave Type)
Arrays(Flat Type)	22	Arrays (FlatType)
Anti-Sulfur Resistors	24	Anti-Sulfur Resistors
Anti-Sulfur Resistor Arrays(Convex Type)	26	Anti-Sulfur Resistor Arrays(Convex Type)
Anti-Sulfur Resistor Arrays(Concave Type)	28	Anti-Sulfur Resistor Arrays(Concave Type)
Anti-Sulfur Resistor Arrays (Flat Type)	30	Anti-Sulfur Resistor Arrays (Flat Type)
Automotive Anti-sulfur	32	Automotive Anti-sulfur
Automotive Anti-sulfur Arrays (Convex Type)	34	Automotive Anti-sulfur Arrays (Convex Type)
Attenuator	36	Attenuator
Characteristics Performance	38	Characteristics Performance
Packaging	40	Packaging
Standard Resistance Value	42	Standard Resistance Value

Operation Notes

Applications

- Chip resistors are designed for general electronic devices such as home appliances, computer, mobile communications, digital circuit, etc. If you require our products with high reliability-performing at more than 125°C or below -55°C - for medical equipments, aircrafts, high speed machines, military usage, and items that can affect human life or if you need to use in specific conditions (corrosive gas atmosphere like H₂S etc.), please contact us beforehand.
- Normal operation temperature ranges : -55°C ~+155°C
- Others (small sizes and flat type arrays) : -55°C ~+125°C
- Although resistor body is coated, sharp excessive impact should be avoided to prevent damages and adverse effects on characteristics (resistor value, open circuited, T.C.R.).

Mounting

Please give more attention not to press the chip owing to the nozzle's improper height when it is mounted on PCB. (Excessive pressure may cause exterior damage, change in resistance, circuit open, etc.)

Safety precautions

- These products are designed and produced for applying to the ordinary electronic equipments. (AV equipment, OA equipment, Telecommunication equipment, etc)
- Consult with our sales department before applying in the devices that require extremely high reliability such as medical equipments, transport equipments, aircrafts /spacecrafts, nuclear power controllers, fuel controllers, car equipments including car accessories and other safety devices.
- Following special environments, and such environmental conditions may affect the performance of the product. Please verify the performance and reliability thoroughly prior to use.
 - a) Using in various type of Liquid including water, oil, organic solvent and other chemicals.
 - b) Using in the places where the products are exposed to direct sunlight, sea wind, corrosive gases (including Cl, H₂S, NH₃, SO₂, NO₂), static electricity, electromagnetic waves and dusty air.
 - c) Using close to heat generating components or other flammable items.
 - d) Using in the places that is sealed or coated with resins or other coating materials after soldering.
 - e) Using in places subject to dew condensation.
- These products are not radiation resistant.
- The company is not responsible for any problems resulting from using of the products under the conditions not recommended herein.
- The company should notify any safety issues of the products to the customer. And the safety of the products should be monitored by the customer periodically.

Storage

To maintain proper quality of chip components, the following precautions are required for storage environment, method and period.

- Storage Environment
 - Make sure that the ambient temperature is within 5°C ~40°C and the ambient humidity is within 20~70%RH.
 - Chip components may be deformed, if the temperature of packaged components exceeds 40°C .
 - Do not store where the soldering properties can be deteriorated by harmful gas such as sulphurous gas, chlorine gas, etc.
 - Bulk packed chip components should be used as soon as the seal is opened, thus preventing the solderability from deteriorating.
 - The remaining unused chips should be put in the original bag and sealed again or store in a desiccator containing a desiccating agent.
- Storage Time Period
 - Stored chip components should be used within 6 months after receiving the components. If 6 months or more have elapsed, please check the solderability before actually using.

Cleaning

After Soldering Cleaning, soldering flux & Ionic cleaning liquid should be avoided on product.

If any possibility on product, please take a test before usage.

Caution for Chip Resistor Separation from PCB.

Chip resistor installation on PCB is a similar phenomenon on a chocolate chip on top of a cake. PCB has enough flexibility on outer force but Chip resistor can be defected without any bending. (By chip resistor use of Ceramic, solder, metal) Therefore, when separating a Chip resistor from a PCB, beware of any crack on the chip.

Others

- Manual work
 - Whenever separating chip resistor from PCB, do not re-use the chip resistor for circuit safety.
 - Electrical specification of chip resistors can be changed by soldering iron after separation.
 - Re-use of separated chip resistor should be prohibited.
- Do not use more than rated voltage. (Please check the contents of each product)

Example of Land Pattern Design

- When designing P.C.B, the shape and size of the solder lands must allow a proper amount of solder to form under the resistor. The amount of solder formed at the end terminations has direct effect on the possibility of chip crack. The more the amount of solder and stress, the more the possibilities of chip crack.

For Chip Type

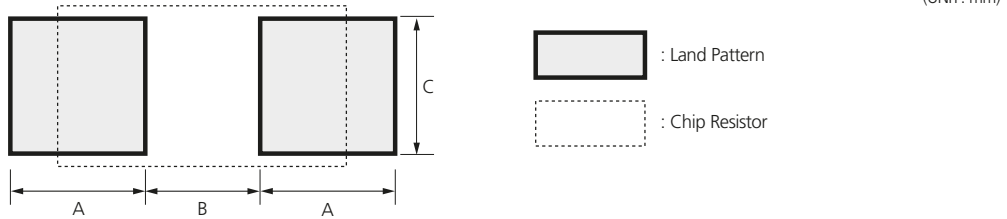

• Reflow Soldering(RC, RCA, RCM, RUT)

Type	A	B	2A+B	C
0402	0.17	0.20	0.54	0.18
0603	0.37	0.28	1.02	0.29
1005	0.6	0.5	1.7	0.5
1608	0.8	0.8	2.4	0.8
2012	0.9	1.4	3.2	1.2
3216	1.3	1.8	4.4	1.5
3225	1.3	1.8	4.4	2.4
5025	1.4	3.3	6.1	2.4
6432	1.4	4.6	7.4	3.0

• Reflow Soldering(RU, RUK)

Type	A	B	2A+B	C
1005	0.8	0.5	2.1	0.5
1608	0.8	0.5	2.1	0.8
2012	0.9	0.8	2.6	1.2
3216	1.7	1.2	4.6	1.4
3225	1.7	1.2	4.6	2.4
5025	2.15	1.8	6.1	2.6
6432	2.3	3.0	7.6	3.3

• Reflow Soldering(RJ, RW)

Type	A	B	2A+B	C
*0816	0.5	0.3	1.3	1.6
1220	0.7	0.4	1.8	2.0
1632	1.1	0.6	2.8	3.3
2037	1.4	1.2	4.0	3.8
*3264	2.0	1.6	5.6	6.5

For Array Type

• Convex type

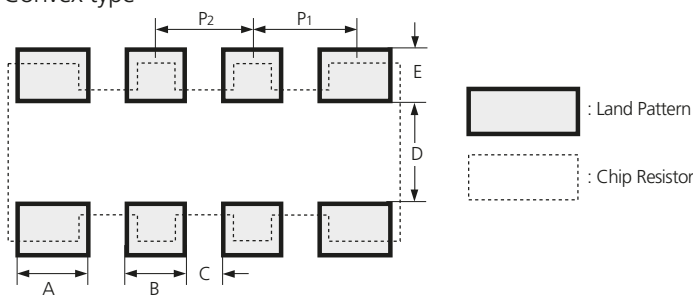

Type	A	B	C	D	E	P1	P2
062P	0.20	-	0.30	0.30	0.30	0.50	-
064P	0.20	0.20	0.20	0.30	0.30	0.40	0.40
10AT	0.4	-	0.25	0.5	0.5	0.65	-
102P	0.4	-	0.25	0.5	0.5	0.65	-
104P	0.5	0.3	0.2	0.5	0.5	0.55	0.5
164P	0.7	0.5	0.3	0.9	0.8	0.9	0.8

• Concave type

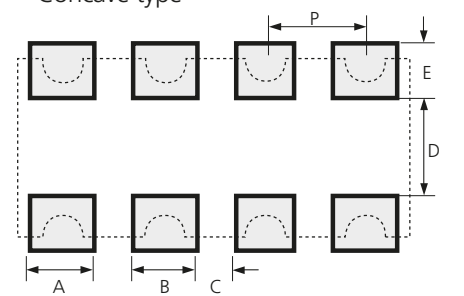

Type	A	B	C	D	E	P
102P	0.3	-	0.2	0.5	0.4	0.5
104P	0.3	0.3	0.2	0.5	0.4	0.5

- This is the recommended land pattern for designing PCB. This pattern does not guarantee any characteristic of other product.

The specifications and designs contained herein may be subject to change without notice. Please contact our sales representatives or product engineers before order.

Operation Notes

Example of land Pattern Design

Recommended Soldering Conditions

General Structure

General

Low ohms (RUT Series)

Ultra Low ohms (RU Series)

Ultra Low Ohms (RUK Series)

Ultra Low Ohms (RJ Series)

Arrays (CONVEX Type)

Arrays (CONCAVE Type)

Arrays (FLAT Type)

Anti-Sulfur Resistors

Anti-Sulfur Resistor Arrays(Convex Type)

Anti-Sulfur Resistor Arrays(Concave Type)

Anti-Sulfur Resistor Arrays (Flat Type)

Automotive Anti-sulfur

Automotive Anti-sulfur Arrays (Convex Type)

Attenuator

Characteristics Performance

Packaging

Standard Resistance Value

Recommended Soldering Conditions

Abstract

- There are 3 soldering methods.
 - Flow(wave) soldering.
 - Reflow soldering. (Reflow soldering is broadly divided into the total heating method and local heating method.)
 - Iron soldering.

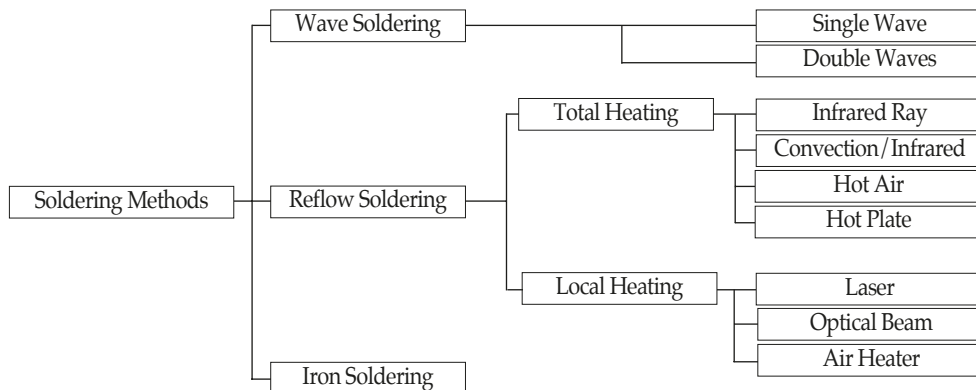

Since Chip resistors come into direct contact with melted solder during soldering, it is exposed to potential mechanical stress caused by the sudden temperature change. The chip resistors may also be subject to silver migration and flux contamination.

Flow(wave) Soldering

- Features

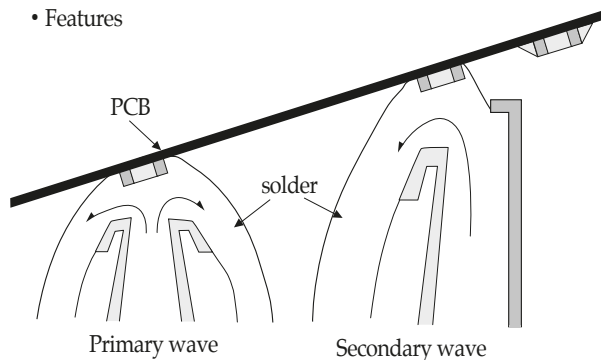

There are two types of soldering methods in flow(wave) soldering. One is single wave soldering, and the other is a double waves soldering. However, double waves soldering is mainly used. This method is designed for continuous and multiple dipping process by using primary and secondary wave, having completely different waveforms and characteristics.

With the primary wave, a comparatively strong jet flow is used to remove the flux gas and to solder.

With the secondary wave, it is used to remove excessive solder.

With the primary wave, the solder flows into a very small gap between components and air bubbles remaining on the soldered joint are removed.

With the secondary wave, the peel back is used to prevent bridging.

- Preheating

If a chip component is heated suddenly during soldering, it may crack by the thermal shock caused by the temperature difference between the surface and the inside of the chip. To prevent this, a full preheating is necessary. In case of wave soldering, the temperature difference between solder and surface of the component should be kept within 150°C. Also when cooling is done by dipping into solvent, care should be taken to keep the temperature difference within 150°C.

- Standard Soldering Condition

Soldering must be carried out without exceeding the approved soldering temperature and time shown within the shaded area of the graph at right. An excessively long soldering time or high soldering temperature results in leaching of outer terminations. When a PCB is warped, mechanical stress applied to the chip will be increased and might cause chip crack, especially if there is a big amount of solder on the chip. So, care should be taken not to use excessive amount of solder on the PCB.

For the flow(wave) soldering, the solder amount can be controlled by land size.

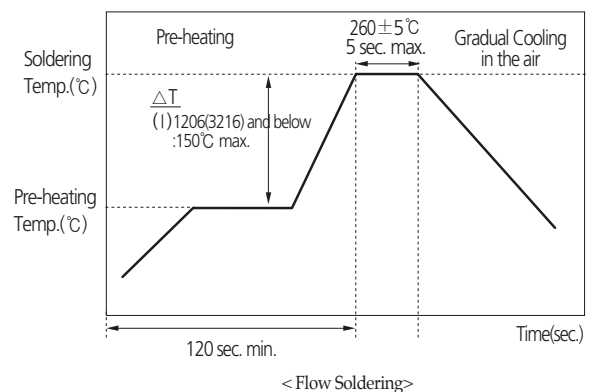

Reflow Soldering

• Pre-heating and cooling

In the reflow soldering method, a full pre-heating at the proper temperature is necessary to dry and activate solder paste. Tomb-stoning can be reduced by preheating at 150~180°C for more than 1 minute. Also when cooling is done by dipping into solvent, care should be taken to keep the temperature difference within 150°C.

• Standard Reflow Soldering Condition

Soldering must be carried out without exceeding the approved soldering temperature and time shown within the shaded area of the right graph. This prevents the terminations from leaching and characteristics from deteriorating. When soldering is repeated, the allowed time is the accumulated time.

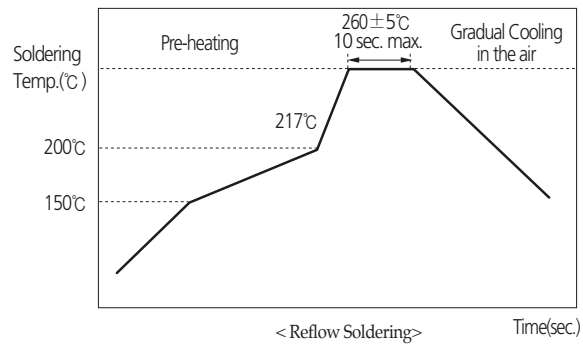

• Standard solder amount

When a PCB is warped, mechanical stress applied to the chip should be reduced, and to do so, care should be taken not to use excessive amount of solder on the PCB. In the case of the reflow method, the thickness of the coated solder paste is controlled to prevent excessive solder. The thickness of solder paste should be 100~300µm.

• Tombstoning and Prevention

When reflow soldering, or especially vapor phase soldering (VPS), small chip components of less than RC3216 type may break away from solder and stand on end. This is commonly known as tombstoning or the Manhattan phenomenon.

- Preventing tombstoning

Keep land size as small as possible.

Keep the pre-heating conditions properly

(Pre-heating temperature : 150 ~ 180°, Pre-heating time : more than 1 min.)

Keep the solder paste quantity not too much and uniform for every lands.

Keep the position of chips properly.

At around the soldering temperature, keep minimum difference of the temperature between the electrodes of a chip.

Iron Soldering

When using a soldering iron or any other soldering operation, the permissible temperature and time should not exceed that of the reflow soldering. In order to prevent the external terminations from leaching and characteristics from deteriorating, the tip of the soldering iron should not touch the chip component (ceramic element, resin case, etc.). Soldering with a soldering iron and correcting with a soldering iron can be performed right under following conditions.

Item	Condition
Temperature at tip	350°C Max.
Soldering iron output	20-Watt Max.
End of soldering iron	∅ 3mm Max.
Note	Do not directly touch the chip by the tip of the iron.

General Structure of the Chip Resistor

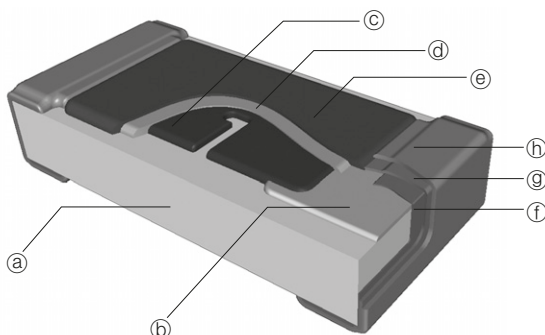

No.	Name	Main Substance
(a)	Ceramic Substrate	Al ₂ O ₃
(b)	Inner Electrode	Ag
(c)	Resistor	RuO ₂
(d)	Glass Coat	Bi ₂ O ₃ , SiO ₂
(e)	Protective Coat	Polymer / Glass
(f)	Terminal Coat	Ni-Cr Alloy /Ag
(g)	Ni Plate	Ni
(h)	Sn Plate	Sn

Operation Notes

Example of land Pattern Design

Recommended Soldering Conditions

General Structure

General

Low ohms (RUT Series)

Ultra Low ohms (RU Series)

Ultra Low Ohms (RUK Series)

Ultra Low Ohms (RJ Series)

Arrays (CONVEX Type)

Arrays (CONCAVE Type)

Arrays (FLAT Type)

Anti-Sulfur Resistors

Anti-Sulfur Resistor Arrays(Convex Type)

Anti-Sulfur Resistor Arrays(Concave Type)

Anti-Sulfur Resistor Arrays (Flat Type)

Automotive Anti-sulfur

Automotive Anti-sulfur Arrays (Convex Type)

Attenuator

Characteristics Performance

Packaging

Standard Resistance Value

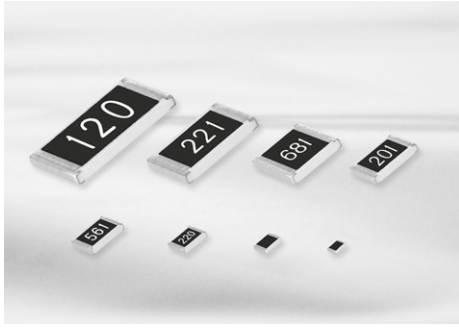

Feature

- Very small, thin, and light weight.
- Both flow and reflow soldering are applicable.
- Very low inductance.
- Suitable size and packaging for surface mount assembly.
- Lead-free terminal.
- PbO(lead oxide) is included in the glass of our product which is prescribed on RoHS appendix as an exemption.

Application

- General purpose.
- Home Appliances.
(DVD, Digital TV, Digital Camera, Audio, Tunner).
- For Computers & Communications.
(Notebook, Memory Module, Mobile, Network Equipment, etc).

Structure and Dimensions

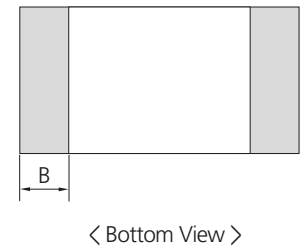
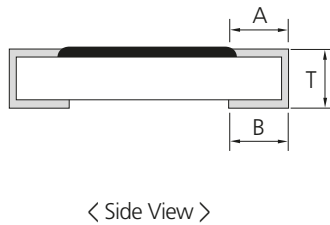
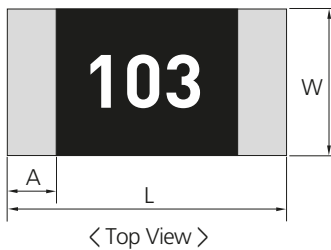

(UNIT: mm)

Type	SIZE(Inch)	L	W	T	A	B
RC0402	01005	0.40 ±0.02	0.20 ±0.02	0.13 ±0.02	0.10 ±0.03	0.10 ±0.03
RC0603	0201	0.60 ±0.03	0.30 ±0.03	0.23 ±0.03	0.10 ±0.05	0.15 ±0.05
RC1005	0402	1.00 ±0.05	0.50 ±0.05	0.35 ±0.05	0.20 ±0.10	0.25 ±0.10
RC1608	0603	1.60 ±0.10	0.80 ±0.10	0.45 ±0.10	0.30 ±0.20	0.35 ±0.10
RC2012	0805	2.00 ±0.20	1.25 ±0.15	0.55 ±0.10	0.40 ±0.20	0.35 ±0.20
RC3216	1206	3.20 ±0.20	1.60 ±0.15	0.55 ±0.10	0.45 ±0.20	0.40 ±0.20
RC3225	1210	3.20 ±0.20	2.55 ±0.20	0.55 ±0.10	0.45 ±0.20	0.40 ±0.20
RC5025	2010	5.00 ±0.20	2.50 ±0.20	0.55 ±0.10	0.60 ±0.20	0.60 ±0.20
RC6432	2512	6.30 ±0.20	3.20 ±0.20	0.55 ±0.10	0.60 ±0.20	0.60 ±0.20

- ※ 0402 and smaller size don't have marking on top of the chips.
- ※ 0603 4-digit models(E-96 series) don't have marking on top of the chips.

Parts Numbering System

- The part number system shall be in the following format

RC	2012 Dimension & Size Code	J Tolerance	100 Resistance Value	CS Packaging Code
RC: Chip Resistor	0402: 0.4×0.2(mm) - 01005(inch) 0603: 0.6×0.3(mm) - 0201(inch) 1005: 1.0×0.5(mm) - 0402(inch) 1608: 1.6×0.8(mm) - 0603(inch) 2012: 2.0×1.2(mm) - 0805(inch) 3216: 3.2×1.6(mm) - 1206(inch) 3225: 3.2×2.5(mm) - 1210(inch) 5025: 5.0×2.5(mm) - 2010(inch) 6432: 6.4×3.2(mm) - 2512(inch)	D : ±0.5% F : ±1% G : ±2% J : ±5% ※ Jumper : J	3 or 4 digits coding system (IEC coding system) 3digits (E-24 series) 4digits (E-96 series) ※ Jumper : '000'	CS: Tape Packaging 7" ES: Tape Packaging 10" AS: Tape Packaging 13"

Specification

Type	Size (inch)	Rated Power (W)	Rated Voltage (V)	Max Working Voltage (V)	Tolerance (%)	Resistance Range (Ω)	T.C.R (ppm/°C)	Working Temp. (°C)	Rated Ambient Temp. (°C)	Moisture Level
RC 0402	01005	1/32	$\sqrt{P \times R}$ P: Rated Power(W) R: Resistance(Ω)	15	±1(F) ±2(G) ±5(J)	1 ~ 99 100 ~ 1M	±300 ±250	-55~125	70	Level 1
RC 0603	0201	1/20		25		1 ~ 9.9 10 ~ 10M				
RC 1005	0402	1/16		50	±0.5(D) ±1(F) ±2(G) ±5(J)	1 ~ 9.9 10 ~ 10M	±300 ±100	-55~155		
RC 1608	0603	1/10		50						
RC 2012	0805	1/8		150						
RC 3216	1206	1/4		200						
RC 3225	1210	1/3		200						
RC 5025	2010	2/3		200						
RC 6432	2512	1		200						

• Please contact our sales representatives or engineers for other specifications

Power Derating Curve

The rated power is the maximum continuous loading power at 70°C ambient temperature.

For ambient temperature above 70°C, the loading power follows the below power derating curve.

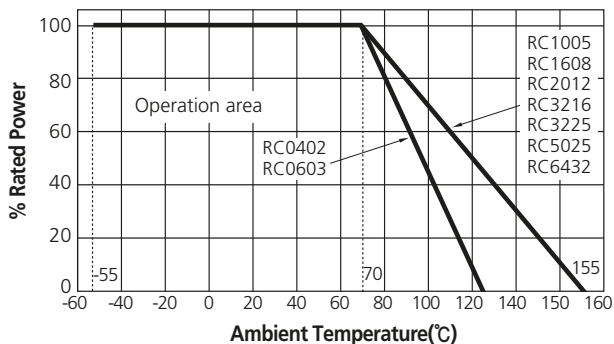

Marking

• 3 digits indication (E-24 series)

- Left 2 digits represent significant figures.
- Last 1 digit represents exponential number of 10.
- Example: **103**
Left 2 digits: 10
Last 1 digit: 3
 $103 = 10 \times 10^3 \Omega$
 $= 10000 \Omega = 10k\Omega$



No marking types :
RC0402, RC0603,
RC1005

• 4 digits indication (E-96 series)

- Left 3 digits represent significant figures.
- Last 1 digit represents exponential number of 10.
- Example: **1002**
Left 3 digits: 100
Last 1 digit: 2
 $1002 = 100 \times 10^2 \Omega$
 $= 10000 \Omega = 10k\Omega$



No marking types :
RC0402, RC0603,
RC1005, RC1608

Jumper Rating

Type	Size (inch)	Rated Current (A)	Resistance (Ω)
RC0402	01005	0.5	0.05 Max
RC0603	0201		
RC1005	0402	1.0	
RC1608	0603		
RC2012	0805	2.0	
RC3216	1206		
RC3225	1210		
RC5025	2010		
RC6432	2512		

IEC Code System (E-96, E-24)

E-96	E-24	E-96	E-24	E-96	E-24	E-96	E-24
100	10	178		316		562	56
102		182	18	324	33	576	
105		187		332		590	
107		191		340		604	
110	11	196		348		619	
113		200	20	357	36	634	62
115		205		365		649	
118		210		374		665	
121	12	215		383	39	681	68
124		221	22	392		698	
127		226		402		715	
130	13	232		412		732	
133		237		422		750	75
137		243	24	432	43	768	
140		249		442		787	
143		255		453		806	
147		261		464		825	
150	15	267		475	47	845	82
154		274	27	487		866	
158		280		499		887	
162	16	287		511	51	909	
165		294		523		931	91
169		301	30	536		953	
174		309		549		976	

Operation Notes

Example of land Pattern Design

Recommended Soldering Conditions

General Structure

General

Low ohms (RUT Series)

Ultra Low ohms (RU Series)

Ultra Low Ohms (RUK Series)

Ultra Low Ohms (RJ Series)

Arrays (CONVEX Type)

Arrays (CONCAVE Type)

Arrays (FLAT Type)

Anti-Sulfur Resistors

Anti-Sulfur Resistor Arrays(Convex Type)

Anti-Sulfur Resistor Arrays(Concave Type)

Anti-Sulfur Resistor Arrays (Flat Type)

Automotive Anti-sulfur

Automotive Anti-sulfur Arrays (Convex Type)

Attenuator

Characteristics Performance

Packaging

Standard Resistance Value

Low Ohms(RUT Series)

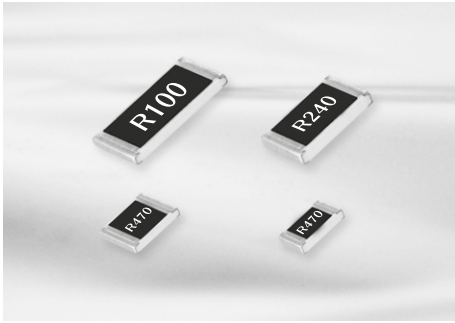

Feature

- Under 1 ohms, precision resistance.
- Both flow and reflow soldering are applicable.
- High Power with Low TCR.
- 100% Lead Free Products (PbO not used).
- RoHS Compliant.

Application

- Current Sensing.
- PCM of Battery Pack.
- Power supplying part, DC power charger, adapter.
- Mobile Phone, HDD, DSC, LCD.

Structure and Dimensions

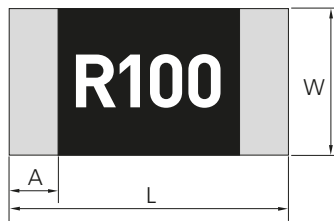

< Top View >

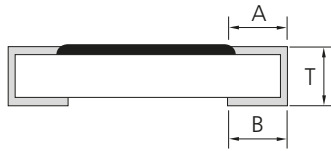

< Side View >

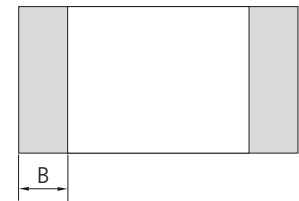

< Bottom View >

(UNIT: mm)

Type	SIZE(Inch)	L	W	T	A	B
RUT1005	0402	1.00±0.05	0.50±0.05	0.35±0.05	0.20±0.10	0.25±0.10
RUT1608	0603	1.60±0.10	0.80±0.10	0.45±0.10	0.30±0.20	0.35±0.10
RUT2012	0805	2.00±0.20	1.25±0.15	0.55±0.10	0.40±0.20	0.35±0.20
RUT3216	1206	3.20±0.20	1.60±0.15	0.55±0.10	0.45±0.20	0.40±0.20
RUT3225	1210	3.20±0.20	2.55±0.20	0.55±0.10	0.45±0.20	0.40±0.20
RUT5025	2010	5.00±0.20	2.50±0.20	0.55±0.10	0.60±0.20	0.60±0.20
RUT6432	2512	6.30±0.20	3.20±0.20	0.55±0.10	0.60±0.20	0.60±0.20

Parts Numbering System

- The part number system shall be in the following format

RUT Code Designation	2012 Dimension & Size Code	J Tolerance	R100 Resistance Value	CS Packaging Code
RUT: Current Sensing Resistor Top Mounting (Face-up)	1005: 1.0×0.5(mm) - 0402(inch) 1608: 1.6×0.8(mm) - 0603(inch) 2012: 2.0×1.2(mm) - 0805(inch) 3216: 3.2×1.6(mm) - 1206(inch) 3225: 3.2×2.5(mm) - 1210(inch) 5025: 5.0×2.5(mm) - 2010(inch) 6432: 6.4×3.2(mm) - 2512(inch)	F: ±1% G: ±2% J: ±5%	4-digit coding system	CS: Tape & Reel 7" ES: Tape & Reel 10" AS: Tape & Reel 13"

Specification

Type	Size (inch)	Rated Power (W)	Resistance (Ω)	T.C.R (ppm/°C)	Rated Current (A)	Rated Ambient Temperature (°C)	Working Temperature (°C)
RUT1005	0402	1/10	0.1~0.976	±150	$\sqrt{P/R}$ P: Rated Power(W) R: Resistance(Ω)	70	-55~+155
RUT1608	0603	1/8					
RUT2012	0805	1/4					
RUT3216	1206	1/3					
RUT3225	1210	1/2					
RUT5025	2010	2/3					
RUT6432	2512	1					

• Please contact our sales representatives or engineers for other specifications

Power Derating Curve

The rated power is the maximum continuous loading power at 70°C ambient temperature. For ambient temperature above 70°C, the loading power follows the below power derating curve.

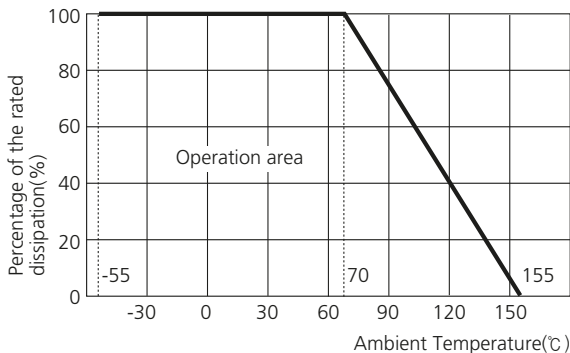

Marking

4 digits indication

- R means decimal point.
- Other digits represent the significant value.
- Example : R100
 $R100 = .100 = 0.100\Omega$
 $= 0.1\Omega$ or $100m\Omega$



Resistance Value Table

Code	Value (Ω)	Tol (%)	Code	Value (Ω)	Tol (%)	Code	Value (Ω)	Tol (%)	Code	Value (Ω)	Tol (%)	Code	Value (Ω)	Tol (%)	Code	Value (Ω)	Tol (%)
R100	0.1	±1,±5	R154	0.154	±1	R226	0.226	±1	R330	0.33	±1,±5	R470	0.47	±1,±5	R680	0.68	±1,±5
R102	0.102	±1	R158	0.158	±1	R232	0.232	±1	R332	0.332	±1	R475	0.475	±1	R681	0.681	±1
R105	0.105	±1	R160	0.16	±1,±5	R237	0.237	±1	R340	0.34	±1	R487	0.487	±1	R698	0.698	±1
R107	0.107	±1	R162	0.162	±1	R240	0.24	±1,±5	R348	0.348	±1	R499	0.499	±1	R715	0.715	±1
R110	0.11	±1,±5	R165	0.165	±1	R243	0.243	±1	R357	0.357	±1	R510	0.51	±1,±5	R732	0.732	±1
R113	0.113	±1	R169	0.169	±1	R249	0.249	±1	R360	0.36	±1,±5	R511	0.511	±1	R750	0.75	±1,±5
R115	0.115	±1	R174	0.174	±1	R255	0.255	±1	R365	0.365	±1	R523	0.523	±1	R768	0.768	±1
R118	0.118	±1	R178	0.178	±1	R261	0.261	±1	R374	0.374	±1	R536	0.536	±1	R787	0.787	±1
R120	0.12	±1,±5	R180	0.180	±1,±5	R267	0.267	±1	R383	0.383	±1	R549	0.549	±1	R806	0.806	±1
R121	0.121	±1	R182	0.182	±1	R270	0.27	±1,±5	R390	0.39	±1,±5	R560	0.56	±1,±5	R820	0.82	±1,±5
R124	0.124	±1	R187	0.187	±1	R274	0.274	±1	R392	0.392	±1	R562	0.562	±1	R825	0.825	±1
R127	0.127	±1	R191	0.191	±1	R280	0.28	±1	R402	0.402	±1	R576	0.576	±1	R845	0.845	±1
R130	0.13	±1,±5	R196	0.196	±1	R287	0.287	±1	R412	0.412	±1	R590	0.59	±1	R866	0.866	±1
R133	0.133	±1	R200	0.200	±1,±5	R294	0.294	±1	R422	0.422	±1	R604	0.604	±1	R887	0.887	±1
R137	0.137	±1	R205	0.205	±1	R300	0.3	±1,±5	R430	0.43	±1,±5	R619	0.619	±1	R909	0.909	±1
R140	0.14	±1	R210	0.21	±1	R301	0.301	±1	R432	0.432	±1	R620	0.62	±1,±5	R910	0.91	±1,±5
R143	0.143	±1	R215	0.215	±1	R309	0.309	±1	R442	0.442	±1	R634	0.634	±1	R931	0.931	±1
R147	0.147	±1	R220	0.22	±1,±5	R316	0.316	±1	R453	0.453	±1	R649	0.649	±1	R953	0.953	±1
R150	0.15	±1,±5	R221	0.221	±1	R324	0.324	±1	R464	0.464	±1	R665	0.665	±1	R976	0.976	±1

- Operation Notes
- Example of land Pattern Design
- Recommended Soldering Conditions
- General Structure
- General
- Low ohms (RUT Series)
- Ultra Low ohms (RU Series)
- Ultra Low Ohms (RUK Series)
- Ultra Low Ohms (RJ Series)
- Arrays (CONVEX Type)
- Arrays (CONCAVE Type)
- Arrays (FLAT Type)
- Anti-Sulfur Resistors
- Anti-Sulfur Resistor Arrays(Convex Type)
- Anti-Sulfur Resistor Arrays(Concave Type)
- Anti-Sulfur Resistor Arrays (Flat Type)
- Automotive Anti-sulfur
- Automotive Anti-sulfur Arrays (Convex Type)
- Attenuator
- Characteristics Performance
- Packaging
- Standard Resistance Value

Ultra Low Ohms(RU Series)

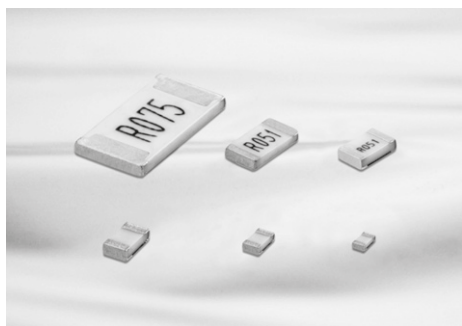

Feature

- Thick Film Type Ultra Low Ohm Resistor.
- High Precision Reliability.
- High Power with Low TCR.
- 100% Lead Free Products (PbO not used).
- RoHS Compliant.

Application

- Current Sensing.
- PCM of Battery Pack.
- Power supplying part, DC power charger, Adapter.
- Mobile Phone, Mobile PC, Note PC, HDD, DSC, LCD.

Structure and Dimensions

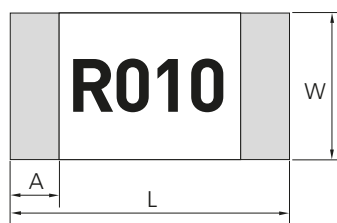

< Top View >

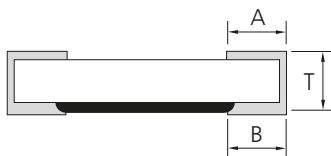

< Side View >



< Bottom View >

(UNIT: mm)

Type	SIZE(Inch)	L	W	T	A	B
RU1005	0402	1.00±0.05	0.50±0.05	0.35±0.05	0.25±0.15	0.25±0.15
RU1608	0603	1.60±0.10	0.80±0.10	0.45±0.10	0.30±0.20	R ≤ 0.05 : 0.50 ± 0.20 R > 0.05 : 0.35 ± 0.20
RU2012	0805	2.00±0.20	1.25±0.15	0.55±0.10	0.40±0.20	R ≤ 0.05 : 0.65 ± 0.20 R > 0.05 : 0.40 ± 0.20
RU3216	1206	3.20±0.20	1.60±0.15	0.60±0.10	0.45±0.20	R ≤ 0.05 : 0.90 ± 0.20 R > 0.05 : 0.60 ± 0.20
RU3225	1210	3.20±0.20	2.55±0.20	0.60±0.10	0.45±0.20	R ≤ 0.05 : 1.20 ± 0.20 R > 0.05 : 0.75 ± 0.20
RU5025	2010	5.00±0.20	2.50±0.20	0.60±0.10	0.50±0.20	R ≤ 0.05 : 1.50 ± 0.20 R > 0.05 : 0.90 ± 0.20
RU6432	2512	6.30±0.20	3.20±0.20	0.60±0.10	0.50±0.20	R ≤ 0.05 : 1.90 ± 0.20 R > 0.05 : 1.10 ± 0.25

Parts Numbering System

- The part number system shall be in the following format

RU	2012	F	R051	CS
Code Designation	Dimension & Size Code	Tolerance	Resistance Value	Packaging Code
RU : Current sensing resistor	1005: 1.0×0.5(mm) - 0402(inch)	F: ±1% G: ±2% J: ±5%	4-digit coding system	CS: Tape & Reel 7"
	1608: 1.6×0.8(mm) - 0603(inch)			ES: Tape & Reel 10"
	2012: 2.0×1.2(mm) - 0805(inch)			AS: Tape & Reel 13"
	3216: 3.2×1.6(mm) - 1206(inch)			
	3225: 3.2×2.5(mm) - 1210(inch)			
	5025: 5.0×2.5(mm) - 2010(inch)			
	6432: 6.4×3.2(mm) - 2512(inch)			

Specification

Type	Size (inch)	Rated Power (W)	Resistance (Ω)	T.C.R (ppm/°C)	Rated Current (A)	Rated Ambient Temperature (°C)	Working Temperature (°C)
RU1005	0402	1/8	0.02~0.1	R<0.047: ± 500 R≥0.047: ± 150	$\sqrt{P/R}$ P: Rated Power(W) R: Resistance(Ω)	70	-55 ~ +155
RU1608	0603	1/4	0.01~0.1	R≤0.025: ± 600 R<0.033: ± 400 R≥0.033: ± 150			
RU2012	0805	1/3		R≤0.025: ± 500 R<0.033: ± 350 R≥0.033: ± 150			
RU3216	1206	1/2					
RU3225	1210	2/3					
RU5025	2010	3/4					
RU6432	2512	1					

• Please contact our sales representatives or engineers for other specifications

Power Derating Curve

The rated power is the maximum continuous loading power at 70°C ambient temperature. For ambient temperature above 70°C, the loading power follows the below power derating curve.

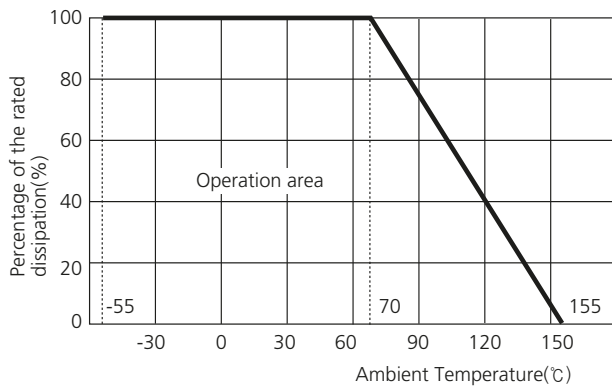

Marking

4-digit Coding System

- R means decimal point.
- Other digits represent the significant value.
- Example : R010
R010 = .010 = 0.010Ω
= 0.01Ω or 10mΩ



Resistance Value Table

Code	Value (Ω)	Tol (%)	Code	Value (Ω)	Tol (%)	Code	Value (Ω)	Tol (%)	Code	Value (Ω)	Tol (%)
R010	0.010	±1, ±5	R020	0.020	±1, ±5	R039	0.039	±1, ±5	R062	0.062	±1, ±5
R011	0.011	±1, ±5	R022	0.022	±1, ±5	R040	0.040	±1, ±5	R068	0.068	±1, ±5
R012	0.012	±1, ±5	R024	0.024	±1, ±5	R043	0.043	±1, ±5	R075	0.075	±1, ±5
R013	0.013	±1, ±5	R027	0.027	±1, ±5	R047	0.047	±1, ±5	R082	0.082	±1, ±5
R015	0.015	±1, ±5	R030	0.030	±1, ±5	R050	0.050	±1, ±5	R091	0.091	±1, ±5
R016	0.016	±1, ±5	R033	0.033	±1, ±5	R051	0.051	±1, ±5	R100	0.100	±1, ±5
R018	0.018	±1, ±5	R036	0.036	±1, ±5	R056	0.056	±1, ±5			

The specifications and designs contained herein may be subject to change without notice. Please contact our sales representatives or product engineers before order.

Operation Notes

Example of land Pattern Design

Recommended Soldering Conditions

General Structure

General

Low ohms (RUT Series)

Ultra Low ohms (RU Series)

Ultra Low Ohms (RUK Series)

Ultra Low Ohms (RJ Series)

Arrays (CONVEX Type)

Arrays (CONCAVE Type)

Arrays (FLAT Type)

Anti-Sulfur Resistors

Anti-Sulfur Resistor Arrays(Convex Type)

Anti-Sulfur Resistor Arrays(Concave Type)

Anti-Sulfur Resistor Arrays (Flat Type)

Automotive Anti-sulfur

Automotive Anti-sulfur Arrays (Convex Type)

Attenuator

Characteristics Performance

Packaging

Standard Resistance Value

Ultra Low Ohms(RUK Series)

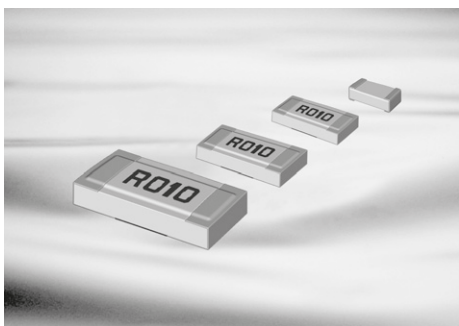

Feature

- Thick Film Type Ultra Low Ohm Resistor.
- High Precision Reliability.
- High Power with Very Low TCR.
- 100% Lead Free Products (PbO not used).
- RoHS Compliant.

Application

- Current Sensing.
- PCM of Battery Pack.
- Power supplying part, DC power charger, adapter.
- Mobile Phone, Mobile PC, Note PC, HDD, DSC, LCD.

Structure and Dimensions

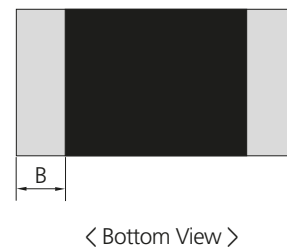
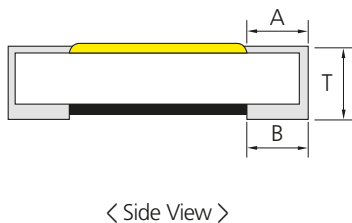
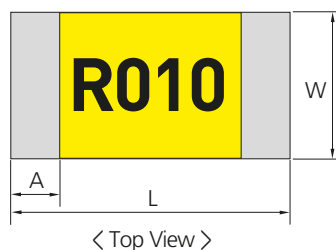

(UNIT: mm)

Type	SIZE(Inch)	L	W	T	A	B
RUK1608	0603	1.60±0.10	0.80±0.10	R<15m:0.55±0.10 R≥15m:0.45±0.10	0.35±0.20	0.40±0.20
RUK2012	0805	2.00±0.20	1.25±0.15	R<15m:0.60±0.10 R≥15m:0.55±0.10	0.40±0.20	0.55±0.20
RUK3216	1206	3.20±0.20	1.60±0.15	R<15m:0.65±0.10 R≥15m:0.60±0.10	0.45±0.20	0.90±0.20
RUK6432	2512	6.30±0.20	3.20±0.20	R<15m:0.65±0.10 R≥15m:0.60±0.10	1.15±0.20	0.90±0.20

Parts Numbering System

- The part number system shall be in the following format

RUK	1608	F	R010	CS
Code Designation	Dimension & Size Code	Tolerance	Resistance Value	Packaging Code
RUK : Current Sensing Resistor Low TCR	1608: 1.6×0.8(mm) - 0603(inch) 2012: 2.0×1.2(mm) - 0805(inch) 3216: 3.2×1.6(mm) - 1206(inch) 6432: 6.4×3.2(mm) - 2512(inch)	F: ±1% G: ±2% J: ±5%	4-digits coding system	CS: Tape & Reel 7" ES: Tape & Reel 10" AS: Tape & Reel 13"

Specification

Type	Size (inch)	Rated Power (W)	Resistance (Ω)	T.C.R (ppm/°C)	Rated Current (A)	Rated Ambient Temperature (°C)	Working Temperature (°C)
RUK1608	0603	1/2	0.010 ~ 0.030	± 100	$\sqrt{P/R}$ P: Rated Power(W) R: Resistance(Ω)	70	-55 ~ +155
RUK2012	0805	1/2	0.007 ~ 0.009	± 250			
			0.010 ~ 0.030	± 100			
RUK3216	1206	1	0.010 ~ 0.030	± 100			
RUK6432	2512	1	0.007 ~ 0.009	± 500			
			0.010 ~ 0.030	± 100			

- Please contact our sales representatives or engineers for other specifications

Power Derating Curve

The rated power is the maximum continuous loading power at 70°C ambient temperature. For ambient temperature above 70°C, the loading power follows the below power derating curve.

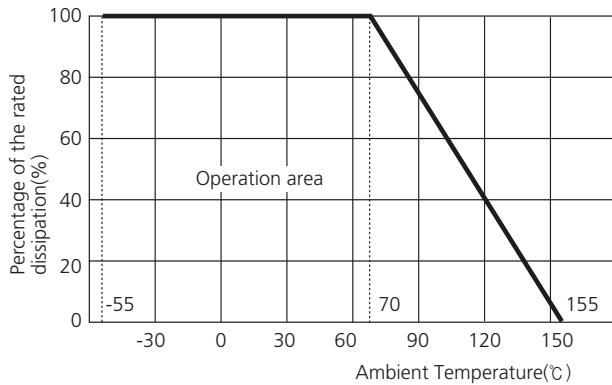

Marking

4-digits coding system

- R means decimal point.
- Other digits represent significant value.
- Example : R010
 $R010 = .010 = 0.010\Omega$
 $= 0.01\Omega$ or $10m\Omega$



Resistance Value Table

Code	Value(Ω)	Tol(%)	Code	Value(Ω)	Tol(%)
R010	0.010	±1, ±5	R018	0.018	±1, ±5
R011	0.011	±1, ±5	R020	0.020	±1, ±5
R012	0.012	±1, ±5	R022	0.022	±1, ±5
R013	0.013	±1, ±5	R024	0.024	±1, ±5
R015	0.015	±1, ±5	R027	0.027	±1, ±5
R016	0.016	±1, ±5	R030	0.030	±1, ±5

The specifications and designs contained herein may be subject to change without notice. Please contact our sales representatives or product engineers before order.

Operation Notes

Example of land Pattern Design

Recommended Soldering Conditions

General Structure

General

Low ohms (RUT Series)

Ultra Low ohms (RU Series)

Ultra Low Ohms (RUK Series)

Ultra Low Ohms (RJ Series)

Arrays (CONVEX Type)

Arrays (CONCAVE Type)

Arrays (FLAT Type)

Anti-Sulfur Resistors

Anti-Sulfur Resistor Arrays(Convex Type)

Anti-Sulfur Resistor Arrays(Concave Type)

Anti-Sulfur Resistor Arrays (Flat Type)

Automotive Anti-sulfur

Automotive Anti-sulfur Arrays (Convex Type)

Attenuator

Characteristics Performance

Packaging

Standard Resistance Value

Ultra Low Ohms(RJ Series)

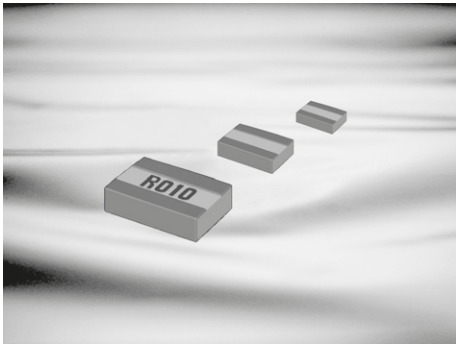

Feature

- Thick Film Wide Terminal Type.
- High Precision Reliability.
- High Power with Low TCR.
- 100% Lead Free Products (PbO not used).
- RoHS Compliant.

Application

- Current Sensing.
- PCM of Battery Pack.
- DC Power Charger, Adapter.
- Mobile Phone, Mobile PC, HDD, DSC, LCD.

Structure and Dimensions



< Top View >

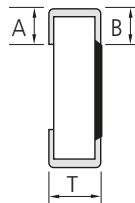

< Side View >

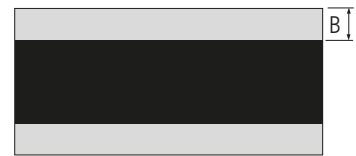

< Bottom View >

(UNIT: mm)

Type	SIZE(Inch)	L	W	T	A	B
RJ0816	0306	0.80±0.10	1.60±0.10	0.45±0.15	0.25±0.15	0.30±0.15
RJ1220	0508	1.25±0.10	2.00±0.10	0.55±0.15	0.30±0.15	0.35±0.15
RJ1632	0612	1.60±0.15	3.20±0.15	0.55±0.15	0.35±0.20	0.40±0.20
RJ2037	0815	2.00±0.15	3.75±0.15	0.55±0.15	0.45±0.20	0.55±0.20
RJ3264	1225	3.20±0.20	6.40±0.20	0.55±0.15	0.60±0.20	0.60±0.20

Parts Numbering System

- The part number system shall be in the following format

RJ	0816	F	R010	CS
Code Designation	Dimension & Size Code	Tolerance	Resistance Value	Packaging Code

RJ : Thick Film Wide Terminal CSR	0816 : 0.8×1.6(mm) - 0306(inch)	F: ±1% G: ±2% J: ±5%	4-digits coding system	CS: Tape & Reel 7"
	1220 : 1.2×2.0(mm) - 0508(inch)			ES: Tape & Reel 10"
	1632 : 1.6×3.2(mm) - 0612(inch)			AS: Tape & Reel 13"
	2037 : 2.0×3.7(mm) - 0815(inch)			
	3264 : 3.2×6.4(mm) - 1225(inch)			

Specification

Type	Size (inch)	Rated Power (W)	Resistance (Ω)	T.C.R (ppm/°C)	Rated Current (A)	Rated Ambient Temperature (°C)	Working Temperature (°C)
RJ0816 ⁽¹⁾	0306	1/2	0.005 ~ 0.02	± 100	$\sqrt{P/R}$ P: Rated Power(W) R: Resistance(Ω)	70	-55 ~ +155
RJ1220	0508	1	0.005 ~ 0.02				
		1/2	0.021 ~ 0.05	-200 ~ 0			
RJ1632	0612	1	0.005 ~ 0.02	± 100			
		3/4	0.021 ~ 0.05	-200 ~ 0			
RJ2037	0815	1	0.005 ~ 0.02	± 100			
RJ3264 ⁽¹⁾	1225	2	0.005 ~ 0.02				

(1) RJ0816, RJ3264 are under development (sample available)

• Please contact our sales representatives or engineers for other specifications

Power Derating Curve

The rated power is the maximum continuous loading power at 70°C ambient temperature. For ambient temperature above 70°C, the loading power follows the below power derating curve.

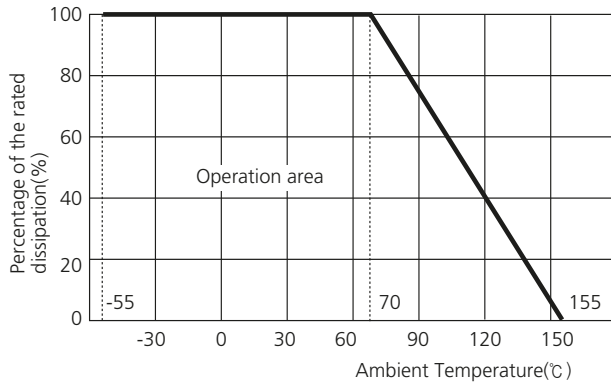

Marking

4-digits coding system

- R means decimal point.
- Other digits represent significant value.
- Example : R010
R010 = .010 = 0.010Ω
= 0.01Ω or 10mΩ

R010

Resistance Value Table

Code	Value (Ω)	Tol (%)	Code	Value (Ω)	Tol (%)	Code	Value (Ω)	Tol (%)
R005	0.005	±1, ±5	R013	0.013	±1, ±5	R030	0.030	±1, ±5
R006	0.006	±1, ±5	R015	0.015	±1, ±5	R033	0.033	±1, ±5
R007	0.007	±1, ±5	R016	0.016	±1, ±5	R036	0.036	±1, ±5
R008	0.008	±1, ±5	R018	0.018	±1, ±5	R039	0.039	±1, ±5
R009	0.009	±1, ±5	R020	0.020	±1, ±5	R040	0.040	±1, ±5
R010	0.010	±1, ±5	R022	0.022	±1, ±5	R043	0.043	±1, ±5
R011	0.011	±1, ±5	R024	0.024	±1, ±5	R047	0.047	±1, ±5
R012	0.012	±1, ±5	R027	0.027	±1, ±5	R050	0.050	±1, ±5

The specifications and designs contained herein may be subject to change without notice. Please contact our sales representatives or product engineers before order.

Operation Notes

Example of land Pattern Design

Recommended Soldering Conditions

General Structure

General

Low ohms (RUT Series)

Ultra Low ohms (RU Series)

Ultra Low Ohms (RUK Series)

Ultra Low Ohms (RJ Series)

Arrays (CONVEX Type)

Arrays (CONCAVE Type)

Arrays (FLAT Type)

Anti-Sulfur Resistors

Anti-Sulfur Resistor Arrays(Convex Type)

Anti-Sulfur Resistor Arrays(Concave Type)

Anti-Sulfur Resistor Arrays (Flat Type)

Automotive Anti-sulfur

Automotive Anti-sulfur Arrays (Convex Type)

Attenuator

Characteristics Performance

Packaging

Standard Resistance Value

Arrays(Convex Type)

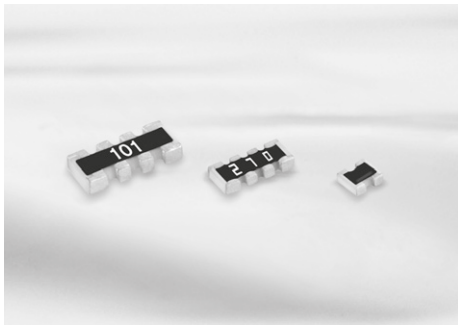

Feature

- Reducing SMD surface area (40% reduced).
- Reducing SMD costs (75% reduced).
- Both flow and reflow soldering are applicable.

The product of lead-free terminal is RoHS compliant. PbO(lead oxide) is included in the glass of our product which is prescribed on RoHS appendix as an exception.

Application

- For semiconductor devices.
- For computers, digital circuits.

Structure and Dimensions

• 2 Array

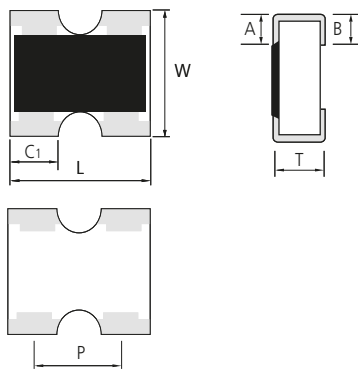

• 4 Array

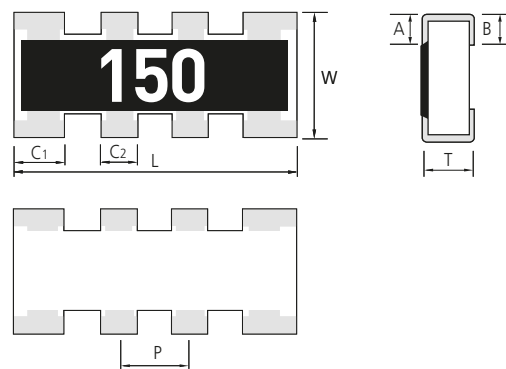

(UNIT: mm)

Type	L	W	T	A	B	C1	C2	P
RP102P	1.00±0.10	1.00±0.10	0.35±0.10	0.20±0.10	0.25±0.10	0.33±0.10	-	0.65±0.10
RP104P	2.00±0.10	1.00±0.10	0.35±0.10	0.20±0.10	0.25±0.10	0.40±0.10	0.30±0.10	0.50±0.10
RP164P	3.20±0.10	1.60±0.10	0.50±0.10	0.30±0.15	0.30±0.15	0.60±0.15	0.40±0.15	0.80±0.15

Parts Numbering System

- The part number system shall be in the following format

RP	10	4P	J	100	CS
Code Designation	Dimension	Resistors	Tolerance	Resistance Value	Packaging Code
RP: Convex	10 : 0402 Array 16 : 0603 Array	2P: 2 Pieces 4P: 4 Pieces	J : ±5% ※ Jumper : J	3 digits coding system (IEC coding system) E-24 series ※ Jumper : '000'	CS : Tape Packaging 7" ES : Tape Packaging 10" AS : Tape Packaging 13"

Specification

Type	Size (inch)	Rated Power (W)	Rated Voltage (V)	Max Working Voltage (V)	Tolerance (%)	Resistance Range (Ω)	T.C.R (ppm/°C)	Working Temp. (°C)	Rated Ambient Temp. (°C)	Moisture Level
RP102P	0404	1/16	$\sqrt{P \times R}$ P: Rated Power(W) R: Resistance(Ω)	25	±5(J)	1 ~ 9.9 10 ~ 1M	±300 ±200	-55~155	70	Level 1
RP104P	0804	1/16		25						
RP164P	1206	1/16		50						

• Please contact our sales representatives or engineers for other specifications

Power Derating Curve

The rated power is the maximum continuous loading power at 70°C ambient temperature.
For ambient temperature above 70°C, the loading power follows the below power derating curve.

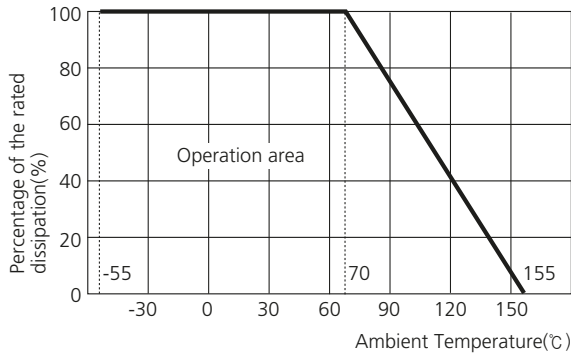

Land Pattern

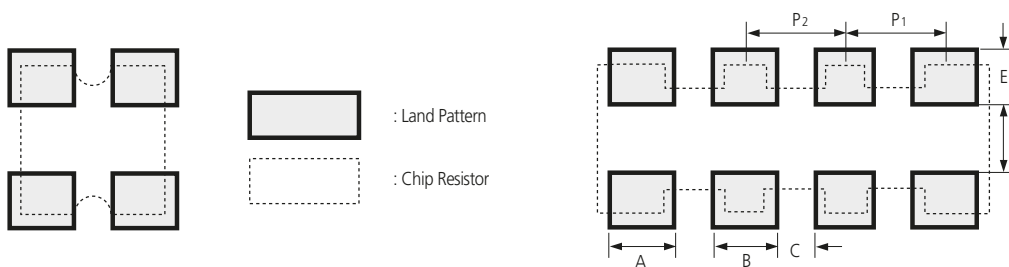

Type	A	B	C	D	E	P1	P2
RP10AT	0.4	-	0.25	0.5	0.5	0.65	-
RP102P	0.4	-	0.25	0.5	0.5	0.65	
RP104P	0.5	0.3	0.2	0.5	0.5	0.55	0.5
RP164P	0.7	0.5	0.3	0.9	0.8	0.9	0.8

The specifications and designs contained herein may be subject to change without notice.
Please contact our sales representatives or product engineers before order.

Operation Notes

Example of land Pattern Design

Recommended Soldering Conditions

General Structure

General

Low ohms (RUT Series)

Ultra Low ohms (RU Series)

Ultra Low Ohms (RUK Series)

Ultra Low Ohms (RJ Series)

Arrays (CONVEX Type)

Arrays (CONCAVE Type)

Arrays (FLAT Type)

Anti-Sulfur Resistors

Anti-Sulfur Resistor Arrays(Convex Type)

Anti-Sulfur Resistor Arrays(Concave Type)

Anti-Sulfur Resistor Arrays (Flat Type)

Automotive Anti-sulfur

Automotive Anti-sulfur Arrays (Convex Type)

Attenuator

Characteristics Performance

Packaging

Standard Resistance Value

Arrays (Concave Type)

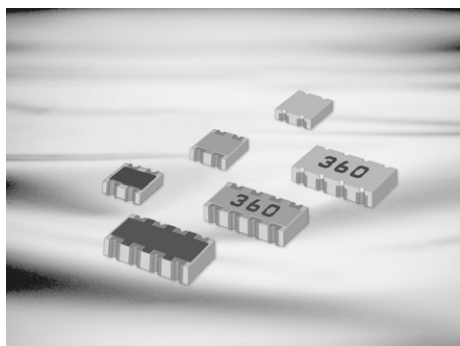

Feature

- Strong Body.
- Both flow and reflow soldering are applicable.
- Concave Type Terminal.

The product of lead-free terminal is RoHS compliant.
PbO (lead oxide) is included in the glass of our product which is prescribed on RoHS appendix as an exception.

Application

- For semiconductor devices.
- For computers, digital circuits.

Structure and Dimensions

(1) Concave Type

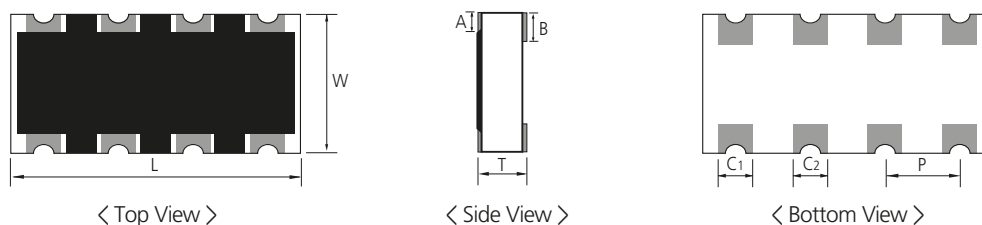

(UNIT: mm)

Type	L	W	T	A	B	C ₁	C ₂	P
RN102P	1.00±0.10	1.00±0.10	0.35±0.10	0.15±0.10	0.25±0.15	0.33±0.10	-	0.50±0.10
RN104P	2.00±0.10	1.00±0.10	0.40±0.10	0.15±0.10	0.25±0.15	0.30±0.10	0.30±0.10	0.50±0.10

(2) Inverted Concave Type

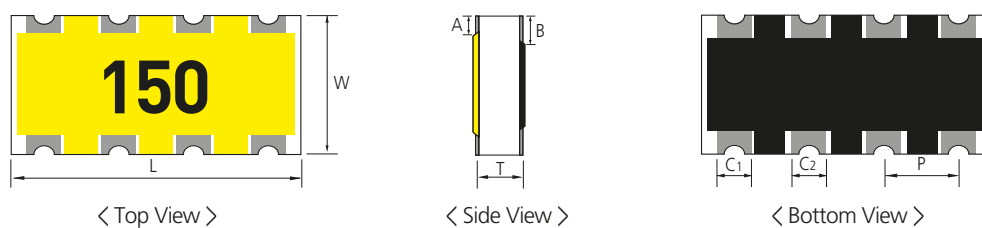

(UNIT: mm)

Type	L	W	T	A	B	C ₁	C ₂	P
RM102P	1.00±0.10	1.00±0.10	0.35±0.10	0.15±0.10	0.25±0.15	0.33±0.10	-	0.50±0.10
RM104P	2.00±0.10	1.00±0.10	0.45±0.10	0.15±0.10	0.25±0.15	0.30±0.10	0.30±0.10	0.50±0.10

(3) Short-free & Inverted Concave Type

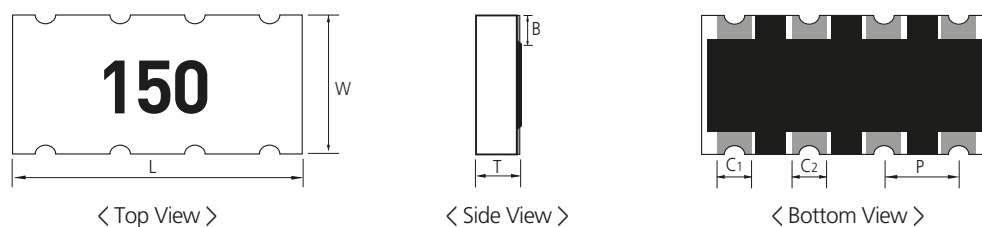

(UNIT: mm)

Type	L	W	T	A	B	C ₁	C ₂	P
RK102P	1.00±0.10	1.00±0.10	0.35±0.10	-	0.25±0.15	0.33±0.10	-	0.50±0.10
RK104P	2.00±0.10	1.00±0.10	0.45±0.10	-	0.25±0.15	0.30±0.10	0.30±0.10	0.50±0.10

Parts Numbering System

- The part number system shall be in the following format

RN	10	4P	J	100	CS
Code Designation	Dimension	Resistors	Tolerance	Resistance Value	Packaging Code
RN : Concave RM : Inverted Concave RK : Short-free & Inverted	10: 0402 Array	2P: 2 Pieces 4P: 4 Pieces	F: ±1% J: ±5% * Jumper : J	3 digit coding system (IEC coding system) E-24 series * Jumper : '000'	CS : Tape & Reel 7" ES : Tape & Reel 10" AS : Tape & Reel 13"

Specification

Type	Size (inch)	Rated Power (W)	Rated Voltage (V)	Max Working Voltage (V)	Tolerance (%)	Resistance Range (Ω)	T.C.R (ppm/°C)	Working Temp. (°C)	Rated Ambient Temp. (°C)	Moisture Level
102P	0404	1/16	$\sqrt{P \times R}$	25	±1(F) ±2(G) ±5(J)	1 ~ 9.9	±300	-55~155	70	Level 1
104P	0804	1/16	P: Rated Power(W) R: Resistance(Ω)	25		10 ~ 1M	±200			

- Please contact our sales representatives or engineers for other specifications

Power Derating Curve

The rated power is the maximum continuous loading power at 70°C ambient temperature. For ambient temperature above 70°C, the loading power follows the below power derating curve.

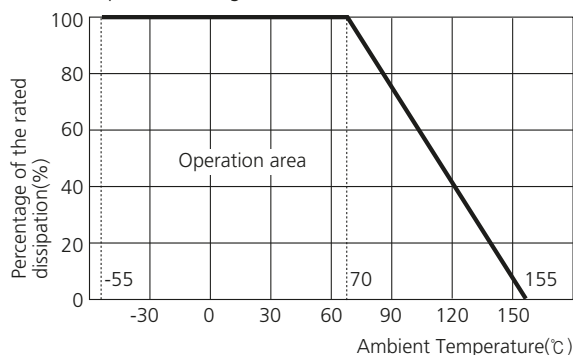

Jumper Rating

Type	Size (inch)	Rated Current (A)	Resistance (Ω)
102P	0404	1.0	0.05 Max
104P	0804		

Land Pattern

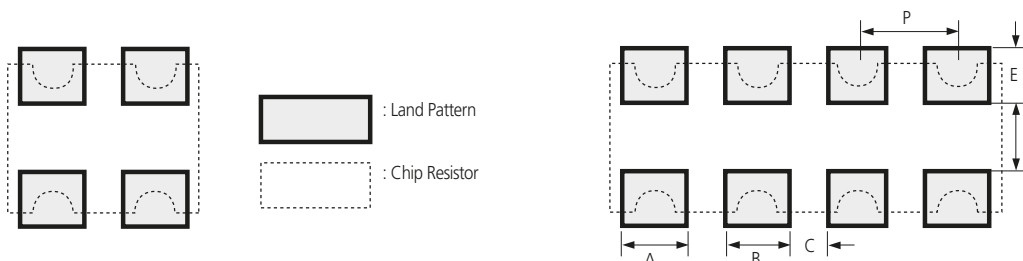

Type	A	B	C	D	E	P
102P	0.3	-	0.2	0.5	0.4	0.5
104P	0.3	0.3	0.2	0.5	0.4	0.5

The specifications and designs contained herein may be subject to change without notice. Please contact our sales representatives or product engineers before order.

Operation Notes

Example of land Pattern Design

Recommended Soldering Conditions

General Structure

General

Low ohms (RUT Series)

Ultra Low ohms (RU Series)

Ultra Low Ohms (RUK Series)

Ultra Low Ohms (RJ Series)

Arrays (CONVEX Type)

Arrays (CONCAVE Type)

Arrays (FLAT Type)

Anti-Sulfur Resistors

Anti-Sulfur Resistor Arrays(Convex Type)

Anti-Sulfur Resistor Arrays(Concave Type)

Anti-Sulfur Resistor Arrays (Flat Type)

Automotive Anti-sulfur

Automotive Anti-sulfur Arrays (Convex Type)

Attenuator

Characteristics Performance

Packaging

Standard Resistance Value

Arrays(Flat Type)

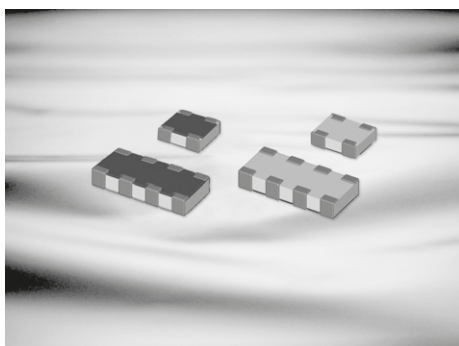

Feature

- Very Small Array.
- Stable and Accurate Resistance.
- Flat Type Terminal.

The product of lead-free terminal is RoHS compliant.
PbO(lead oxide) is included in the glass of our product which is prescribed on RoHS appendix as an exception.

Application

- For semiconductor devices.
- For computers, digital circuits.

Structure and Dimensions

(1) Flat Type Array

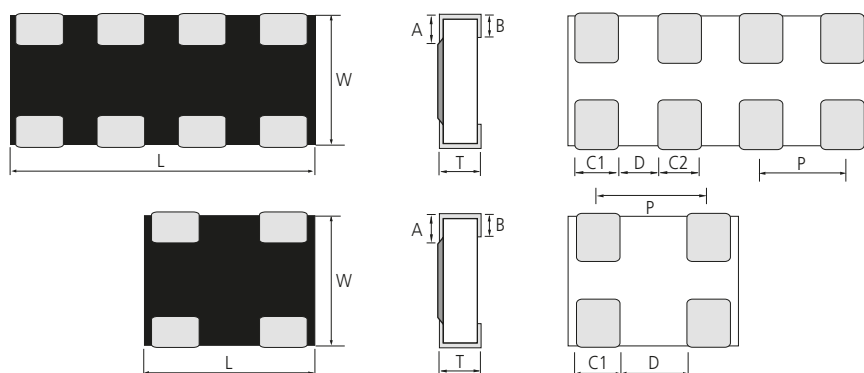

(UNIT: mm)

Type	L	W	T	A	B	C1	C2	P
RF062P	0.80±0.05	0.60±0.05	0.23±0.10	0.15±0.10	0.20±0.10	0.25±0.10	-	0.50±0.10
RF064P	1.40±0.05	0.60±0.05	0.23±0.10	0.15±0.10	0.20±0.10	0.25±0.10	0.25±0.10	0.40±0.10

(2) Inverted Type Array

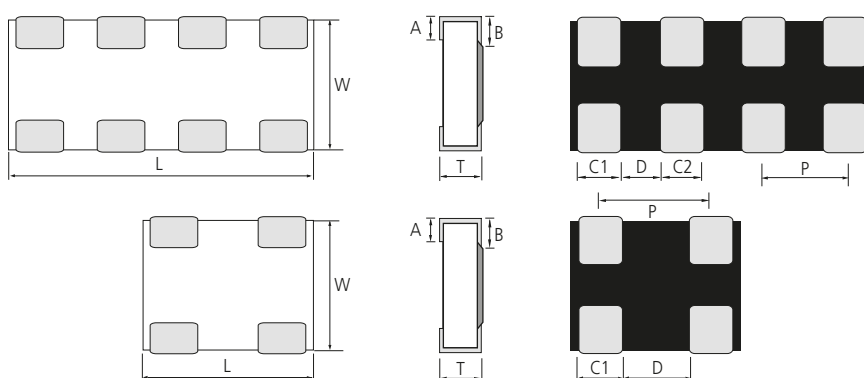

(UNIT: mm)

Type	L	W	T	A	B	C1	C2	P
RM062P	0.80±0.05	0.60±0.05	0.23±0.10	0.15±0.10	0.20±0.10	0.20±0.10	-	0.50±0.10
RM064P	1.40±0.05	0.60±0.05	0.23±0.10	0.15±0.10	0.20±0.10	0.20±0.10	0.20±0.10	0.40±0.10

Parts Numbering System

- The part number system shall be in the following format

RF	06	4P	J	150	CS
Code Designation	Dimension	Resistors	Tolerance	Resistance Value	Packaging Code
RF : Flat RM : Inverted & Flat	06: 0201 Array	2P: 2 Pieces 4P: 4 Pieces	J: ±5% ※ Jumper : J	3 digit coding system (IEC coding system) E-24 series ※ Jumper : '000'	CS : Tape & Reel 7" ES : Tape & Reel 10" AS : Tape & Reel 13"

Specification

Type	Size (inch)	Rated Power (W)	Rated Voltage (V)	Max Working Voltage (V)	Tolerance (%)	Resistance Range (Ω)	T.C.R (ppm/°C)	Working Temp. (°C)	Rated Ambient Temp. (°C)	Moisture Level
062P	0302	1/32	$\sqrt{P \times R}$ P: Rated Power(W) R: Resistance(Ω)	12.5	±5(J)	10 ~ 1M	±200	-55~125	70	Level 1
064P	0502	1/32		12.5						

- Please contact our sales representatives or engineers for other specifications

Power Derating Curve

The rated power is the maximum continuous loading power at 70°C ambient temperature.
For ambient temperature above 70°C, the loading power follows the below power derating curve.

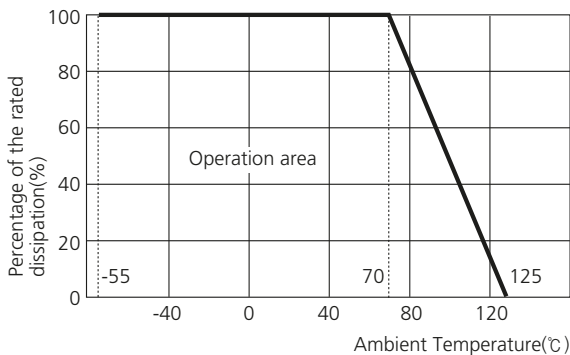

Jumper Rating

Type	Size (inch)	Rated Current (A)	Resistance (Ω)
062P	0302	0.5	0.05 Max
064P	0502		

Land Pattern

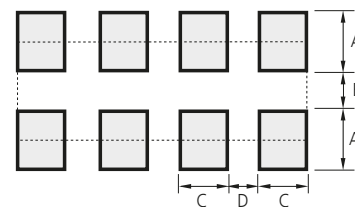
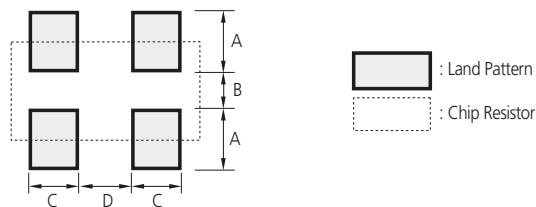

TYPE (Inch)	Reflow Soldering				
	A	B	2A + B	C	D
062P	0.3	0.3	0.9	0.2	0.3
064P	0.3	0.3	0.9	0.2	0.2

The specifications and designs contained herein may be subject to change without notice.
Please contact our sales representatives or product engineers before order.

Operation Notes

Example of land Pattern Design

Recommended Soldering Conditions

General Structure

General

Low ohms (RUT Series)

Ultra Low ohms (RU Series)

Ultra Low Ohms (RUK Series)

Ultra Low Ohms (RJ Series)

Arrays (CONVEX Type)

Arrays (CONCAVE Type)

Arrays (FLAT Type)

Anti-Sulfur Resistors

Anti-Sulfur Resistor Arrays(Convex Type)

Anti-Sulfur Resistor Arrays(Concave Type)

Anti-Sulfur Resistor Arrays (Flat Type)

Automotive Anti-sulfur

Automotive Anti-sulfur Arrays (Convex Type)

Attenuator

Characteristics Performance

Packaging

Standard Resistance Value

Anti-Sulfur Resistors

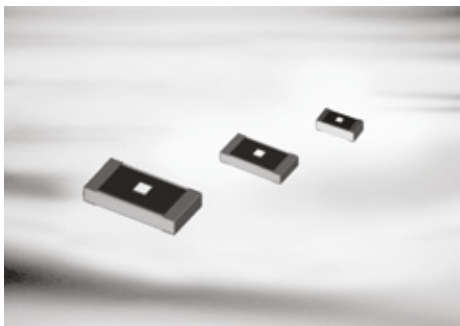

Feature

- Stable in the Sulfur Atmosphere.
- ASTM B809-95 Satisfied
- Passed 720hrs with the dried Sulfur at 105°C.
- High Precision Reliability.
- RoHS Compliant.

Application

- Electronic Devices with long-term reliability.
- Server System (Memory Module / HDD).
- Network Equipment.

Structure and Dimensions

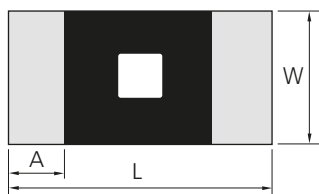

< Top View >



< Side View >

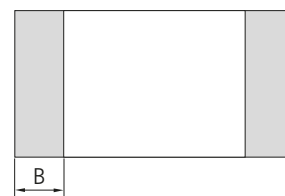

< Bottom View >

(UNIT: mm)

Type	SIZE(Inch)	L	W	T	A	B
RCS0603	0201	0.60±0.03	0.30±0.03	0.23±0.03	0.15±0.05	0.15±0.05
RCS1005	0402	1.00±0.05	0.50±0.05	0.35±0.05	0.20±0.10	0.25±0.10
RCS1608	0603	1.60±0.10	0.80±0.10	0.45±0.10	0.30±0.20	0.35±0.10
RCS2012	0805	2.00±0.20	1.25±0.15	0.55±0.10	0.40±0.20	0.35±0.20
RCS3216	1206	3.20±0.20	1.60±0.15	0.55±0.10	0.45±0.20	0.40±0.20
RCS3225	1210	3.20±0.20	2.55±0.20	0.55±0.10	0.45±0.20	0.40±0.20
RCS5025	2010	5.00±0.20	2.50±0.20	0.55±0.10	0.60±0.20	0.60±0.20
RCS6432	2512	6.30±0.20	3.20±0.20	0.55±0.10	0.60±0.20	0.60±0.20

Parts Numbering System

- The part number system shall be in the following format

RCS	2012	J	100	CS
Code Designation	Dimension & Size Code	Tolerance	Resistance Value	Packaging Code
RCS: Anti-sulfur General	0603: 0.6×0.3(mm) - 0201(inch) 1005: 1.0×0.5(mm) - 0402(inch) 1608: 1.6×0.8(mm) - 0603(inch) 2012: 2.0×1.2(mm) - 0805(inch) 3216: 3.2×1.6(mm) - 1206(inch) 3225: 3.2×2.5(mm) - 1210(inch) 5025: 5.0×2.5(mm) - 2010(inch) 6432: 6.4×3.2(mm) - 2512(inch)	D: ±0.5% F: ±1% G: ±2% J: ±5% ※ Jumper : J	3 or 4 digits coding system (IEC coding system) 3digits (E-24 series) 4digits (E-96 series) ※ Jumper : '000'	CS: Tape & Reel 7" ES: Tape & Reel 10" AS: Tape & Reel 13"

Specification

Type	Size (inch)	Rated Power (W)	Rated Voltage (V)	Max Working Voltage (V)	Tolerance (%)	Resistance Range (Ω)	T.C.R (ppm/°C)	Working Temp. (°C)	Rated Ambient Temp. (°C)	Moisture Level
RCS0603	0201	1/20	$\sqrt{P \times R}$ P: Rated Power(W) R: Resistance (Ω)	25	±1(F) ±2(G) ±5(J)	1 ~ 9.9 10 ~ 10M	±300 ±250	-55~125	70	Level 1
RCS1005	0402	1/16		50	±0.5(D) ±1(F) ±2(G) ±5(J)	1 ~ 9.9 10 ~ 10M	±300 ±100	-55~155		
RCS1608	0603	1/10		50						
RCS2012	0805	1/8		150						
RCS3216	1206	1/4		200						
RCS3225	1210	1/3		200						
RCS5025	2010	2/3		200						
RCS6432	2516	1		200						

• Please contact our sales representatives or engineers for other specifications

Power Derating Curve

The rated power is the maximum continuous loading power at 70°C ambient temperature.

For ambient temperature above 70°C, the loading power follows the below power derating curve.

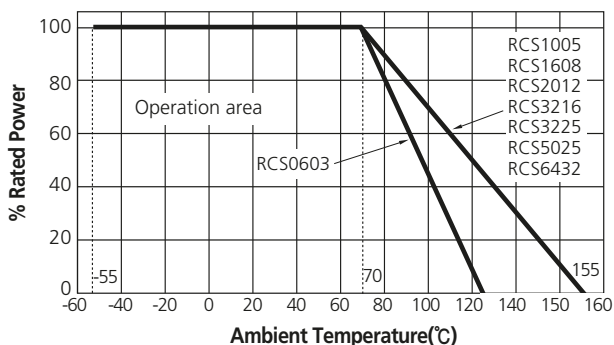

Jumper Rating

Type	Size (inch)	Rated Current (A)	Resistance (Ω)
RCS0603	0201	0.5	0.05 Max
RCS1005	0402	1.0	
RCS1608	0603		
RCS2012	0805		
RCS3216	1206	2.0	
RCS3225	1210		
RCS5025	2010		
RCS6432	2512		

Sulfur Corrosion Test

Test name	Adding Material	Temp.	Duration Time	Decision Criteria
ASTM B 809-95	Sulfur 50 g KNO ₃ 200 g DI water 200ml	50°C	720hrs	ΔR < ±1%
Dry Sulfur (IBM recommended)	Sulfur 50 g	105°C	720hrs	ΔR < ±1%

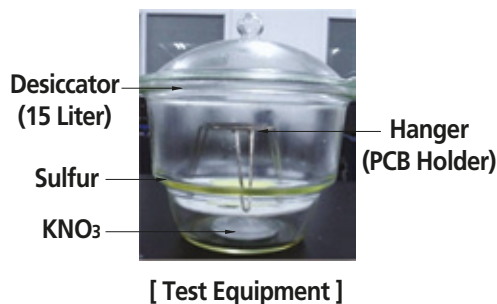

Operation Notes

Example of land Pattern Design

Recommended Soldering Conditions

General Structure

General

Low ohms (RUT Series)

Ultra Low ohms (RU Series)

Ultra Low Ohms (RUK Series)

Ultra Low Ohms (RJ Series)

Arrays (CONVEX Type)

Arrays (CONCAVE Type)

Arrays (FLAT Type)

Anti-Sulfur Resistors

Anti-Sulfur Resistor Arrays (Convex Type)

Anti-Sulfur Resistor Arrays (Concave Type)

Anti-Sulfur Resistor Arrays (Flat Type)

Automotive Anti-sulfur

Automotive Anti-sulfur Arrays (Convex Type)

Attenuator

Characteristics Performance

Packaging

Standard Resistance Value

Anti-Sulfur Resistor Arrays (Convex Type)

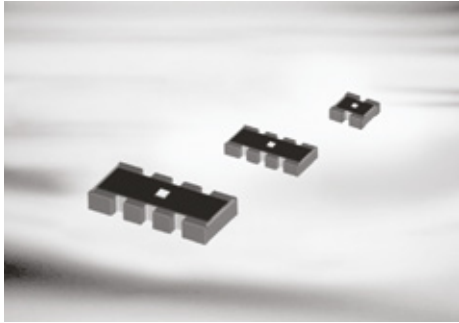

Feature

- Stable in the Sulfur Atmosphere.
- ASTM Satisfied
- Passed 720hrs with the dried Sulfur at 105°C.
- High Precision Reliability.
- RoHS Compliant.

Application

- Electronic Devices with long-term reliability.
- Server System (Memory Module / HDD).
- Network Equipment.
- Automotive ECU parts

Structure and Dimensions

• 2 Array

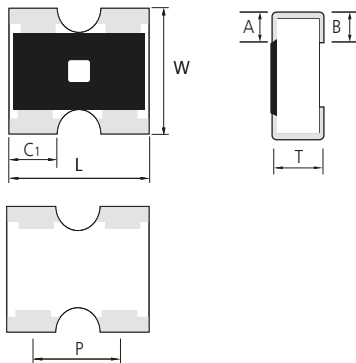

• 4 Array

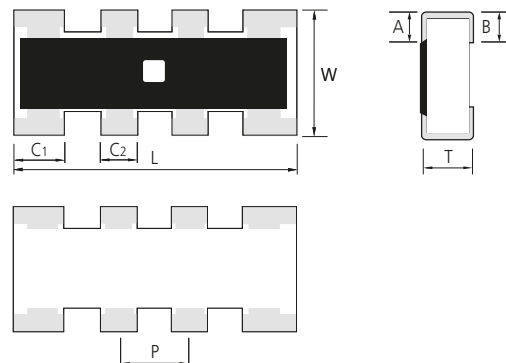

(UNIT: mm)

Type	L	W	T	A	B	C1	C2	P
RPS102P	1.00±0.10	1.00±0.10	0.35±0.10	0.20±0.10	0.25±0.10	0.33±0.10	-	0.65±0.10
RPS104P	2.00±0.10	1.00±0.10	0.35±0.10	0.20±0.10	0.25±0.10	0.40±0.10	0.30±0.10	0.50±0.10
RPS164P	3.20±0.10	1.60±0.10	0.50±0.10	0.30±0.15	0.30±0.15	0.60±0.15	0.40±0.15	0.80±0.15

Parts Numbering System

• The part number system shall be in the following format

RPS	10	4P	J	100	CS
Code Designation	Dimension	Resistors	Tolerance	Resistance Value	Packaging Code
RPS : Anti-Sulfur Convex	10 : 0402 Array 16 : 0603 Array	2P : 2 Pieces 4P : 4 Pieces	F : ±1% G : ±2% J : ±5% ※ Jumper : J	3 or 4 digits coding system (IEC coding system) 3digits (E-24 series) 4digits (E-96 series) ※ Jumper : '000'	CS : Tape Packaging 7" ES : Tape Packaging 10" AS : Tape Packaging 13"

Specification

Type	Size (inch)	Rated Power (W)	Rated Voltage (V)	Max Working Voltage (V)	Tolerance (%)	Resistance Range (Ω)	T.C.R (ppm/°C)	Working Temp. (°C)	Rated Ambient Temp. (°C)	Moisture Level
RPS 102P	0404	1/16	$\sqrt{P \times R}$ P: Rated Power(W) R: Resistance(Ω)	25	±5(J)	1 ~ 9.9 10 ~ 1M	±300 ±200	-55~155	70	Level 1
RPS 104P	0804	1/16		25						
RPS 164P	1206	1/16		50						

• Please contact our sales representatives or engineers for other specifications

Power Derating Curve

The rated power is the maximum continuous loading power at 70°C ambient temperature.
For ambient temperature above 70°C, the loading power follows the below power derating curve.

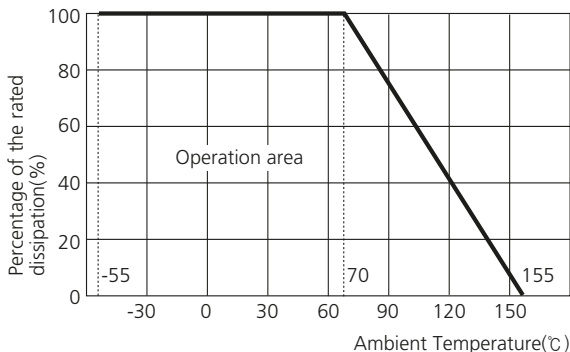

Jumper Rating

Type	Size (inch)	Rated Current (A)	Resistance (Ω)
RPS102P	0404	1.0	0.05 Max
RPS104P	0804		
RPS164P	1206		

Land Pattern

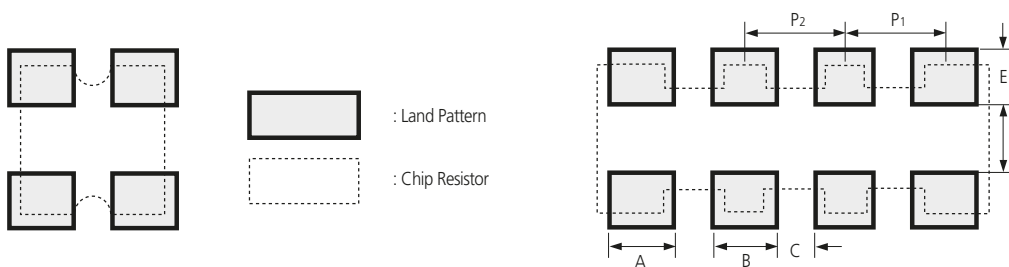

Type	A	B	C	D	E	P1	P2
RPS102P	0.4	-	0.25	0.5	0.5	0.65	-
RPS104P	0.5	0.3	0.2	0.5	0.5	0.55	0.5
RPS164P	0.7	0.5	0.3	0.9	0.8	0.9	0.8

The specifications and designs contained herein may be subject to change without notice.
Please contact our sales representatives or product engineers before order.

Operation Notes

Example of land Pattern Design

Recommended Soldering Conditions

General Structure

General

Low ohms (RUT Series)

Ultra Low ohms (RU Series)

Ultra Low Ohms (RUK Series)

Ultra Low Ohms (RJ Series)

Arrays (CONVEX Type)

Arrays (CONCAVE Type)

Arrays (FLAT Type)

Anti-Sulfur Resistors

Anti-Sulfur Resistor Arrays(Convex Type)

Anti-Sulfur Resistor Arrays(Concave Type)

Anti-Sulfur Resistor Arrays (Flat Type)

Automotive Anti-sulfur

Automotive Anti-sulfur Arrays (Convex Type)

Attenuator

Characteristics Performance

Packaging

Standard Resistance Value

Anti-Sulfur Resistor Arrays (Concave Type)



Feature

- Stable in the Sulfur Atmosphere.
- ASTM Satisfied
- Passed 720hrs with the dried Sulfur at 105°C.
- High Precision Reliability.
- RoHS Compliant.

Application

- Electronic Devices with long-term reliability.
- Server System (Memory Module / HDD).
- Network Equipment.
- Automotive ECU parts

Structure and Dimensions

(1) Concave Type

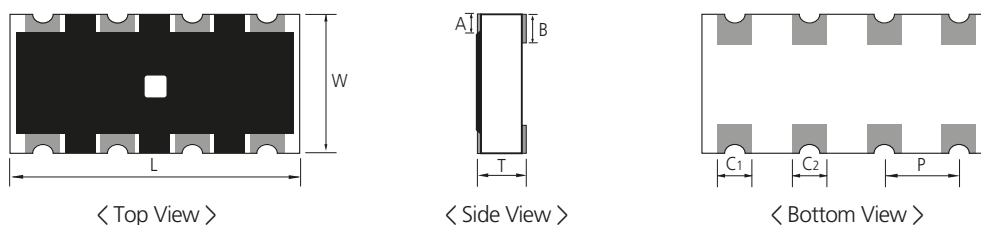

(UNIT: mm)

Type	L	W	T	A	B	C ₁	C ₂	P
RNS102P	1.00±0.10	1.00±0.10	0.35±0.10	0.15±0.10	0.25±0.15	0.33±0.10	-	0.50±0.10
RNS104P	2.00±0.10	1.00±0.10	0.40±0.10	0.15±0.10	0.25±0.15	0.30±0.10	0.30±0.10	0.50±0.10

(2) Inverted Concave Type

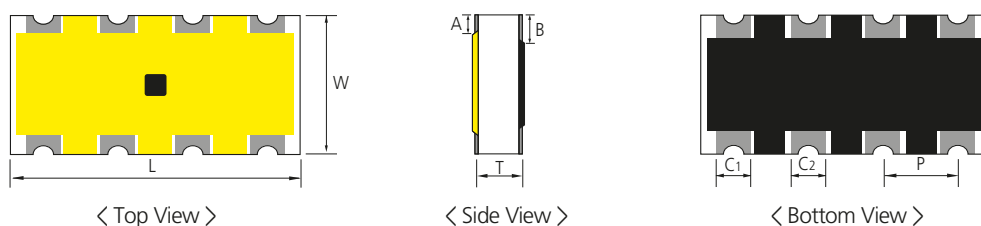

(UNIT: mm)

Type	L	W	T	A	B	C ₁	C ₂	P
RMS102P	1.00±0.10	1.00±0.10	0.35±0.10	0.15±0.10	0.25±0.15	0.33±0.10	-	0.50±0.10
RMS104P	2.00±0.10	1.00±0.10	0.45±0.10	0.15±0.10	0.25±0.15	0.30±0.10	0.30±0.10	0.50±0.10

(3) Short-free & Inverted Concave Type

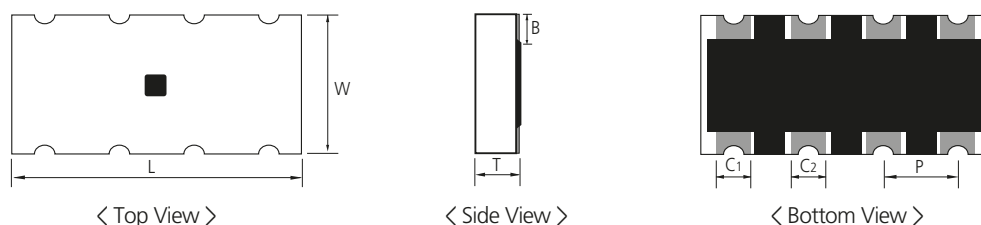

(UNIT: mm)

Type	L	W	T	A	B	C ₁	C ₂	P
RKS102P	1.00±0.10	1.00±0.10	0.35±0.10	-	0.25±0.15	0.33±0.10	-	0.50±0.10
RKS104P	2.00±0.10	1.00±0.10	0.45±0.10	-	0.25±0.15	0.30±0.10	0.30±0.10	0.50±0.10

Parts Numbering System

- The part number system shall be in the following format

RMS Code Designation	10 Dimension	4P Resistors	J Tolerance	100 Resistance Value	CS Packaging Code
RNS : Anti-Sulfur Concave RMS : Anti-Sulfur Inverted Concave RKS : Anti-Sulfur Short-free & Inverted	10: 0402 Array	2P: 2 Pieces 4P: 4 Pieces	F: ±1% J: ±5% ※ Jumper : J	3 digit coding system (IEC coding system) E-24 series ※ Jumper : '000'	CS : Tape & Reel 7" ES : Tape & Reel 10" AS : Tape & Reel 13"

Specification

Type	Size (inch)	Rated Power (W)	Rated Voltage (V)	Max Working Voltage (V)	Tolerance (%)	Resistance Range (Ω)	T.C.R (ppm/°C)	Working Temp. (°C)	Rated Ambient Temp. (°C)	Moisture Level
102P	0404	1/16	$\sqrt{P \times R}$ P: Rated Power(W) R: Resistance(Ω)	25	±1(F) ±2(G) ±5(J)	1 ~ 9.9	±300	-55~155	70	Level 1
104P	0804	1/16		25	10 ~ 1M	±200				

- Please contact our sales representatives or engineers for other specifications

Power Derating Curve

The rated power is the maximum continuous loading power at 70°C ambient temperature.
For ambient temperature above 70°C, the loading power follows the below power derating curve.

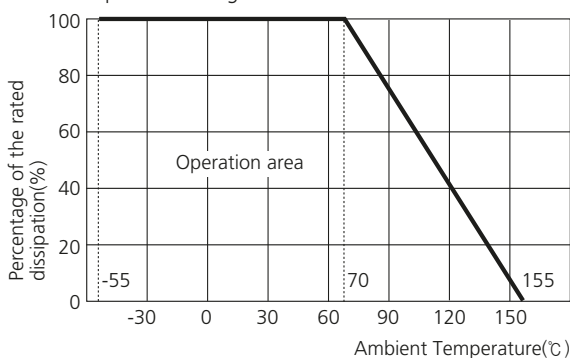

Jumper Rating

Type	Size (inch)	Rated Current (A)	Resistance (Ω)
102P	0404	1.0	0.05 Max
104P	0804		

Land Pattern

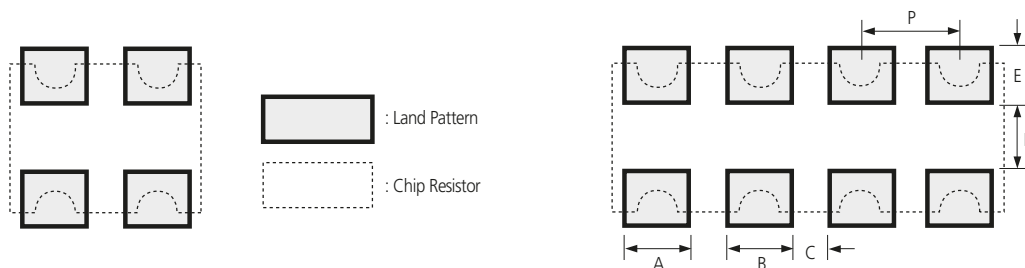

Type	A	B	C	D	E	P
102P	0.3	-	0.2	0.5	0.4	0.5
104P	0.3	0.3	0.2	0.5	0.4	0.5

The specifications and designs contained herein may be subject to change without notice.
Please contact our sales representatives or product engineers before order.

Operation Notes

Example of land Pattern Design

Recommended Soldering Conditions

General Structure

General

Low ohms (RUT Series)

Ultra Low ohms (RU Series)

Ultra Low Ohms (RUK Series)

Ultra Low Ohms (RJ Series)

Arrays (CONVEX Type)

Arrays (CONCAVE Type)

Arrays (FLAT Type)

Anti-Sulfur Resistors

Anti-Sulfur Resistor Arrays (Convex Type)

Anti-Sulfur Resistor Arrays (Concave Type)

Anti-Sulfur Resistor Arrays (Flat Type)

Automotive Anti-sulfur

Automotive Anti-sulfur Arrays (Convex Type)

Attenuator

Characteristics Performance

Packaging

Standard Resistance Value

Anti-Sulfur Resistor Arrays (Flat Type)

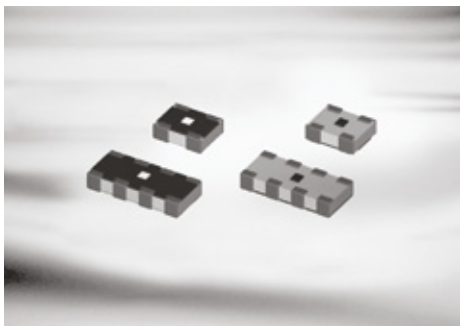

Feature

- Stable in the Sulfur Atmosphere.
- ASTM Satisfied
- Passed 720hrs with the dried Sulfur at 105°C.
- High Precision Reliability.
- RoHS Compliant.

Application

- Electronic Devices with long-term reliability.
- Server System (Memory Module / HDD).
- Network Equipment.
- Automotive ECU parts

Structure and Dimensions

(1) Flat Type Array

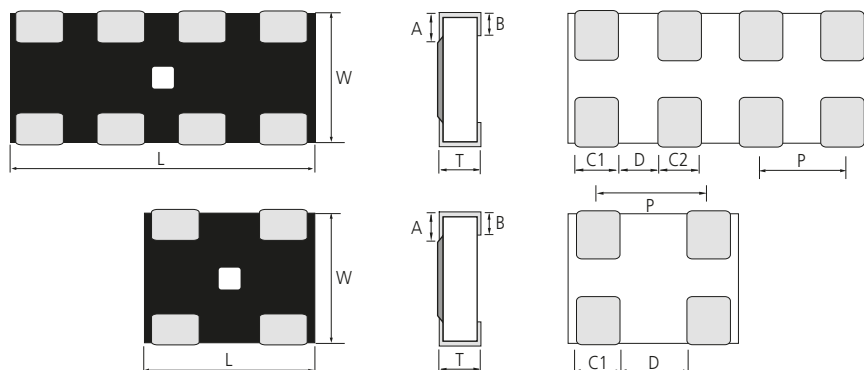

(UNIT: mm)

Type	L	W	T	A	B	C1	C2	P
RFS062P	0.80±0.05	0.60±0.05	0.23±0.10	0.15±0.10	0.20±0.10	0.25±0.10	-	0.50±0.10
RFS064P	1.40±0.05	0.60±0.05	0.23±0.10	0.15±0.10	0.20±0.10	0.25±0.10	0.25±0.10	0.40±0.10

(2) Inverted Type Array

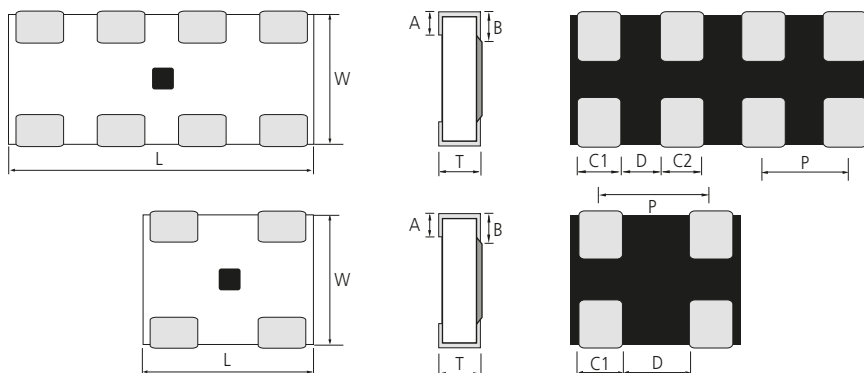

(UNIT: mm)

Type	L	W	T	A	B	C1	C2	P
RMS062P	0.80±0.05	0.60±0.05	0.23±0.10	0.15±0.10	0.20±0.10	0.20±0.10	-	0.50±0.10
RMS064P	1.40±0.05	0.60±0.05	0.23±0.10	0.15±0.10	0.20±0.10	0.20±0.10	0.20±0.10	0.40±0.10

Parts Numbering System

- The part number system shall be in the following format

RFS	06	4P	J	150	CS
Code Designation	Dimension	Resistors	Tolerance	Resistance Value	Packaging Code
RFS : Anti-Sulfur Flat RMS : Anti-Sulfur Inverted & Flat	06 : 0201 Array	2P: 2 Pieces 4P: 4 Pieces	J: ±5% ※ Jumper : J	3 digit coding system (IEC coding system) E-24 series ※ Jumper : '000'	CS : Tape & Reel 7" ES : Tape & Reel 10" AS : Tape & Reel 13"

Specification

Type	Size (inch)	Rated Power (W)	Rated Voltage (V)	Max Working Voltage (V)	Tolerance (%)	Resistance Range (Ω)	T.C.R (ppm/°C)	Working Temp. (°C)	Rated Ambient Temp. (°C)	Moisture Level
062P	0302	1/32	$\sqrt{P \times R}$ P: Rated Power(W) R: Resistance(Ω)	12.5	±5(J)	10 ~ 1M	±200	-55~125	70	Level 1
064P	0502	1/32		12.5						

- Please contact our sales representatives or engineers for other specifications

Power Derating Curve

The rated power is the maximum continuous loading power at 70°C ambient temperature.
For ambient temperature above 70°C, the loading power follows the below power derating curve.

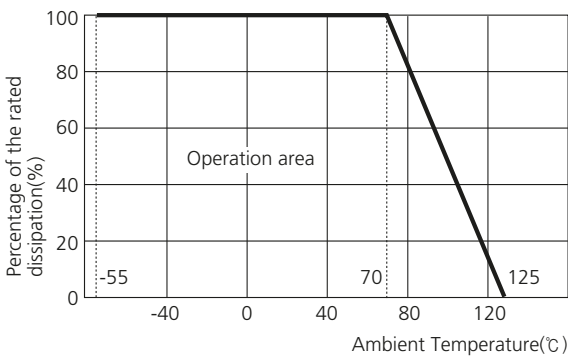

Jumper Rating

Type	Size (inch)	Rated Current (A)	Resistance (Ω)
062P	0302	0.5	0.05 Max
064P	0502		

Land Pattern

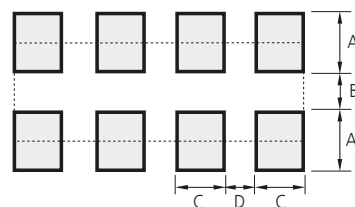
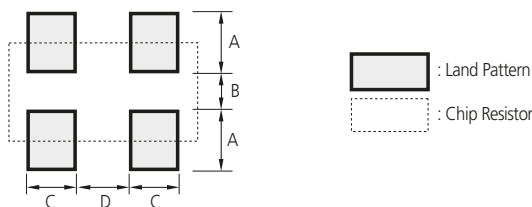

TYPE (Inch)	Reflow Soldering				
	A	B	2A + B	C	D
062P	0.3	0.3	0.9	0.2	0.3
064P	0.3	0.3	0.9	0.2	0.2

The specifications and designs contained herein may be subject to change without notice.
Please contact our sales representatives or product engineers before order.

Operation Notes

Example of land Pattern Design

Recommended Soldering Conditions

General Structure

General

Low ohms (RUT Series)

Ultra Low ohms (RU Series)

Ultra Low Ohms (RUK Series)

Ultra Low Ohms (RJ Series)

Arrays (CONVEX Type)

Arrays (CONCAVE Type)

Arrays (FLAT Type)

Anti-Sulfur Resistors

Anti-Sulfur Resistor Arrays(Convex Type)

Anti-Sulfur Resistor Arrays(Concave Type)

Anti-Sulfur Resistor Arrays (Flat Type)

Automotive Anti-sulfur

Automotive Anti-sulfur Arrays (Convex Type)

Attenuator

Characteristics Performance

Packaging

Standard Resistance Value

Automotive Anti-sulfur

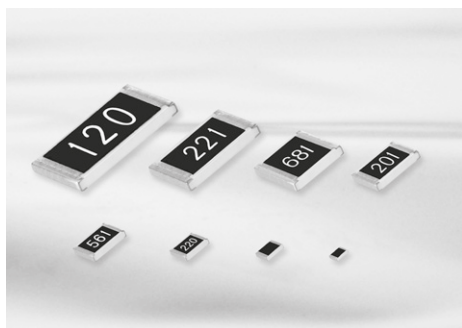

Feature

- AEC-Q200 Qualified.
- ASTM B809-95 satisfied.
- Excellent anti-sulfur performance.
- Lead-free terminal (matt tin)
- RoHS compliant with exemption.

Application

- Electronic Control Units of Automotive Parts
- Automotive grade applications
- Infotainment applications for car.

Structure and Dimensions

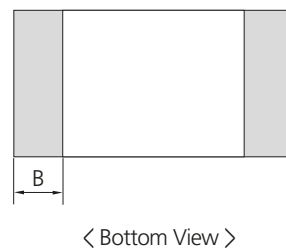
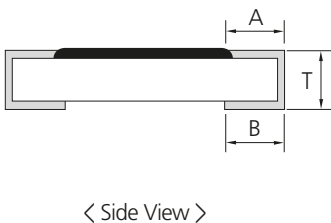
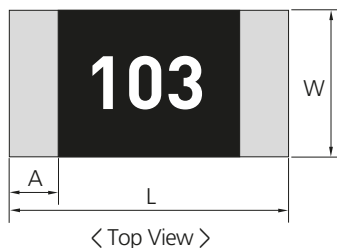

(UNIT: mm)

Type	SIZE(Inch)	L	W	T	A	B
RCM0603	0201	0.60 ±0.03	0.30 ±0.03	0.23 ±0.03	0.10 ±0.05	0.15 ±0.05
RCM1005	0402	1.00 ±0.05	0.50 ±0.05	0.35 ±0.05	0.20 ±0.10	0.25 ±0.10
RCM1608	0603	1.60 ±0.10	0.80 ±0.10	0.45 ±0.10	0.30 ±0.20	0.35 ±0.10
RCM2012	0805	2.00 ±0.20	1.25 ±0.15	0.55 ±0.10	0.40 ±0.20	0.35 ±0.20
RCM3216	1206	3.20 ±0.20	1.60 ±0.15	0.55 ±0.10	0.45 ±0.20	0.40 ±0.20
RCM3225	1210	3.20 ±0.20	2.55 ±0.20	0.55 ±0.10	0.45 ±0.20	0.40 ±0.20
RCM5025	2010	5.00 ±0.20	2.50 ±0.20	0.55 ±0.10	0.60 ±0.20	0.60 ±0.20
RCM6432	2512	6.30 ±0.20	3.20 ±0.20	0.55 ±0.10	0.60 ±0.20	0.60 ±0.20

- ※ 0402 and smaller size don't have marking on top of the chips.
- ※ 0603 4-digit models(E-96 series) don't have marking on top of the chips.

Parts Numbering System

- The part number system shall be in the following format

RCM	2 0 1 2 Dimension & Size Code	J Tolerance	1 0 0 Resistance Value	CS Packaging Code
RCM : Automotive	0603: 0.6×0.3(mm) - 0201(inch) 1005: 1.0×0.5(mm) - 0402(inch) 1608: 1.6×0.8(mm) - 0603(inch) 2012: 2.0×1.2(mm) - 0805(inch) 3216: 3.2×1.6(mm) - 1206(inch) 3225: 3.2×2.5(mm) - 1210(inch) 5025: 5.0×2.5(mm) - 2010(inch) 6432: 6.4×3.2(mm) - 2512(inch)	F : ±1% G : ±2% J : ±5% ※ Jumper : J	3 or 4 digits coding system (IEC coding system) 3digits (E-24 series) 4digits (E-96 series) ※ Jumper : '000'	CS: Tape Packaging 7" ES: Tape Packaging 10" AS: Tape Packaging 13"

Specification

Type	Size (inch)	Rated Power (W)	Rated Voltage (V)	Max Working Voltage (V)	Tolerance (%)	Resistance Range (Ω)	T.C.R (ppm/°C)	Working Temp. (°C)	Rated Ambient Temp. (°C)	Moisture Level
RCM0603	0201	1/20	$\sqrt{P \times R}$ P: Rated Power(W) R: Resistance(Ω)	25	±1(F) ±2(G) ±5(J)	1 ~ 9.9 10 ~ 10M	±300 ±250	-55~125	70	Level 1
RCM1005	0402	1/16		50	±0.5(D) ±1(F) ±2(G) ±5(J)	1 ~ 99 100 ~ 1M	±300 ±100	-55~155		
RCM1608	0603	1/10		50						
RCM2012	0805	1/8		150						
RCM3216	1206	1/4		200						
RCM3225	1210	1/3		200						
RCM5025	2010	2/3		200						
RCM6432	2512	1		200						

• Please contact our sales representatives or engineers for other specifications

Power Derating Curve

The rated power is the maximum continuous loading power at 70°C ambient temperature.
For ambient temperature above 70°C, the loading power follows the below power derating curve.

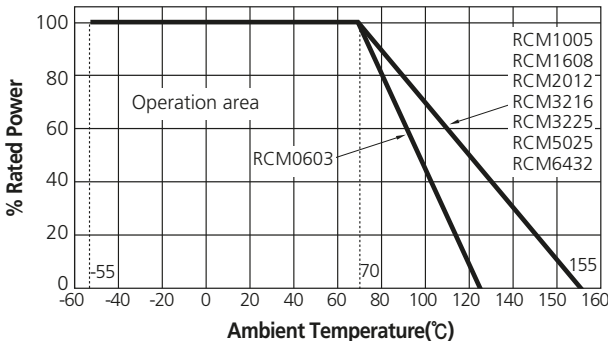

Marking

• 3 digits indication (E-24 series)	• 4 digits indication (E-96 series)
<ul style="list-style-type: none"> - Left 2 digits represent significant figures. - Last 1 digit represents exponential number of 10. - Example: 103 Left 2 digits: 10 Last 1 digit: 3 $103 = 10 \times 10^3 \Omega = 10000 \Omega = 10k\Omega$ 	<ul style="list-style-type: none"> - Left 3 digits represent significant figures. - Last 1 digit represents exponential number of 10. - Example: 1002 Left 3 digits: 100 Last 1 digit: 2 $1002 = 100 \times 10^2 \Omega = 10000 \Omega = 10k\Omega$
No marking types for 3 -digit models : RC0402, RC0603, RC1005	No marking types for 4 -digit models : RC0402, RC0603, RC1005, RC1608

Jumper Rating

Type	Size (inch)	Rated Current (A)	Resistance (Ω)
RCM0603	0201	0.5	0.05 Max
RCM1005	0402	1.0	
RCM1608	0603	2.0	
RCM2012	0805	2.0	
RCM3216	1206	2.0	
RCM3225	1210	2.0	
RCM5025	2010	2.0	
RCM6432	2512	2.0	

IEC Code System (E-96, E-24)

E-96	E-24	E-96	E-24	E-96	E-24	E-96	E-24
100	10	178		316		562	56
102		182	18	324	33	576	
105		187		332		590	
107		191		340		604	
110	11	196		348		619	
113		200	20	357	36	634	62
115		205		365		649	
118		210		374		665	
121	12	215		383	39	681	68
124		221	22	392		698	
127		226		402		715	
130	13	232		412		732	
133		237		422		750	75
137		243	24	432	43	768	
140		249		442		787	
143		255		453		806	
147		261		464		825	82
150	15	267		475	47	845	
154		274	27	487		866	
158		280		499		887	
162	16	287		511	51	909	
165		294		523		931	91
169		301	30	536		953	
174		309		549		976	

The specifications and designs contained herein may be subject to change without notice.
Please contact our sales representatives or product engineers before order.

Operation Notes

Example of land Pattern Design

Recommended Soldering Conditions

General Structure

General

Low ohms (RUT Series)

Ultra Low ohms (RU Series)

Ultra Low Ohms (RUK Series)

Ultra Low Ohms (RJ Series)

Arrays (CONVEX Type)

Arrays (CONCAVE Type)

Arrays (FLAT Type)

Anti-Sulfur Resistors

Anti-Sulfur Resistor Arrays(Convex Type)

Anti-Sulfur Resistor Arrays(Concave Type)

Anti-Sulfur Resistor Arrays (Flat Type)

Automotive Anti-sulfur

Automotive Anti-sulfur Arrays (Convex Type)

Attenuator

Characteristics Performance

Packaging

Standard Resistance Value

Automotive Anti-sulfur Arrays (Convex Type)

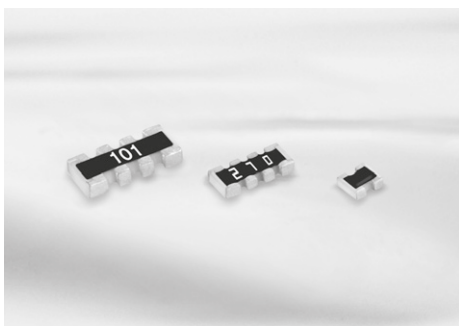

Feature

- AEC-Q200 Qualified.
- ASTM B809-95 satisfied.
- Excellent anti-sulfur performance.
- Lead-free terminal (matt tin)
- RoHS complaint with exemption.

Application

- Electronic Control Units of Automotive Parts
- Automotive grade applications
- Infotainment applications for car.

Structure and Dimensions

• 2 Array

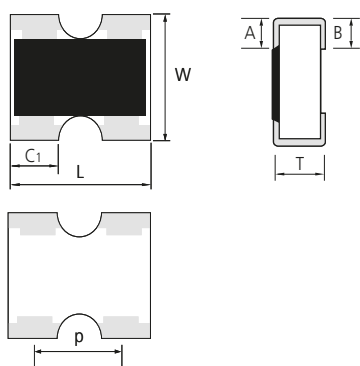

• 4 Array

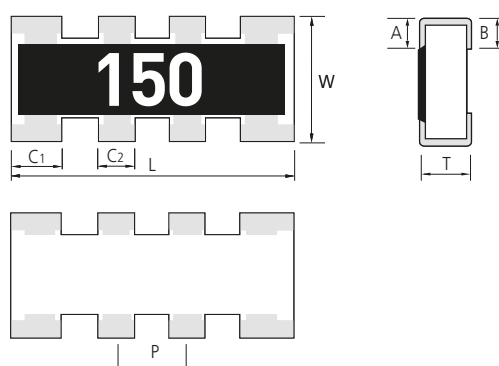

(UNIT: mm)

Type	L	W	T	A	B	C1	C2	P
RPM102P	1.00±0.10	1.00±0.10	0.35±0.10	0.20±0.10	0.25±0.10	0.33±0.10	-	0.65±0.10
RPM104P	2.00±0.10	1.00±0.10	0.35±0.10	0.20±0.10	0.25±0.10	0.40±0.10	0.30±0.10	0.50±0.10
RPM164P	3.20±0.10	1.60±0.10	0.50±0.10	0.30±0.15	0.30±0.15	0.60±0.15	0.40±0.15	0.80±0.15

Parts Numbering System

• The part number system shall be in the following format

RPM	10	4P	J	100	CS
Code Designation	Dimension	Resistors	Tolerance	Resistance Value	Packaging Code
RPM : Automotive Convex	10 : 1005 Array 16 : 1608 Array	2P: 2 Pieces 4P: 4 Pieces	F: ±1% G: ±2% J: ±5% ※ Jumper : J	3 or 4 digits coding system (IEC coding system) 3digits (E-24 series) 4digits (E-96 series) ※ Jumper : '000'	CS : Tape Packaging 7" ES : Tape Packaging 10" AS : Tape Packaging 13"

Specification

Type	Size (inch)	Rated Power (W)	Rated Voltage (V)	Max Working Voltage (V)	Tolerance (%)	Resistance Range (Ω)	T.C.R (ppm/°C)	Working Temp. (°C)	Rated Ambient Temp. (°C)	Moisture Level
RPM102P	0404	1/16	$\sqrt{P \times R}$ P: Rated Power(W) R: Resistance(Ω)	25	±1(F)	1 ~ 9.9 10 ~ 1M	±300 ±200	-55~155	70	Level 1
RPM104P	0804	1/16		25	±2(G)					
RPM164P	1206	1/16		50	±5(J)					

• Please contact our sales representatives or engineers for other specifications

Power Derating Curve

The rated power is the maximum continuous loading power at 70°C ambient temperature.
For ambient temperature above 70°C, the loading power follows the below power derating curve.

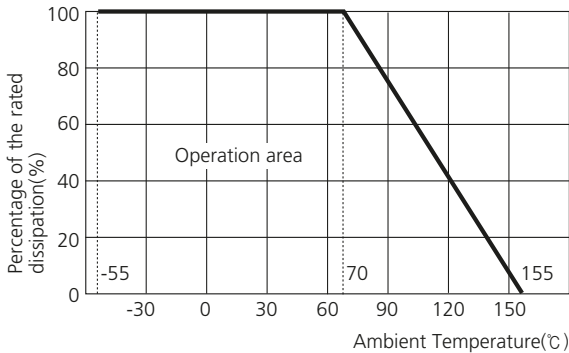

Jumper Rating

Type	Size (inch)	Rated Current (A)	Resistance (Ω)
RPM102P	0404	1.0	0.05 Max
RPM104P	0804		
RPM164P	1206		

Land Pattern

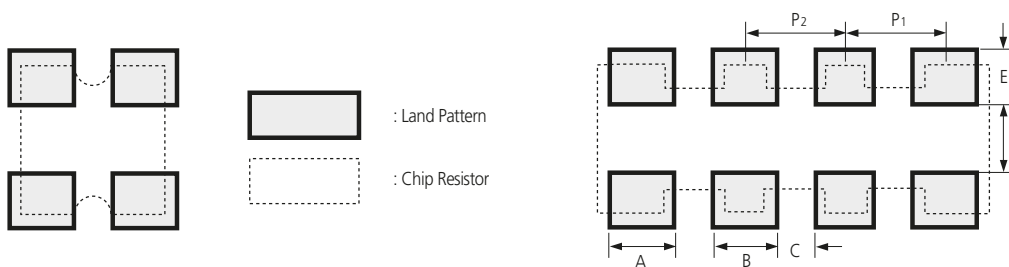

Type	A	B	C	D	E	P1	P2
RPM102P	0.4	-	0.25	0.5	0.5	0.65	-
RPM104P	0.7	0.3	0.2	0.5	0.5	0.55	0.5
RPM164P	0.7	0.5	0.3	0.9	0.8	0.9	0.8

The specifications and designs contained herein may be subject to change without notice.
Please contact our sales representatives or product engineers before order.

Operation Notes

Example of land Pattern Design

Recommended Soldering Conditions

General Structure

General

Low ohms (RUT Series)

Ultra Low ohms (RU Series)

Ultra Low Ohms (RUK Series)

Ultra Low Ohms (RJ Series)

Arrays (CONVEX Type)

Arrays (CONCAVE Type)

Arrays (FLAT Type)

Anti-Sulfur Resistors

Anti-Sulfur Resistor Arrays(Convex Type)

Anti-Sulfur Resistor Arrays(Concave Type)

Anti-Sulfur Resistor Arrays (Flat Type)

Automotive Anti-sulfur

Automotive Anti-sulfur Arrays (Convex Type)

Attenuator

Characteristics Performance

Packaging

Standard Resistance Value

Attenuator

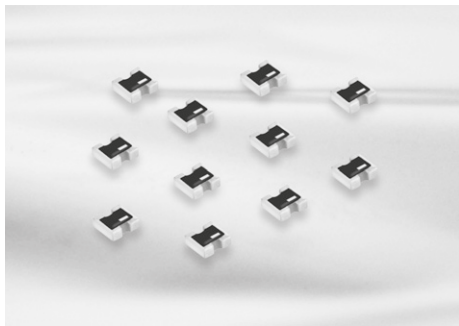

Feature

- The RP10AT is small-size chip Attenuator, suitable for high density surface mounting.
- Unbalanced π type attenuator circuit in one chip(1.0 mm x 1.0 mm).
- Mounting occupation area reduction : about 50 % reduction.
- Mounting cost reduction : Mounting times 3 times \rightarrow 1 time.
- Attenuation : 0 dB to 10 dB.

Application

- Attenuation / level control / impedance matching of high frequency signals of communication equipment; cellular phones(GSM, CDMA, etc.), PHS, PDA, for example.

Structure and Dimensions

• Structure

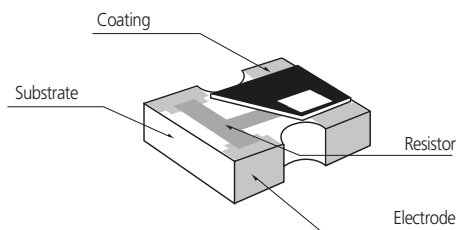

• Dimensions

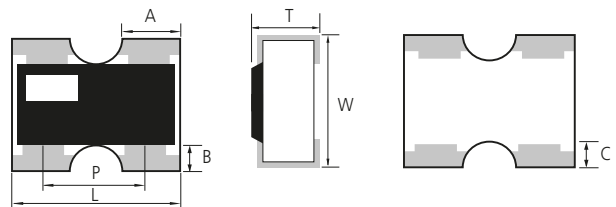

(UNIT: mm)

Type	Power(W)	L	W	T	A	B	C	P	Average Weight
RP10AT	0.04W / package	1.00 \pm 0.10	1.00 \pm 0.10	0.35 \pm 0.10	0.33 \pm 0.05	0.20 \pm 0.10	0.25 \pm 0.10	0.65 \pm 0.10	1.1mg

Parts Numbering System

- The part number system shall be in the following format

RP	10AT	L	A	03	CS
Code Designation	Dimensions & Circuit Configuration	Attenuation Value Tolerance	Characteristic Impedance	Attenuation Value	Packing Type
RP: Convex type	10:1.0 \times 1.0(mm)-0404(inch) AT: Unbalanced π -type Attenuator	L: \pm 0.3 dB H: \pm 0.5 dB	A: 50 ohm	3 dB EX) 0 \rightarrow 0dB	CS: Tape Packaging 7"

Specification

Item	Specifications
Attenuation Value	0 dB~15dB
Attenuation Value Tolerance	0 dB~5 dB : ± 0.3 dB 6 dB~15dB : ± 0.5 dB
Characteristic Impedance	50 Ω
Power Rating	0.04W / package
Frequency Range	DC to 3 GHz
VSWR (Voltage Standing Wave Ratio)	1.3 max
Number of terminals	4 terminals
Category Temperature Range (Operating Temperature Range)	-55 °C to +125 °C

Operation Notes

Example of land Pattern Design

Recommended Soldering Conditions

General Structure

General

Low ohms (RUT Series)

Ultra Low ohms (RU Series)

Ultra Low Ohms (RUK Series)

Ultra Low Ohms (RJ Series)

Arrays (CONVEX Type)

Arrays (CONCAVE Type)

Arrays (FLAT Type)

Anti-Sulfur Resistors

Anti-Sulfur Resistor Arrays(Convex Type)

Anti-Sulfur Resistor Arrays(Concave Type)

Anti-Sulfur Resistor Arrays (Flat Type)

Automotive Anti-sulfur

Automotive Anti-sulfur Arrays (Convex Type)

Attenuator

Characteristics Performance

Packaging

Standard Resistance Value

Power Derating Curve

The rated power is the maximum continuous loading power at 70°C ambient temperature. For ambient temperature above 70°C, the loading power follows the below power derating curve.

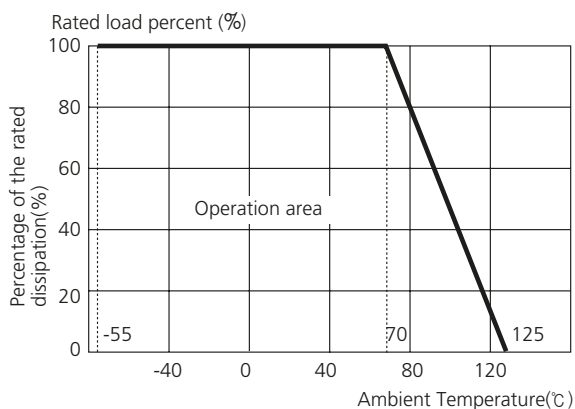

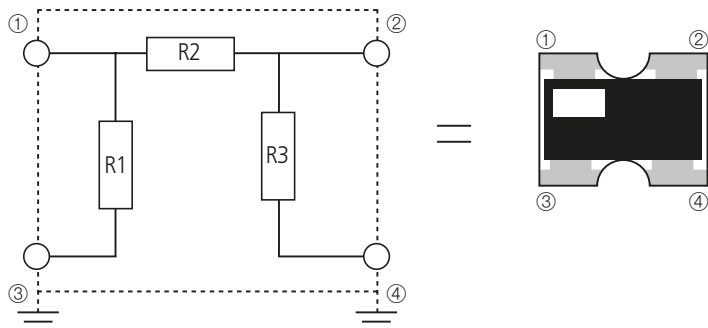

Equivalent Circuit Configuration

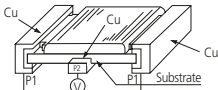

Electrical Characteristic

Item	Requirements Specification		Test Methods	
	Resistor	Jumper	Resistor	Jumper
Direct Current Resistance	Within the regulated resistance tolerance.	50mΩ Max.	JIS C 5201-1 4.5 Voltage apply Within 5 sec. Test temp: 20 °C, 65RH Test board: <FIG. 1>	
Temperature Characteristic	1Ω ≤ R < 10Ω : ±300ppm/°C 10Ω ≤ R ≤ 10MΩ : ±100ppm/°C (0201 size : ±250ppm/°C)		JIS C 5201-1 4.8 Test Temperature(°C) 20 °C → -55 °C / 20 °C → 125 °C T.C.R(ppm / °C)=(R-R ₂₀) / R ₂₀ × 1 / (T-T ₂₀) × 10 ⁶ ※ T=test Temperature, T ₂₀ =20 °C R=Resistance at T, R ₂₀ =Resistance at T ₂₀ Test board: <FIG. 1>	
Short-time Overload	ΔR	Less than ±(1% ± 0.1Ω) of the initial value.	JIS C 5201-1 4.13 Apply 2.5 times rated voltage for 5 sec. Wait 60 minutes at room temperature. Measure the resistance value. Test board: <FIG. 1>	Max Surge Current
	Visual	No evidence of mechanical damage.		
Intermittent Overload	ΔR	Less than ±(3% ± 0.1Ω) of the initial value.	JIS C 5201-1 4.13 2.5 times of rated voltage . 1 second ON, 25 second OFF. 10,000 cycles. Test board: <FIG. 1>	Max Surge Current
	Visual	No evidence of mechanical damage.		
Dielectric Withstanding Voltage	No evidence of mechanical damage.		JIS C 5201-1 4.7 Apply Voltage for 1 minute	
Insulation Resistance	Over 1,000MΩ		0402.0603:50V 1005, 1608: 100V Other: 500V	

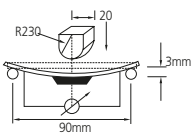
Mechanical Characteristic

Item	Requirements Specification		Test Methods	
	Resistor	Jumper	Resistor	Jumper
Solderability	Coverage: ≥95% each termination. No crack of termination parts and ceramic exposure of surface by melting.		IEC60068-2-58 Rosin Flux: Rosin 25%, Methanol 75% Solder Temp.: 245±5/-0 °C Dipping time: 2±0.5 sec.(Both side dipping)	
Bending Test	ΔR	Less than ±(1.0% ± 0.05Ω) of the initial value.	JIS C 5201-1 4.33 After soldering resistor on the PCB, 3mm of bending shall be applied for 10 sec. Test board: <FIG. 2>	
	Visual	No evidence of mechanical damage.		
Adhesive strength of termination	·No mechanical damage or sign of disconnection		JIS C 5201-1(4.16) - Test strength : 5N (500g · f), 0603 : 2N - Test time : Applying pressure for 10 seconds	
Resistance to Soldering Heat	ΔR	Less than ±(1% ± 0.05Ω) of the initial value.	JIS C 5201-1 4.18 - Flow soldering : 260±5 °C, 10 sec. max.(both side dipping) - Reflow soldering : 260±5 °C, 10 sec. max. over 230 °C, 30~40 sec.	
	Visual	No evidence of mechanical damage.		
Anti-Vibration Test	ΔR	Less than ±(1% ± 0.05Ω) of the initial value.	JIS C 5201-1 4.22 2 hours each in X, Y and Z axis(total 6 hours) 10 to 55Hz sweep in 1 minute at 1.5mm amplitude.	
	Visual	No evidence of mechanical damage.		

Environmental Characteristic

Item	Requirements Specification		Test Methods	
	Resistor	Jumper	Resistor	Jumper
Temperature Cycle	ΔR	Less than $\pm(1\% \pm 0.1\Omega)$ of the initial value.	50mΩ Max.	JIS C 5201-1 4.19 Perform 100 cycles as follows. Test Condition: -55°C / 30min ↔ 125°C / 30min sweep time: 5 min Test board: <FIG. 1>
	Visual	No evidence of mechanical damage.		
Load Life	ΔR	Less than $\pm(3\% \pm 0.1\Omega)$ of the initial value.	50mΩ Max.	JIS C 5201-1 4.25 Test Voltage: rated voltage Test temp.: 70±2°C Time: 1,000 ⁺⁴⁸ hours(90 min; ON, 30 min; OFF) Test board: <FIG. 1>
	Visual	No evidence of mechanical damage.		
Low Temp. Exposure	ΔR	Less than $\pm(3\% \pm 0.1\Omega)$ of the initial value.	50mΩ Max.	JIS C 5201-1 4.23 Dwell in -55°C chamber without loading for 1,000 ⁺⁴⁸ hours. Stabilize for 60 minutes at room temperature. Measure value. Test board: <FIG. 1>
	Visual	No evidence of mechanical damage.		
High Temp. Exposure	ΔR	Less than $\pm(3\% \pm 0.1\Omega)$ of the initial value.	50mΩ Max.	JIS C 5201-1 4.23 Dwell in 125°C ±2°C or 155°C ±2°C chamber without loading for 1,000 ⁺⁴⁸ hours. Stabilize for 60 minutes at room temperature. Measure value. Test board: <FIG. 1>
	Visual	No evidence of mechanical damage.		
Moisture Resistance	ΔR	Less than $\pm(3\% \pm 0.1\Omega)$ of the initial value.	50mΩ Max.	JIS C 5201-1 4.14 Test Voltage: rated voltage Test temp.: 40±2°C Time: 1,000 ⁺⁴⁸ hours(90 min; ON, 30 min; OFF) Humidity: 90~95% RH Stabilize for 1 hrs & Measure. Test board: <FIG. 1>
	Visual	No evidence of mechanical damage.		

* These characteristics apply to 1Ω ~10MΩ . In case of other resistance range, please contact us.

* The next is specification in our company for flow soldering and test boards.

Flow soldering Conditions

Item	Specification	Dipping
Flux	ROSIN 25%, IPA 75%	Time: 5~10 sec.
Solder	Sn-3.0Ag-0.5Cu	Time: 10 sec max. Temp.: 260±5°C.

Operation Notes

Example of land Pattern Design

Recommended Soldering Conditions

General Structure

General

Low ohms (RUT Series)

Ultra Low ohms (RU Series)

Ultra Low Ohms (RUK Series)

Ultra Low Ohms (RJ Series)

Arrays (CONVEX Type)

Arrays (CONCAVE Type)

Arrays (FLAT Type)

Anti-Sulfur Resistors

Anti-Sulfur Resistor Arrays(Convex Type)

Anti-Sulfur Resistor Arrays(Concave Type)

Anti-Sulfur Resistor Arrays (Flat Type)

Automotive Anti-sulfur

Automotive Anti-sulfur Arrays (Convex Type)

Attenuator

Characteristics Performance

Packaging

Standard Resistance Value

Taping Type

• Reel dimensions

Unit: mm

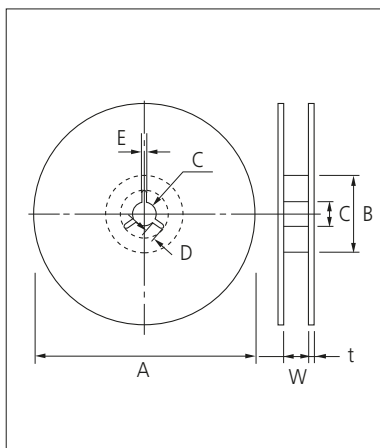

Symbol	Tape Width	A	B	C	D
7" Reel	8mm	$\varnothing 180+0/-3$	$\varnothing 60\pm 1.0$	$\varnothing 13.3\pm 0.3$	4 ± 0.2
	12mm	$\varnothing 180+0/-3$	$\varnothing 60\pm 1.0$	$\varnothing 13.3\pm 0.3$	4 ± 0.2
10" Reel	8mm	$\varnothing 258\pm 3$	$\varnothing 81\pm 1.0$	$\varnothing 13\pm 0.3$	4 ± 0.2
	12mm	$\varnothing 258\pm 3$	$\varnothing 81\pm 1.0$	$\varnothing 13\pm 0.3$	4 ± 0.2
13" Reel	8mm	$\varnothing 330\pm 2.0$	$\varnothing 100\pm 1.0$	$\varnothing 13\pm 0.5$	4 ± 0.2
	12mm	$\varnothing 330\pm 2.0$	$\varnothing 80\pm 1.0$	$\varnothing 13\pm 0.5$	4 ± 0.2

Symbol	Tape Width	E	W	t
7" Reel	8mm	2.0 ± 0.5	9 ± 0.5	1.2 ± 0.2
	12mm	2.0 ± 0.5	13 ± 0.5	1.2 ± 0.2
10" Reel	8mm	2.0 ± 0.5	9 ± 0.5	1.8 ± 0.2
	12mm	2.0 ± 0.5	13 ± 0.5	1.8 ± 0.2
13" Reel	8mm	3.3 ± 0.5	9 ± 0.5	2.2 ± 0.2
	12mm	3.3 ± 0.5	13 ± 0.5	2.2 ± 0.2

• Tape dimensions

(UNIT: mm)

Type	Pitch	Carrier Width	Dimensions																																																			
Pressed Paper	1mm	8mm		<table border="1"> <thead> <tr> <th>Type</th> <th>Size</th> <th>Size (inch)</th> <th>A</th> <th>B</th> <th>T</th> </tr> </thead> <tbody> <tr> <td rowspan="2">RC/RCS/RCM</td> <td>0402</td> <td>01005</td> <td>0.24 ± 0.03</td> <td>0.45 ± 0.03</td> <td>0.31 ± 0.02</td> </tr> <tr> <td>0603</td> <td>0201</td> <td>0.38 ± 0.05</td> <td>0.68 ± 0.05</td> <td>0.42 ± 0.05</td> </tr> </tbody> </table>	Type	Size	Size (inch)	A	B	T	RC/RCS/RCM	0402	01005	0.24 ± 0.03	0.45 ± 0.03	0.31 ± 0.02	0603	0201	0.38 ± 0.05	0.68 ± 0.05	0.42 ± 0.05																																	
	Type	Size	Size (inch)	A	B	T																																																
RC/RCS/RCM	0402	01005	0.24 ± 0.03	0.45 ± 0.03	0.31 ± 0.02																																																	
	0603	0201	0.38 ± 0.05	0.68 ± 0.05	0.42 ± 0.05																																																	
2mm	8mm		<table border="1"> <thead> <tr> <th>Type</th> <th>Size</th> <th>Size (inch)</th> <th>A</th> <th>B</th> <th>T</th> </tr> </thead> <tbody> <tr> <td rowspan="2">RC/RCS/RCM</td> <td>0402</td> <td>01005</td> <td>0.24 ± 0.03</td> <td>0.45 ± 0.03</td> <td>0.31 ± 0.02</td> </tr> <tr> <td>0603</td> <td>0201</td> <td>0.38 ± 0.05</td> <td>0.68 ± 0.05</td> <td>0.42 ± 0.05</td> </tr> </tbody> </table>	Type	Size	Size (inch)	A	B	T	RC/RCS/RCM	0402	01005	0.24 ± 0.03	0.45 ± 0.03	0.31 ± 0.02	0603	0201	0.38 ± 0.05	0.68 ± 0.05	0.42 ± 0.05																																		
Type	Size	Size (inch)	A	B	T																																																	
RC/RCS/RCM	0402	01005	0.24 ± 0.03	0.45 ± 0.03	0.31 ± 0.02																																																	
	0603	0201	0.38 ± 0.05	0.68 ± 0.05	0.42 ± 0.05																																																	
Punched Paper	2mm	8mm		<table border="1"> <thead> <tr> <th>Type</th> <th>Size</th> <th>Size (inch)</th> <th>A</th> <th>B</th> <th>T</th> </tr> </thead> <tbody> <tr> <td>RC/RCS/RCM /RU/RUT</td> <td>1005</td> <td>0402</td> <td>0.65 ± 0.10</td> <td>1.15 ± 0.10</td> <td>0.43 ± 0.07</td> </tr> <tr> <td rowspan="2">RF/RFS /RM/RMS</td> <td>062P</td> <td>0302</td> <td>0.70 ± 0.10</td> <td>0.90 ± 0.10</td> <td>0.30 ± 0.05</td> </tr> <tr> <td>064P</td> <td>0502</td> <td>0.70 ± 0.10</td> <td>1.60 ± 0.10</td> <td>0.30 ± 0.05</td> </tr> <tr> <td rowspan="2">RP/RPS/RPM</td> <td>102P</td> <td>0404</td> <td>1.17 ± 0.10</td> <td>1.20 ± 0.10</td> <td>0.43 ± 0.07</td> </tr> <tr> <td>104P</td> <td>0804</td> <td>1.20 ± 0.10</td> <td>2.20 ± 0.10</td> <td>0.43 ± 0.07</td> </tr> <tr> <td>10AT</td> <td>0404</td> <td>1.17 ± 0.10</td> <td>1.71 ± 0.10</td> <td>0.43 ± 0.07</td> </tr> <tr> <td rowspan="2">RN/RM/RK /RNS/RMS/RKS</td> <td>102P</td> <td>0404</td> <td>1.20 ± 0.10</td> <td>1.20 ± 0.10</td> <td>0.43 ± 0.07</td> </tr> <tr> <td>104P</td> <td>0804</td> <td>1.20 ± 0.10</td> <td>2.20 ± 0.10</td> <td>0.60 ± 0.10</td> </tr> </tbody> </table>	Type	Size	Size (inch)	A	B	T	RC/RCS/RCM /RU/RUT	1005	0402	0.65 ± 0.10	1.15 ± 0.10	0.43 ± 0.07	RF/RFS /RM/RMS	062P	0302	0.70 ± 0.10	0.90 ± 0.10	0.30 ± 0.05	064P	0502	0.70 ± 0.10	1.60 ± 0.10	0.30 ± 0.05	RP/RPS/RPM	102P	0404	1.17 ± 0.10	1.20 ± 0.10	0.43 ± 0.07	104P	0804	1.20 ± 0.10	2.20 ± 0.10	0.43 ± 0.07	10AT	0404	1.17 ± 0.10	1.71 ± 0.10	0.43 ± 0.07	RN/RM/RK /RNS/RMS/RKS	102P	0404	1.20 ± 0.10	1.20 ± 0.10	0.43 ± 0.07	104P	0804	1.20 ± 0.10	2.20 ± 0.10	0.60 ± 0.10
				Type	Size	Size (inch)	A	B	T																																													
				RC/RCS/RCM /RU/RUT	1005	0402	0.65 ± 0.10	1.15 ± 0.10	0.43 ± 0.07																																													
				RF/RFS /RM/RMS	062P	0302	0.70 ± 0.10	0.90 ± 0.10	0.30 ± 0.05																																													
					064P	0502	0.70 ± 0.10	1.60 ± 0.10	0.30 ± 0.05																																													
RP/RPS/RPM	102P	0404	1.17 ± 0.10	1.20 ± 0.10	0.43 ± 0.07																																																	
	104P	0804	1.20 ± 0.10	2.20 ± 0.10	0.43 ± 0.07																																																	
10AT	0404	1.17 ± 0.10	1.71 ± 0.10	0.43 ± 0.07																																																		
RN/RM/RK /RNS/RMS/RKS	102P	0404	1.20 ± 0.10	1.20 ± 0.10	0.43 ± 0.07																																																	
	104P	0804	1.20 ± 0.10	2.20 ± 0.10	0.60 ± 0.10																																																	
4mm	8mm		<table border="1"> <thead> <tr> <th>Type</th> <th>Size</th> <th>Size (inch)</th> <th>A</th> <th>B</th> <th>T</th> </tr> </thead> <tbody> <tr> <td rowspan="4">RC/RCS/RCM /RU/RUT/RUK /RJ</td> <td>1608</td> <td>0603</td> <td>1.10 ± 0.20</td> <td>1.90 ± 0.20</td> <td>0.60 ± 0.10</td> </tr> <tr> <td>0816</td> <td>0306</td> <td>1.10 ± 0.20</td> <td>1.90 ± 0.20</td> <td>0.60 ± 0.10</td> </tr> <tr> <td>2012</td> <td>0805</td> <td>1.65 ± 0.20</td> <td>2.40 ± 0.20</td> <td>0.75 ± 0.10</td> </tr> <tr> <td>1220</td> <td>0508</td> <td>1.65 ± 0.20</td> <td>2.40 ± 0.20</td> <td>0.75 ± 0.10</td> </tr> <tr> <td rowspan="2">3216</td> <td rowspan="2">1206</td> <td rowspan="2">0612</td> <td>2.00 ± 0.20</td> <td>3.60 ± 0.20</td> <td>0.75 ± 0.10</td> </tr> <tr> <td>2.00 ± 0.20</td> <td>3.60 ± 0.20</td> <td>0.75 ± 0.10</td> </tr> <tr> <td>3225</td> <td>1210</td> <td></td> <td>2.90 ± 0.20</td> <td>3.60 ± 0.20</td> <td>0.75 ± 0.10</td> </tr> <tr> <td>RC/RPS/RPM</td> <td>164P</td> <td>1206</td> <td>2.00 ± 0.20</td> <td>3.60 ± 0.20</td> <td>0.75 ± 0.10</td> </tr> </tbody> </table>	Type	Size	Size (inch)	A	B	T	RC/RCS/RCM /RU/RUT/RUK /RJ	1608	0603	1.10 ± 0.20	1.90 ± 0.20	0.60 ± 0.10	0816	0306	1.10 ± 0.20	1.90 ± 0.20	0.60 ± 0.10	2012	0805	1.65 ± 0.20	2.40 ± 0.20	0.75 ± 0.10	1220	0508	1.65 ± 0.20	2.40 ± 0.20	0.75 ± 0.10	3216	1206	0612	2.00 ± 0.20	3.60 ± 0.20	0.75 ± 0.10	2.00 ± 0.20	3.60 ± 0.20	0.75 ± 0.10	3225	1210		2.90 ± 0.20	3.60 ± 0.20	0.75 ± 0.10	RC/RPS/RPM	164P	1206	2.00 ± 0.20	3.60 ± 0.20	0.75 ± 0.10			
			Type	Size	Size (inch)	A	B	T																																														
			RC/RCS/RCM /RU/RUT/RUK /RJ	1608	0603	1.10 ± 0.20	1.90 ± 0.20	0.60 ± 0.10																																														
				0816	0306	1.10 ± 0.20	1.90 ± 0.20	0.60 ± 0.10																																														
				2012	0805	1.65 ± 0.20	2.40 ± 0.20	0.75 ± 0.10																																														
1220	0508	1.65 ± 0.20		2.40 ± 0.20	0.75 ± 0.10																																																	
3216	1206	0612	2.00 ± 0.20	3.60 ± 0.20	0.75 ± 0.10																																																	
			2.00 ± 0.20	3.60 ± 0.20	0.75 ± 0.10																																																	
3225	1210		2.90 ± 0.20	3.60 ± 0.20	0.75 ± 0.10																																																	
RC/RPS/RPM	164P	1206	2.00 ± 0.20	3.60 ± 0.20	0.75 ± 0.10																																																	
Embossed Plastic	4mm	12mm		<table border="1"> <thead> <tr> <th>Type</th> <th>Size</th> <th>Size (inch)</th> <th>A</th> <th>B</th> <th>T</th> </tr> </thead> <tbody> <tr> <td rowspan="4">RC/RCS/RCM /RU/RUT/RUK /RJ</td> <td>2037</td> <td>0815</td> <td>2.30 ± 0.20</td> <td>4.00 ± 0.20</td> <td>1.00 ± 0.10</td> </tr> <tr> <td>5025</td> <td>2010</td> <td>2.90 ± 0.20</td> <td>5.40 ± 0.20</td> <td>1.00 ± 0.10</td> </tr> <tr> <td rowspan="2">6432</td> <td rowspan="2">2512</td> <td rowspan="2">1225</td> <td>3.30 ± 0.20</td> <td>6.60 ± 0.20</td> <td>1.00 ± 0.10</td> </tr> <tr> <td>3.30 ± 0.20</td> <td>6.60 ± 0.20</td> <td>1.00 ± 0.10</td> </tr> </tbody> </table>	Type	Size	Size (inch)	A	B	T	RC/RCS/RCM /RU/RUT/RUK /RJ	2037	0815	2.30 ± 0.20	4.00 ± 0.20	1.00 ± 0.10	5025	2010	2.90 ± 0.20	5.40 ± 0.20	1.00 ± 0.10	6432	2512	1225	3.30 ± 0.20	6.60 ± 0.20	1.00 ± 0.10	3.30 ± 0.20	6.60 ± 0.20	1.00 ± 0.10																								
				Type	Size	Size (inch)	A	B	T																																													
				RC/RCS/RCM /RU/RUT/RUK /RJ	2037	0815	2.30 ± 0.20	4.00 ± 0.20	1.00 ± 0.10																																													
					5025	2010	2.90 ± 0.20	5.40 ± 0.20	1.00 ± 0.10																																													
6432	2512	1225	3.30 ± 0.20		6.60 ± 0.20	1.00 ± 0.10																																																
			3.30 ± 0.20		6.60 ± 0.20	1.00 ± 0.10																																																

Packaging Table

TYPE (mm)	TYPE (inch)	Taping Packaging					
		Code	Reel	Carrier Tape	Quantity	Weight(g)	
0402	01005	CS	7"	Pressed Paper	20,000	138	
0603	0201	CS	7"	Pressed Paper	15,000	121	
		DS	7"	Pressed Paper	20,000	149	
		DP	7"	Punched PE	20,000	149	
		AS	13"	Pressed Paper	60,000	573	
		FS	13"	Pressed Paper	50,000	474	
		FP	13"	Punched PE	50,000	474	
		WS	13"	Pressed Paper	150,000	695	
1005	0402	CS	7"	Punched Paper	10,000	87	
		DS	7"		20,000	147	
		DP	7"	Punched PE	20,000	147	
		ES	10"		30,000	331	
		AS	13"		40,000	539	
		FS	13"		50,000	548	
1608 0816*	0603 0306*	CS	7"	Punched Paper	5,000	120	
		ES	10"		10,000	324	
		AS	13"		20,000	561	
2012 1220*	0805 0508*	CS	7"		5,000	144	
		ES	10"		10,000	360	
		AS	13"		20,000	658	
3216 1632*	1206 0612*	CS	7"		5,000	152	
		ES	10"		10,000	382	
		AS	13"		20,000	695	
3225	1210	CS	7"		5,000	178	
		ES	10"		10,000	463	
		AS	13"		20,000	674	
2037*	0815*	CS	7"		Embossed Plastic	4,000	145
5025	2010	CS	7"			4,000	197
6432 3264*	2512 1225*	CS	7"			4,000	262
062P	0201X2R	CS	7"	Punched Paper	20,000	134	
		AS	13"		60,000	573	
064P	0201X2R	CS	7"		20,000	137	
		AS	13"		60,000	573	
102P	0402X2R	CS	7"		10,000	95	
		AS	13"		40,000	485	
104P	0402X4R	CS	7"		10,000	131	
		AS	13"		40,000	610	
164P	0603X4R	CS	7"		5,000	152	
		AS	13"		20,000	695	
10AT	0404	CS	7"		10,000	95	
		AS	13"		40,000	485	

- General type, Precision, Low ohms, High ohms.
- Packaging style can be modified when you want.
- (*) Wide Terminal Type

Operation
Notes

Example of land
Pattern Design

Recommended
Soldering Conditions

General Structure

General

Low ohms
(RUT Series)

Ultra Low ohms
(RU Series)

Ultra Low Ohms
(RUK Series)

Ultra Low Ohms
(RJ Series)

Arrays
(CONVEX Type)

Arrays
(CONCAVE Type)

Arrays
(FLAT Type)

Anti-Sulfur
Resistors

Anti-Sulfur Resistor
Arrays(Convex Type)

Anti-Sulfur Resistor
Arrays(Concave Type)

Anti-Sulfur Resistor
Arrays (Flat Type)

Automotive
Anti-sulfur

Automotive Anti-sulfur
Arrays (Convex Type)

Attenuator

Characteristics
Performance

Packaging

Standard
Resistance Value

The specifications and designs contained herein may be subject to change without notice.
Please contact our sales representatives or product engineers before order.

Standard Resistance Value

Tolerance Code Table

Tolerance Code	D	F	G	J	K	M
Digit Number	4 digit			3 digit		
IEC-Code System	E-192	E-96	E-48	E-24	E-12	E-6
Specification	±0.5%	±1%	±2%	±5%	±10%	±20%

Significant Figure of Resistance Value

E-192	E-96	E-48	E-24	E-192	E-96	E-48	E-24	E-192	E-96	E-48	E-24	E-192	E-96	E-48	E-24
100	100	100	10	178	178	178		316	316	316		562	562	562	56
101				180			18	320				569			
102	102			182	182			324	324			576	576		
104				184				328				583			
105	105	105		187	187	187		332	332	332	33	590	590	590	
106				189				336				597			
107	107			191	191			340	340			604	604		
109				193				344				612			
110	110	110	11	196	196	196		348	348	348		619	619	619	
111				198				352				626			62
113	113			200	200		20	357	357			634	634		
114				203				361				642			
115	115	115		205	205	205		365	365	365		649	649	649	
117				208				370				657			
118	118			210	210			374	374			665	665		
120			12	213				379				673			
121	121	121		215	215	215		383	383	383		681	681	681	68
123				218				388				690			
124	124			221	221		22	392	392		39	698	698		
126				223				397				706			
127	127	127		226	226	226		402	402	402		715	715	715	
129				229				407				723			
130	130		13	232	232			412	412			732	732		
132				234				417				741			
133	133	133		237	237	237		422	422	422		750	750	750	75
135				240			24	427				759			
137	137			243	243			432	432		43	768	768		
138				246				437				777			
140	140	140		249	249	249		442	442	442		787	787	787	
142				252				448				796			
143	143			255	255			453	453			806	806		
145				258				459				816			
147	147	147		261	261	261		464	464	464		825	825	825	82
149				264				470			47	835			
150	150		15	267	267			475	475			845	845		
152				271			27	481				856			
154	154	154		274	274	274		487	487	487		866	866	866	
156				277				493				876			
158	158			280	280			499	499			887	887		
160			16	284				505				898			
162	162	162		287	287	287		511	511	511	51	909	909	909	
164				291				517				920			91
165	165			294	294			523	523			931	931		
167				298				530				942			
169	169	169		301	301	301	30	536	536	536		953	953	953	
172				305				542				965			
174	174			309	309			549	549			976	976		
176				312				556				988			

• Example

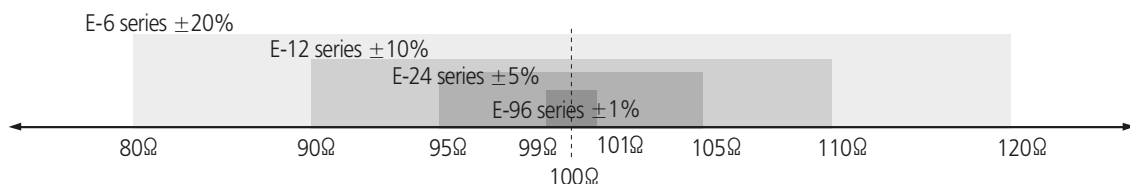

Operation
Notes

Example of land
Pattern Design

Recommended
Soldering Conditions

General Structure

General

Low ohms
(RUT Series)

Ultra Low ohms
(RU Series)

Ultra Low Ohms
(RUK Series)

Ultra Low Ohms
(RJ Series)

Arrays
(CONVEX Type)

Arrays
(CONCAVE Type)

Arrays
(FLAT Type)

Anti-Sulfur
Resistors

Anti-Sulfur Resistor
Arrays(Convex Type)

Anti-Sulfur Resistor
Arrays(Concave Type)

Anti-Sulfur Resistor
Arrays (Flat Type)

Automotive
Anti-sulfur

Automotive Anti-sulfur
Arrays (Convex Type)

Attenuator

Characteristics
Performance

Packaging

**Standard
Resistance Value**

 **Attention**

1. This catalogue is valid only to the products purchased either from us or through our official distributors.
2. Product specifications included in this catalogue are effective as of May 1, 2015.
Please be advised that they are standard product specifications for reference only.
We may change, modify or discontinue the product specifications without notice at any time.
So, you need to approve the product specifications before placing an order. Should you have any question regarding our product specifications, please contact our sales personnel or application engineers.
3. We may modify or cease to produce the products listed in this catalogue without notice. Should you have any question, please contact our sales personnel or application engineers.
4. Without obtaining our permission, you should not be allowed to reproduce, copy, use or transfer any content or information contained this catalogue in any manner whatsoever for any purpose.
5. In no event, will we be responsible for any claim, dispute, damage or liability whatsoever arising from, relating to or in connection with your misuse of the products or/and information included in this catalogue.
We will also not assume any responsibilities whatsoever for any claim, dispute, damage or liability with regards to the intellectual property rights or other related rights of ours or any third party associated with your use of our products and/or information contained in this catalogue. We expressly disclaim that no license is granted regarding the aforementioned rights.
6. Please note that the products in this catalogue are not designed or intended to use for the applications set forth below. So, if you intend to use the products in this catalogue for the applications listed below, you should contact our sales personnel or application engineers before using.
Please be aware that any misuse of the products deviating from product specifications or information provided in this catalogue may cause a serious property damage or a personal injury.
 - ① Aerospace/Aviation equipment
 - ② Transportation equipment (vehicles, trains, ships, etc)
 - ③ Medical equipment
 - ④ Military equipment
 - ⑤ Disaster prevention/crime prevention equipment
 - ⑥ Any other applications with the same as or similar complexity or reliability to the applications set forth above.

ISO/TS 16949

ISO 14001

OHSAS 18001

QC080000

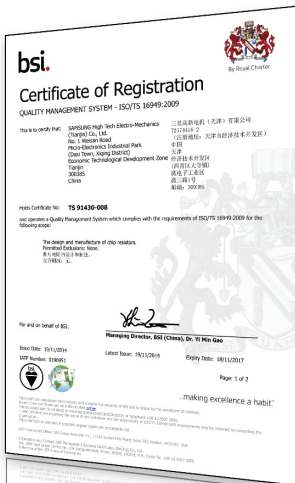

Quality System Certification List

Table 1: Certification list of Samsung Factory

Certification	Section	High Tech(China)
ISO / TS 16949	Authority	BSI
	Number	TS 91430-008
	Date	2014 - 11 - 19
	Validity	2017 - 11 - 18
ISO 14001	Authority	BSI
	Number	EMS 585307
	Date	2015 - 04 - 15
	Validity	2018 - 04 - 14
OHSAS 18001	Authority	BSI
	Number	OHS 585308
	Date	2015 - 04 - 15
	Validity	2018 - 04 - 14
QC080000	Authority	UL
	Number	PRC-HSPM-1767-1
	Date	2013 - 07 - 08
	Validity	2016 - 07 - 26



Passive components sales offices

• Head office

206, Cheomdansaneop Road,
Yeongtong-gu, Suwon-city,
Gyeonggi province, Korea,
443 - 743

Europe

Tel: + 82 - 31 - 210 - 6328
E-mail:james.pyun@samsung.com

America

Tel: + 82 - 31 - 210 - 6803
E-mail:wesley.rohi@samsung.com

Asia

Tel: + 82 - 31 - 210 - 6791
E-mail:peter_kim@samsung.com

Domestic

Tel: + 82 - 31 - 210 - 5074
E-mail:boungho.leel@samsung.com

• Manufacturing sites

Suwon Plant (Korea)

206, Cheomdansaneop Road,
Yeongtong - gu, Suwon-city,
Gyeonggi province, Korea
443 - 743
Tel: + 82 - 31 - 210 - 5074
E-mail:boungho.leel@samsung.com

Busan Plant (Korea)

1623 - 2, Songjeong - dong,
Gangseo - gu, Busan, Korea,
618 - 270
Tel: + 82 - 51 - 970 - 7671
E-mail:kyc.kweoni@samsung.com

Tianjin Plant (China)

27, Heiniucheng - Road, Hexi District,
Tianjin, 300210 China
Tel: +86 - 22 - 2397 - 9000(310)
E-mail:moohantop.Park@samsung.com

High Tech (China)

Xiqing Dist. Micro - Electronics
Industrial Park, Jingang Highway,
Tianjin, China 300385
Tel:+ 86 - 22 - 2397 - 9000(3143)
E-mail:enhao.song@samsung.com

Binhai Plant(China)

80, Xiaqing Road, West area of
BinHai development zone,
TianJin, 300458, China
Tel:+ 86 - 22 - 6686 - 3333(1300)
E-mail:sk1000.kim@samsung.com

Philippines Plant (Philippines)

Block No.5, Calamba Premiere
International Park, Batino, Calamba,
Laguna, Manila, Philippines 4027
Tel: + 63 - 49 - 545 - 0422
E-mail:donna@samsung.com

• Asia sales offices

Shenzhen Office

46 F, New World Center,
Yitian Road, Futian District,
Shenzhen, 518026 China
Tel: 86 - 755 - 8608 - 5571
E-mail:jackson.xian@samsung.com

Shanghai Office

Rm. 1211, Shanghai International
Trade Center, No. 2201 Yan an (W) Rd.,
Shanghai, 200335 China
Tel: 86 - 21 - 6270 - 4168(274)
E-mail:dennis.cha@samsung.com

HongKong Office

8/F., Central Plaza, 18 Harbour Road,
Wanchai, Hongkong, China
Tel:852 - 28626344
E-mail:vivianchan@samsung.com

Qingdao Office

Rm 1201, Growne Plaza Qingdao 76,
Xiang Gang Zhong Rd, Qingdao,
266071 China
Tel:86 - 85779102
E-mail:zhengguo.cui@samsung.com

Taiwan Office

9F - 1, Np. 399 Ruey Kuang Rd., Neihu
District, Taipei City, Taiwan, 114
Tel:886 - 2656 - 8356
E-mail:kevin0130.wang@samsung.com

Singapore Office

3 Church Street Samsung Hub,
#23 - 02 Singapore 049483
Tel:65 - 6833 - 3228
E-mail:winson.yeong@samsung.com

Bangkok Office

23rd Floor, Lake Rajada Office Complex
193/89 Rachadapisek Road,
Khet Klongtoey, Bangkok 10110, Thailand
Tel:66 - 2 - 661 - 8004 ~ 5
E-mail:yangshin.yi@samsung.com

• America sales office

Irvine Office

3333 Michelson Drive,
Suite 500, Irvine, CA 92612, USA
Tel: 1 - 949 - 797 - 8016
E-mail: andrew.skelly@samsung.com

• Europe sales offices

Frankfurt Office

Samsung Haus, Am Kronberger Hang 6,
D-65824 Schwalbach/Ts. Germany
Tel: 49 - 6196 - 66 - 7255
E-mail:frank.goebel@samsung.com

Hungary Office

H-2310, Leshegy utca 2-4,
Szigetszentmiklos, Pest megye, Hungary
Tel: 36 - 24 - 551 - 148
E-mail:jun21c.leel@samsung.com

• Domestic Distributors

Korchip Corporation

817 - 38, Anyang 2 - dong, Manan - gu,
Anyang-city, Gyeonggi province,
Korea, 430-812
Tel: + 82 - 31 - 361 - 8100
E-mail:itasapi@korchip.com

SAMT

Daekyung Bldg., 983 - 10, Daechi - dong,
Gangnam - gu, Seoul, Korea
Tel: + 82 - 2 - 3458 - 9000
E-mail:info@isamt.com

CHUNGMAC

301 Gwonseon Medivill, 544-14
Gokbanjeong-dong, Gwonseon-gu,
Suwon-si, Gyeonggi-do Korea
Tel: + 82 - 31 - 234 - 2367~8
E-mail:webmaster@chungmac.co.kr

YOUNGDUK

Gasan-Dong 632, Seobusaetgil,
Geumcheon-Gu, Seoul, Korea
Tel: + 82 - 2 - 2107 - 7860
E-mail:siyang1109@gmail.com