



■ Features

- Constant Current mode output
- Metal housing with Class I design
- Built-in active PFC function
- IP67 / IP65 design for indoor or outdoor installations
- Function options: output adjustable via potentiometer; 3 in 1 dimming
- Typical lifetime > 62000 hours
- 7 years warranty

■ Applications

- LED street lighting
- LED fishing lamp
- LED harbor lighting
- LED building architectural lighting
- LED greenhouse lighting
- LED bay lighting
- Type “HL” for use in Class I , Division 2 hazardous (Classified) location.

■ Description

HLG-320H-C series is a 320W LED AC/DC LED driver featuring the constant current mode and high voltage output. HLG-320H-C operates from 90~305VAC and offers models with different rated current ranging between 700mA and 3500mA. Thanks to the high efficiency up to 94%, with the fanless design, the entire series is able to operate for -40°C ~ +85°C case temperature under free air convection. The design of metal housing and IP67/IP65 ingress protection level allows this series to fit both indoor and outdoor applications. HLG-320H-C is equipped with various function options, such as dimming methodologies, so as to provide the optimal design flexibility for LED lighting system.

■ Model Encoding

HLG - 320H - C1050 A

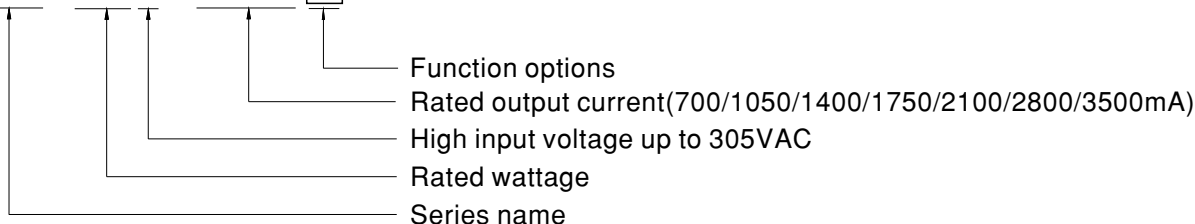

Type	IP Level	Function	Note
A	IP65	Io adjustable through built-in potentiometer.	In Stock
B	IP67	3 in 1 dimming function (0~10Vdc, 10V PWM signal and resistance)	In Stock
DA	IP67	DALI control technology.	In Stock
AB	IP65	Io adjustable through built-in potentiometer & 3 in 1 dimming function (0~10Vdc, 10V PWM signal and resistance)	In Stock
Dx	IP67	Built-in Smart timer dimming function by user request.	By request
D2	IP67	Built-in Smart timer dimming and programmable function.	In Stock



SPECIFICATION

MODEL		HLG-320H-C700 <input type="checkbox"/>	HLG-320H-C1050 <input type="checkbox"/>	HLG-320H-C1400 <input type="checkbox"/>	HLG-320H-C1750 <input type="checkbox"/>	HLG-320H-C2100 <input type="checkbox"/>	HLG-320H-C2800 <input type="checkbox"/>	HLG-320H-C3500 <input type="checkbox"/>
OUTPUT	RATED CURRENT	700mA	1050mA	1400mA	1750mA	2100mA	2800mA	3500mA
	RATED POWER	299.6W	320.25W	320.6W	320.25W	319.2W	319.2W	318.5W
	CONSTANT CURRENT REGION <small>Note.2</small>	214 ~ 428V	152 ~ 305V	114 ~ 229V	91 ~ 183V	76 ~ 152V	57 ~ 114V	46 ~ 91V
	OPEN CIRCUIT VOLTAGE (max.)	435V	311V	234V	187V	156V	118V	95V
	CURRENT ADJ. RANGE	Adjustable for A/AB-Type only (via built-in potentiometer)						
		350 ~ 700mA	525 ~ 1050mA	700 ~ 1400mA	875 ~ 1750mA	1050 ~ 2100mA	1400 ~ 2800mA	1750 ~ 3500mA
	CURRENT RIPPLE	5.0% max. @rated current						
	CURRENT TOLERANCE	±5%						
SET UP TIME <small>Note.4</small>	1000ms/115VAC, or 500ms/230VAC							
INPUT	VOLTAGE RANGE <small>Note.3</small>	90 ~ 305VAC 127 ~ 431VDC (Please refer to "STATIC CHARACTERISTIC" section)						
	FREQUENCY RANGE	47 ~ 63Hz						
	POWER FACTOR (Typ.)	PF ≥ 0.98/115VAC, PF ≥ 0.95/230VAC, PF ≥ 0.92/277VAC @full load (Please refer to "POWER FACTOR (PF) CHARACTERISTIC" section)						
	TOTAL HARMONIC DISTORTION	THD < 20% (@ load ≥ 50% /115VAC, 230VAC; @ load ≥ 70%/277VAC) (Please refer to "TOTAL HARMONIC DISTORTION (THD)" section)						
	EFFICIENCY (Typ.)	94%	94%	94%	94%	94%	94%	94%
	AC CURRENT (Typ.)	3.5A / 115VAC	1.65A / 230VAC	1.45A / 277VAC				
	INRUSH CURRENT(Typ.)	COLD START 70A(<small>t</small> width=1200μs measured at 50% I _{peak}) at 230VAC; Per NEMA 410						
	MAX. No. of PSUs on 16A CIRCUIT BREAKER	2 units (circuit breaker of type B) / 3 units (circuit breaker of type C) at 230VAC						
	LEAKAGE CURRENT	<0.75mA / 277VAC						
PROTECTION	SHORT CIRCUIT	Constant current limiting, recovers automatically after fault condition is removed						
	OVER VOLTAGE	436 ~ 460V	320 ~ 352V	235 ~ 252V	192 ~ 211V	160 ~ 175V	120 ~ 132V	96 ~ 105V
	OVER TEMPERATURE	Shut down and latch off o/p voltage, re-power on to recover						
ENVIRONMENT	WORKING TEMP.	T _{case} =-40 ~ +85°C (Please refer to "OUTPUT LOAD vs TEMPERATURE" section)						
	MAX. CASE TEMP.	T _{case} =+85°C						
	WORKING HUMIDITY	20 ~ 95% RH non-condensing						
	STORAGE TEMP., HUMIDITY	-40 ~ +80°C, 10 ~ 95% RH						
	TEMP. COEFFICIENT	±0.03%/°C (0 ~ 50°C)						
	VIBRATION	10 ~ 500Hz, 5G 12min./1cycle, period for 72min. each along X, Y, Z axes						
SAFETY & EMC	SAFETY STANDARDS	UL8750(type"HL"), CSA C22.2 No. 250.13-12; ENEC EN61347-1, EN61347-2-13, EN62384 independent; GB19510.1, GB19510.14, EAC TP TC 004, IP65 or IP67 approved						
	WITHSTAND VOLTAGE	I/P-O/P:3.75KVAC I/P-FG:2KVAC O/P-FG:1.5KVAC						
	ISOLATION RESISTANCE	I/P-O/P, I/P-FG, O/P-FG:100M Ohms / 500VDC / 25°C / 70% RH						
	EMC EMISSION	Compliance to EN55015, EN61000-3-2 Class C (@ load ≥ 50%) ; EN61000-3-3, GB17743 and GB17625.1, EAC TP TC 020						
	EMC IMMUNITY	Compliance to EN61000-4-2,3,4,5,6,8,11, EN61547, light industry level (surge immunity Line-Earth 4KV, Line-Line 2KV), EAC TP TC 020						
OTHERS	MTBF	168.2K hrs min. MIL-HDBK-217F (25°C)						
	DIMENSION	252*90*43.8mm (L*W*H)						
	PACKING	1.88Kg; 8pcs/16Kg/0.92CUFT						
NOTE	<ol style="list-style-type: none"> All parameters NOT specially mentioned are measured at 230VAC input, rated current and 25°C of ambient temperature. Please refer to "DRIVING METHODS OF LED MODULE". De-rating may be needed under low input voltages. Please refer to "STATIC CHARACTERISTIC" sections for details. Length of set up time is measured at first cold start. Turning ON/OFF the driver may lead to increase of the set up time. The driver is considered as a component that will be operated in combination with final equipment. Since EMC performance will be affected by the complete installation, the final equipment manufacturers must re-qualify EMC Directive on the complete installation again. To fulfill requirements of the latest ErP regulation for lighting fixtures, this LED driver can only be used behind a switch without permanently connected to the mains. This series meets the typical life expectancy of >62,000 hours of operation when T_{case}, particularly (t_c) point (or TMP, per DLC), is about 75°C or less. Please refer to the warranty statement on MEAN WELL's website at http://www.meanwell.com The ambient temperature derating of 3.5°C/1000m with fanless models and of 5°C/1000m with fan models for operating altitude higher than 2000m(6500ft). 							

■ BLOCK DIAGRAM

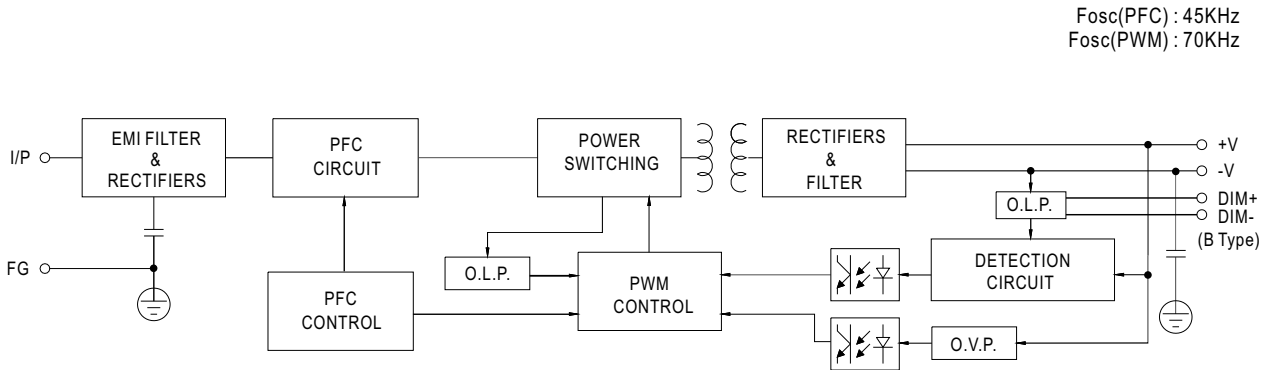

■ DRIVING METHODS OF LED MODULE

※ This series works in constant current mode to directly drive the LEDs.

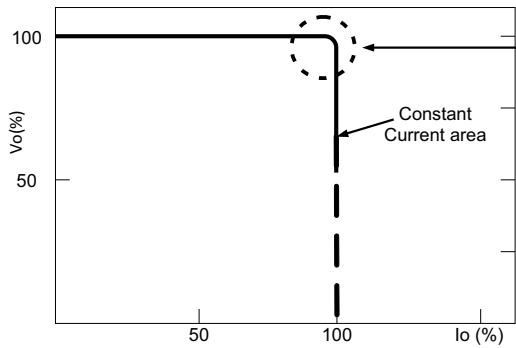

Typical output current normalized by rated current (%)

In the constant current region, the highest voltage at the output of the driver depends on the configuration of the end systems.

Should there be any compatibility issues, please contact MEAN WELL.

■ DIMMING OPERATION

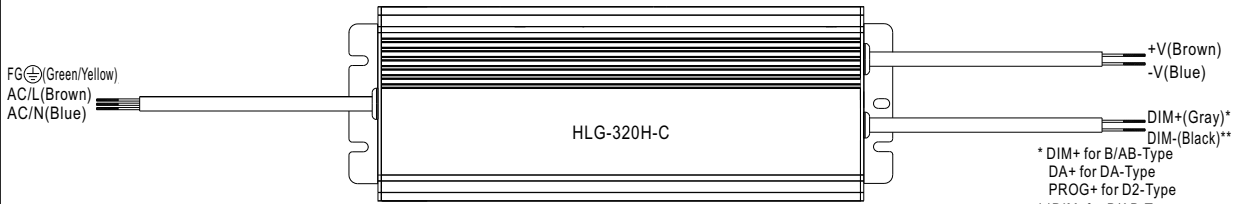

※ 3 in 1 dimming function (for B/AB-Type)

- Output constant current level can be adjusted by applying one of the three methodologies between DIM+ and DIM-: 0 ~ 10VDC, or 10V PWM signal or resistance.
- Direct connecting to LEDs is suggested. It is not suitable to be used with additional drivers.
- Dimming source current from power supply: 100μA (typ.)

◎ Applying additive 0 ~ 10VDC

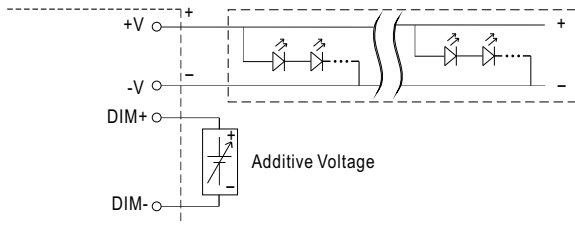

"DO NOT connect "DIM- to -V"

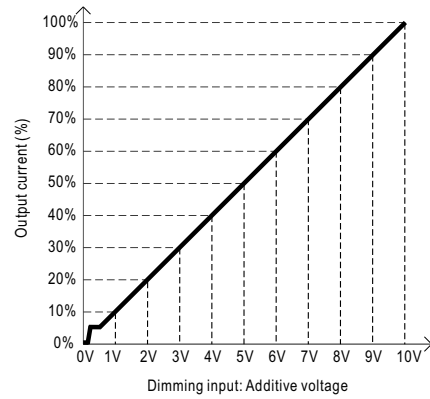

◎ Applying additive 10V PWM signal (frequency range 100Hz ~ 3KHz):

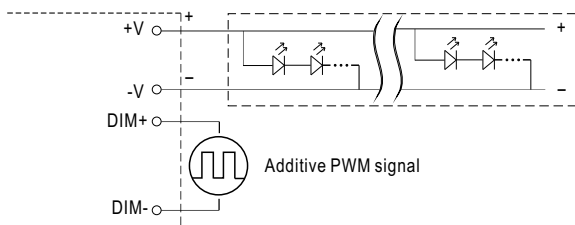

"DO NOT connect "DIM- to -V"

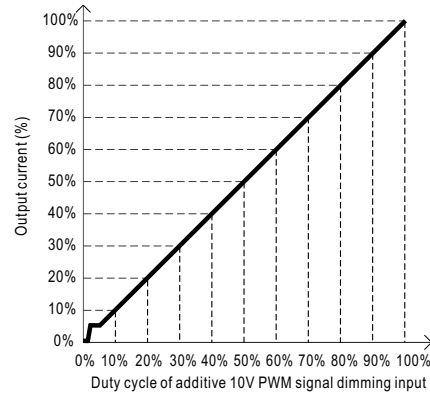

◎ Applying additive resistance:

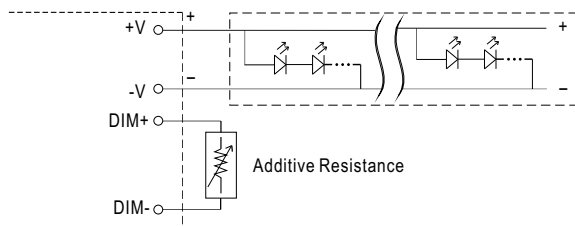

"DO NOT connect "DIM- to -V"

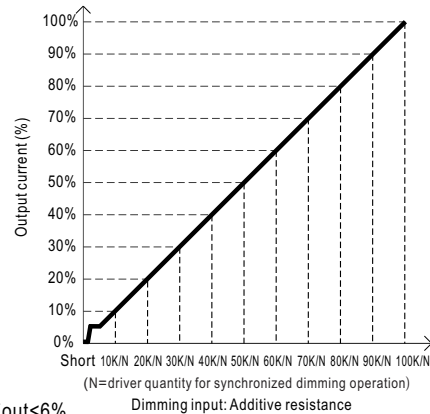

Note : 1. Min. dimming level is about 6% and the output current is not defined when 0% < Iout < 6%.

2. The output current could drop down to 0% when dimming input is about 0kΩ or 0Vdc, or 10V PWM signal with 0% duty cycle.

※ **DALI Interface (primary side; for DA-Type)**

- Apply DALI signal between DA+ and DA-.
- DALI protocol comprises 16 groups and 64 addresses.
- First step is fixed at 8% of output. Please contact MEAN WELL for other setup.

※ **Smart timer dimming function (for Dxx-Type by User definition)**

MEAN WELL Smart timer dimming primarily provides the adaptive proportion dimming profile for the output constant current level to perform up to 14 consecutive hours. 3 dimming profiles hereunder are defined accounting for the most frequently seen applications. If other options may be needed, please contact MEAN WELL for details.

Ex : ☉ D01-Type: the profile recommended for residential lighting



Set up for D01-Type in Smart timer dimming software program:

	T1	T2	T3	T4
TIME**	06:00	07:00	11:00	---
LEVEL**	100%	70%	50%	70%

** : TIME matches Operating Time in the diagram whereas LEVEL matches Dimming Level.

Example: If a residential lighting application adopts D01-Type, when turning on the power supply at 6:00pm, for instance:

- [1] The power supply will switch to the constant current level at 100% starting from 6:00pm.
- [2] The power supply will switch to the constant current level at 70% in turn, starting from 0:00am, which is 06:00 after the power supply turns on.
- [3] The power supply will switch to the constant current level at 50% in turn, starting from 1:00am, which is 07:00 after the power supply turns on.
- [4] The power supply will switch to the constant current level at 70% in turn, starting from 5:00am, which is 11:00 after the power supply turns on.

The constant current level remains till 8:00am, which is 14:00 after the power supply turns on.

Ex : ☉ D02-Type: the profile recommended for street lighting

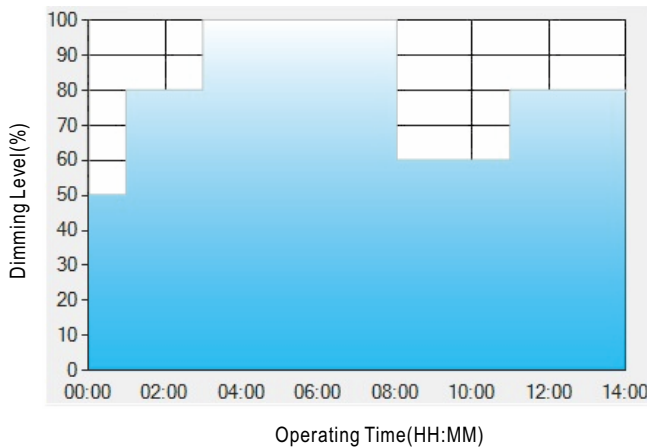

Set up for D02-Type in Smart timer dimming software program:

	T1	T2	T3	T4	T5
TIME**	01:00	03:00	8:00	11:00	---
LEVEL**	50%	80%	100%	60%	80%

** : TIME matches Operating Time in the diagram whereas LEVEL matches Dimming Level.

Example: If a street lighting application adopts D02-Type, when turning on the power supply at 5:00pm, for instance:

- [1] The power supply will switch to the constant current level at 50% starting from 5:00pm.
- [2] The power supply will switch to the constant current level at 80% in turn, starting from 6:00pm, which is 01:00 after the power supply turns on.
- [3] The power supply will switch to the constant current level at 100% in turn, starting from 8:00pm, which is 03:00 after the power supply turns on.
- [4] The power supply will switch to the constant current level at 60% in turn, starting from 1:00am, which is 08:00 after the power supply turns on.
- [5] The power supply will switch to the constant current level at 80% in turn, starting from 4:00am, which is 11:00 after the power supply turns on. The constant current level remains till 6:30am, which is 14:00 after the power supply turns on.

Ex: © D03-Type: the profile recommended for tunnel lighting

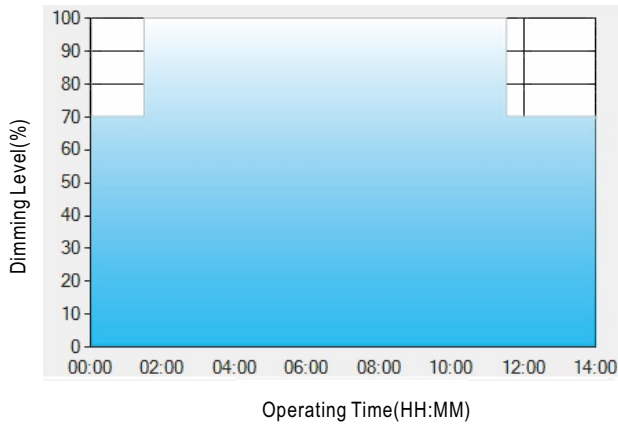

Set up for D03-Type in Smart timer dimming software program:

	T1	T2	T3
TIME**	01:30	11:00	---
LEVEL**	70%	100%	70%

** : TIME matches Operating Time in the diagram whereas LEVEL matches Dimming Level.

Example: If a tunnel lighting application adopts D03-Type, when turning on the power supply at 4:30pm, for instance:

[1] The power supply will switch to the constant current level at 70% starting from 4:30pm.

[2] The power supply will switch to the constant current level at 100% in turn, starting from 6:00pm, which is 01:30 after the power supply turns on.

[3] The power supply will switch to the constant current level at 70% in turn, starting from 5:00am, which is 11:00 after the power supply turns on.

The constant current level remains till 6:30am, which is 14:00 after the power supply turns on.

OUTPUT LOAD vs TEMPERATURE(Note.8)

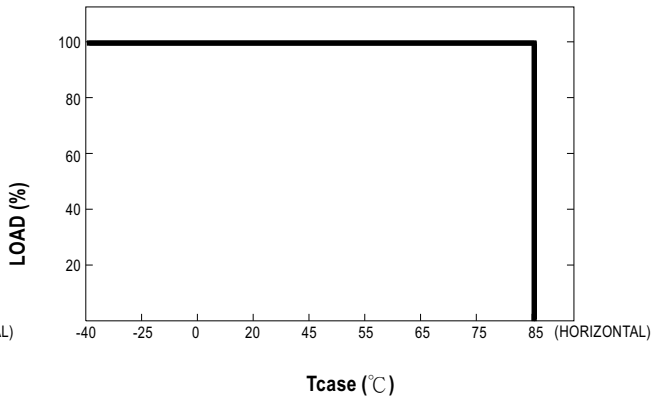
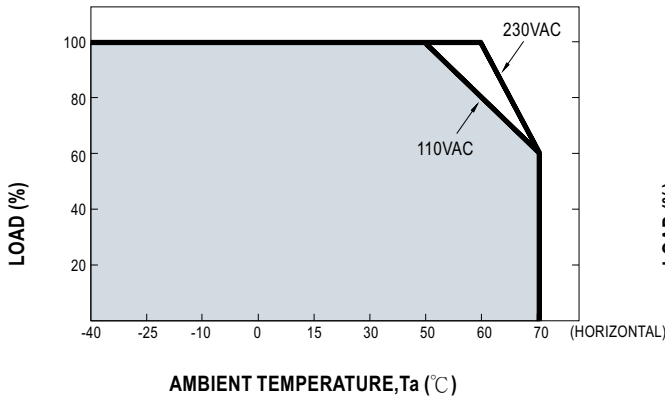

STATIC CHARACTERISTIC

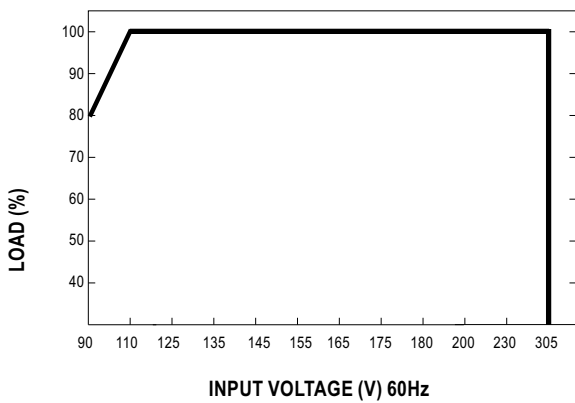

POWER FACTOR (PF) CHARACTERISTIC

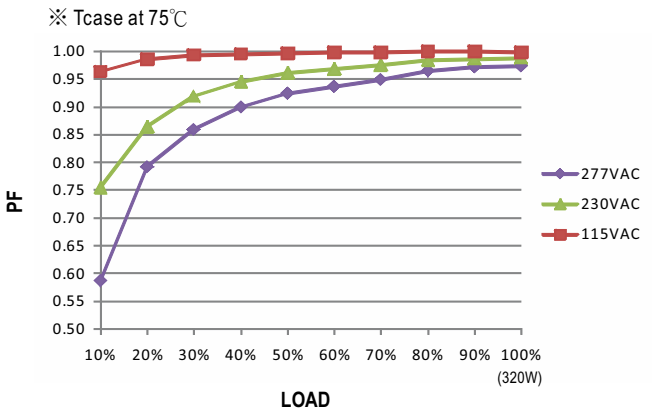

TOTAL HARMONIC DISTORTION (THD)

※ 1050mA Model, Tcase at 75°C

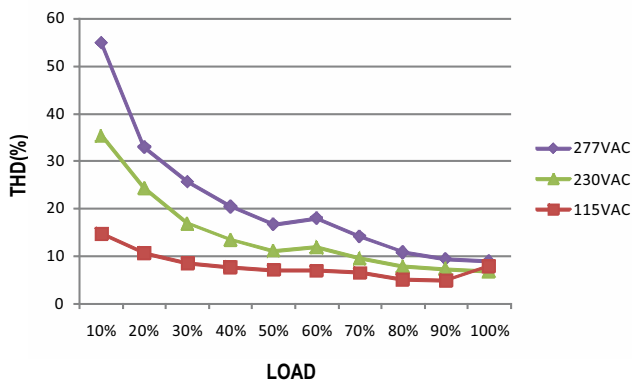

EFFICIENCY vs LOAD

HLG-320H-C series possess superior working efficiency that up to 94% can be reached in field applications.

※ 1050mA Model, Tcase at 75°C

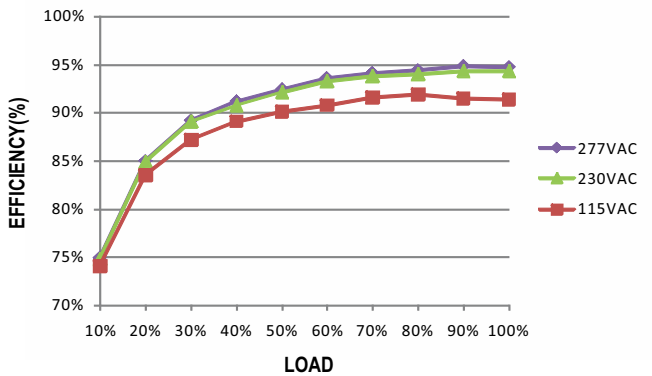



■ LIFE TIME

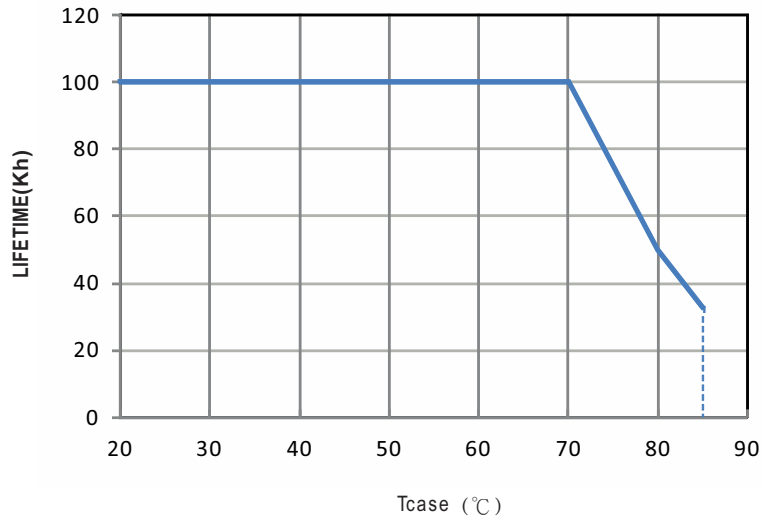

MECHANICAL SPECIFICATION

Case No.228 Unit:mm

※ **A-Type**

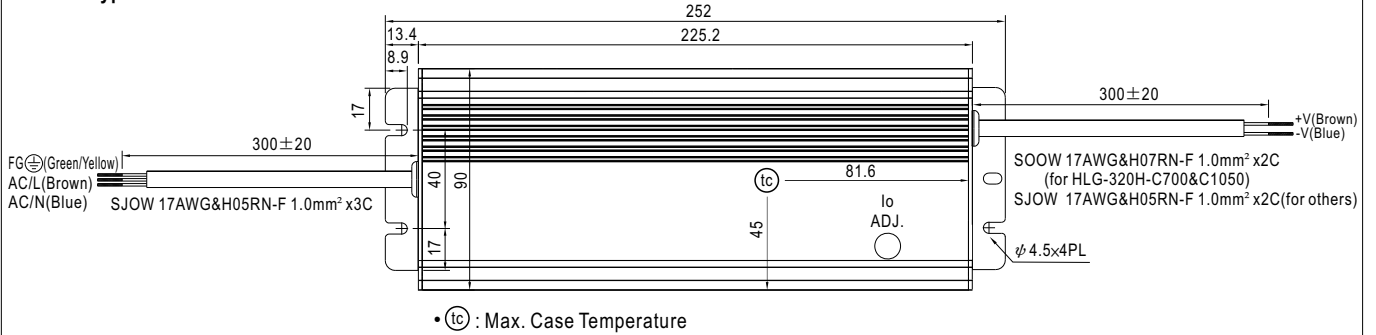

※ **AB-Type**

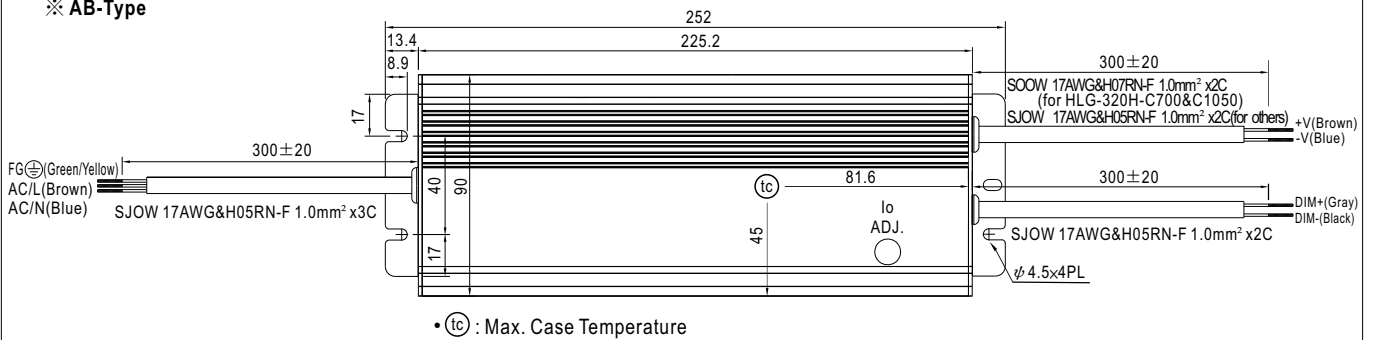

※ **B/DA/D2-Type**

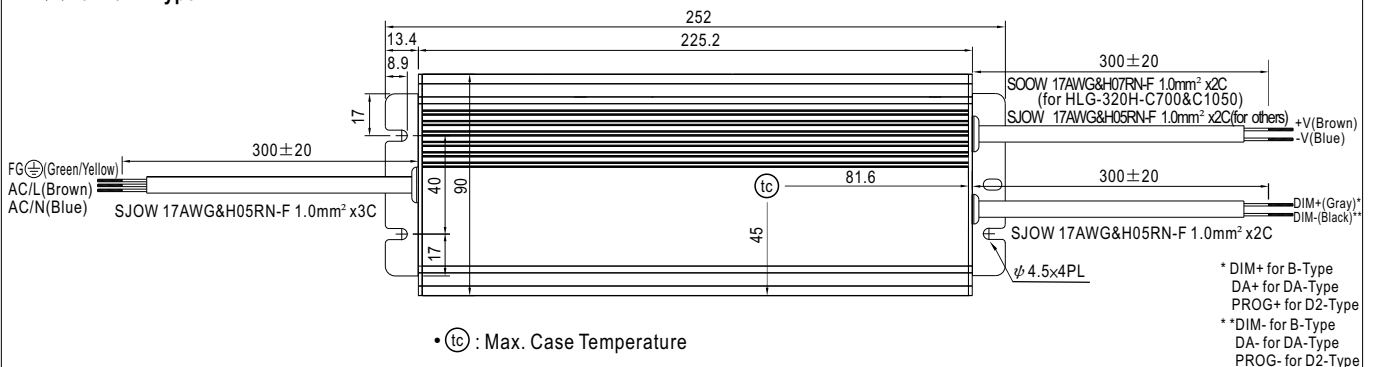

INSTALLATION MANUAL

Please refer to: <http://www.meanwell.com/manual.html>