

MATERIAL NO.	ENGINEERING NO.	LENGTH	POLES
1206144003	LW03006C02M020	78.7 (2M)	3
1206144004	LW04006C02M020	78.7 (2M)	4

NOTICE: THIS PART IS CSA AND FACTORY MUTUAL APPROVED  
NO CHANGES CAN BE MADE TO THE ASSEMBLY, COMPONENTS  
OR SUPPLIER WITHOUT PRIOR APPROVAL FROM CSA AND  
FACTORY MUTUAL.

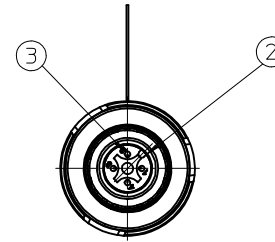
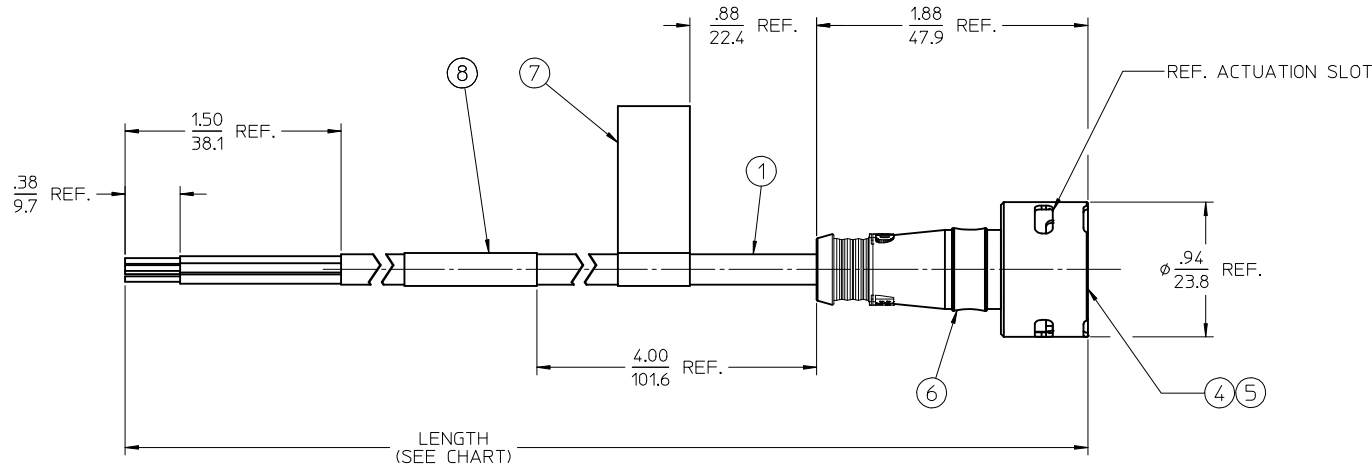
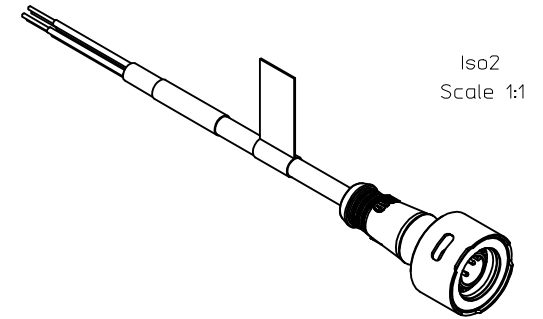

② LW0X006C02MXXX

SINGLE END  
POLE QTY.  
HEAD STYLE  
CABLE TYPE  
FINISHED LENGTH

REF. XXX = METERS  
EXAMPLE 010- 1M

- NOTES:
1. MATERIAL: SEE TABLE
  2. FINISHES: SEE TABLE
  3. PRODUCT SPECIFICATIONS: PS-120614-001
  4. CONTROL DOC: ES-120614-001
  5. 3 & 4 POLE ELECTRICAL SPECIFICATIONS:  
VOLTAGE RATING: 125V  
CURRENT RATING: 4 AMPS
  6. 5 POLE ELECTRICAL SPECIFICATIONS:  
VOLTAGE RATING: 32V  
CURRENT RATING: 4 AMPS

MALE FACE VIEW

3 POLE	4 POLE	5 POLE
1 BROWN 3 BLUE 4 BLACK	1 BROWN 2 WHITE 3 BLUE 4 BLACK	1 BROWN 2 WHITE 3 BLUE 4 BLACK 5 GRAY

ITEM	QTY.	DESCRIPTION	MATERIAL	FINISH
8	1	WRAP LABEL	PLASTIC FILM	BLACK/YELLOW
7	1	FLAG LABEL (WARNING)	POLYESTER	BLACK/ORANGE
6	1	OVERMOLD	TPE	YELLOW
5	1	OUTER SLEEVE	ST. STEEL	PASSIVATED
4	1	INNER SLEEVE	ST. STEEL	PASSIVATED
3	XX	CONTACT	Cu ALLOY	GOLD PLATED
2	1	INSERT	PUR	BLACK
1	1	CABLE, #18 AWG SJ00W	NEOPRENE	YELLOW

<b>ADDED P/N LEGEND</b> EC NO: IPG2014-0138 DRAWNRSTONE 2013/07/23 CHKD: B WOODMAN 2013/08/01 APPR: B WOODMAN 2013/12/30	<b>QUALITY SYMBOLS</b> ▽=0 ▽=0	<b>GENERAL TOLERANCES (UNLESS SPECIFIED)</b>		<b>DIMENSION STYLE</b> IN/MM	<b>SCALE</b> 1.5:1	<b>DESIGN UNITS</b> INCH	THIRD ANGLE PROJECTION		
		4 PLACES ± --- ± --- 3 PLACES ± --- ± --- 2 PLACES ± --- ± .01 1 PLACE ± 0.3 ± ---	mm INCH	DRAWN BY RSTONE 2011/11/21	DATE 2011/11/21	<b>ULTRA-LOCK ZONE 2 MALE, STRAIGHT C02, 18 AWG, SJ00W</b>			
		ANGULAR ± 2 °		CHECKED BY L. HARTMANN 2012/01/27	DATE 2012/01/27	<b>MOLEX INCORPORATED</b>			
		DRAFT WHERE APPLICABLE MUST REMAIN WITHIN DIMENSIONS		APPROVED BY JFMURPHY 2012/04/18	DATE 2012/04/18	MATERIAL NO. <b>SEE CHART</b>	DOCUMENT NO. <b>SD-120614-017</b>	SHEET NO. 1 OF 1	

THIS DRAWING CONTAINS INFORMATION THAT IS PROPRIETARY TO MOLEX INCORPORATED AND SHOULD NOT BE USED WITHOUT WRITTEN PERMISSION

DRAWING NO.	DESCRIPTION	FINISHED GOOD REV. LEVEL
LWR000A18	MIC U-LOCK ZONE 2 RECEPT ASSY, FEM. 1/2 NPT, 22 AWG	C
LWR006A18	MIC U-LOCK ZONE 2 RECEPT ASSY, MALE 1/2 NPT, 22 AWG	B
LWRA00A18	MIC U-LOCK ZONE 2 RECEPT ASSY, FEM. 1/4 NPT, 22 AWG	C
LWRA06A18	MIC U-LOCK ZONE 2 RECEPT ASSY, MALE 1/4 NPT, 22 AWG	B
LWR000A16	MIC U-LOCK ZONE 2 RECEPT ASSY, FEM. 1/2 NPT, 18 AWG	B
LWR006A16	MIC U-LOCK ZONE 2 RECEPT ASSY, MALE 1/2 NPT, 18 AWG	B
LWXXXXXC02XXXX	U-LOCK ZONE 2 C02 CORD ASSY, 18AWG SJ00W, DC COLOR	C
LWXXXXXK03XXXX	U-LOCK ZONE 2 K03 CORD ASSY, 18AWG TPE, DC COLOR	C
LWXXXXXK05XXXX	U-LOCK ZONE 2 K05 CORD ASSY, 22AWG TPE, DC COLOR	C
SD-120614-999	CONTROL DOC FOR ULTRA-LOCK ZONE 2	D

PRELIMINARY EC NO: IPG2016-0500 DRAWN: RSTONE 2016/03/07 CHKD: WAI LEUNG 2016/05/20 APPR: JFMURPHY 2016/05/20	QUALITY SYMBOLS	GENERAL TOLERANCES (UNLESS SPECIFIED)		DIMENSION STYLE IN/MM		SCALE 1:1	DESIGN UNITS INCH	THIRD ANGLE PROJECTION	
	▽=0	4 PLACES	± ---	± ---	DRAWN BY RSTONE	DATE 2016/03/07	TITLE SCHEDULE DRAWING FOR ULTRA LOCK ZONE 2		
	∇=0	3 PLACES	± ---	± ---	CHECKED BY WAI LEUNG	DATE			
		2 PLACES	± ---	± ---	APPROVED BY JFMURPHY	DATE 2016/05/20	 DOCUMENT NO. SD-120614-998		
		1 PLACE	± ---	± ---	MATERIAL NO.	-			
	0 PLACE	± ---	± ---	ANGULAR ± ---°		THIS DRAWING CONTAINS INFORMATION THAT IS PROPRIETARY TO MOLEX INCORPORATED AND SHOULD NOT BE USED WITHOUT WRITTEN PERMISSION			

CLASS 1, DIVISION 2, GROUP A, B, C, OR D  
HAZARDOUS LOCATION

NON-HAZARDOUS LOCATION

CLASS 1, DIVISION 2, GROUP A, B, C, OR D  
HAZARDOUS LOCATION

NON-HAZARDOUS LOCATION

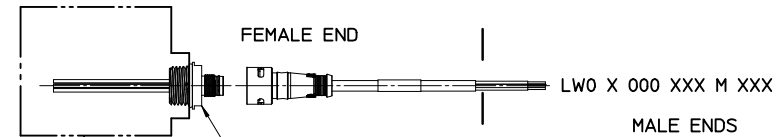

LWR X 006 A18 CXXX  
(MALE 1/2" NPT)  
LWR X A06 A18 CXXX  
(MALE 1/4" NPT)

LW0 X 000 XXX M XXX

MALE ENDS

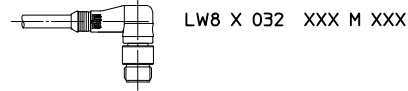

LW8 X 032 XXX M XXX

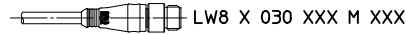

LW8 X 030 XXX M XXX

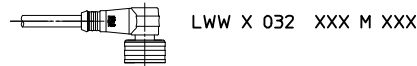

LWW X 032 XXX M XXX



LWW X 030 XXX M XXX

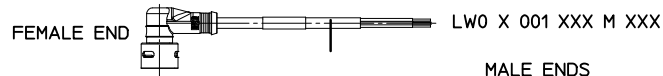

LW0 X 001 XXX M XXX

MALE ENDS

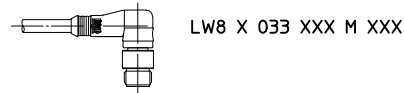

LW8 X 033 XXX M XXX

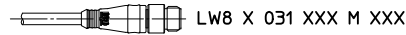

LW8 X 031 XXX M XXX

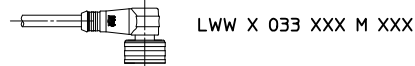

LWW X 033 XXX M XXX

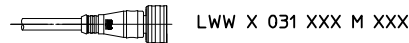

LWW X 031 XXX M XXX

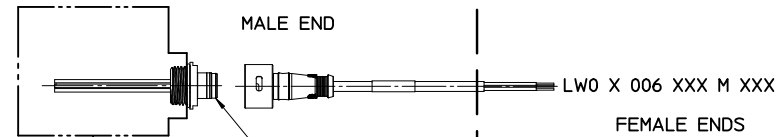

LWR X 000 A18 CXXX  
(FEMALE 1/2" NPT)  
LWR X A00 A18 CXXX  
(FEMALE 1/4" NPT)

LW0 X 006 XXX M XXX

FEMALE ENDS

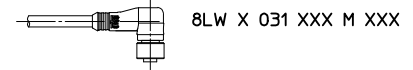

8LW X 031 XXX M XXX

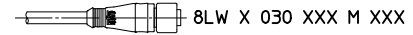

8LW X 030 XXX M XXX



WLW X 031 XXX M XXX

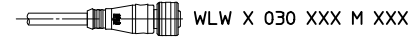

WLW X 030 XXX M XXX

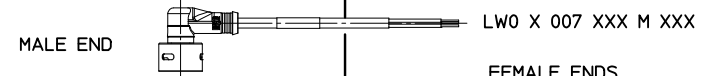

LW0 X 007 XXX M XXX

FEMALE ENDS

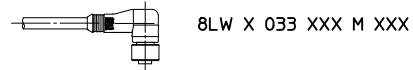

8LW X 033 XXX M XXX

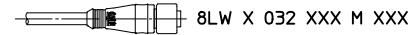

8LW X 032 XXX M XXX

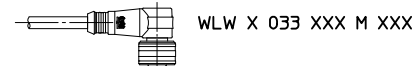

WLW X 033 XXX M XXX



WLW X 032 XXX M XXX

NOTICE: THIS PART IS CSA AND FACTORY MUTUAL APPROVED  
NO CHANGES CAN BE MADE TO THE ASSEMBLY, COMPONENTS  
OR SUPPLIER WITHOUT PRIOR APPROVAL FROM CSA AND  
FACTORY MUTUAL.

- NOTES:
1. THE INSTALLATION MUST BE IN ACCORDANCE WITH THE NATIONAL ELECTRICAL CODE (NEC), ANSI/NFPA 70. SPECIFIC REQUIREMENTS FOR THE INSTALLATION OF ITC RATED CABLE MAY BE FOUND IN ARTICLE 501.4(B)(1)(5) AND ARTICLE 727.4
  2. THE MOLDED CONSTRUCTION OF THE CORDSET AND GAS/VAPORTIGHT CONTINUOUS SHEATH OF THE CABLE MEET THE REQUIREMENTS OF THE NEC, ARTICLE 501-5(E)(2) FOR CABLE SEALS IN CLASS 1, DIVISION 2
- ⚠ FIELD DEVICE APPROVAL FOR CLASS 1, DIV. 2 OR CLASS 1, ZONE2 INSTALLATIONS
4. ATEX cert no: ATEX FM15ATEX0048X IECEx FMG 15.0012X Ⓢ

REF. SEE SHEET 3 FOR CONFIGURATION INFORMATION

THIS DRAWING SUPERSEDES ES-120614-001 REV-B

ADDED NOTE 4 EC NO: IPG2016-0500 DRAWNRSTONE 2015/10/16 CHKD:WAI LEUNG 2016/05/20 APPR:JFMURPHY 2016/05/20 REV D	QUALITY SYMBOLS ▽=0 ▽=0	GENERAL TOLERANCES (UNLESS SPECIFIED)		DIMENSION STYLE IN/MM		SCALE 1:1	DESIGN UNITS INCH	THIRD ANGLE PROJECTION		
				DRAWN BY RSTONE		DATE 2012/05/18		TITLE <b>CONTROL DOC FOR ULTRA-LOCK ZONE 2</b>		
				CHECKED BY K JOZWIK		DATE 2012/05/22				
				APPROVED BY JFMURPHY		DATE 2012/08/27		MATERIAL NO. <b>1206149999</b>		
		DRAFT WHERE APPLICABLE MUST REMAIN WITHIN DIMENSIONS		DOCUMENT NO. SD-120614-999		SHEET NO. 1 OF 3		THIS DRAWING CONTAINS INFORMATION THAT IS PROPRIETARY TO MOLEX INCORPORATED AND SHOULD NOT BE USED WITHOUT WRITTEN PERMISSION		

CLASS 1, DIVISION 2, GROUP A, B, C, OR D  
HAZARDOUS LOCATION

HAZARDOUS LOCATION

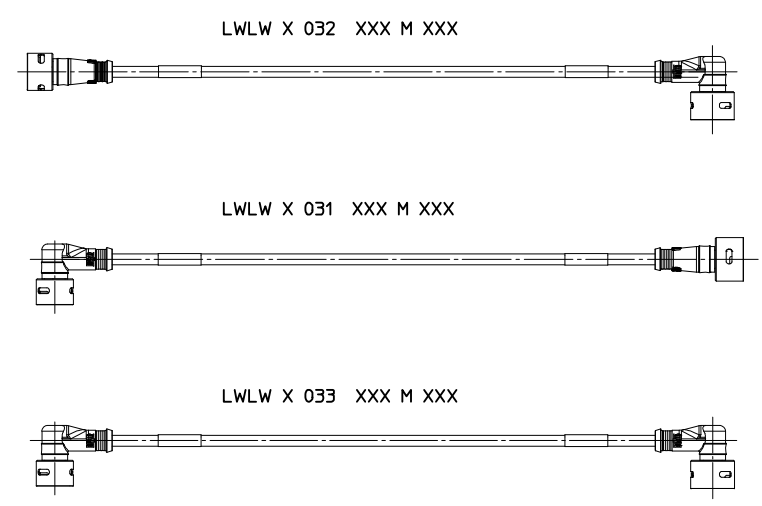
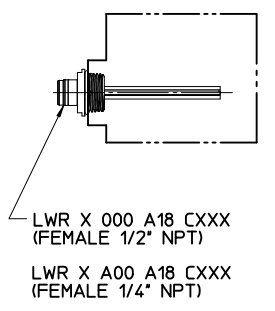
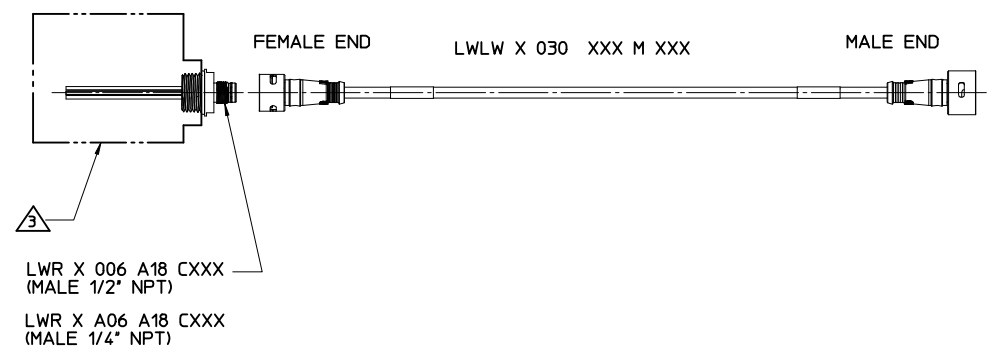

- REF:
1. SEE SHEET 1 FOR NOTES
  2. SEE SHEET 3 FOR CONFIGURATION INFORMATION

NOTICE: THIS PART IS CSA AND FACTORY MUTUAL APPROVED  
NO CHANGES CAN BE MADE TO THE ASSEMBLY, COMPONENTS  
OR SUPPLIER WITHOUT PRIOR APPROVAL FROM CSA AND  
FACTORY MUTUAL.

SEE SHEET 1 EC NO: JFG2016-0500 DRAWNRSTONE 2015/10/16 CHKD:WAI LEUNG 2016/05/20 APPR:JFMURPHY 2016/05/20	QUALITY SYMBOLS ▽=0 ▽=0	GENERAL TOLERANCES (UNLESS SPECIFIED)		DIMENSION STYLE IN/MM	SCALE 1:1	DESIGN UNITS INCH	THIRD ANGLE PROJECTION		
		4 PLACES ± --- ± ---	3 PLACES ± --- ± ---	2 PLACES ± --- ± ---	1 PLACE ± --- ± ---	DRAWN BY RSTONE	DATE 2012/05/18	TITLE CONTROL DOC FOR ULTRA-LOCK ZONE 2	
		ANGULAR ± ---°				CHECKED BY K JOZWIK	DATE 2012/05/22		
		DRAFT WHERE APPLICABLE MUST REMAIN WITHIN DIMENSIONS				APPROVED BY JFMURPHY	DATE 2012/08/27	MATERIAL NO. 1206149999	DOCUMENT NO. SD-120614-999

THIS DRAWING CONTAINS INFORMATION THAT IS PROPRIETARY TO MOLEX INCORPORATED AND SHOULD NOT BE USED WITHOUT WRITTEN PERMISSION

M12/MICROCHANGE ULTRA-LOCK CORD CONNECTORS AND CORD SETS

LWO 3 000 C02 M 020 8  
 I II III IV V VI VII

I: CONNECTOR TYPE  
 LWO= ULTRA-LOCK ZONE 2 MALE OR FEMALE SINGLE END CORDSET  
 LWW= ULTRA-LOCK ZONE 2 FEMALE TO STANDARD ULTRA-LOCK MALE DOUBLE ENDED CORDSET  
 WLW= ULTRA-LOCK ZONE 2 MALE TO STANDARD ULTRA-LOCK FEMALE DOUBLE ENDED CORDSET  
 LW8= ULTRA-LOCK ZONE 2 FEMALE TO STANDARD M12 MALE DOUBLE ENDED CORDSET  
 8LW= ULTRA-LOCK ZONE 2 MALE TO STANDARD M12 FEMALE DOUBLE ENDED CORDSET  
 LWLW= ULTRA-LOCK ZONE 2 FEMALE TO ULTRA-LOCK ZONE 2 MALE DOUBLE ENDED CORDSET

II: NUMBER OF POLES: 3= 3 PIN, 4= 4 PIN, 5 = 5 PIN

III: CONFIGURATION  
 SINGLE ENDED:  
 000= STRAIGHT FEMALE CONNECTOR  
 001= FEMALE 90°  
 006= STRAIGHT MALE, EXTERNAL THREAD  
 007= MALE 90°

DOUBLE ENDED:  
 030= STRAIGHT FEMALE CONNECTOR TO STRAIGHT MALE CONNECTOR  
 031= FEMALE 90° TO MALE STRAIGHT  
 032= FEMALE STRAIGHT TO MALE 90°  
 033= FEMALE 90° TO MALE 90°

IV: CABLE TYPE  
 C02= SJ00W YELLOW, 18 AWG, DC CODE  
 K03= PLTC/ITC, 18 AWG, TPE JACKET  
 K05= PLTC/ITC, 22 AWG, TPE JACKET

V: UNIT OF MEASURE  
 F= FEET  
 M= METERS

VI: CABLE LENGTH (MAY BE ANY 3 DIGIT NUMBER FROM 001-100)  
 1ST DIGIT= 10 X LENGTH  
 2ND DIGIT= 1 X LENGTH  
 3RD DIGIT= .1 X LENGTH

VII: COUPLING NUT MATERIAL  
 ULTRA-LOCK ZONE 2 END(S) ARE STAINLESS STEEL

M12 OR ULTRA-LOCK:  
 NONE = STANDARD MATERIAL (NICKEL PLATED BRASS)  
 8= STAINLESS STEEL

**NOTICE: THIS PART IS CSA AND FACTORY MUTUAL APPROVED  
 NO CHANGES CAN BE MADE TO THE ASSEMBLY, COMPONENTS  
 OR SUPPLIER WITHOUT PRIOR APPROVAL FROM CSA AND  
 FACTORY MUTUAL.**

M12/MICROCHANGE ULTRA-LOCK OUTLETS

LWR 3 A00 A18 M 020 8  
 I II III IV V VI VII

I: CONNECTOR TYPE  
 LWR= LOCKING INLETS AND OUTLETS

II: NUMBER OF POLES 3=3 PIN, 4= 4 PIN, & 5= 5 PIN

III: CONFIGURATION  
 SINGLE ENDED:  
 A00= FEMALE STRAIGHT (INT.THEAD) 1/4-18 NPT  
 A06= MALE STRAIGHT (EXT.THEAD) 1/4-18 NPT  
 000= FEMALE STRAIGHT (INT.THEAD) 1/2-14 NPT  
 006= MALE STRAIGHT (EXT.THEAD) 1/2-14 NPT

IV: WIRE TYPE  
 A18= 22 AWG, PVC, DC COLOR CODE, UL TYPE 1061  
 A16= 18 AWG, PVC, DC COLOR CODE, UL TYPE 1569  
 000= PCB PINS  
 000= PCB PINS

V: UNIT OF MEASURE  
 A= INCHES  
 F= FEET  
 C= CENTIMETERS  
 M= METERS

VI: WIRE LENGTH (MAY BE ANY 3 DIGIT NUMBER FROM 001-100)  
 1ST DIGIT= 10 X LENGTH  
 2ND DIGIT= 1 X LENGTH  
 3RD DIGIT= .1 X LENGTH

VII: SHELL MATERIAL  
 M12 OR ULTRA-LOCK:  
 NONE = STANDARD MATERIAL (COPPER ZINC ALLOY)  
 3= NICKEL PLATED BRASS  
 8= STAINLESS STEEL

SEE SHEET 1 EC NO: IFC2016-0500 DR: DR: W/HRSTONE 2015/10/16 CHK: CHK: WAI LEUNG 2016/05/20 APPR: APPR: JF MURPHY 2016/05/20	QUALITY SYMBOLS	GENERAL TOLERANCES (UNLESS SPECIFIED)	DIMENSION STYLE	SCALE	DESIGN UNITS	THIRD ANGLE PROJECTION
	▽=0 ▽=0	mm	IN/MM	1:1	INCH	CONTROL DOC FOR ULTRA-LOCK ZONE 2
		INCH	IN/MM			
	DESCRIPTION	4 PLACES ±--- ±--- 3 PLACES ±--- ±--- 2 PLACES ±--- ±--- 1 PLACE ±--- ±--- ANGULAR ±---°	DRAWN BY DATE RSTONE 2012/05/18 CHECKED BY DATE K JOZWIK 2012/05/22 APPROVED BY DATE JFMURPHY 2012/08/27	TITLE MOLEX INCORPORATED		
REV	DRAFT WHERE APPLICABLE MUST REMAIN WITHIN DIMENSIONS	MATERIAL NO. 1206149999	DOCUMENT NO. SD-120614-999	SHEET NO. 3 OF 3		