

# Distinctive Characteristics

Top or side actuation permits flexible board design.

Bright, LED illumination at tip of actuator.

Compact dimensions and low profile allow high density mounting and close stacking of PC boards.

Crisp actuation positively indicates circuit status.

Double molded thermoset base and thermoplastic housing prevent loosening of terminals due to high soldering temperatures.

Sliding twin contact mechanism with self-cleaning action provides smooth actuation and produces high contact reliability.

Insert molded terminals lock out flux, solvents, and other contaminants.

Inch terminal spacing for standard PC board grid (.100" x .100").

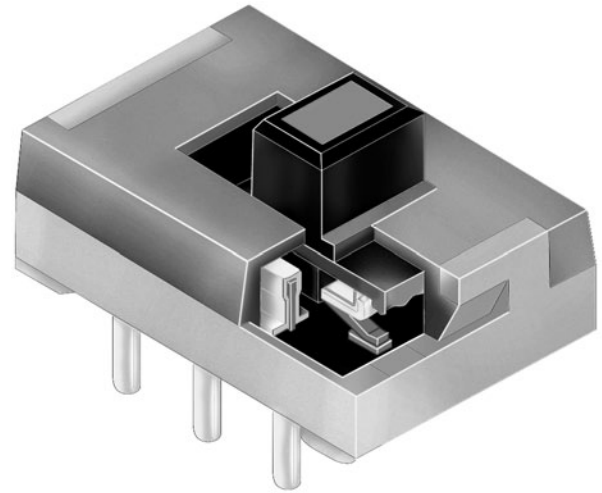

Actual Size



# General Specifications

## Electrical Capacity (Resistive Load)

**Power Level:** 0.1A @ 30V DC

## Other Ratings

<b>Contact Resistance:</b>	20 milliohms maximum
<b>Insulation Resistance:</b>	100 megohms minimum @ 500V DC
<b>Dielectric Strength:</b>	500V AC minimum 1 minute minimum
<b>Mechanical Life:</b>	10,000 operations minimum
<b>Electrical Life:</b>	10,000 operations minimum
<b>Contact Timing:</b>	Shorting (make-before-break)
<b>Total Travel:</b>	.079" (2.0mm)

## Materials & Finishes

<b>Actuator:</b>	Polyacetal
<b>Upper Case:</b>	Polyacetal
<b>Lower Case:</b>	Glass fiber reinforced polyester
<b>Movable Contactor:</b>	Phosphor bronze with silver plating
<b>Interior Base:</b>	Phenolic resin (thermoset)
<b>Terminals:</b>	Brass with silver plating over copper plating

## Environmental Data

<b>Operating Temp Range:</b>	-15°C through +60°C (+5°F through +140°F)
<b>Humidity:</b>	90 ~ 95% humidity for 96 hours @ 40°C (104°F)
<b>Vibration:</b>	10 ~ 55Hz with peak-to-peak amplitude of 1.5mm traversing the frequency range & returning in 1 minute; 3 right angled directions for 2 hours
<b>Shock:</b>	50G (490m/s <sup>2</sup> ) acceleration (tested in 6 right angled directions, with 5 shocks in each direction)

## PCB Processing

<b>Soldering:</b>	Wave Soldering: For non-supported through-hole, see Profile B in Supplement section. For supported through-hole, 5 seconds maximum @ 250°C maximum. Manual Soldering: See Profile B in Supplement section.
<b>Cleaning:</b>	These devices are not process sealed. Hand clean locally using alcohol based solution.

## Standards & Certifications

The SS series devices have not been tested for UL recognition and CSA certification. These switches are designed for use in a low-voltage, low-current circuit. When used as intended in a low-voltage, low-current circuit, the results do not produce hazardous energy.

## TYPICAL SWITCH ORDERING EXAMPLE



### DESCRIPTION FOR TYPICAL ORDERING EXAMPLE

#### SS12SDP2LC



### POLES & CIRCUITS

Pole	Model	Slide Position			Connected Terminals			Throw & Schematics
		Right	Center	Left	Right	Center	Left	
SP	SS12S	ON	NONE	ON	2-1	NONE	2-3	SPDT
DP	SS22S	ON	NONE	ON	2-1 5-4	NONE	2-3 5-6	DPDT

Note: Terminal numbers are not actually on switch. Isolated LED circuit requires external power source.

### TERMINAL SPACING

**D** Inch .100" x .100"

Single Pole Models



Double Pole Models

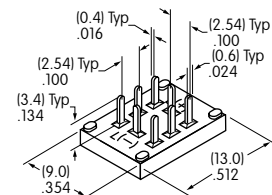

## CONTACT MATERIALS & RATINGS

2

Silver over Phosphor Bronze

Power Level

0.1A @ 30V DC

## TYPICAL SWITCH DIMENSIONS

### Single & Double Pole

### Top Actuated

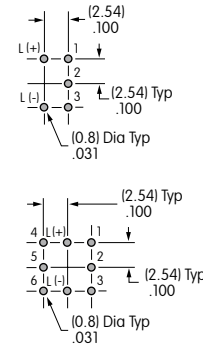
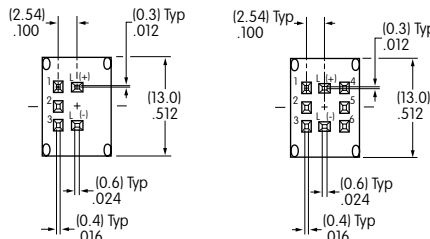
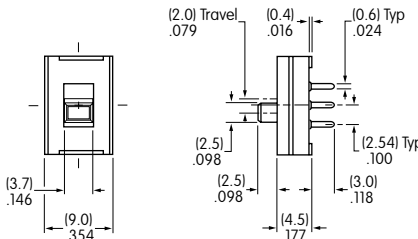

SS22SDP2LC

### Single & Double Pole

### Side Actuated

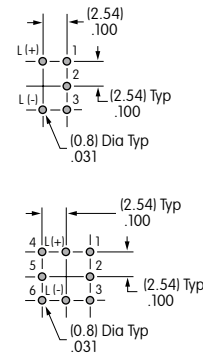
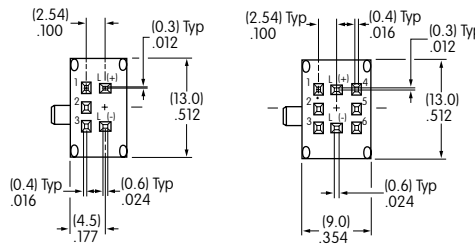
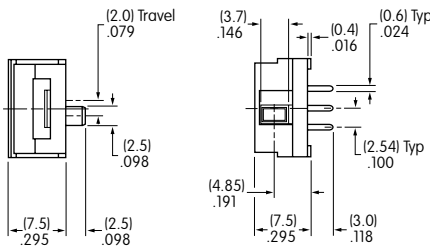

SS12SDH2LC

## LED COLORS & SPECIFICATIONS

LEDs are supplied as an integral part of the switch (not available separately). The lamp circuit is independent of switch operation. Electrical specifications shown are determined at a basic temperature of 25°C. If the source voltage exceeds the rated voltage, a ballast resistor is required. The resistor value can be calculated by using the formula given in the Supplement.

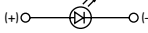
<div style="border: 1px solid black; padding: 2px;">L</div> <b>Isolated, 1-element</b> 	Color	<div style="border: 1px solid black; padding: 2px;">C</div> Red	<div style="border: 1px solid black; padding: 2px;">E</div> Yellow	<div style="border: 1px solid black; padding: 2px;">F</div> Green
	Forward Peak Current	$I_{FM}$	30mA	30mA
Typical Forward Current	$I_F$	16mA	16mA	16mA
Forward Voltage	$V_F$	1.98V	2.06V	2.16V
Reverse Peak Voltage	$V_{RM}$	5V	5V	5V
Current Reduction Rate Above 25°C	$\Delta I_F$	0.40mA/°C	0.42mA/°C	0.33mA/°C
Ambient Temperature Range		-15° ~ +60°C		

## OPTIONAL CAP

### AT4065 Slide Cap

Material: Polycarbonate

Cap can be assembled on request

Cap Color: Black only

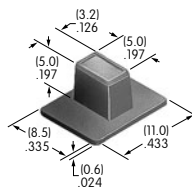

Window color should match LED color.

Colors Available:

C Red    E Yellow    F Green

Toggles  
 Rockers  
 Pushbuttons  
 Illuminated PB  
 Programmable  
 Keylocks  
 Rotaries  
 Slides  
 Tactiles  
 Tilt  
 Touch  
 Indicators  
 Accessories  
 Supplement