

## Overview

The KEMET SS Coils, SS21V Type AC line filters are offered in a wide variety of sizes and specifications.

- Wide variety of sizes and specifications

- DC Resistances as low as 0.07  $\Omega$

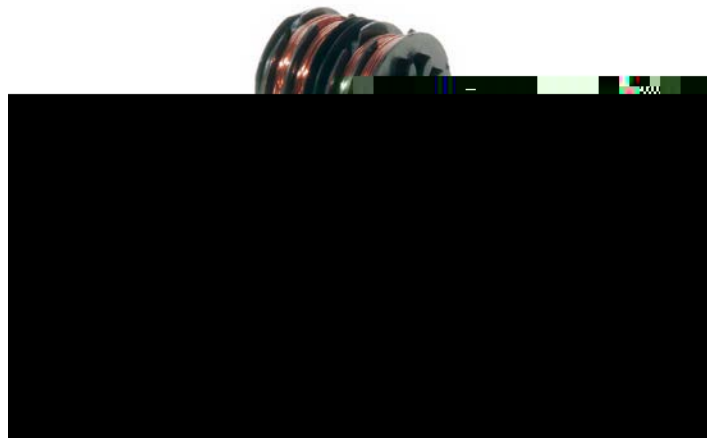

SS			R	03	

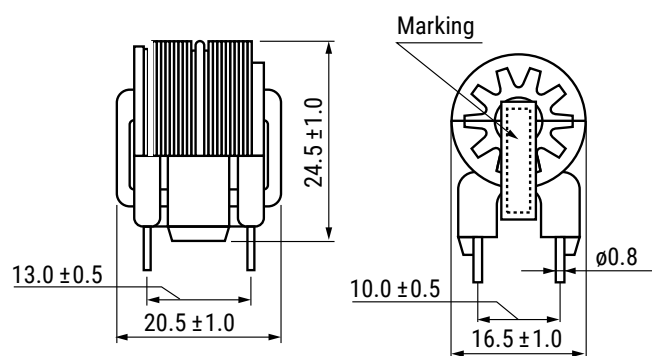

---

	> 100 MΩ at 500 VDC (between lines)
	-25°C to T (T = 120 - temperature rise)

---

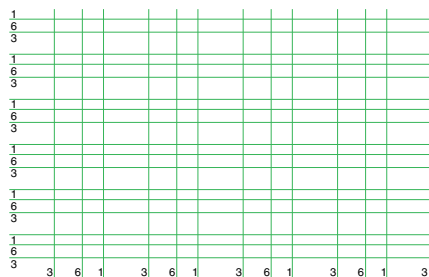
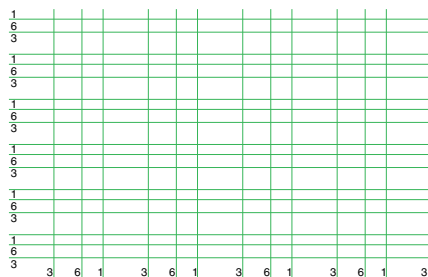
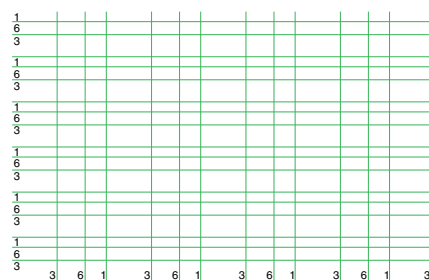
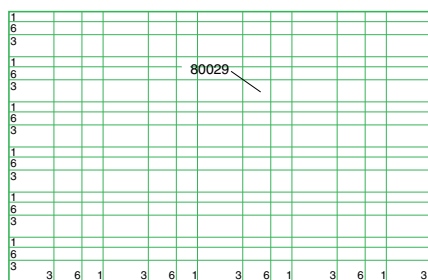
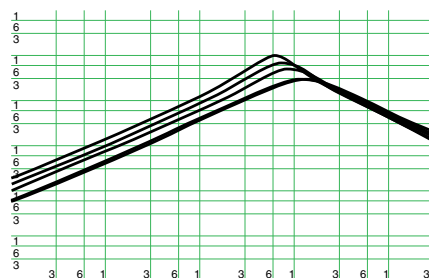
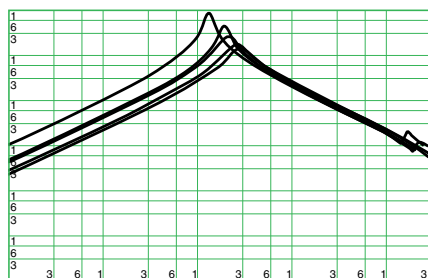

Use within 6 months. If the product is used after a storage period of 6 months or longer, confirm its solderability

Avoid storage near strong magnetic field, as such condition may magnetize the product.

For a complete list of our global sales offices, please visit [www.kemet.com/sales](http://www.kemet.com/sales).

---

All product specifications, statements, information and data (collectively, the "Information") in this datasheet are subject to change. The customer is responsible for

---