

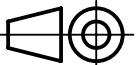

arrangement of pins and bushes see page 2 and 3

 All Dimensions in mm Original Size DIN A4		Scale 2:1	Free size tol.		Ref.
 All rights reserved Department EL PD - DE		Created by HELLMANN	Inspected by RIEPE	Standardisation RUETERA	Date 2018-01-11
HARTING Electric GmbH & Co. KG D-32339 Espelkamp		Title guide bush/pin			State Final Release
09 33 000 9809	guide bush	Type TB			Doc-Key / ECM-Nr. 100208457/UGD/003/C 500000129848
09 33 000 9808	guide pin	Number 09 33 000 980X			Rev. C
Part No	description				Page 1/3

1 2 3 4 5 6

# coding system with guide pins and bushes

for hoods/housings with one frame or hinged frame

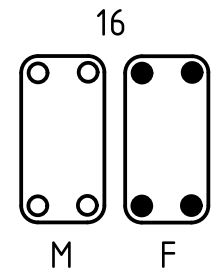
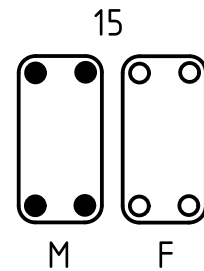
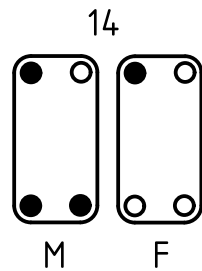
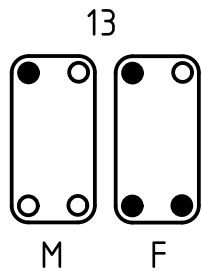
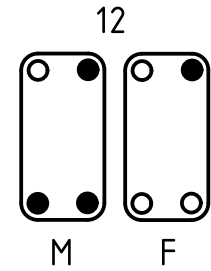
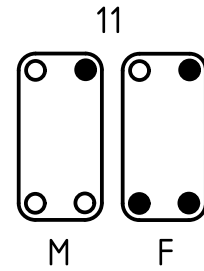
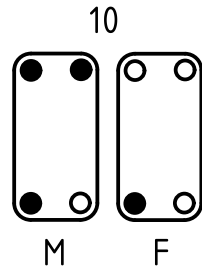
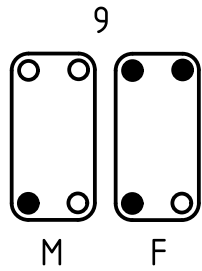
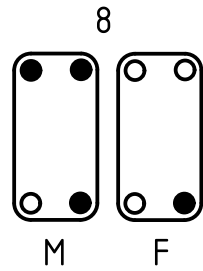
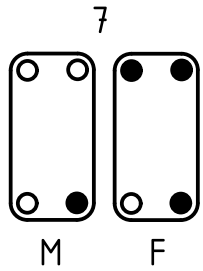
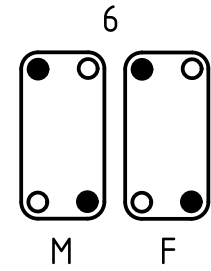
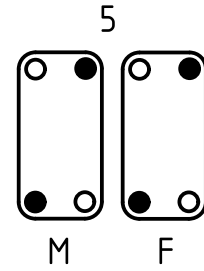
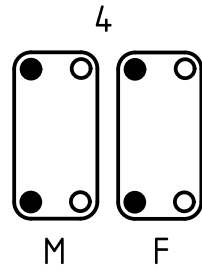
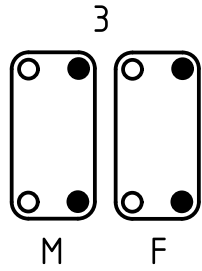
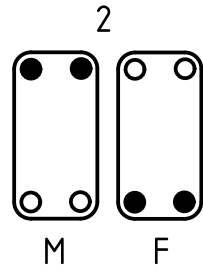
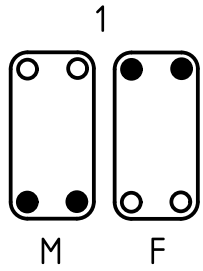

- F - frame or hinged frame for hoods
- M - frame or hinged frame for housings
- - guide pin
- - guide bush

	All rights reserved	Created by HELLMANN	Inspected by RIEPE	Standardisation RUETERA	Date 2018-01-11	State Final Release	
	Department EL PD - DE	Title guide bush/pin				Doc-Key / ECM-Nr. 100208457/UGD/003/C 500000129848	
HARTING Electric GmbH & Co. KG D-32339 Espelkamp		Type TB	Number 09 33 000 980X			Rev. C	Page 2/3

# coding system with code pins

for hoods/housings with two frame or two hinged frame

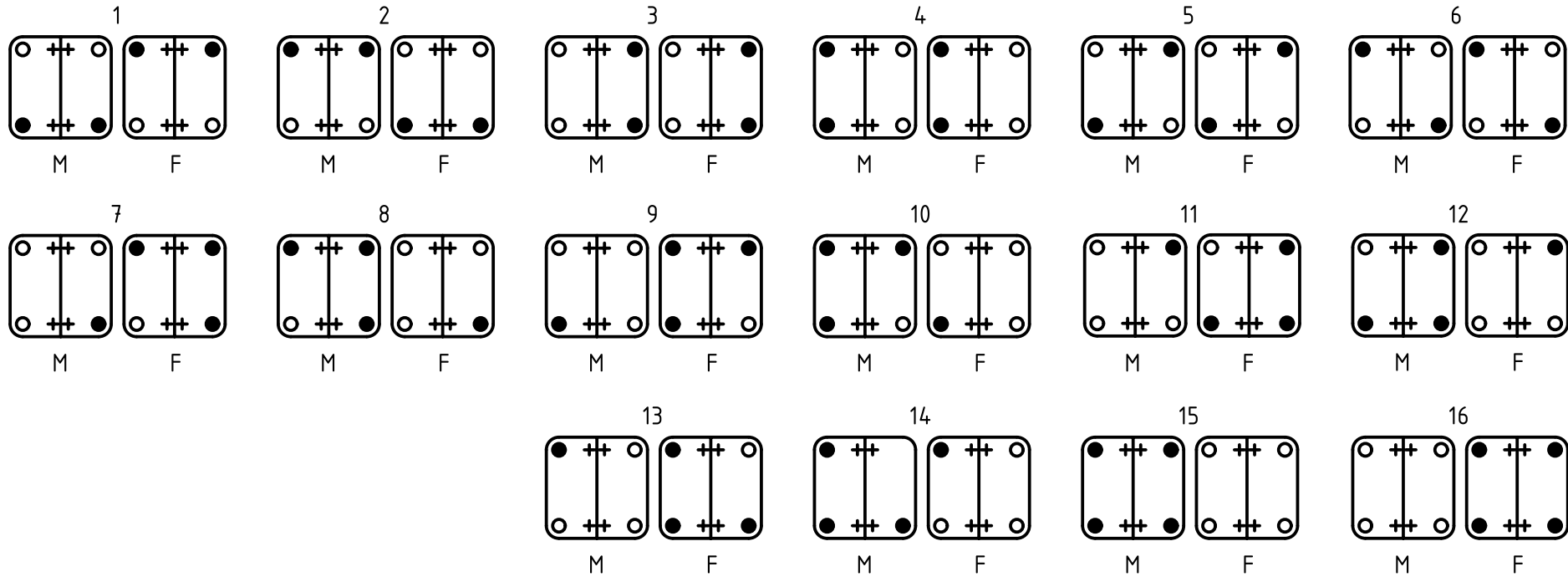

- F - frame or hinged frame for hoods
- M - frame or hinged frame for housings
- - guide pin
- - guide bush
- + - mounting screw

	All rights reserved	Created by HELLMANN	Inspected by RIEPE	Standardisation RUETERA	Date 2018-01-11	State Final Release	
	Department EL PD - DE	Title guide bush/pin				Doc-Key / ECM-Nr. 100208457/UGD/003/C 500000129848	
HARTING Electric GmbH & Co. KG D-32339 Espelkamp		Type TB	Number 09 33 000 980X			Rev. C	Page 3/3