

CMOS LDO Regulators for Portable Equipments

1ch 200mA

CMOS LDO Regulators



BU□□TA2WNVX series, BU□□TA2WHFV series

No.11020ECT01

●Description

BU□□TA2WNVX /HFV series is high-performance FULL CMOS regulator with 200-mA output, which is mounted on microminiature package SSON004X1216 (1.2 mm × 1.6 mm × 0.6 mm) & HVSO5 (1.6mm × 1.6mm × 0.6mm). It has excellent noise characteristics and load responsiveness characteristics despite its low circuit current consumption of 40 μA. It is most appropriate for various applications such as power supplies for logic IC, RF, and camera modules. Microminiature package SSON004X1216 & HVSO5 with built-in heatsink is adopted for the package, which contributes to the space-saving design of the set.

●Features

- 1) High-accuracy output voltage of ±1% (±25 mV on 1.5-V & 1.8-V products)
- 2) High ripple rejection: 70 dB (Typ., 1 kHz, VOUT≤1.8 V)
- 3) Compatible with small ceramic capacitor (CIN=Co=1.0 μF)
- 4) Low current consumption: 40 μA
- 5) ON/OFF control of output voltage
- 6) With built-in overcurrent protection circuit and overheat protection circuit
- 7) With built-in output discharge circuit
- 8) Adopting microminiature power package SSON004X1216

●Applications

Battery-powered portable equipment, etc.

●Line up

■ 200 mA BU□□TA2WNVX / HFV series

Product Name	1.5	1.8	2.5	2.6	2.7	2.8	2.85	2.9	3.0	3.1	3.2	3.3	3.4	Package
BU□□TA2WNVX	○	○	○	○	○	○	○	○	○	○	○	○	○	SSON004X1216
BU□□TA2WHFV	○	○	○	○	○	○	○	○	○	○	○	○	○	HVSO5

 Model name: BH□□TA2W□□□
 a b

Symbol	Contents					
a	Specification of output voltage					
	□□	Output voltage (V)	□□	Output voltage (V)	□□	Output voltage (V)
	15	1.5V(Typ.)	28	2.8V(Typ.)	32	3.2V(Typ.)
	18	1.8V(Typ.)	2J	2.85V(Typ.)	33	3.3V(Typ.)
	25	2.5V(Typ.)	29	2.9V(Typ.)	34	3.4V(Typ.)
	26	2.6V(Typ.)	30	3.0V(Typ.)	-	-
	27	2.7V(Typ.)	31	3.1V(Typ.)	-	-
b	Package	NVX :SSON004X1216 HFV :HVSO5				

●Absolute maximum rating

Parameter	Symbol	Ratings	Unit
Maximum applied power voltage	VMAX	-0.3 ~ +6.5	V
Power dissipation	Pd1	220* ¹ (SSON004X1216)	mW
	Pd2	410* ² (HVSOF5)	
Maximum junction temperature	TjMAX	+125	°C
Operational temperature range	Topr	-40 ~ +85	°C
Storage temperature range	Tstg	-55 ~ +125	°C

*1 When 1 PCB (70 mm × 70 mm, thickness 1.6-mm glass epoxy) a standard ROHM board is implemented.
Reduced to 2.2 mW/°C when used at Ta=25°C or higher.

*2 When 1 PCB (70 mm × 70 mm, thickness 1.6-mm glass epoxy) a standard ROHM board is implemented.
Reduced to 4.1 mW/°C when used at Ta=25°C or higher.

●Recommended operating range (Do not exceed Pd.)

Parameter	Symbol	Ratings	Unit
Input power supply voltage	VIN	2.5 ~ 5.5	V
Maximum output current	IMAX	200	mA

●Recommended operating conditions

Parameter	Symbol	Ratings			Unit	Conditions
		Min.	Typ.	Max.		
Input capacitor	CIN	0.5* ³	1.0	—	μF	A ceramic capacitor is recommended.
Output capacitor	CO	0.5* ³	1.0	—	μF	A ceramic capacitor is recommended.

*3 Set the capacity value of the capacitor so that it does not fall below the minimum value, taking temperature characteristics, DC device characteristics, and change with time into consideration.

●Electrical characteristics

(Unless otherwise specified $T_a=25^{\circ}\text{C}$, $V_{\text{IN}}=V_{\text{OUT}}+1.0\text{ V}$ ($V_{\text{IN}}=3.5\text{ V}$ on $V_{\text{OUT}}=1.8\text{-V}$ and 1.5-V products),
 $\text{STBY}=1.5\text{ V}$, $C_{\text{IN}}=1.0\text{ }\mu\text{F}$, $C_{\text{O}}=1.0\text{ }\mu\text{F}$)

Parameter	Symbol	Limits			Unit	Conditions	
		Min.	Typ.	Max.			
Output voltage	VOUT	$V_{\text{OUT}} \times 0.99$	VOUT	$V_{\text{OUT}} \times 1.01$	V	$I_{\text{OUT}}=10\text{ }\mu\text{A}$, $V_{\text{OUT}} \geq 2.5\text{ V}$	
		$V_{\text{OUT}} - 25\text{ mV}$		$V_{\text{OUT}} + 25\text{ mV}$		$I_{\text{OUT}}=10\text{ }\mu\text{A}$, $V_{\text{OUT}} < 2.5\text{ V}$	
Circuit current	IIN	-	40	95	μA	$I_{\text{OUT}}=0\text{ mA}$	
Circuit current (at STBY)	ISTBY	-	-	1	μA	STBY=0 V	
Ripple rejection	RR	55	70	-	dB	VRR=-20 dBv, fRR=1 kHz, $I_{\text{OUT}}=10\text{ mA}$, $1.5\text{ V} \leq V_{\text{OUT}} \leq 1.8\text{ V}$	
			65			VRR=-20 dBv, fRR=1 kHz, $I_{\text{OUT}}=10\text{ mA}$, $2.5\text{ V} \leq V_{\text{OUT}}$	
Input/Output voltage difference	VSAT	-	400	800	mV	$2.5\text{ V} \leq V_{\text{OUT}} \leq 2.6\text{ V}$ ($V_{\text{IN}}=0.98 \times V_{\text{OUT}}$, $I_{\text{OUT}}=200\text{ mA}$)	
		-	360	720	mV	$2.7\text{ V} \leq V_{\text{OUT}} \leq 2.85\text{ V}$ ($V_{\text{IN}}=0.98 \times V_{\text{OUT}}$, $I_{\text{OUT}}=200\text{ mA}$)	
		-	330	660	mV	$2.9\text{ V} \leq V_{\text{OUT}} \leq 3.1\text{ V}$ ($V_{\text{IN}}=0.98 \times V_{\text{OUT}}$, $I_{\text{OUT}}=200\text{ mA}$)	
		-	300	600	mV	$3.2\text{ V} \leq V_{\text{OUT}} \leq 3.4\text{ V}$ ($V_{\text{IN}}=0.98 \times V_{\text{OUT}}$, $I_{\text{OUT}}=200\text{ mA}$)	
Line regulation	VDL	-	2	20	mV	$V_{\text{IN}}=V_{\text{OUT}}+1.0\text{ V}$ to 5.5 V , $I_{\text{OUT}}=10\text{ }\mu\text{A}$	
Load regulation	VDLO	-	10	80	mV	$I_{\text{OUT}}=0.01\text{ mA}$ to 100 mA	
Overcurrent protection detection current	ILMAX	250	400	700	mA	$V_{\text{O}}=V_{\text{OUT}} \times 0.8$	
Output short-circuit current	ISHORT	20	70	150	mA	$V_{\text{O}}=0\text{ V}$	
Output discharge resistance	RDSC	20	40	80	Ω	$V_{\text{IN}}=4.0\text{ V}$, STBY=0 V	
Standby pull-down resistance	RSTB	500	1000	2000	k Ω		
Standby control	ON	VSTBH	1.5	-	5.5	V	
	OFF	VSTBL	-0.3	-	0.3	V	

* This product does not have radiation-proof design.

●Block diagram, recommended circuit diagram, and pin configuration diagram

BH□□TA2WNVX

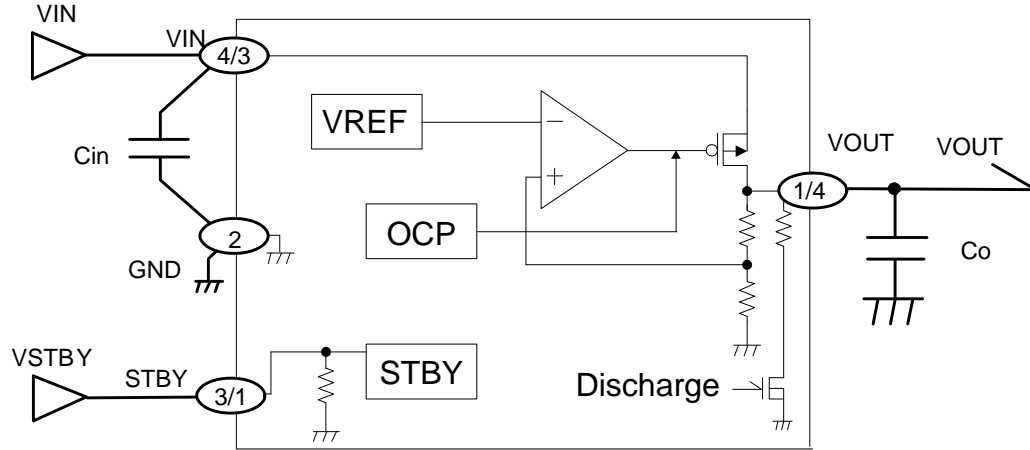

Recommended ceramic capacitor for Cin & Co
Murata Manufacturing Co., Ltd.
GRM188B11A105KA61D

Fig.1 Recommended circuit diagram

BU□□TA2WNVX(SSON004X1216)

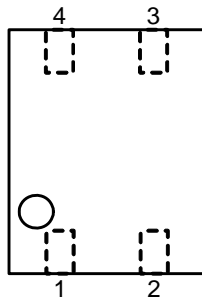

PIN No.	Symbol	Function
1	VOUT	Voltage output
2	GND	Grounding
3	STBY	ON/OFF control of output voltage (High: ON, Low: OFF)
4	VIN	Power input

BU□□TA2WHFV(HVSO5)

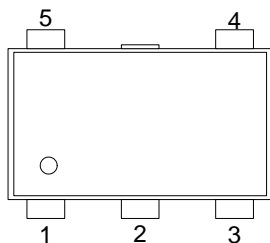

PIN No.	Symbol	Function
1	STBY	ON/OFF control of output voltage (High: ON, Low: OFF)
2	GND	Grounding
3	VIN	Power input
4	VOUT	Voltage output
5	N.C.	No Connect

●Input/Output terminal equivalent circuit schematic

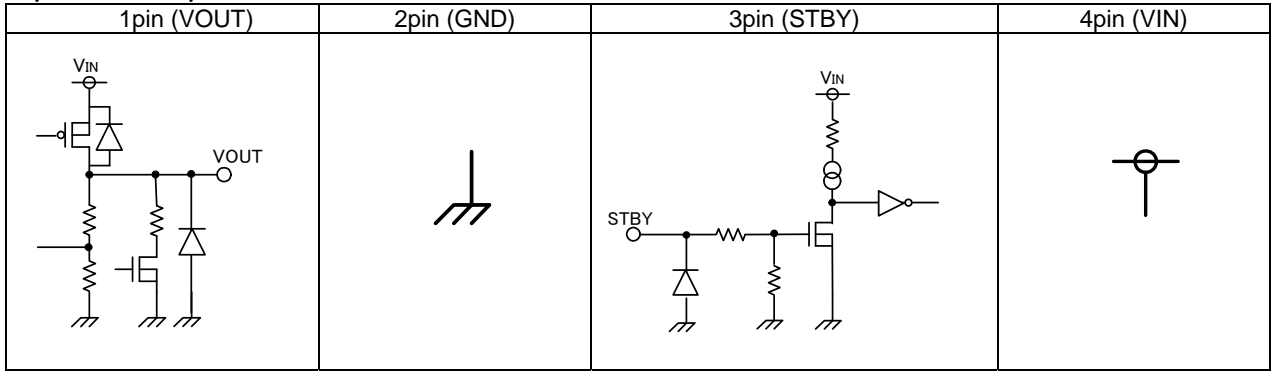

Fig. 2 Input/Output equivalent circuit

●About input/output capacitor

It is recommended to place a capacitor as close as possible to the pins between the input terminal and GND or between the output terminal and GND.

The capacitor between the input terminal and GND becomes valid when source impedance increases or when wiring is long. The larger the capacity of the output capacitor between the output terminal and GND is, the better the stability and characteristics in output load fluctuation become. However, please check the status of actual implementation. Ceramic capacitors generally have variation, temperature characteristics, and direct current bias characteristics and the capacity value also decreases with time depending on the usage conditions. It is recommended to select a ceramic capacitor upon inquiring about detailed data of the related manufacturer.

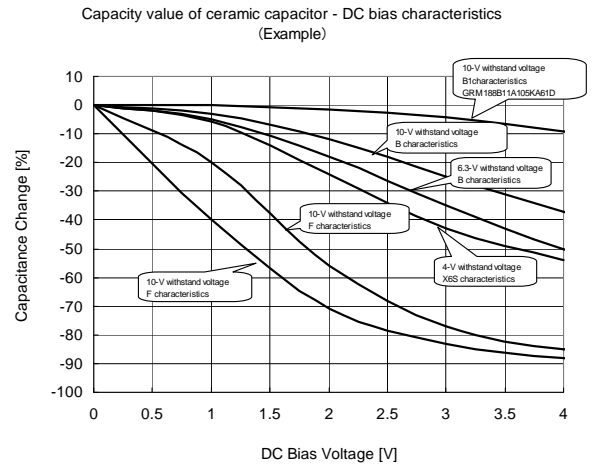

Fig.3 Capacity – bias characteristics

●About the equivalent series resistance (ESR) of a ceramic capacitor

Capacitors generally have ESR (equivalent series resistance) and it operates stably in the ESR-IOUT area shown on the right. Since ceramic capacitors, tantalum capacitors, electrolytic capacitors, etc. generally have different ESR, please check the ESR of the capacitor to be used and use it within the stability area range shown in the right graph for evaluation of the actual application.

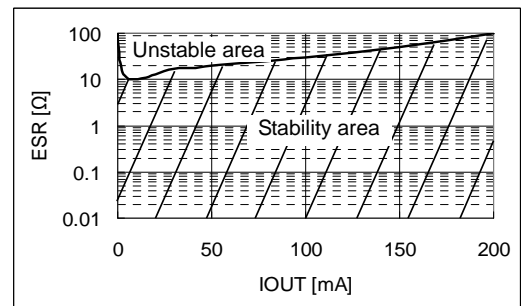

Fig.4 Stability area characteristics (Example)

●Reference data BU15TA2WNVX / HFV (Ta=25°C unless otherwise specified.)

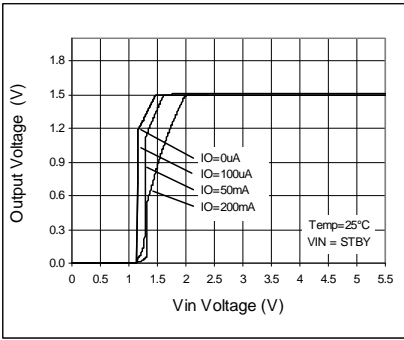

Fig. 5 Output Voltage

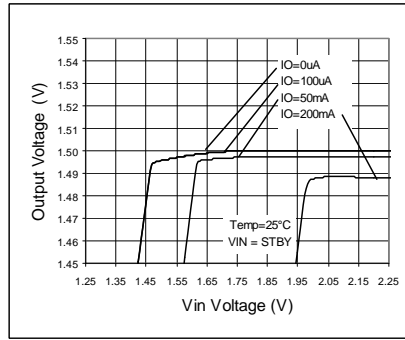

Fig. 6 Line Regulation

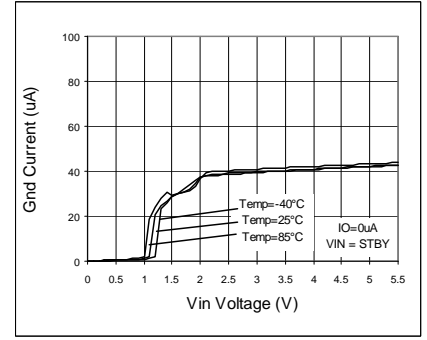

Fig. 7 Circuit Current IGND

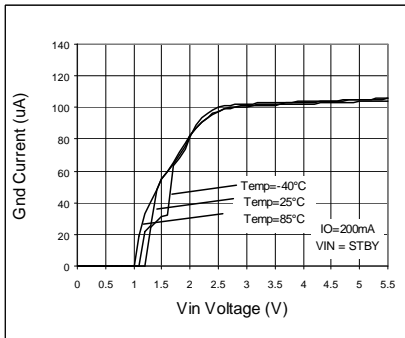

Fig. 8 Circuit Current IGND

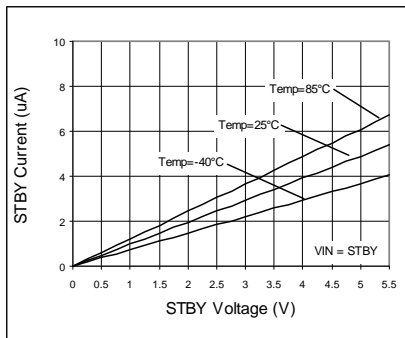

Fig. 9 STBY Input Current

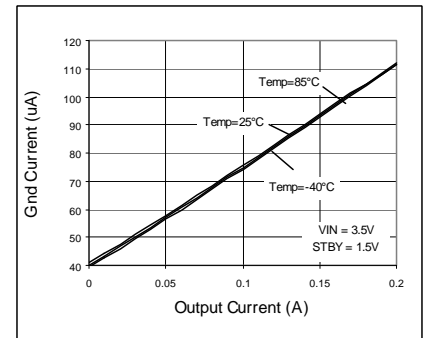

Fig. 10 IOOUT - I_GND

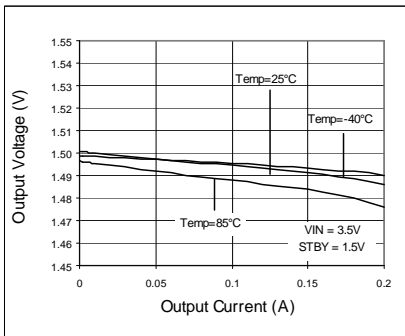

Fig. 11 Load Regulation

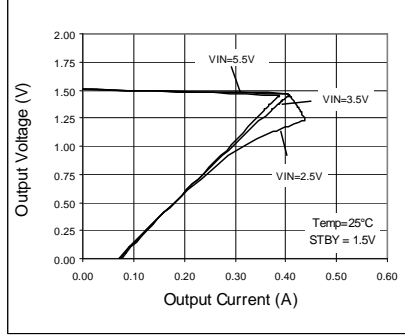

Fig. 12 OCP Threshold

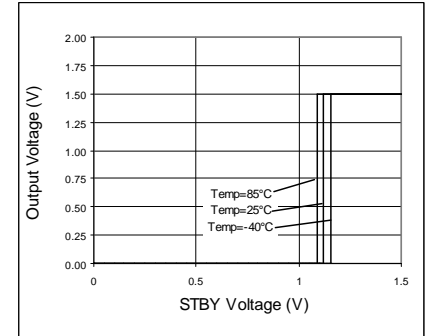

Fig. 13 STBY Threshold

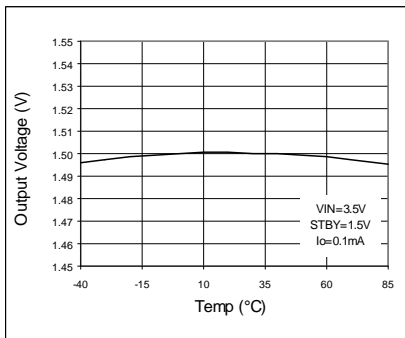

Fig. 14 VOUT vs. Temp

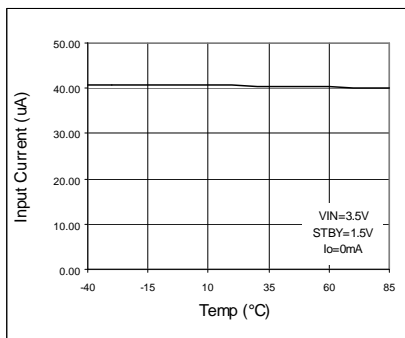

Fig. 15 IGND vs. Temp

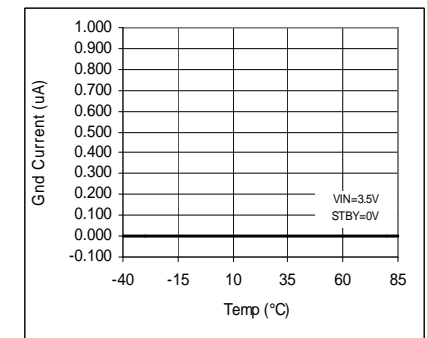

Fig. 16 IGND vs. Temp (STBY)

●Reference data BU15TA2WNVX /HFV (Ta=25°C unless otherwise specified.)

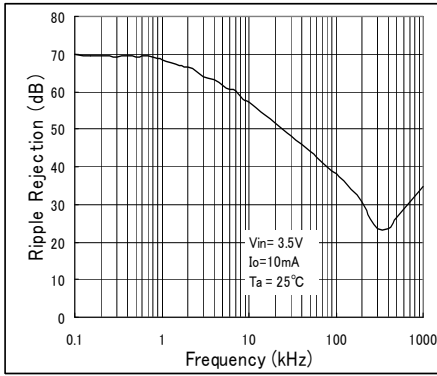

Fig. 17 Ripple Rejection vs. Freq.

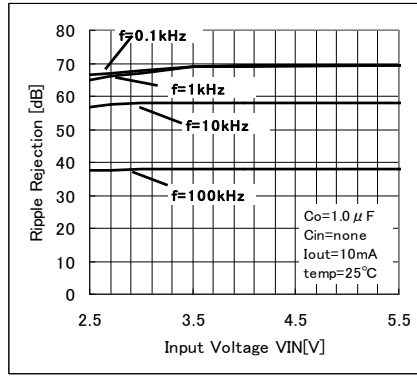

Fig. 18 Ripple Rejection vs. VIN (Iout=10 mA)

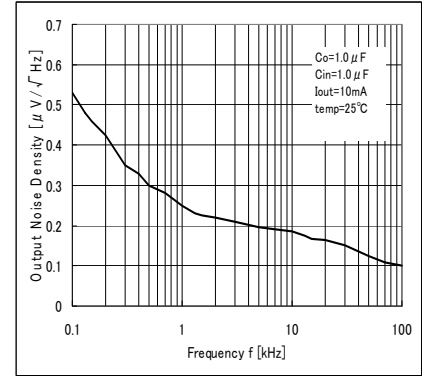

Fig. 19 Output Noise Spectral Density vs. Freq.

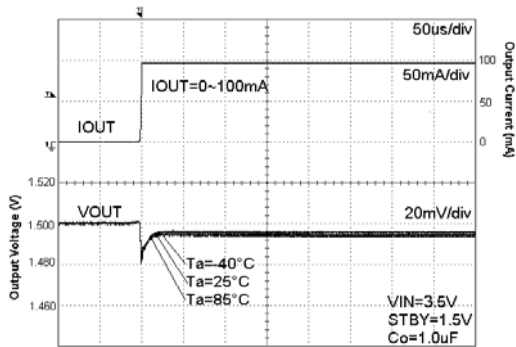

Fig. 20 Load Response

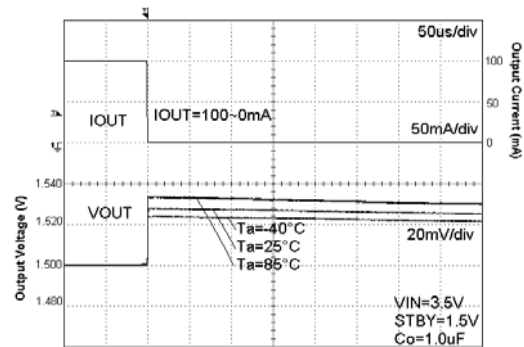

Fig. 21 Load Response

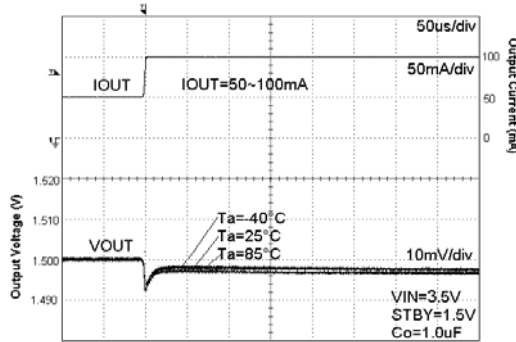

Fig. 22 Load Response

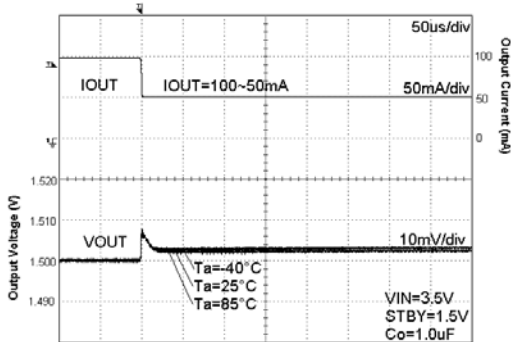

Fig. 23 Load Response

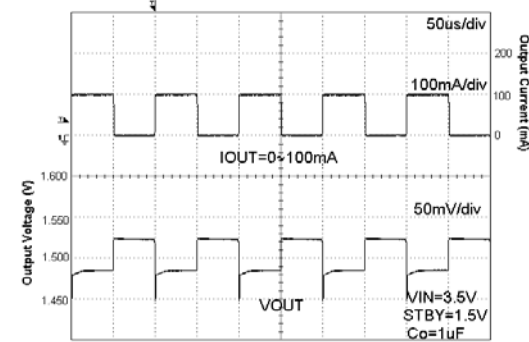

Fig. 24 Load Response Current Pulse=10 kHz

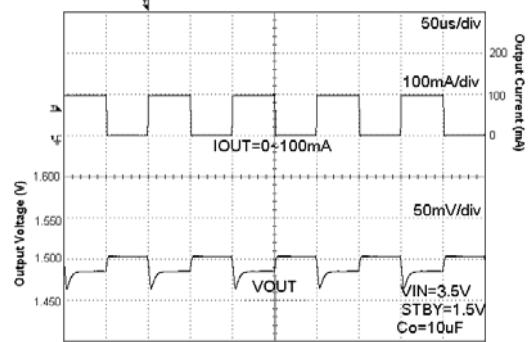

Fig. 25 Load Response Current Pulse=10 kHz

●Reference data BU15TA2WNVX / HFV (Ta=25°C unless otherwise specified.)

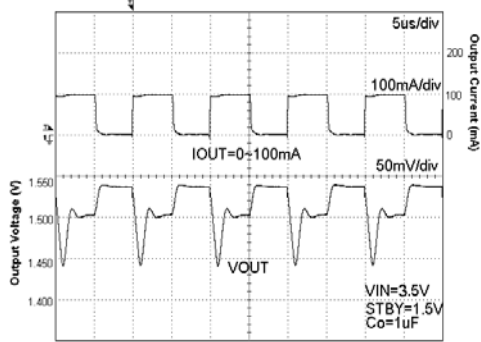

Fig. 26 Load Response
Current Pulse=100 kHz

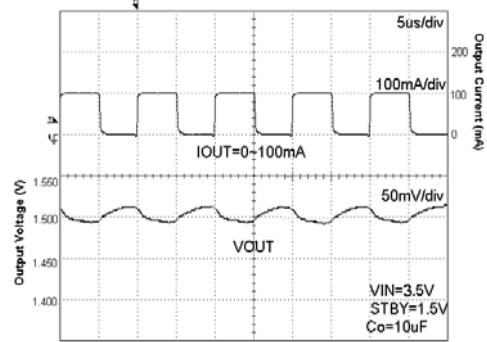

Fig. 27 Load Response
Current Pulse=100 kHz

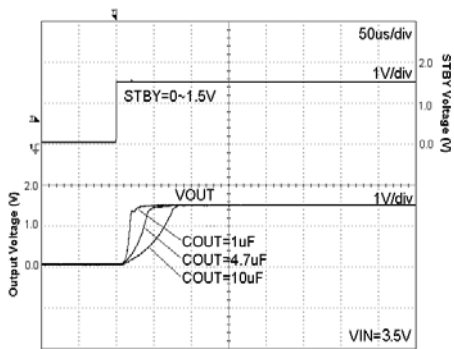

Fig. 28 Startup Time
Iout = 0 mA

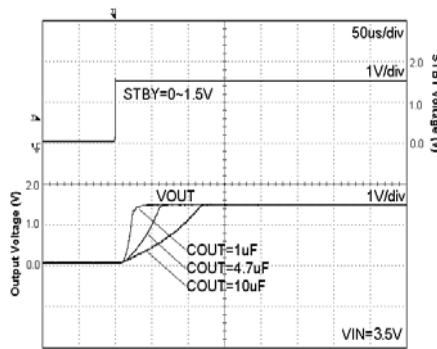

Fig. 29 Startup Time
Iout = 200 mA

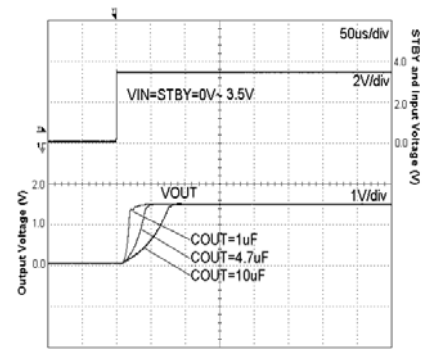

Fig. 30 Startup Time (STBY=VIN)
Iout = 0 mA

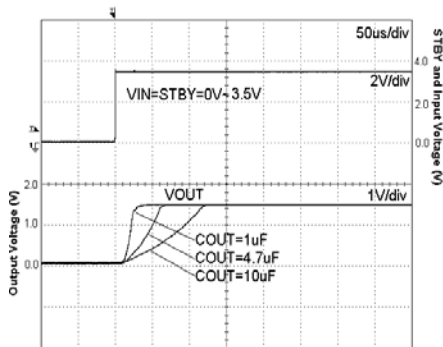

Fig. 31 Startup Time (STBY=VIN)
Iout = 200mA

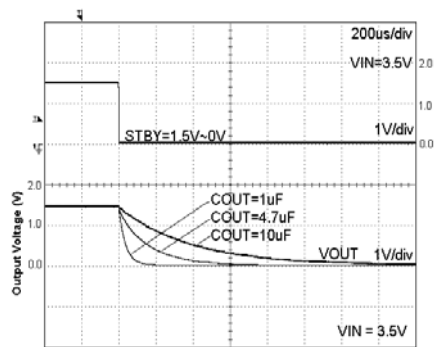

Fig. 32 Discharge Time
Iout = 0 mA

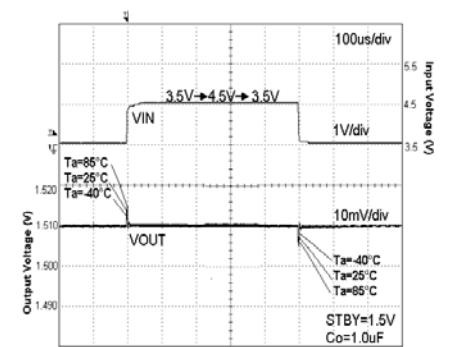

Fig. 33 VIN Response
Iout = 10 mA

●Reference data BU18TA2WNVX / HFV (Unless otherwise specified, Ta=25°C)

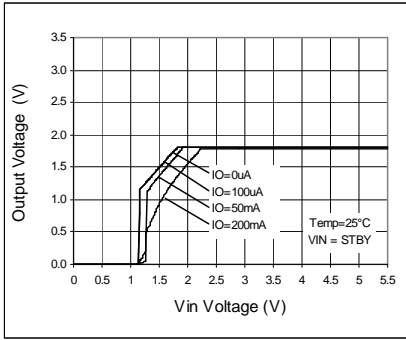

Fig. 34 Output Voltage

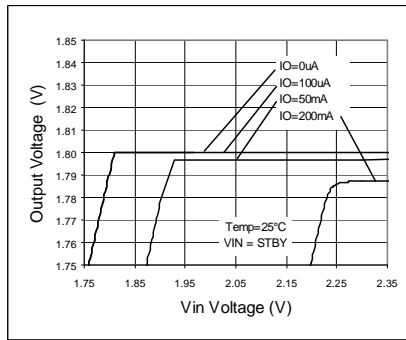

Fig. 35 Line Regulation

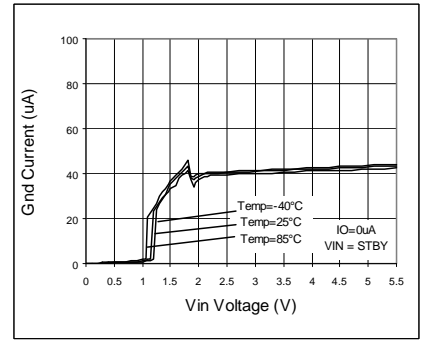

Fig. 36 Circuit Current IGND

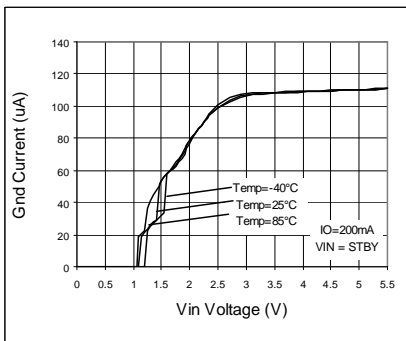

Fig. 37 Circuit Current IGND

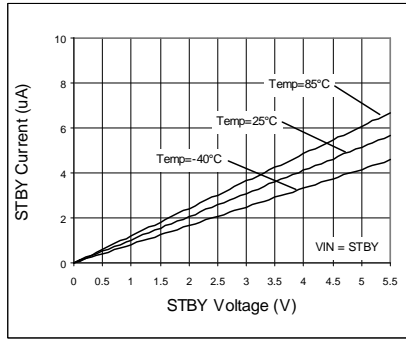

Fig. 38 STBY Input Current

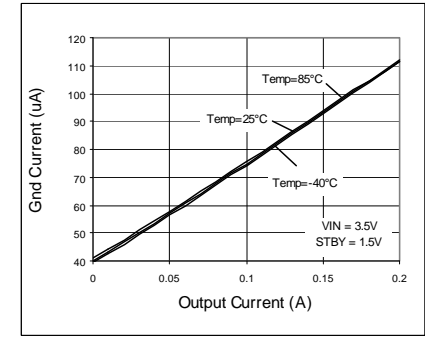

Fig. 39 IOUT - IGND

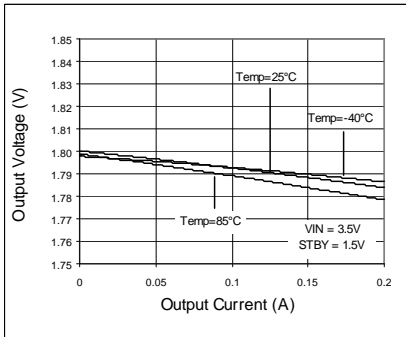

Fig. 40 Load Regulation

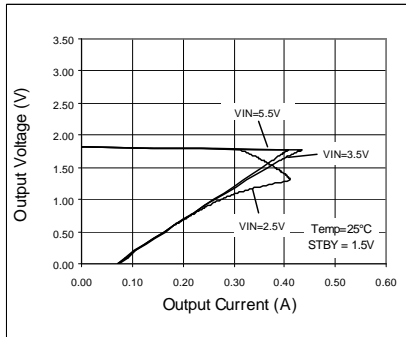

Fig. 41 OCP Threshold

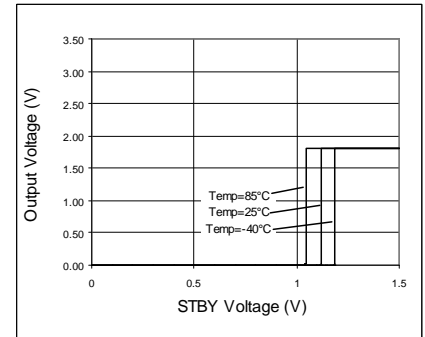

Fig. 42 STBY Threshold

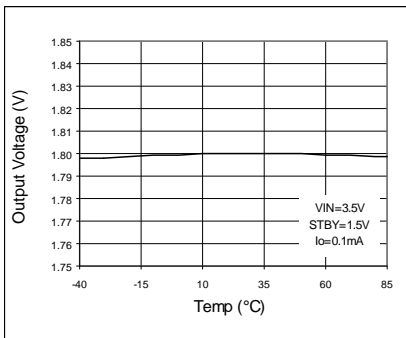

Fig. 43 VOUT vs Temp

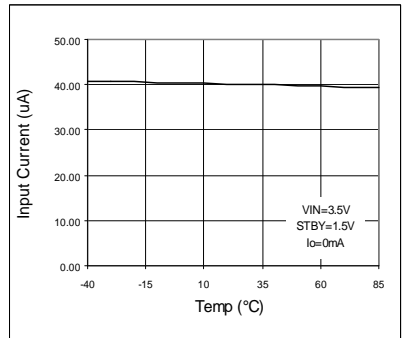

Fig. 44 IGND vs Temp

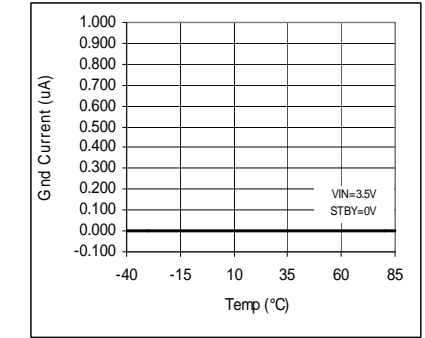

Fig. 45 IGND vs Temp (STBY)

●Reference data BU18TA2WNVX / HFV (Unless otherwise specified, Ta=25°C)

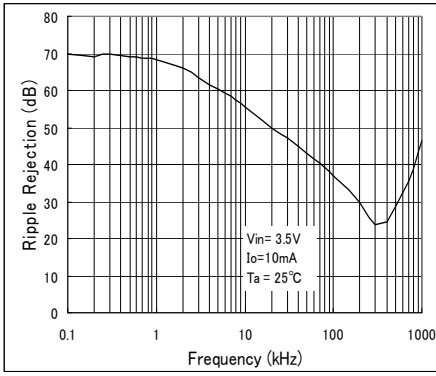

Fig. 46 Ripple Rejection VS Freq.

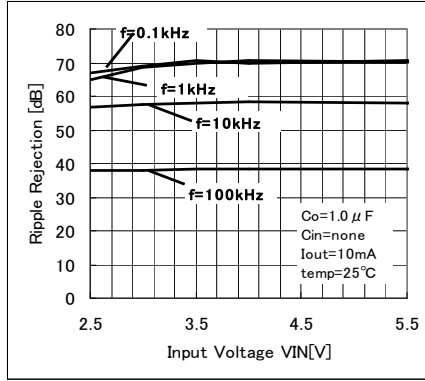

Fig. 47 Ripple Rejection VS VIN

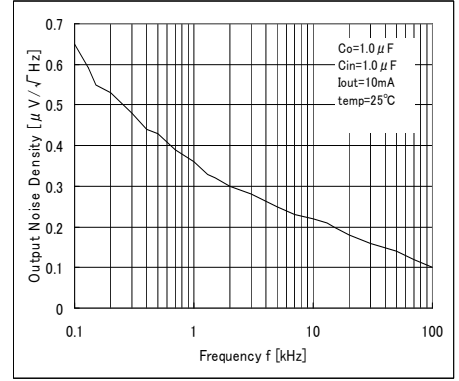

Fig. 48 Output Noise Spectral Density VS Freq.

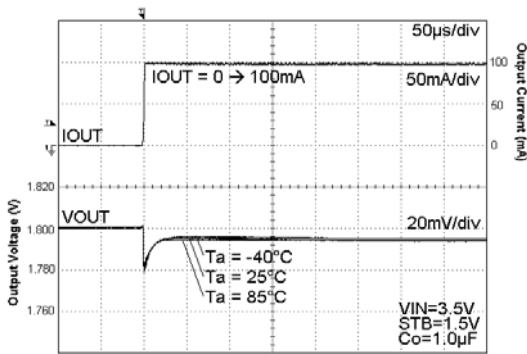

Fig. 49 Load Response

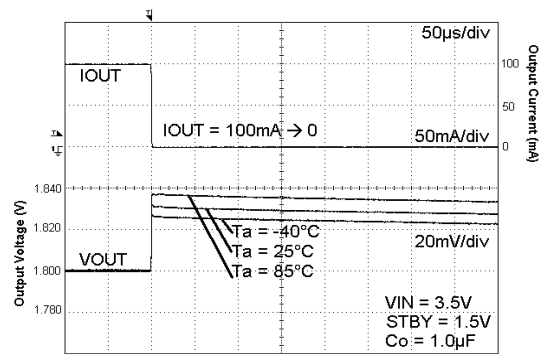

Fig. 50 Load Response

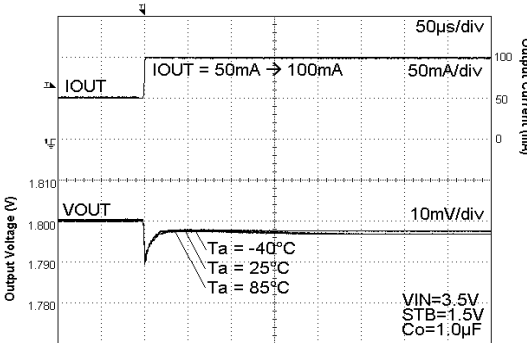

Fig. 51 Load Response

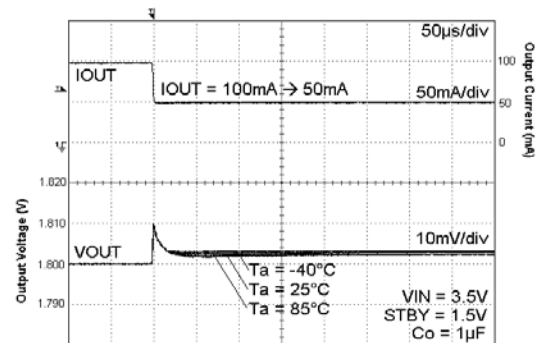

Fig. 52 Load Response

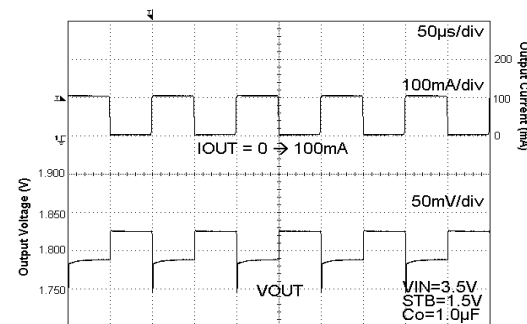

Fig. 53 Load Response
Current Pulse=10kHz

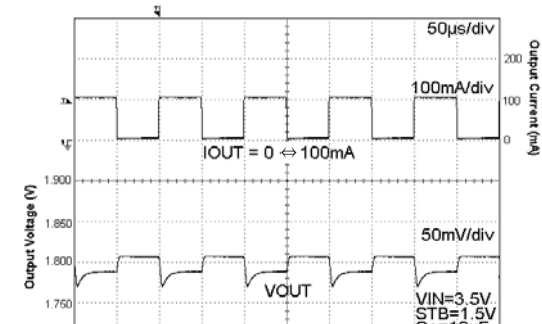

Fig. 54 Load Response
Current Pulse=10kHz

●Reference data BU18TA2WNVX / HFV (Unless otherwise specified, Ta=25°C)

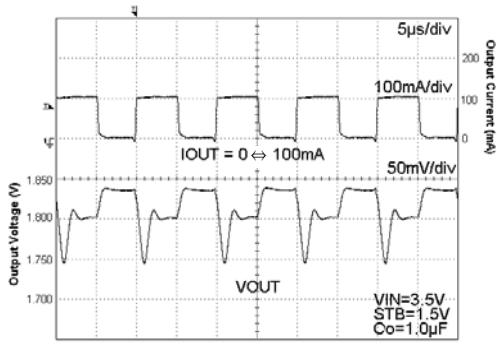

Fig. 55 Load Response
Current Pulse=100kHz

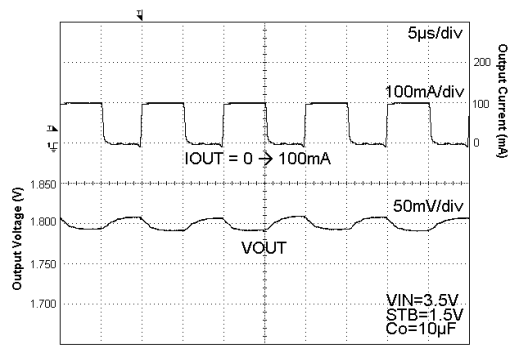

Fig. 56 Load Response
Current Pulse=100kHz

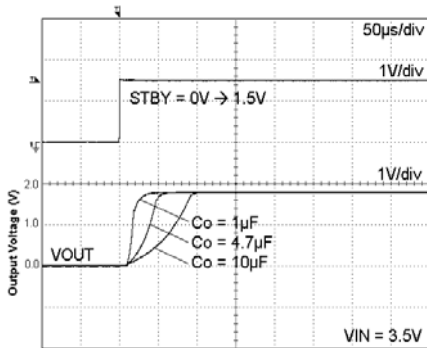

Fig. 57 Start Up Time
Iout = 0mA

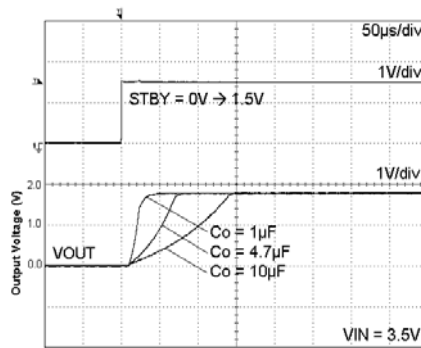

Fig. 58 Start Up Time
Iout = 200mA

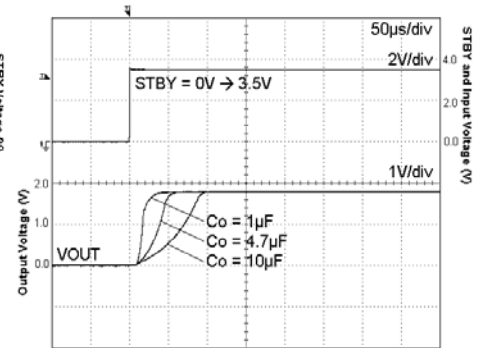

Fig. 59 Start Up Time (STBY=VIN)
Iout = 0mA

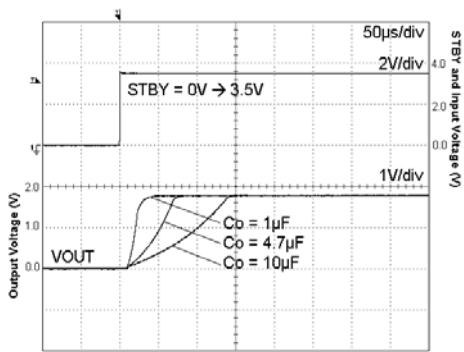

Fig. 60 Start Up Time(STBY=VIN)
Iout = 200mA

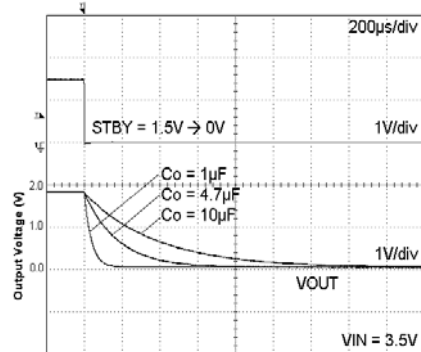

Fig. 61 Discharge Time
Iout = 0mA

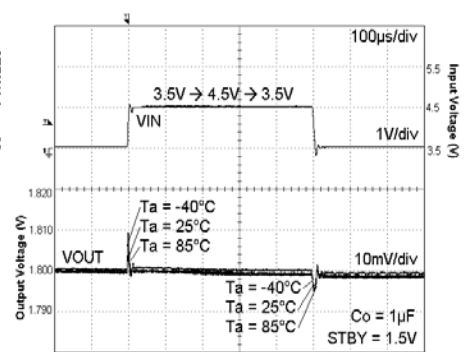

Fig. 62 VIN Response
Iout = 10mA

●Reference data BU25TA2WNVX / HFV (Unless otherwise specified, Ta=25°C)

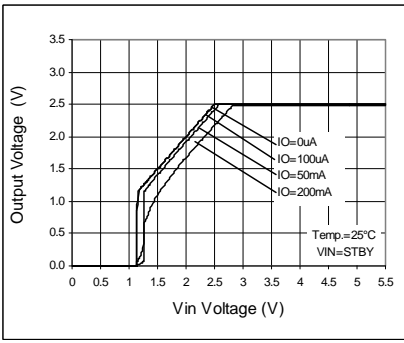

Fig. 63 Output Voltage

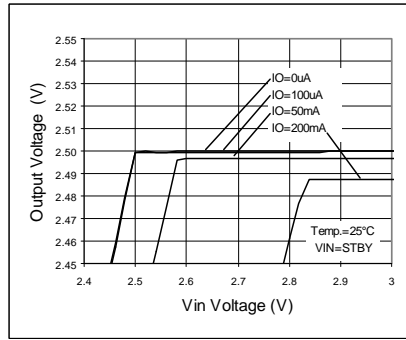

Fig. 64 Line Regulation

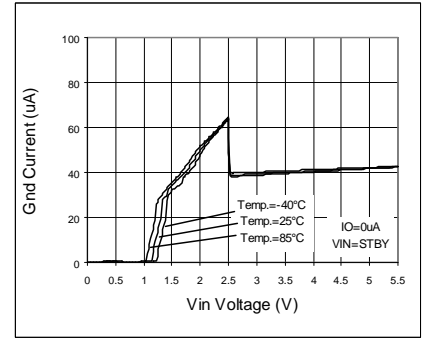

Fig. 65 Circuit Current IGND

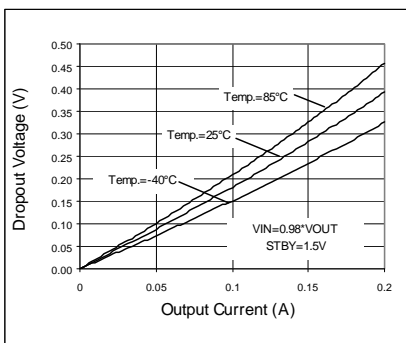

Fig. 66 Dropout Voltage

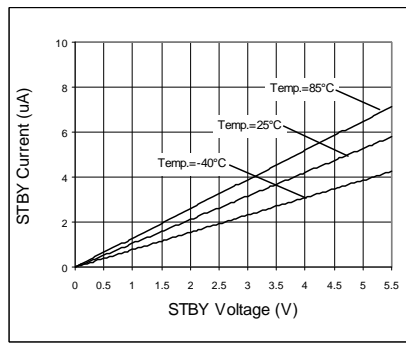

Fig. 67 STBY Input Current

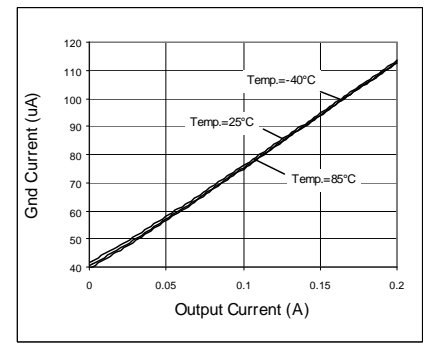

Fig. 68 IOUT - IGND

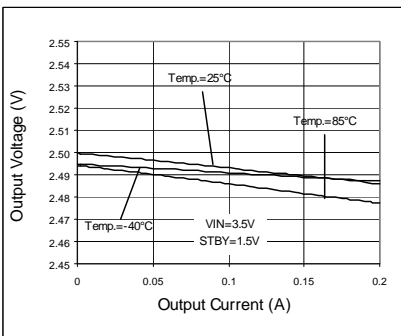

Fig. 69 Load Regulation

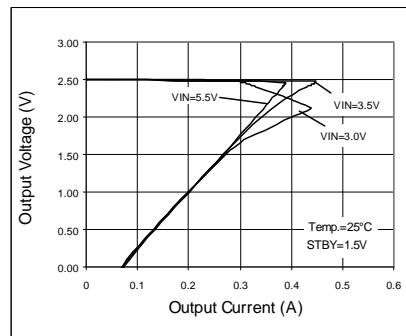

Fig. 70 OCP Threshold

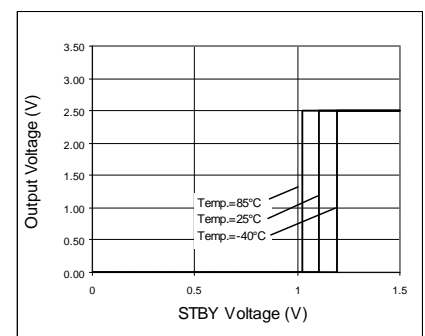

Fig. 71 STBY Threshold

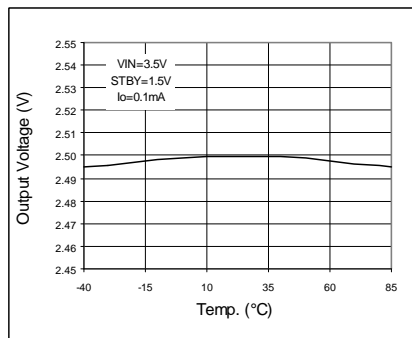

Fig. 72 VOUT vs Temp

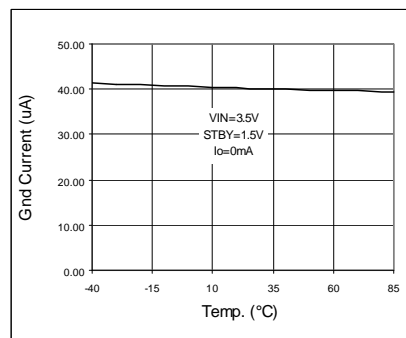

Fig. 73 IGND vs Temp

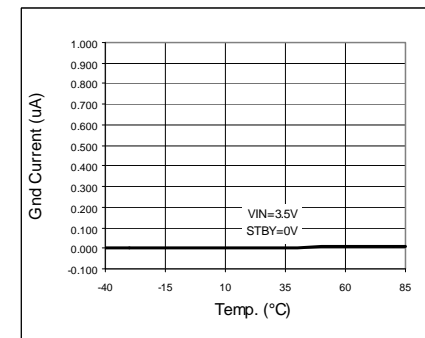

Fig. 74 IGND vs Temp (STBY)

●Reference data BU25TA2WNVX / HFV (Unless otherwise specified, Ta=25°C)

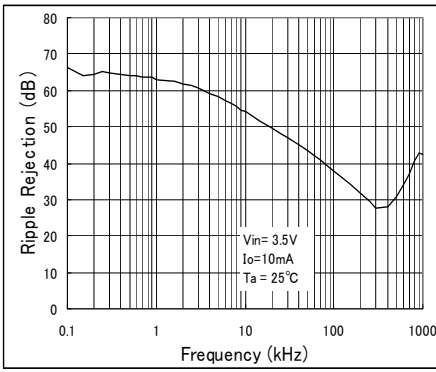

Fig. 75 Ripple Rejection VS Freq.

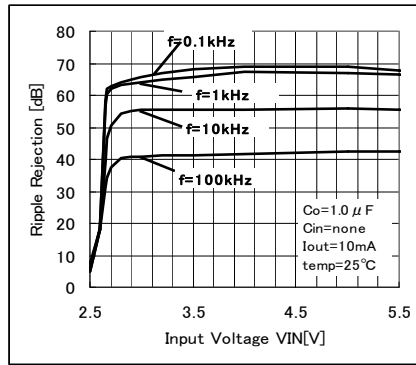

Fig. 76 Ripple Rejection VS VIN

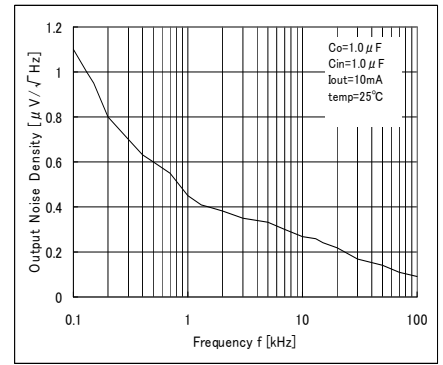

Fig. 77 Output Noise Spectral Density VS Freq.

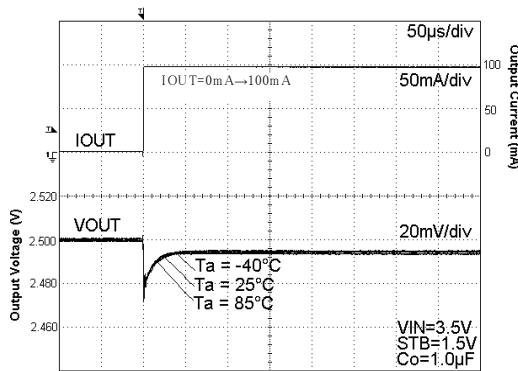

Fig. 78 Load Response

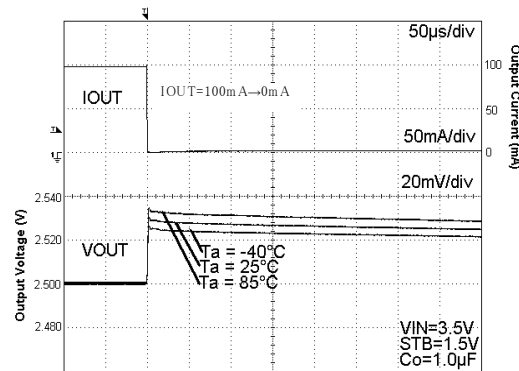

Fig. 79 Load Response

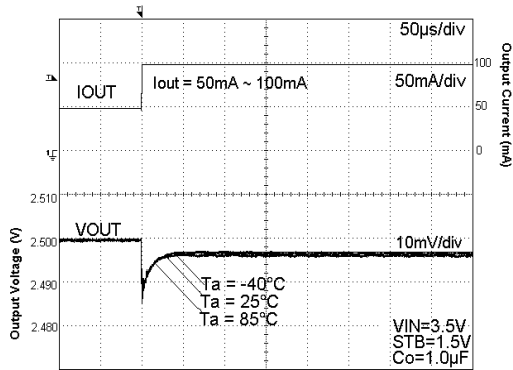

Fig. 80 Load Response

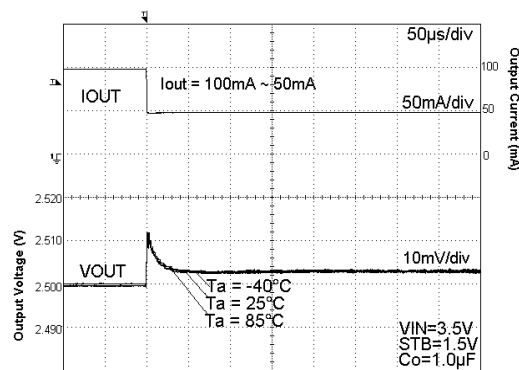

Fig. 81 Load Response

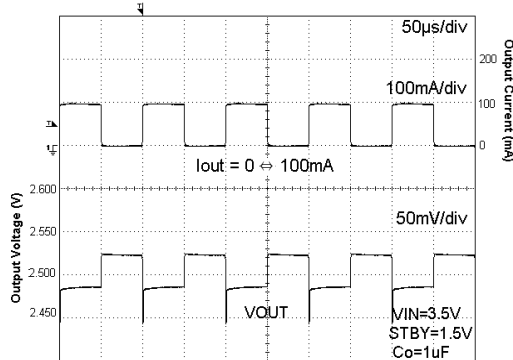

Fig. 82 Load Response
Current Pulse=10kHz

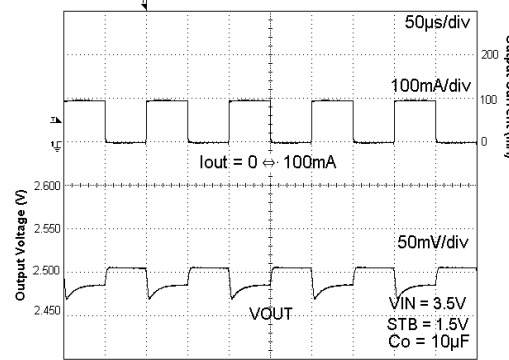

Fig. 83 Load Response
Current Pulse=10kHz

●Reference data BU25TA2WNVX / HFV (Unless otherwise specified, Ta=25°C)

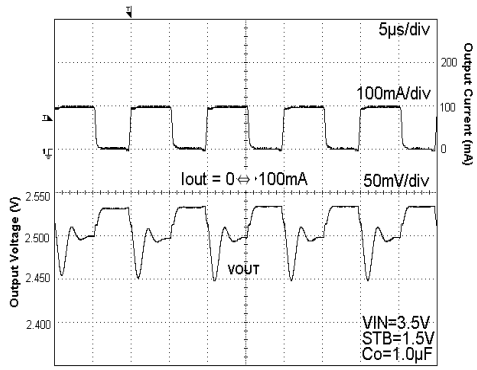

Fig. 84 Load Response
Current Pulse=100kHz

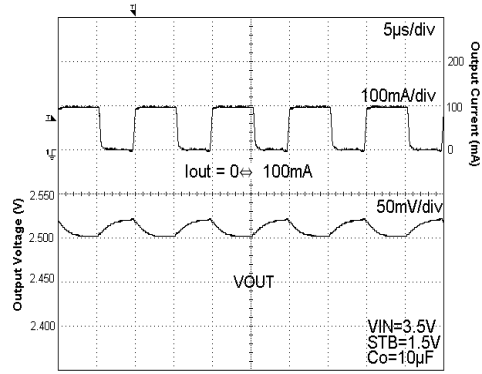

Fig. 85 Load Response
Current Pulse=100kHz

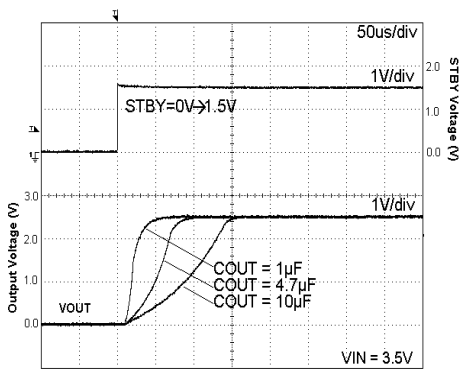

Fig. 86 Start Up Time
Iout = 0mA

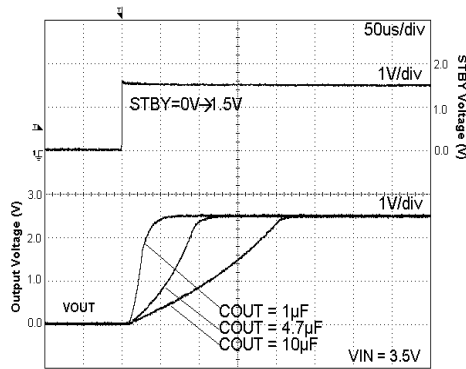

Fig. 87 Start Up Time
Iout = 200mA

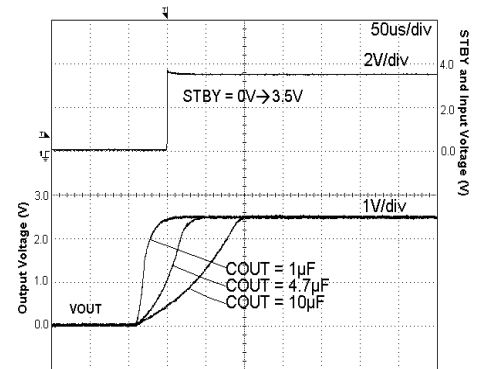

Fig. 88 Start Up Time (STBY=VIN)
Iout = 0mA

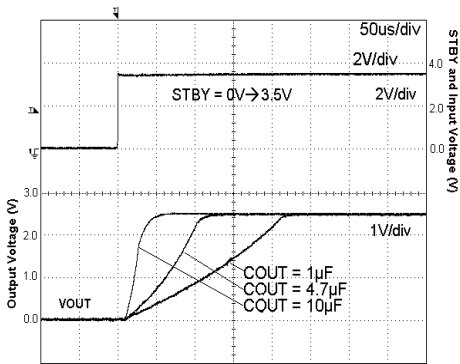

Fig. 89 Start Up Time(STBY=VIN)
Iout = 200mA

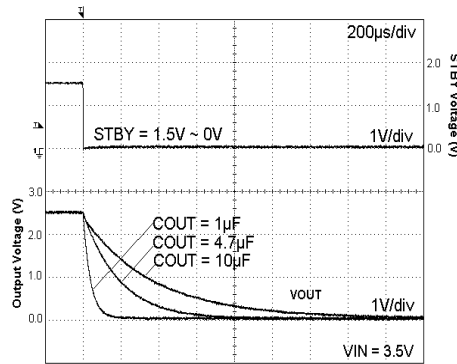

Fig. 90 Discharge Time
Iout = 0mA

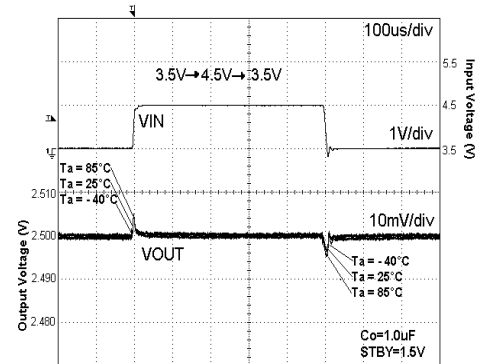

Fig. 91 VIN Response
Iout = 10mA

●Reference data BU28TA2WNVX / HFV (Unless otherwise specified, Ta=25°C)

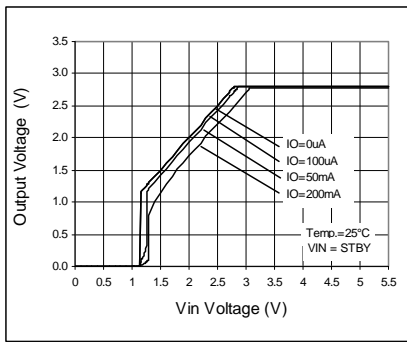

Fig. 92 Output Voltage

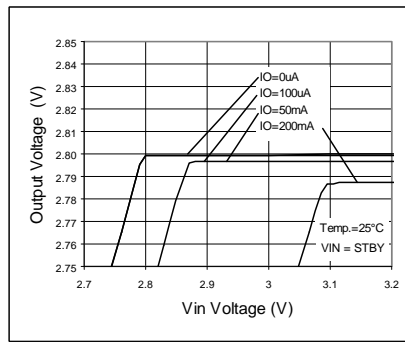

Fig. 93 Line Regulation

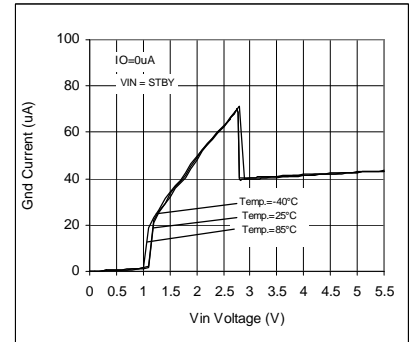

Fig. 94 Circuit Current IGND

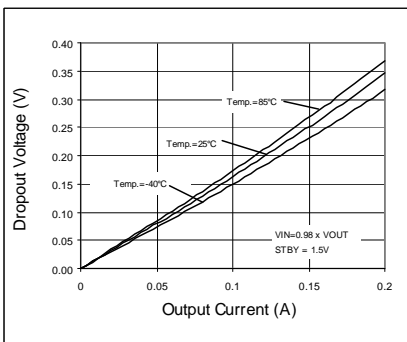

Fig. 95 Dropout Voltage

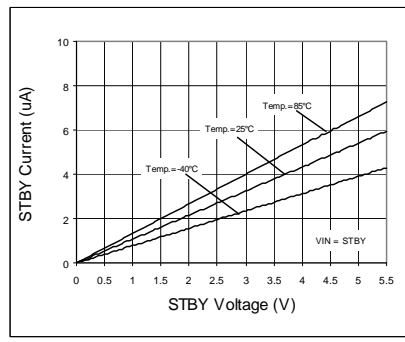

Fig. 96 STBY Input Current

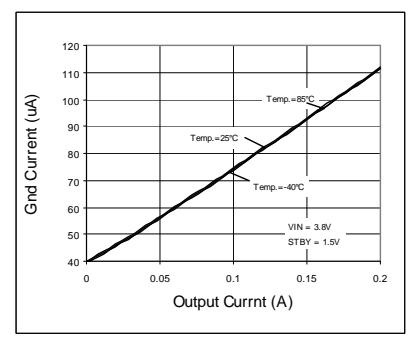

Fig. 97 IOOUT - IGND

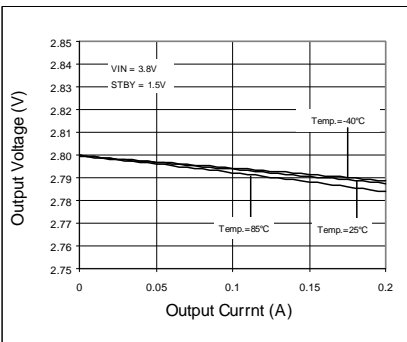

Fig. 98 Load Regulation

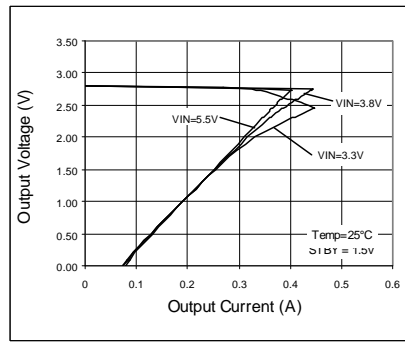

Fig. 99 OCP Threshold

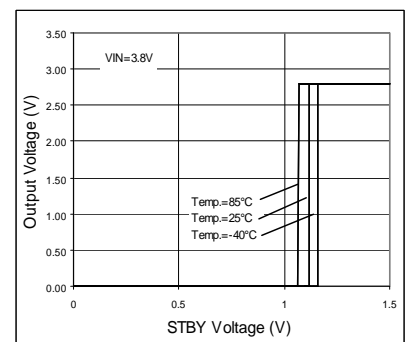

Fig. 100 STBY Threshold

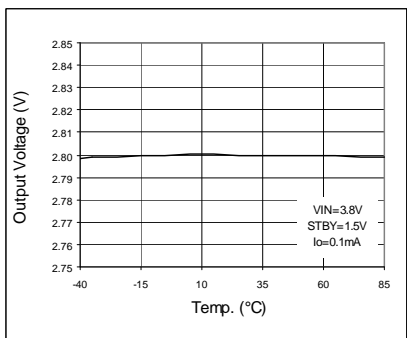

Fig. 101 VOUT vs Temp

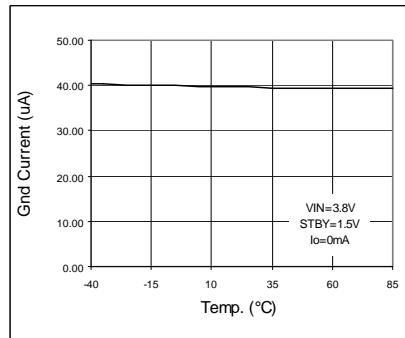

Fig. 102 IGND vs Temp

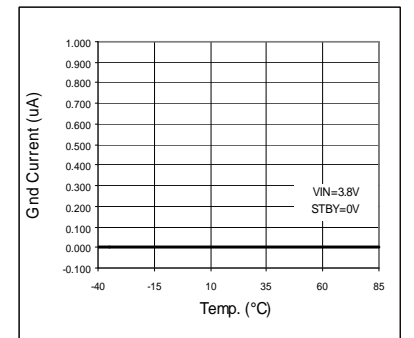

Fig. 103 IGND vs Temp (STBY)

●Reference data BU28TA2WNVX / HFV (Unless otherwise specified, Ta=25°C)

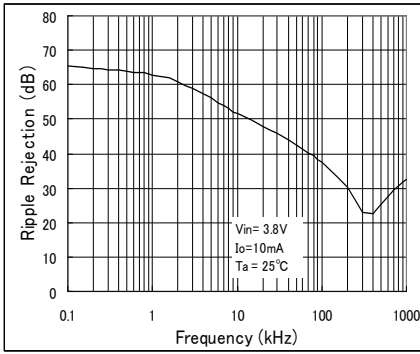

Fig. 104 Ripple Rejection VS Freq.

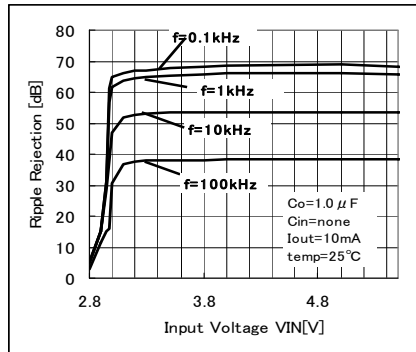

Fig. 105 Ripple Rejection VS VIN

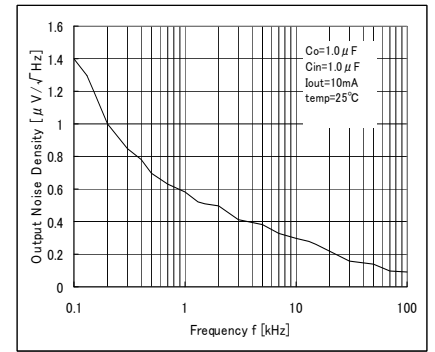

Fig. 106 Output Noise Spectral Density VS Freq.

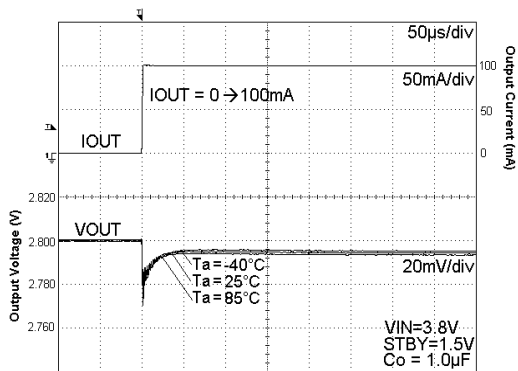

Fig. 107 Load Response

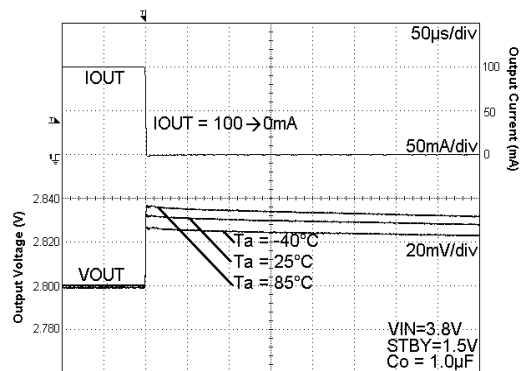

Fig. 108 Load Response

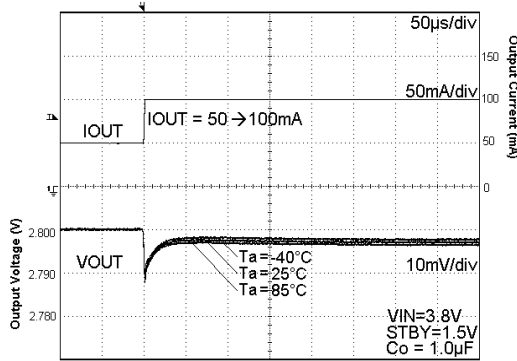

Fig. 109 Load Response

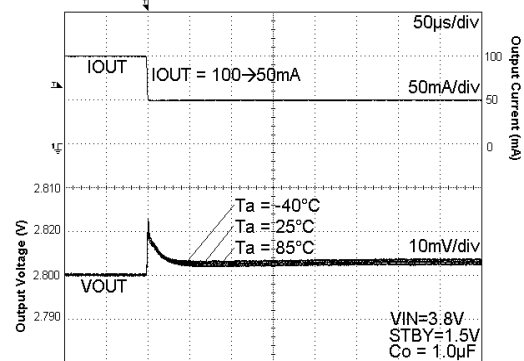

Fig. 110 Load Response

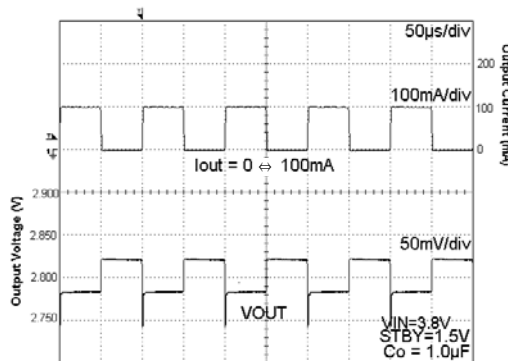

Fig. 111 Load Response Current Pulse=10kHz

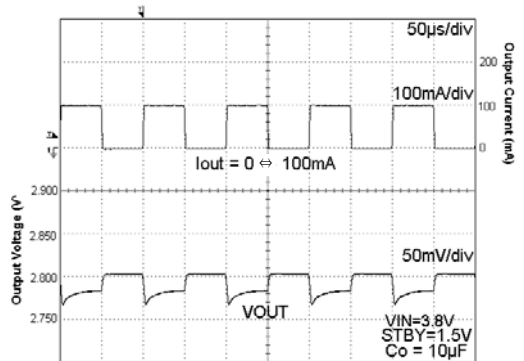

Fig. 112 Load Response Current Pulse=10kHz

●Reference data BU28TA2WNVX / HFV (Unless otherwise specified, Ta=25°C)

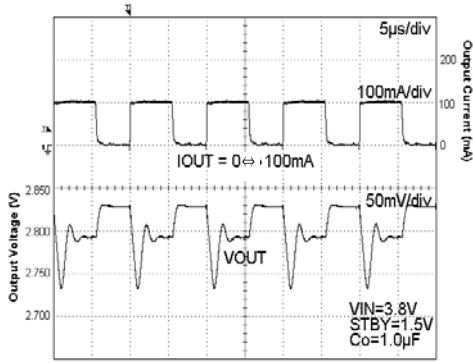

Fig. 113 Load Response
Current Pulse=100kHz

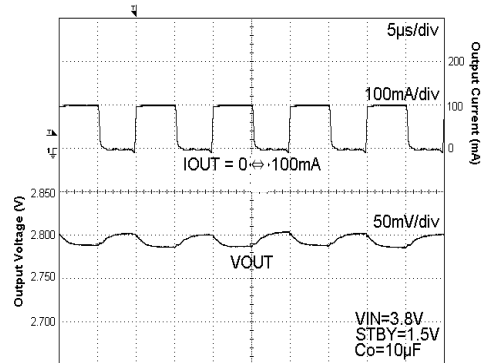

Fig. 114 Load Response
Current Pulse=100kHz

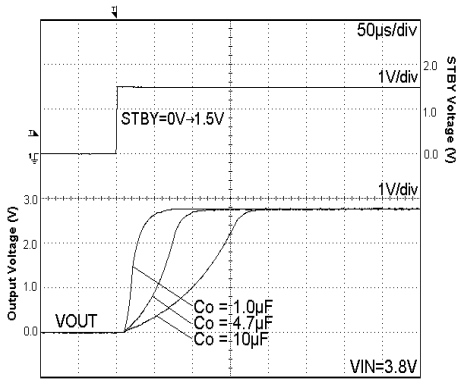

Fig. 115 Start Up Time
Iout = 0mA

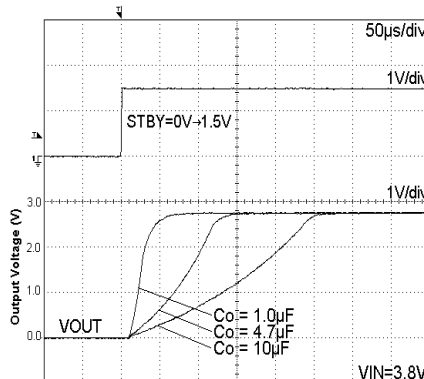

Fig. 116 Start Up Time
Iout = 200mA

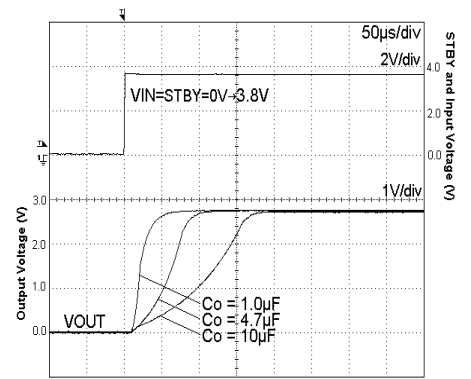

Fig. 117 Start Up Time (STBY=VIN)
Iout = 0mA

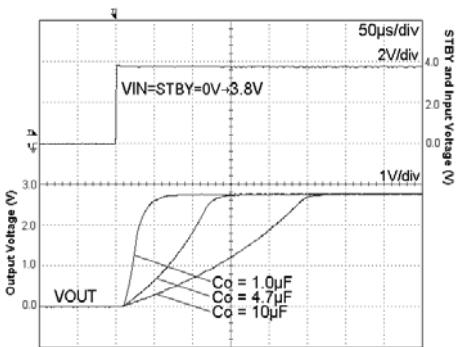

Fig. 118 Start Up Time (STBY=VIN)
Iout = 200mA

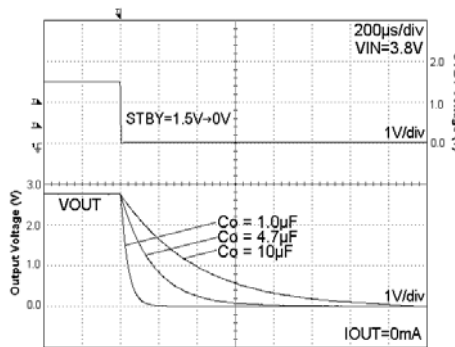

Fig. 119 Discharge Time
Iout = 0mA

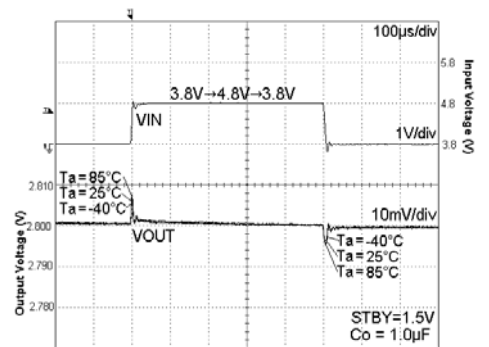

Fig. 120 VIN Response
Iout = 10mA

●Reference data BU30TA2WNVX / HFV (Unless otherwise specified, Ta=25°C)

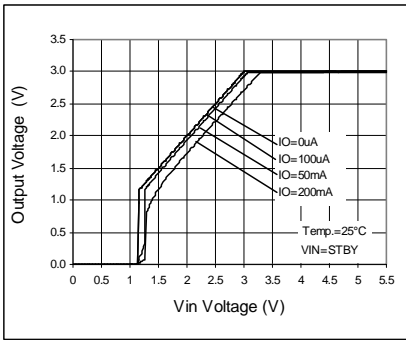

Fig. 121 Output Voltage

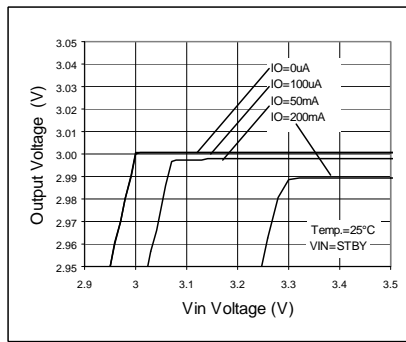

Fig. 122 Line Regulation

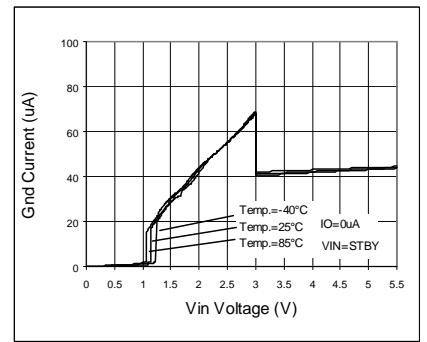

Fig. 123 Circuit Current IGND

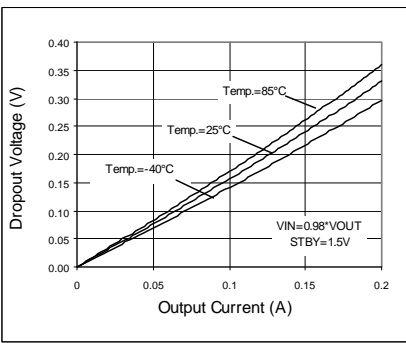

Fig. 124 Dropout Voltage

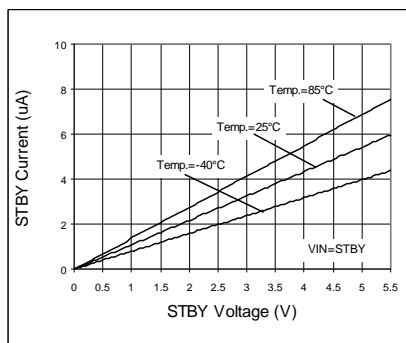

Fig. 125 STBY Input Current

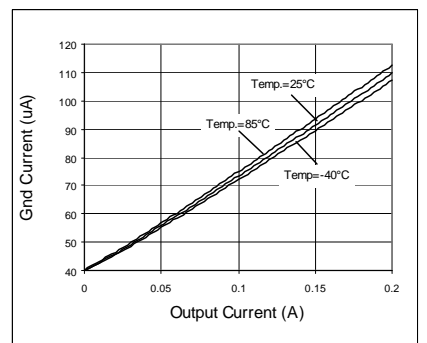

Fig. 126 IOOUT - IGND

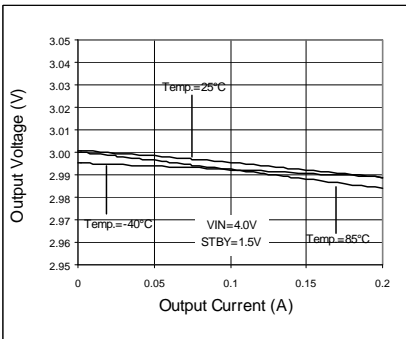

Fig. 127 Load Regulation

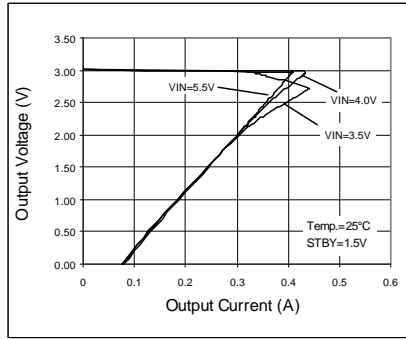

Fig. 128 OCP Threshold

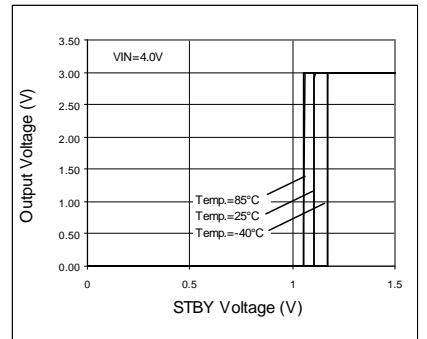

Fig. 129 STBY Threshold

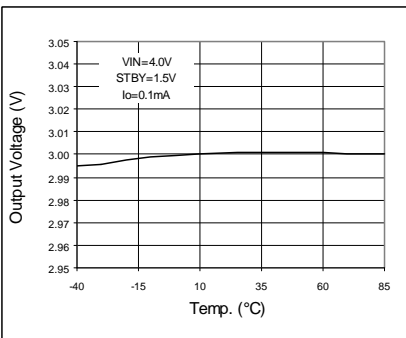

Fig. 130 VOUT vs Temp

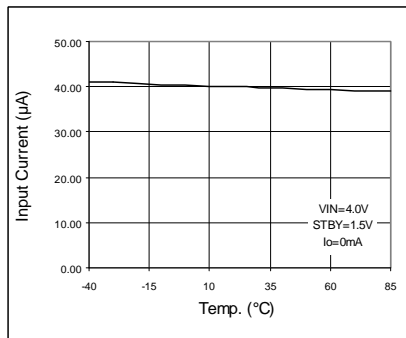

Fig. 131 IGND vs Temp

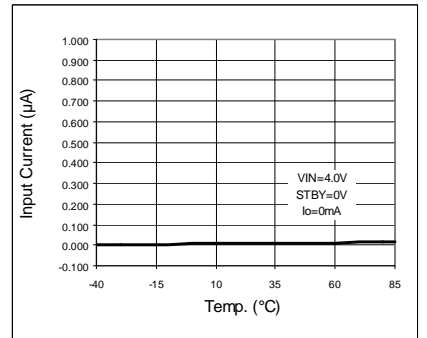

Fig. 132 IGND vs Temp (STBY)

●Reference data BU30TA2WNVX / HFV (Unless otherwise specified, Ta=25°C)

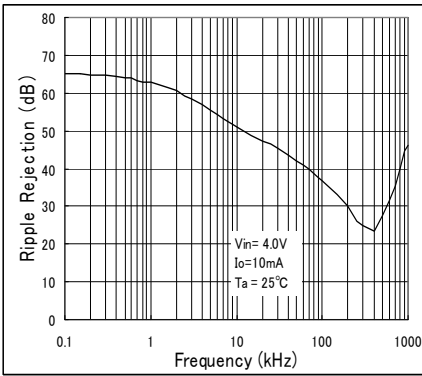

Fig. 133 Ripple Rejection VS Freq.

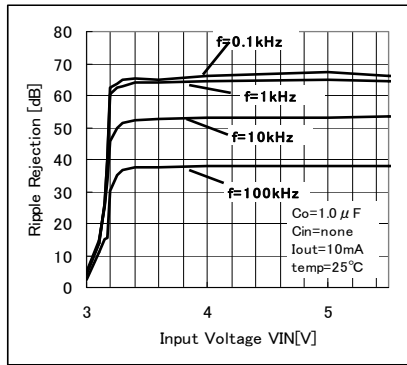

Fig. 134 Ripple Rejection VS VIN

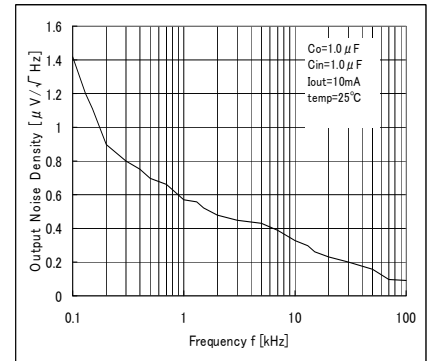

Fig. 135 Output Noise Spectral Density VS Freq.

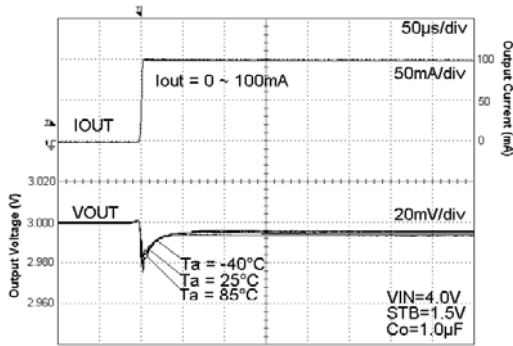

Fig. 136 Load Response

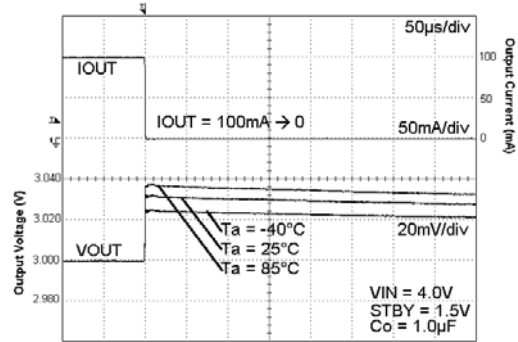

Fig. 137 Load Response

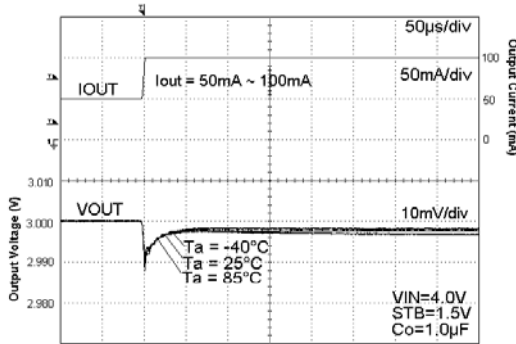

Fig. 138 Load Response

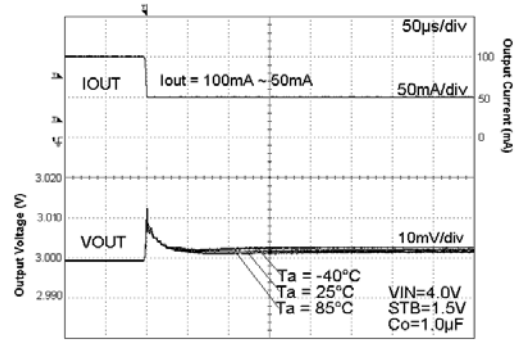

Fig. 139 Load Response

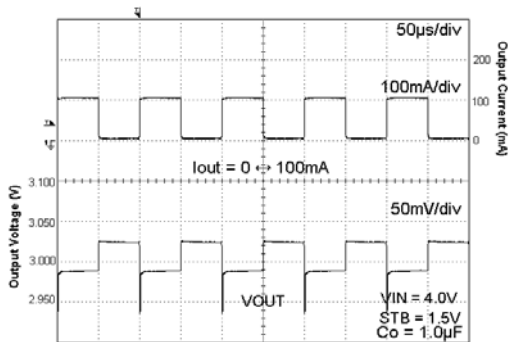

Fig. 140 Load Response Current Pulse=10kHz

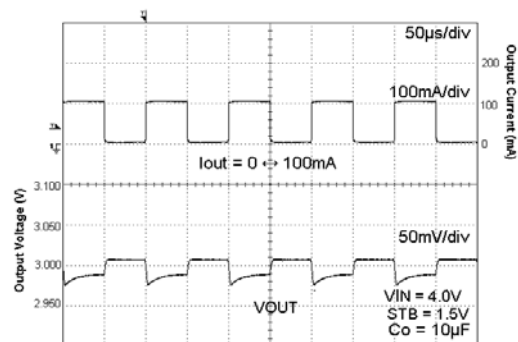

Fig. 141 Load Response Current Pulse=10kHz

●Reference data BU30TA2WNVX / HFV (Unless otherwise specified, Ta=25°C)

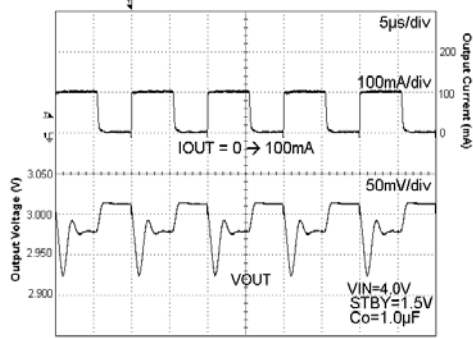

Fig. 142 Load Response
Current Pulse=100kHz

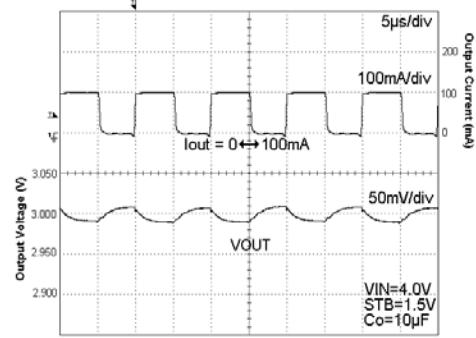

Fig. 143 Load Response
Current Pulse=100kHz

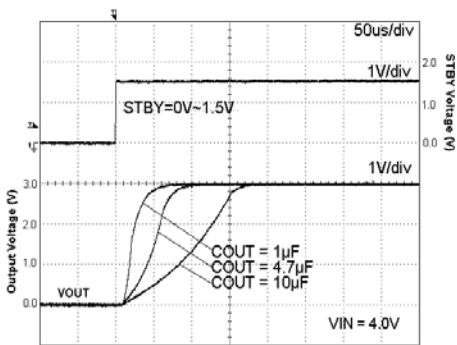

Fig. 144 Start Up Time
Iout = 0mA

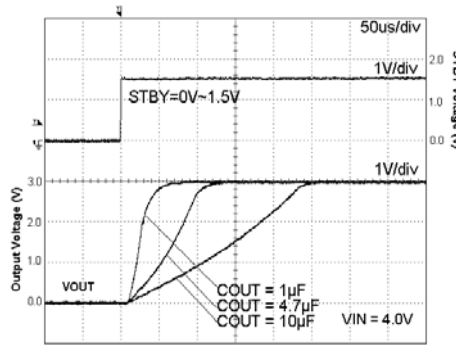

Fig. 145 Start Up Time
Iout = 200mA

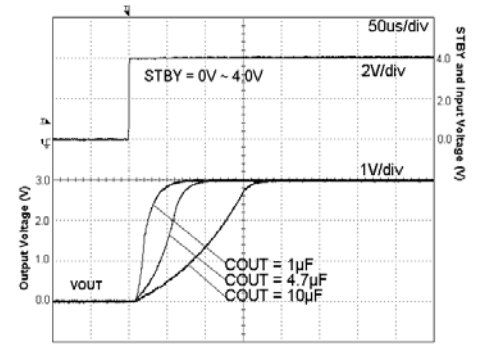

Fig. 146 Start Up Time (STBY=VIN)
Iout = 0mA

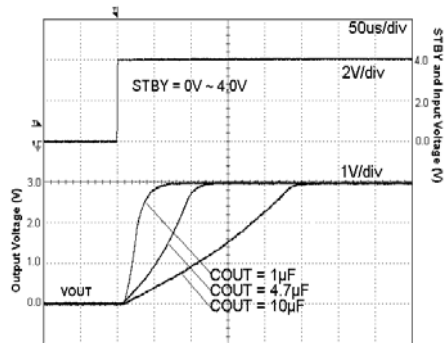

Fig. 147 Start Up Time(STBY=VIN)
Iout = 200mA

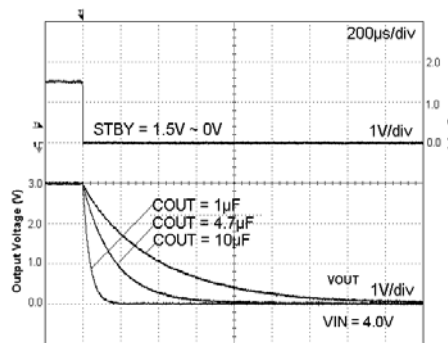

Fig. 148 Discharge Time
Iout = 0mA

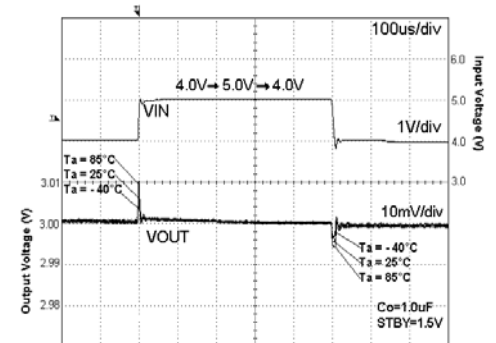

Fig. 149 VIN Response
Iout = 10mA

●Reference data BU33TA2WNVX / HFV (Unless otherwise specified, Ta=25°C)

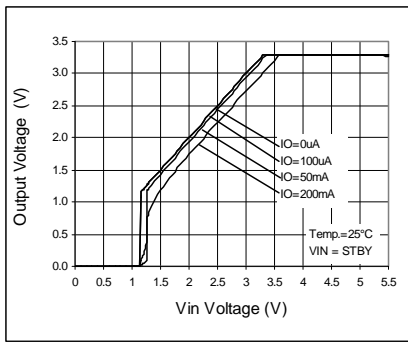

Fig. 150 Output Voltage

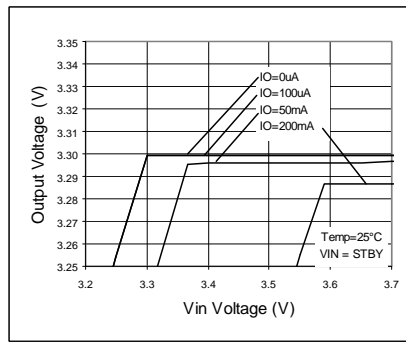

Fig. 151 Line Regulation

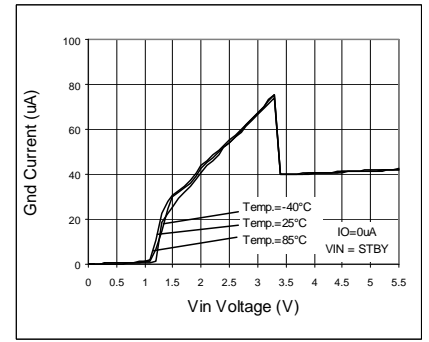

Fig. 152 Circuit Current IGND

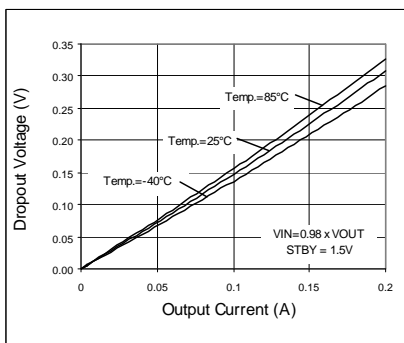

Fig. 153 Dropout Voltage

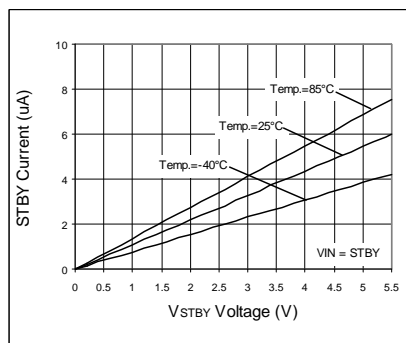

Fig. 154 STBY Input Current

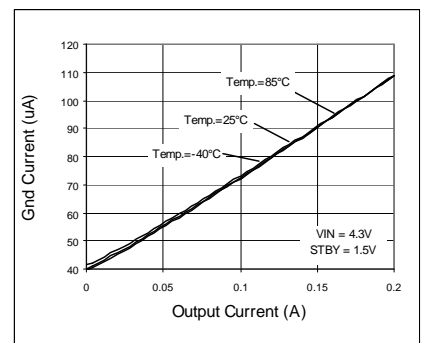

Fig. 155 IOUT - I_GND

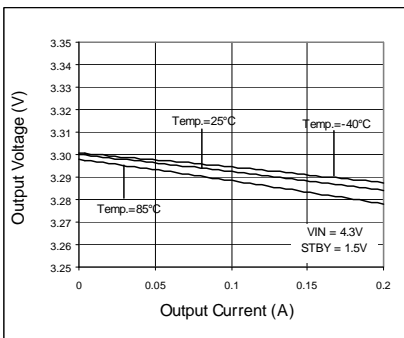

Fig. 156 Load Regulation

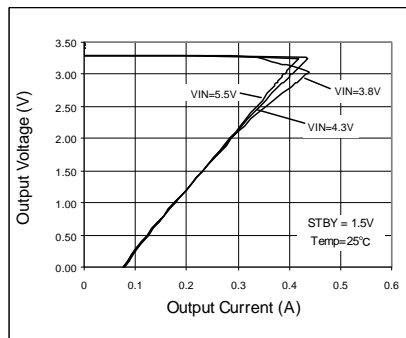

Fig. 157 OCP Threshold

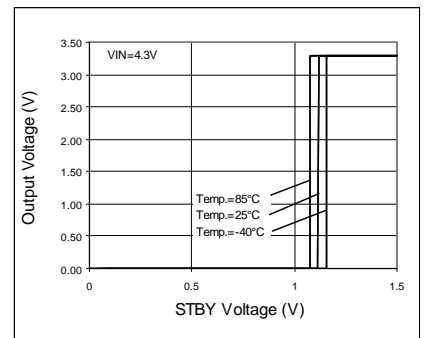

Fig. 158 STBY Threshold

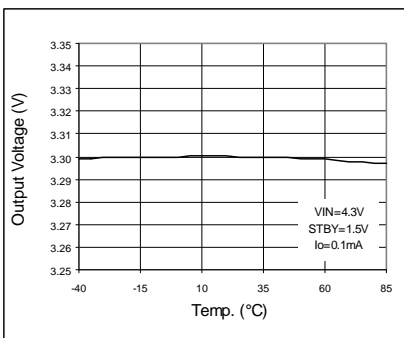

Fig. 159 VOUT vs Temp

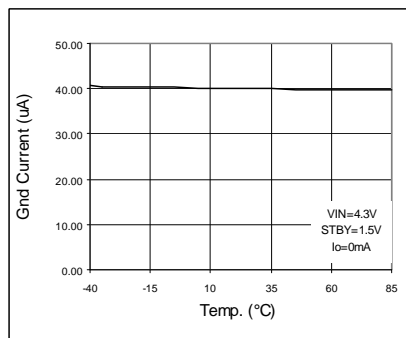

Fig. 160 IGND vs Temp

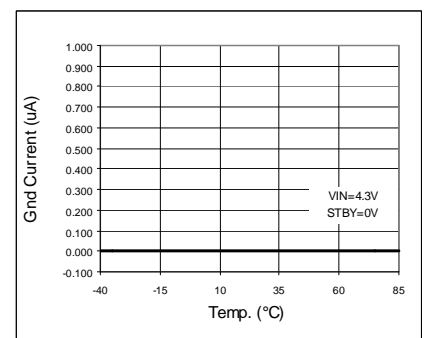

Fig. 161 IGND vs Temp (STBY)

●Reference data BU33TA2WNVX / HFV (Unless otherwise specified, Ta=25°C)

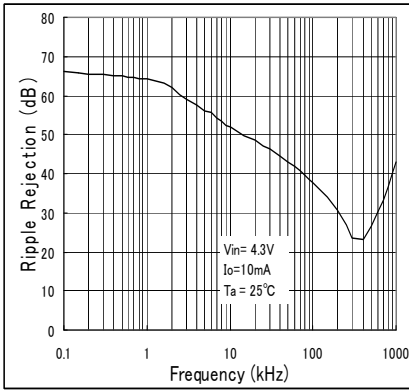

Fig. 162 Ripple Rejection VS Freq.

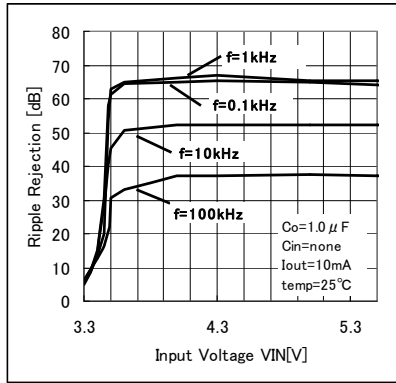

Fig. 163 Ripple Rejection VS VIN

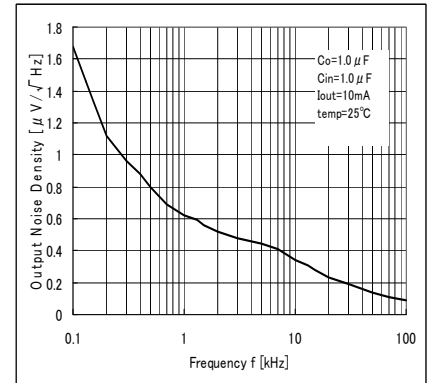

Fig. 164 Output Noise Spectral Density VS Freq.

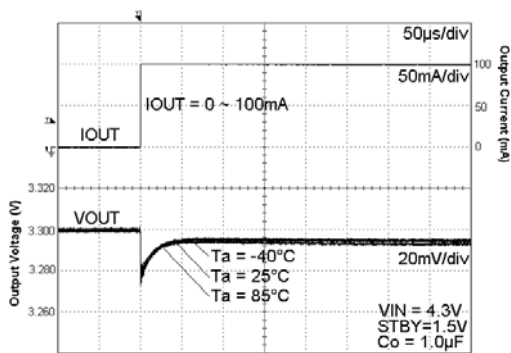

Fig. 165 Load Response

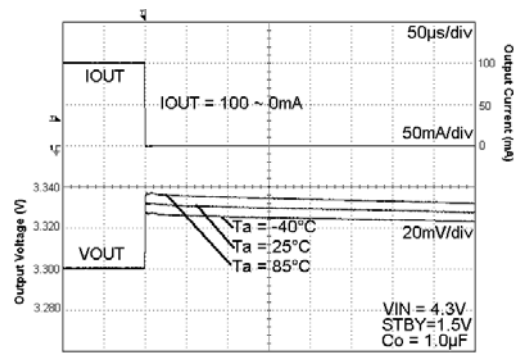

Fig. 166 Load Response

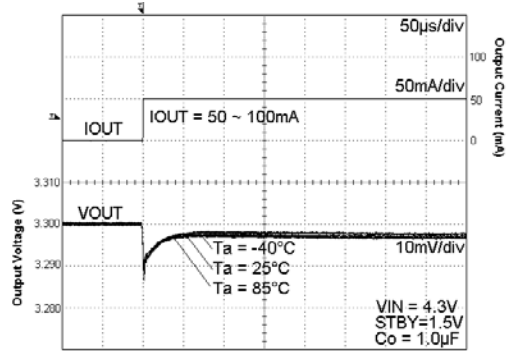

Fig. 167 Load Response

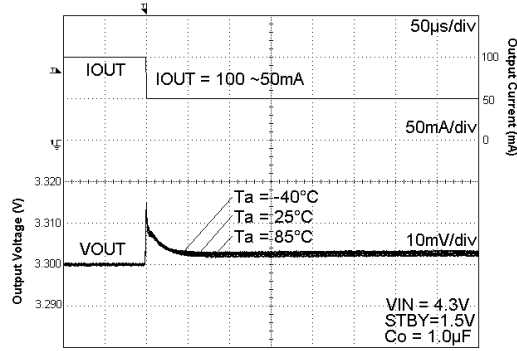

Fig. 168 Load Response

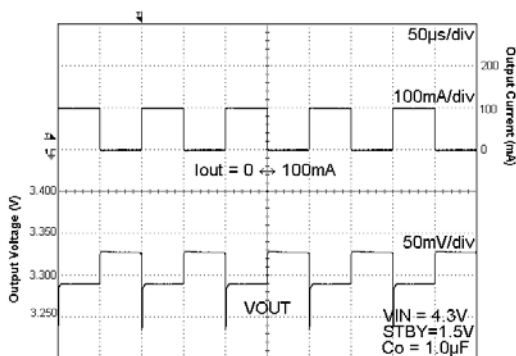

Fig. 169 Load Response
Current Pulse=10kHz

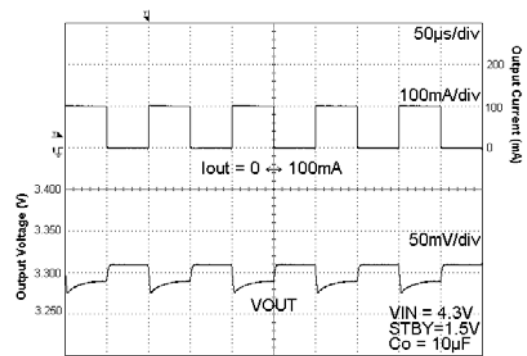

Fig. 170 Load Response
Current Pulse=10kHz

●Reference data BU33TA2WNVX / HFV (Unless otherwise specified, Ta=25°C)

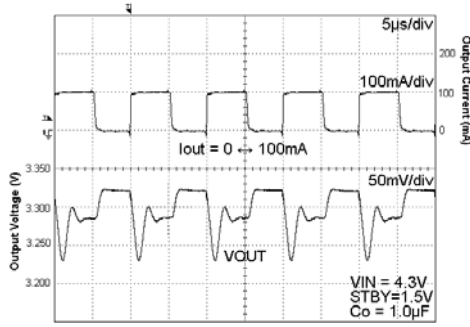

Fig. 171 Load Response
Current Pulse=100kHz

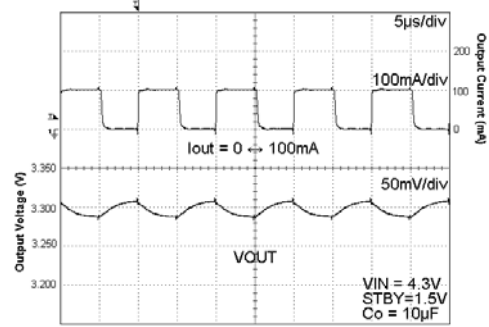

Fig. 172 Load Response
Current Pulse=100kHz

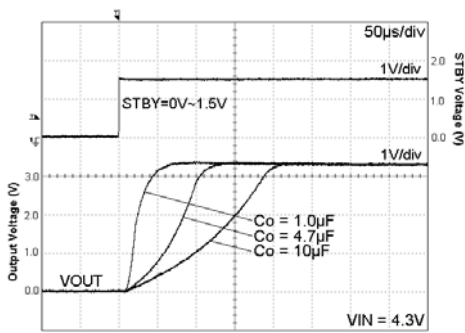

Fig. 173 Start Up Time
Iout = 0mA

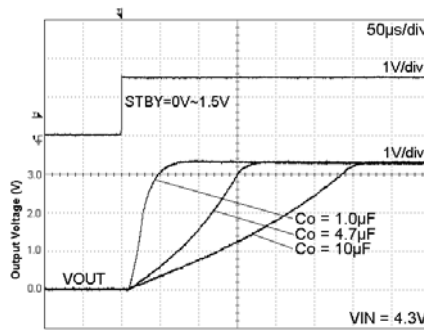

Fig. 174 Start Up Time
Iout = 200mA

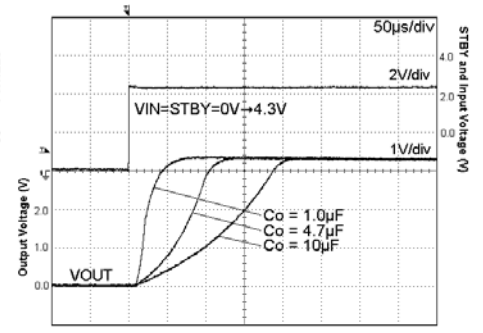

Fig. 175 Start Up Time (STBY=VIN)
Iout = 0mA

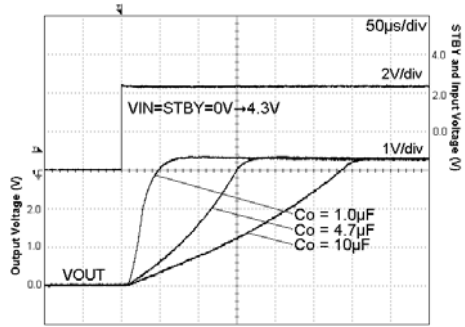

Fig. 176 Start Up Time(STBY=VIN)
Iout = 200mA

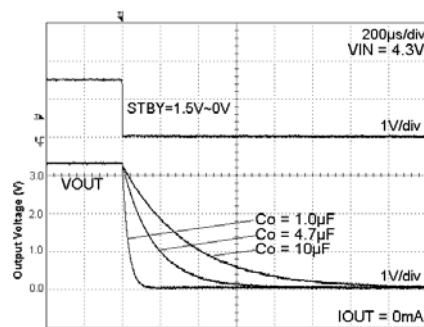

Fig. 177 Discharge Time
Iout = 0mA

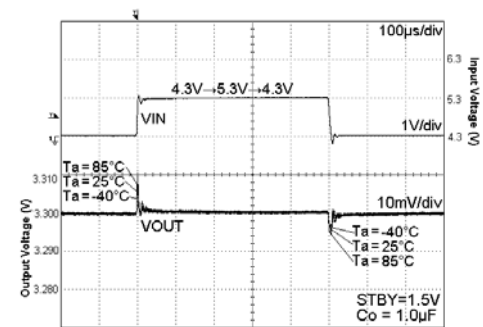

Fig. 178 VIN Response
Iout = 10mA

●About power dissipation (Pd)

As for power dissipation, an approximate estimate of the heat reduction characteristics and internal power consumption of IC are shown, so please use these for reference. Since power dissipation changes substantially depending on the implementation conditions (board size, board thickness, metal wiring rate, number of layers and through holes, etc.), it is recommended to measure Pd on a set board. Exceeding the power dissipation of IC may lead to deterioration of the original IC performance, such as causing operation of the thermal shutdown circuit or reduction in current capability. Therefore, be sure to prepare sufficient margin within power dissipation for usage.

Calculation of the maximum internal power consumption of IC (P_{MAX})

$$P_{MAX}=(V_{IN}-V_{OUT})\times I_{OUT}(MAX.)$$

(V_{IN}: Input voltage V_{OUT}: Output voltage I_{OUT}(MAX): Maximum output current)

Measurement conditions

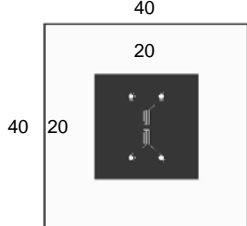
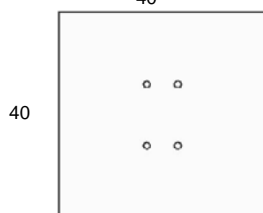
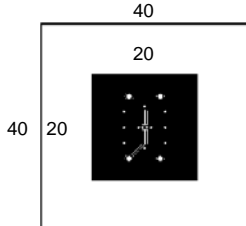
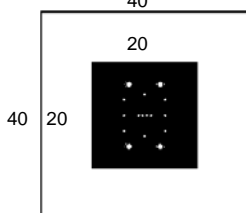
		Evaluation Board 1 (Single-side Board)	Evaluation Board 2 (Double-side Board)
Layout of Board for Measurement (Unit: mm)  IC Implementation Position		 <p>Top Layer (Top View)</p>  <p>Bottom Layer (Top View)</p>	 <p>Top Layer (Top View)</p>  <p>Bottom Layer (Top View)</p>
Measurement State		With board implemented (Wind speed 0 m/s)	With board implemented (Wind speed 0 m/s)
Board Material		Glass epoxy resin (Single-side board)	Glass epoxy resin (Double-side board)
Board Size		40 mm x 40 mm x 0.8 mm	40 mm x 40 mm x 0.8 mm
Wiring Rate	Top layer	Metal (GND) wiring rate: Approx. 25%	Metal (GND) wiring rate: Approx. 25%
	Bottom layer	Metal (GND) wiring rate: Approx 0%	Metal (GND) wiring rate: Approx 25%
Through Hole		0 holes	Diameter 0.5 mm x 12 holes
Power Dissipation		1100 mW	1250 mW
Thermal Resistance		θ _{ja} =91°C/W	θ _{ja} =80°C/W

OSSON004X1216

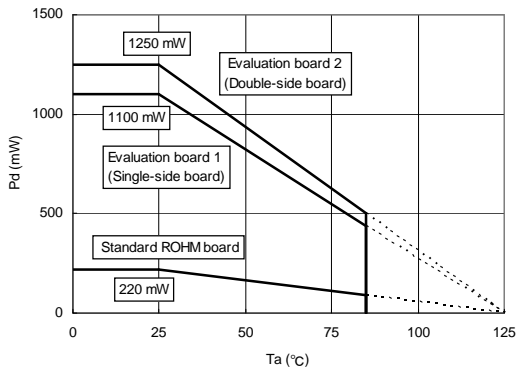

* Please design the margin so that P_{MAX} becomes is than Pd (P_{MAX}<Pd) within the usage temperature range.

- Standard ROHM board -
Size: 70 mm × 70 mm × 1.6 mm
Material: Glass epoxy board

Fig.179 OSSON004X1216
Power dissipation heat reduction characteristics
(Reference)

OHVSOF5

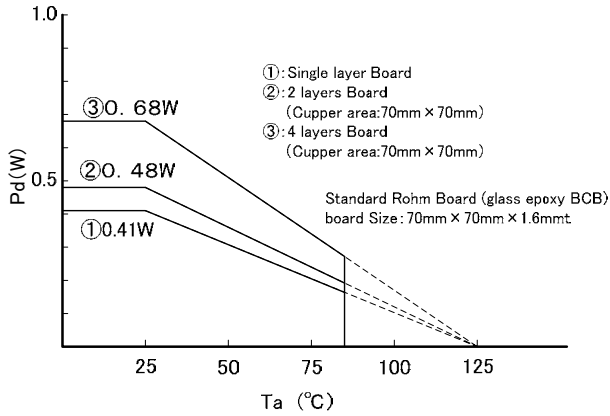

* Please design the margin so that P_{MAX} becomes is than Pd (P_{MAX}<Pd) within the usage temperature range.

Fig.180 HVSO5
Power dissipation heat reduction characteristics
(Reference)

●DEVICE TYPE & Mark

OSSON004X1216

OHVSOF5

Device type: BUXXTA2WNVX

Device type: BUXXTA2WHFV

↑
a

↑
a

	XX	output voltage	package	
			SSON004X1216	HVSOF5
a	15	1.5V typ.	AA	BA
	18	1.8V typ.	AB	BB
	25	2.5V typ.	AC	BD
	26	2.6V typ.	AD	BE
	27	2.7V typ.	AE	BF
	28	2.8V typ.	AF	BG
	2J	2.85V typ.	AG	BH
	29	2.9V typ.	AH	BJ
	30	3.0V typ.	AJ	BK
	31	3.1V typ.	AK	BL
	32	3.2V typ.	AL	BM
	33	3.3V typ.	AM	BN
	34	3.4V typ.	AN	BP

OSSON004X1216

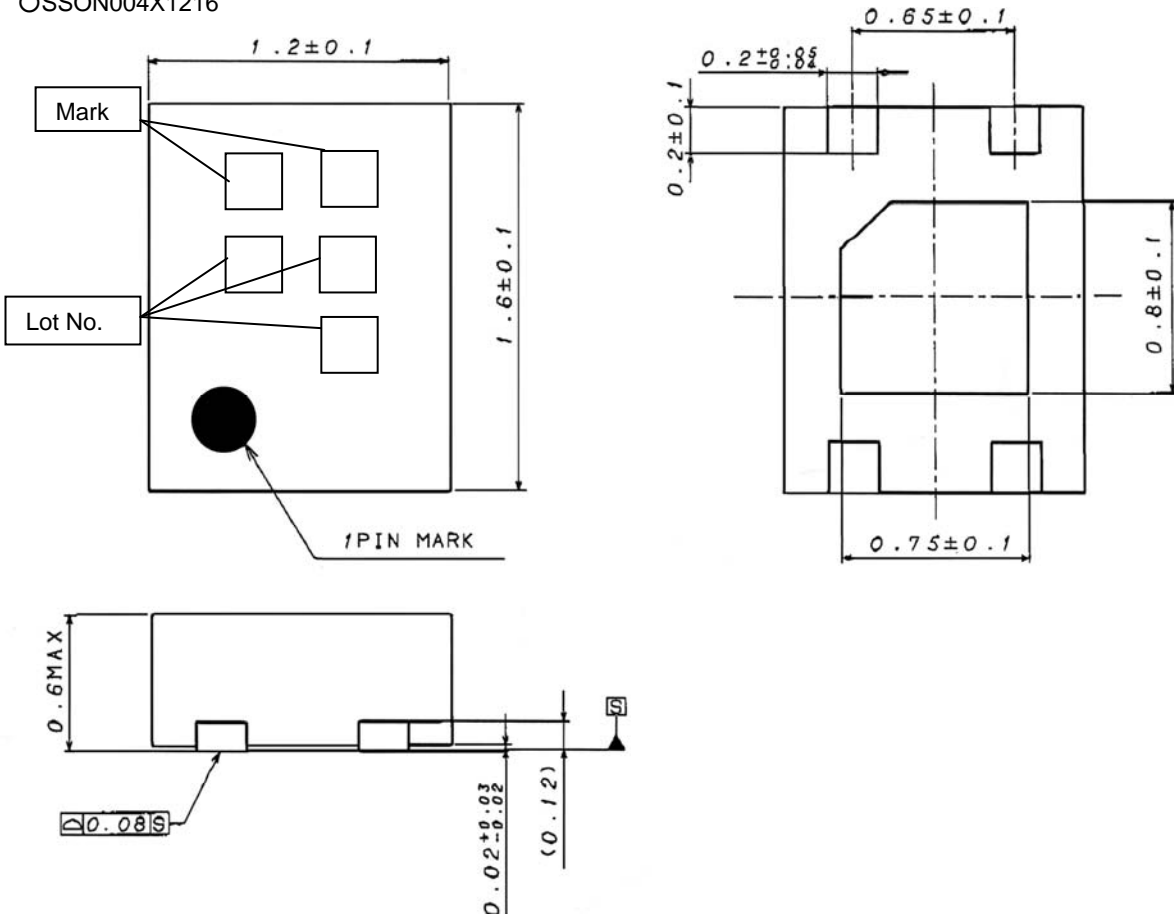

OHVSOF5

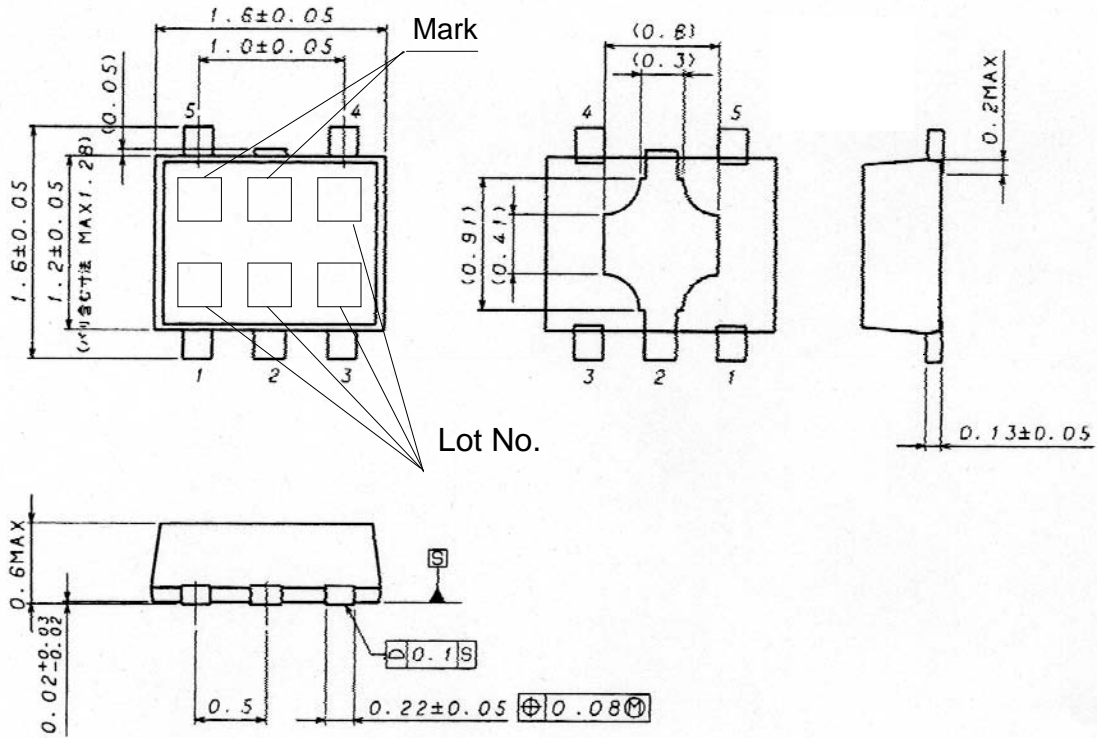

●Notes for use

- About absolute maximum rating
Breakage may occur when absolute maximum ratings such as applied voltage and operating temperature range are exceeded. Short mode or open mode cannot be specified at occurrence of a break, so please prepare physical safety measures (e.g., fuse) if such special mode in which the absolute maximum rating is exceeded can be assumed.
- About GND potential
Please be sure that the potential of the GND terminal is the lowest in any operating condition.
- About thermal design
Please provide thermal design with sufficient margin, taking power dissipation (Pd) in actual usage conditions into consideration.
- About short between pins and misattachment
Please be careful regarding the IC direction and misalignment at attachment onto a printed circuit board. Misattachment may cause a break of IC. Short caused by foreign matter between outputs, output and power supply, or GNDs may also lead to a break.
- About operation in a strong electromagnetic field
Please note that usage in a strong electromagnetic field may cause malfunction.
- About common impedance
Please give due consideration to wiring of the power source and GND by reducing common-mode ripple or making ripple as small as possible (e.g., making the wiring as thick and short as possible, or reducing ripple by L-C), etc.
- About STBY terminal voltage
Set STBY terminal voltage to 0.3 V or less to put each channel into a standby state and to 1.5 V or more to put each channel into an operating state. Do not fix STBY terminal voltage to 0.3 V or more and 1.5 V or less or do not lengthen the transition time. This may cause malfunction or failure. When shorting the VIN terminal and STBY terminal for usage, the status will be "STBY=VIN=LOW" at turning the power OFF, and discharge of the VOUT terminal cannot operate, which means voltage may remain for a certain time in the VOUT terminal. Since turning the power ON again in this state may cause overshoot, turn the power ON for use after the VOUT terminal is completely discharged.
- About overcurrent protection circuit
Output has a built-in overcurrent protection circuit, which prevents IC break at load short. Note that this protection circuit is effective for prevention of breaks due to unexpected accidents. Please avoid usage by which the protection circuit operates continuously.
- About thermal shutdown
Output is OFF when the thermal circuit operates since a temperature protection circuit is built in to prevent thermal breakdown. However, it recovers when the temperature returns to a certain temperature. The thermal circuit operates at emergency such as overheating of IC. Since it is prepared to prevent IC breakdown, please do not use it in a state in which protection works.

●About reverse current

For applications on which reverse current is assumed to flow into IC, it is recommended to prepare a path to let the current out by putting a bypass diode between the VIN-VOUT terminals.

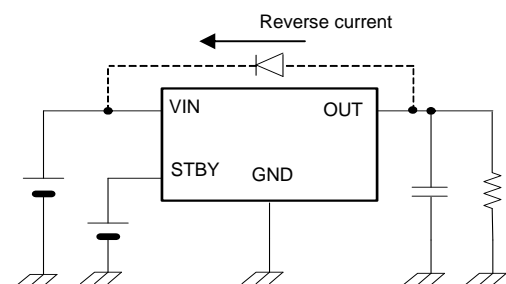

Fig.181 Example of bypass diode connection

●About testing on a set board

When connecting a capacitor to a terminal with low impedance for testing on a set board, please be sure to discharge for each process since IC may be stressed. As a countermeasure against static electricity, prepare grounding in the assembly process and take sufficient care in transportation and storage. In addition, when connecting a capacitor to a jig in a testing process, please do so after turning the power OFF and remove it after turning the power OFF.

●Ordering part number

B	U	1	5	T	A	2	W	N	V	X	-	T	R
Part No.		Output voltage 15: 1.5V 29: 2.9V 18: 1.8V 30: 3.0V 25: 2.5V 31: 3.1V 26: 2.6V 32: 3.2V 27: 2.7V 33: 3.3V 28: 2.8V 34: 3.4V 2J: 2.85V			Lineup			Shutdown Switch W : Includes switch	Package NVX : SSON004X1216 HFV : HVSO5F5			Packaging and forming specification TR: Embossed tape and reel	

SSON004X1216

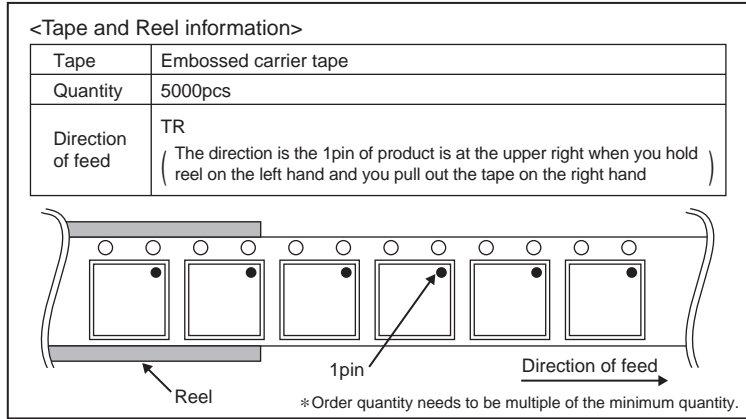
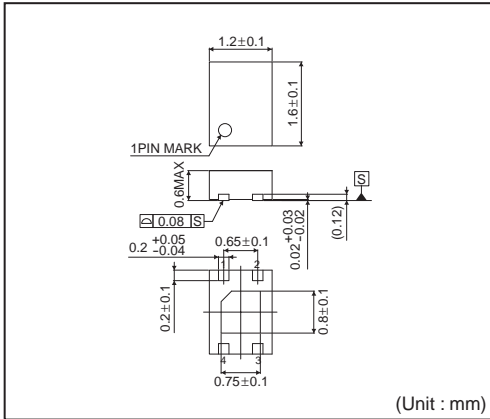

HVSO5F5

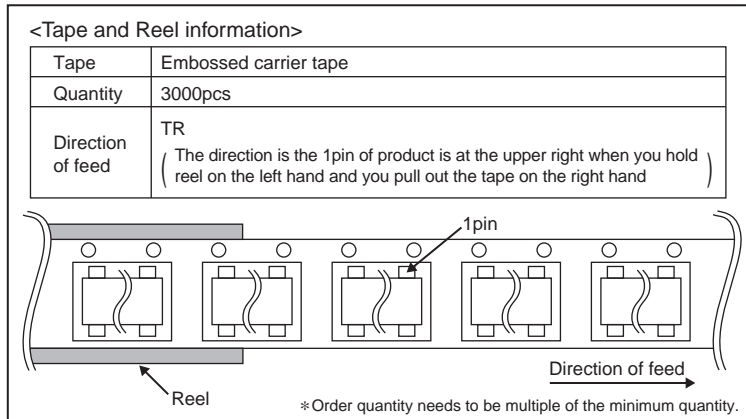
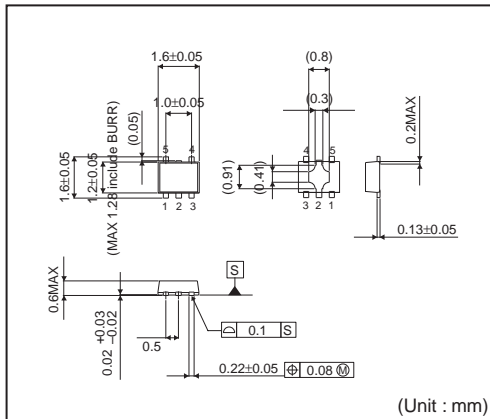

Notice

Precaution on using ROHM Products

- Our Products are designed and manufactured for application in ordinary electronic equipments (such as AV equipment, OA equipment, telecommunication equipment, home electronic appliances, amusement equipment, etc.). If you intend to use our Products in devices requiring extremely high reliability (such as medical equipment ^(Note 1), transport equipment, traffic equipment, aircraft/spacecraft, nuclear power controllers, fuel controllers, car equipment including car accessories, safety devices, etc.) and whose malfunction or failure may cause loss of human life, bodily injury or serious damage to property ("Specific Applications"), please consult with the ROHM sales representative in advance. Unless otherwise agreed in writing by ROHM in advance, ROHM shall not be in any way responsible or liable for any damages, expenses or losses incurred by you or third parties arising from the use of any ROHM's Products for Specific Applications.

(Note1) Medical Equipment Classification of the Specific Applications

JAPAN	USA	EU	CHINA
CLASS III	CLASS III	CLASS II b	CLASS III
CLASS IV		CLASS III	

- ROHM designs and manufactures its Products subject to strict quality control system. However, semiconductor products can fail or malfunction at a certain rate. Please be sure to implement, at your own responsibilities, adequate safety measures including but not limited to fail-safe design against the physical injury, damage to any property, which a failure or malfunction of our Products may cause. The following are examples of safety measures:
 - Installation of protection circuits or other protective devices to improve system safety
 - Installation of redundant circuits to reduce the impact of single or multiple circuit failure
- Our Products are designed and manufactured for use under standard conditions and not under any special or extraordinary environments or conditions, as exemplified below. Accordingly, ROHM shall not be in any way responsible or liable for any damages, expenses or losses arising from the use of any ROHM's Products under any special or extraordinary environments or conditions. If you intend to use our Products under any special or extraordinary environments or conditions (as exemplified below), your independent verification and confirmation of product performance, reliability, etc. prior to use, must be necessary:
 - Use of our Products in any types of liquid, including water, oils, chemicals, and organic solvents
 - Use of our Products outdoors or in places where the Products are exposed to direct sunlight or dust
 - Use of our Products in places where the Products are exposed to sea wind or corrosive gases, including Cl₂, H₂S, NH₃, SO₂, and NO₂
 - Use of our Products in places where the Products are exposed to static electricity or electromagnetic waves
 - Use of our Products in proximity to heat-producing components, plastic cords, or other flammable items
 - Sealing or coating our Products with resin or other coating materials
 - Use of our Products without cleaning residue of flux (even if you use no-clean type fluxes, cleaning residue of flux is recommended); or Washing our Products by using water or water-soluble cleaning agents for cleaning residue after soldering
 - Use of the Products in places subject to dew condensation
- The Products are not subject to radiation-proof design.
- Please verify and confirm characteristics of the final or mounted products in using the Products.
- In particular, if a transient load (a large amount of load applied in a short period of time, such as pulse. is applied, confirmation of performance characteristics after on-board mounting is strongly recommended. Avoid applying power exceeding normal rated power; exceeding the power rating under steady-state loading condition may negatively affect product performance and reliability.
- De-rate Power Dissipation (Pd) depending on Ambient temperature (Ta). When used in sealed area, confirm the actual ambient temperature.
- Confirm that operation temperature is within the specified range described in the product specification.
- ROHM shall not be in any way responsible or liable for failure induced under deviant condition from what is defined in this document.

Precaution for Mounting / Circuit board design

- When a highly active halogenous (chlorine, bromine, etc.) flux is used, the residue of flux may negatively affect product performance and reliability.
- In principle, the reflow soldering method must be used; if flow soldering method is preferred, please consult with the ROHM representative in advance.

For details, please refer to ROHM Mounting specification

Precautions Regarding Application Examples and External Circuits

1. If change is made to the constant of an external circuit, please allow a sufficient margin considering variations of the characteristics of the Products and external components, including transient characteristics, as well as static characteristics.
2. You agree that application notes, reference designs, and associated data and information contained in this document are presented only as guidance for Products use. Therefore, in case you use such information, you are solely responsible for it and you must exercise your own independent verification and judgment in the use of such information contained in this document. ROHM shall not be in any way responsible or liable for any damages, expenses or losses incurred by you or third parties arising from the use of such information.

Precaution for Electrostatic

This Product is electrostatic sensitive product, which may be damaged due to electrostatic discharge. Please take proper caution in your manufacturing process and storage so that voltage exceeding the Products maximum rating will not be applied to Products. Please take special care under dry condition (e.g. Grounding of human body / equipment / solder iron, isolation from charged objects, setting of ionizer, friction prevention and temperature / humidity control).

Precaution for Storage / Transportation

1. Product performance and soldered connections may deteriorate if the Products are stored in the places where:
 - [a] the Products are exposed to sea winds or corrosive gases, including Cl₂, H₂S, NH₃, SO₂, and NO₂
 - [b] the temperature or humidity exceeds those recommended by ROHM
 - [c] the Products are exposed to direct sunshine or condensation
 - [d] the Products are exposed to high Electrostatic
2. Even under ROHM recommended storage condition, solderability of products out of recommended storage time period may be degraded. It is strongly recommended to confirm solderability before using Products of which storage time is exceeding the recommended storage time period.
3. Store / transport cartons in the correct direction, which is indicated on a carton with a symbol. Otherwise bent leads may occur due to excessive stress applied when dropping of a carton.
4. Use Products within the specified time after opening a humidity barrier bag. Baking is required before using Products of which storage time is exceeding the recommended storage time period.

Precaution for Product Label

QR code printed on ROHM Products label is for ROHM's internal use only.

Precaution for Disposition

When disposing Products please dispose them properly using an authorized industry waste company.

Precaution for Foreign Exchange and Foreign Trade act

Since our Products might fall under controlled goods prescribed by the applicable foreign exchange and foreign trade act, please consult with ROHM representative in case of export.

Precaution Regarding Intellectual Property Rights

1. All information and data including but not limited to application example contained in this document is for reference only. ROHM does not warrant that foregoing information or data will not infringe any intellectual property rights or any other rights of any third party regarding such information or data. ROHM shall not be in any way responsible or liable for infringement of any intellectual property rights or other damages arising from use of such information or data.:
2. No license, expressly or implied, is granted hereby under any intellectual property rights or other rights of ROHM or any third parties with respect to the information contained in this document.

Other Precaution

1. This document may not be reprinted or reproduced, in whole or in part, without prior written consent of ROHM.
2. The Products may not be disassembled, converted, modified, reproduced or otherwise changed without prior written consent of ROHM.
3. In no event shall you use in any way whatsoever the Products and the related technical information contained in the Products or this document for any military purposes, including but not limited to, the development of mass-destruction weapons.
4. The proper names of companies or products described in this document are trademarks or registered trademarks of ROHM, its affiliated companies or third parties.

General Precaution

1. Before you use our Products, you are requested to carefully read this document and fully understand its contents. ROHM shall not be in any way responsible or liable for failure, malfunction or accident arising from the use of any ROHM's Products against warning, caution or note contained in this document.
2. All information contained in this document is current as of the issuing date and subject to change without any prior notice. Before purchasing or using ROHM's Products, please confirm the latest information with a ROHM sales representative.
3. The information contained in this document is provided on an "as is" basis and ROHM does not warrant that all information contained in this document is accurate and/or error-free. ROHM shall not be in any way responsible or liable for any damages, expenses or losses incurred by you or third parties resulting from inaccuracy or errors of or concerning such information.



BU30TA2WHFV - Web Page

[Distribution Inventory](#)

Part Number	BU30TA2WHFV
Package	HVSOF5
Unit Quantity	3000
Minimum Package Quantity	3000
Packing Type	Taping
Constitution Materials List	inquiry
RoHS	Yes