

Low $V_{CE(sat)}$
High speed IGBT

IXGH/IXGM 25 N100
IXGH/IXGM 25 N100A

V_{CES}	I_{C25}	$V_{CE(sat)}$
1000 V	50 A	3.5 V
1000 V	50 A	4.0 V

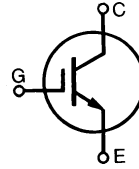

Symbol	Test Conditions	Maximum Ratings	
V_{CES}	$T_J = 25^\circ\text{C}$ to 150°C	1000	V
V_{CGR}	$T_J = 25^\circ\text{C}$ to 150°C ; $R_{GE} = 1\text{ M}\Omega$	1000	V
V_{GES}	Continuous	± 20	V
V_{GEM}	Transient	± 30	V
I_{C25}	$T_C = 25^\circ\text{C}$	50	A
I_{C90}	$T_C = 90^\circ\text{C}$	25	A
I_{CM}	$T_C = 25^\circ\text{C}$, 1 ms	100	A
SSOA (RBSOA)	$V_{GE} = 15\text{ V}$, $T_{VJ} = 125^\circ\text{C}$, $R_G = 33\ \Omega$ Clamped inductive load, $L = 100\ \mu\text{H}$	$I_{CM} = 50$ @ $0.8\ V_{CES}$	A
P_c	$T_C = 25^\circ\text{C}$	200	W
T_J		-55 ... +150	$^\circ\text{C}$
T_{JM}		150	$^\circ\text{C}$
T_{stg}		-55 ... +150	$^\circ\text{C}$
M_d	Mounting torque (M3)	1.13/10 Nm/lb.in.	
Weight		TO-204 = 18 g, TO-247 = 6 g	
Maximum lead temperature for soldering 1.6 mm (0.062 in.) from case for 10 s		300	$^\circ\text{C}$

TO-247 AD (IXGH)

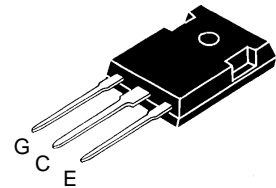

TO-204 AE (IXGM)

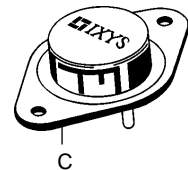

G = Gate, C = Collector,
E = Emitter, TAB = Collector

Features

- International standard packages
- 2nd generation HDMOS™ process
- Low $V_{CE(sat)}$
 - for low on-state conduction losses
- High current handling capability
- MOS Gate turn-on
 - drive simplicity
- Voltage rating guaranteed at high temperature (125°C)

Applications

- AC motor speed control
- DC servo and robot drives
- DC choppers
- Uninterruptible power supplies (UPS)
- Switch-mode and resonant-mode power supplies

Advantages

- Easy to mount with 1 screw (TO-247) (isolated mounting screw hole)
- High power density

Symbol	Test Conditions	Characteristic Values ($T_J = 25^\circ\text{C}$, unless otherwise specified)		
		min.	typ.	max.
BV_{CES}	$I_C = 3\text{ mA}$, $V_{GE} = 0\text{ V}$	1000		V
$V_{GE(th)}$	$I_C = 250\ \mu\text{A}$, $V_{CE} = V_{GE}$	2.5		5 V
I_{CES}	$V_{CE} = 0.8 \cdot V_{CES}$ $V_{GE} = 0\text{ V}$			$T_J = 25^\circ\text{C}$: 250 μA $T_J = 125^\circ\text{C}$: 1 mA
I_{GES}	$V_{CE} = 0\text{ V}$, $V_{GE} = \pm 20\text{ V}$			$\pm 100\text{ nA}$
$V_{CE(sat)}$	$I_C = I_{C90}$, $V_{GE} = 15\text{ V}$			25N100: 3.5 V 25N100A: 4.0 V

Symbol	Test Conditions	Characteristic Values ($T_J = 25^\circ\text{C}$, unless otherwise specified)		
		min.	typ.	max.
g_{fs}	$I_C = I_{C90}$; $V_{CE} = 10\text{ V}$, Pulse test, $t \leq 300\ \mu\text{s}$, duty cycle $\leq 2\%$	8	15	S
C_{ies}	$V_{CE} = 25\text{ V}$, $V_{GE} = 0\text{ V}$, $f = 1\text{ MHz}$		2750	pF
C_{oes}			200	pF
C_{res}			50	pF
Q_g	$I_C = I_{C90}$, $V_{GE} = 15\text{ V}$, $V_{CE} = 0.5 V_{CES}$		130	180 nC
Q_{ge}			25	60 nC
Q_{gc}			55	90 nC
$t_{d(on)}$	Inductive load, $T_J = 25^\circ\text{C}$ $I_C = I_{C90}$, $V_{GE} = 15\text{ V}$, $L = 300\ \mu\text{H}$, $V_{CE} = 0.8 V_{CES}$, $R_G = R_{off} = 33\ \Omega$ Remarks: Switching times may increase for $V_{CE}(\text{Clamp}) > 0.8 \cdot V_{CES}$, higher T_J or increased R_G		100	ns
t_{ri}			200	ns
$t_{d(off)}$			500	ns
t_{fi}		25N100A	500	ns
E_{off}		25N100A	5	mJ
$t_{d(on)}$	Inductive load, $T_J = 125^\circ\text{C}$ $I_C = I_{C90}$, $V_{GE} = 15\text{ V}$, $L = 300\ \mu\text{H}$, $V_{CE} = 0.8 V_{CES}$, $R_G = R_{off} = 33\ \Omega$ Remarks: Switching times may increase for $V_{CE}(\text{Clamp}) > 0.8 \cdot V_{CES}$, higher T_J or increased R_G		100	ns
t_{ri}			250	ns
E_{on}			3.5	mJ
$t_{d(off)}$		25N100	720	1000 ns
t_{fi}		25N100A	950	3000 ns
E_{off}	25N100	10	mJ	
	25N100A	8	mJ	
R_{thJC}				0.62 K/W
R_{thCK}		0.25		K/W

TO-247 AD Outline

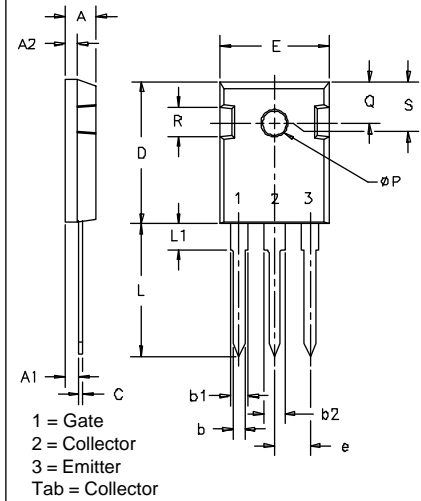

SYM	INCHES		MILLIMETERS	
	MIN	MAX	MIN	MAX
A	.185	.209	4.7	5.3
A1	.087	.102	2.2	2.54
A2	.059	.098	2.2	2.6
b	.040	.055	1.0	1.4
b1	.065	.084	1.65	2.13
b2	.113	.123	2.87	3.12
C	.016	.031	.4	.8
D	.819	.845	20.80	21.46
E	.610	.640	15.75	16.26
e	.215 BSC		5.45 BSC	
L	.780	.800	19.81	20.32
L1		.177		4.50
ϕP	.140	.144	3.55	3.65
Q	.212	.244	5.4	6.2
R	.170	.216	4.32	5.49
S		.242 BSC		6.15 BSC

TO-204AE Outline

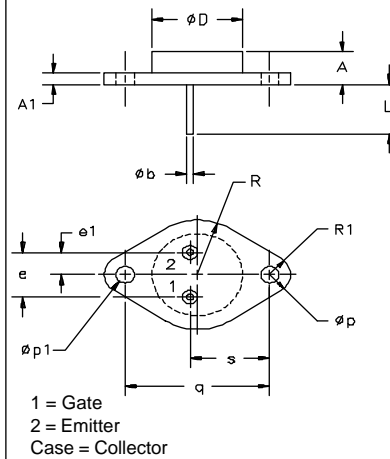

SYM	INCHES		MILLIMETERS	
	MIN	MAX	MIN	MAX
A	.250	.450	6.4	11.4
A1	.060	.135	1.53	3.42
ϕb	.057	.063	1.45	1.60
ϕD		.875		22.22
e	.420	.440	10.67	11.17
e1	.205	.225	5.21	5.71
L	.440	.480	11.18	12.19
ϕp	.151	.165	3.84	4.19
$\phi p1$.151	.165	3.84	4.19
q	1.187 BSC		30.15 BSC	
R	.495	.525	12.58	13.33
R1	.131	.188	3.33	4.77
s	.655	.675	16.64	17.14

IXYS reserves the right to change limits, test conditions, and dimensions.

IXYS MOSFETS and IGBTs are covered by one or more of the following U.S. patents: 4,835,592 4,881,106 5,017,508 5,049,961 5,187,117 5,486,715
 4,850,072 4,931,844 5,034,796 5,063,307 5,237,481 5,381,025

Fig. 1 Saturation Characteristics

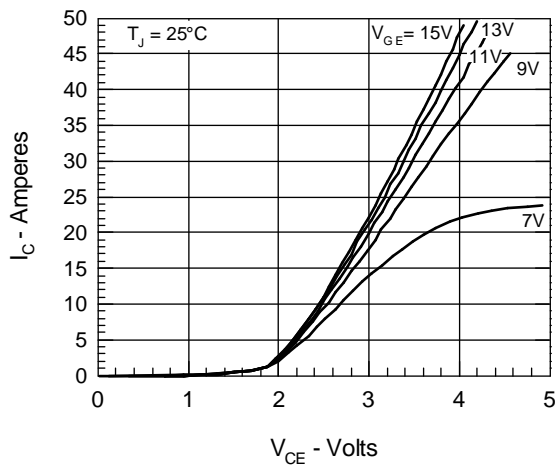

Fig. 2 Output Characteristics

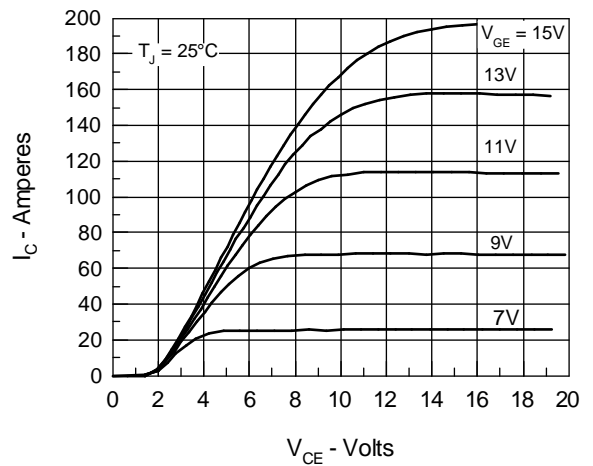

Fig. 3 Collector-Emitter Voltage vs. Gate-Emitter Voltage

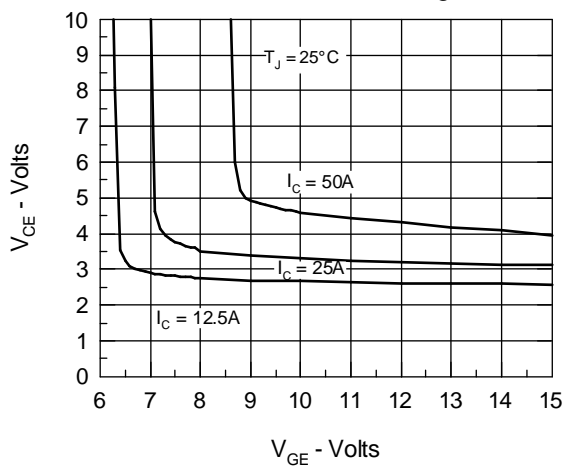

Fig. 4 Temperature Dependence of Output Saturation Voltage

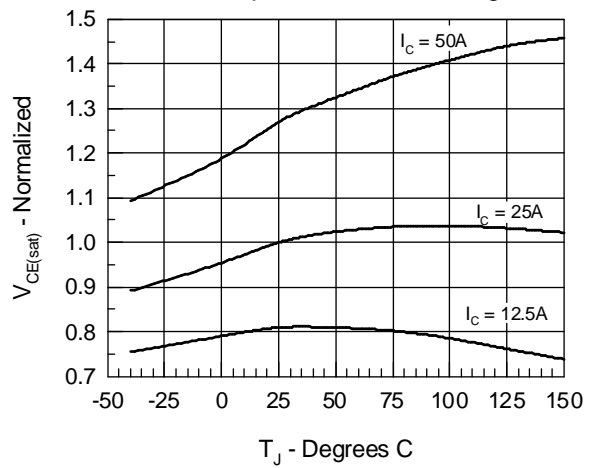

Fig. 5 Input Admittance

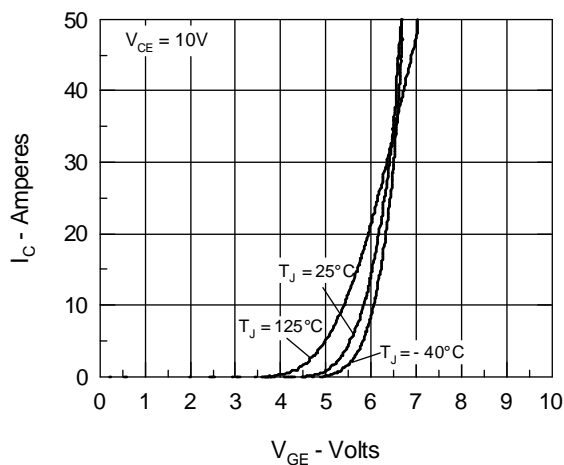

Fig. 6 Temperature Dependence of Breakdown and Threshold Voltage

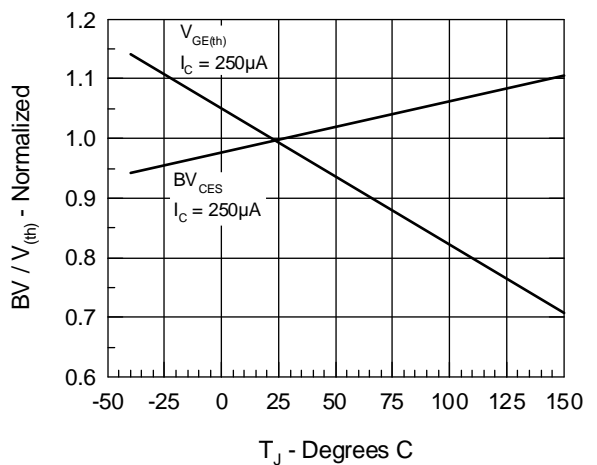

Fig.7 Gate Charge

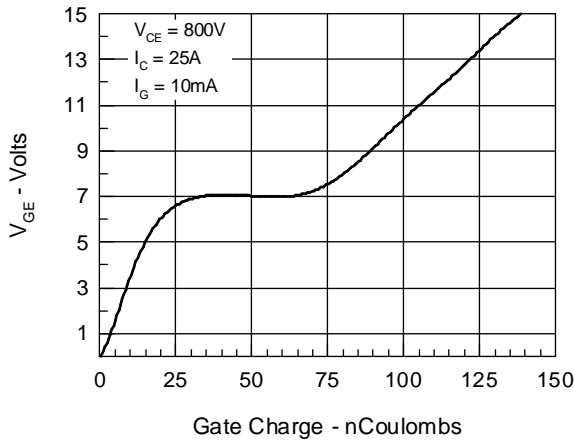

Fig.8 Turn-Off Safe Operating Area

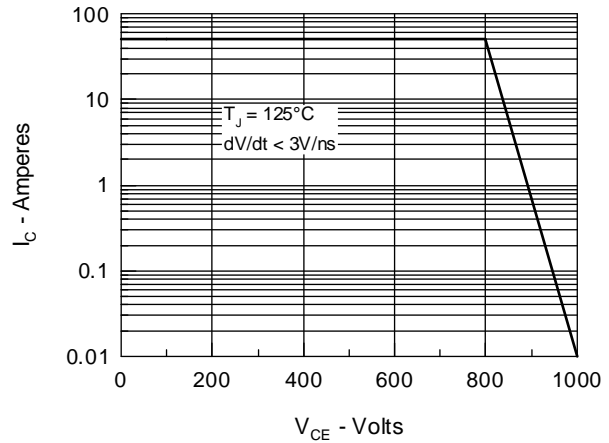

Fig.9 Capacitance Curves

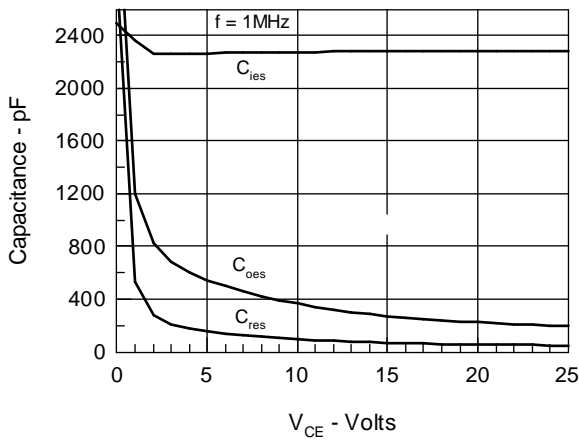
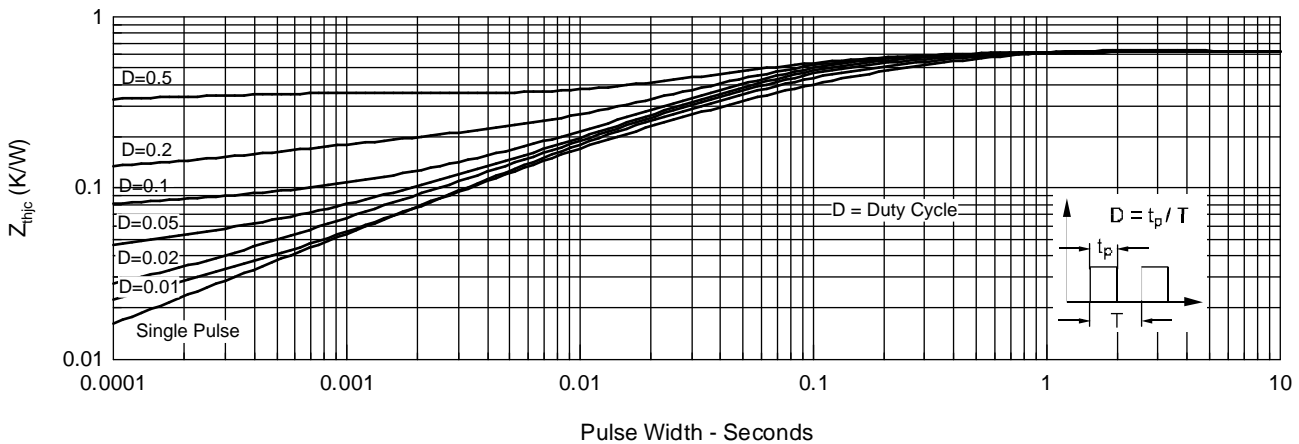

Fig.10 Transient Thermal Impedance



IXYS reserves the right to change limits, test conditions, and dimensions.

IXYS MOSFETS and IGBTs are covered by one or more of the following U.S. patents: 4,835,592 4,881,106 5,017,508 5,049,961 5,187,117 5,486,715
4,850,072 4,931,844 5,034,796 5,063,307 5,237,481 5,381,025