

1 2 3 4 5 6

A

B

C

D

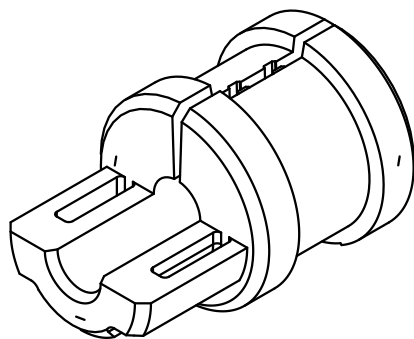
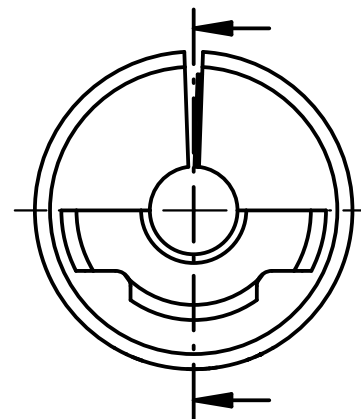
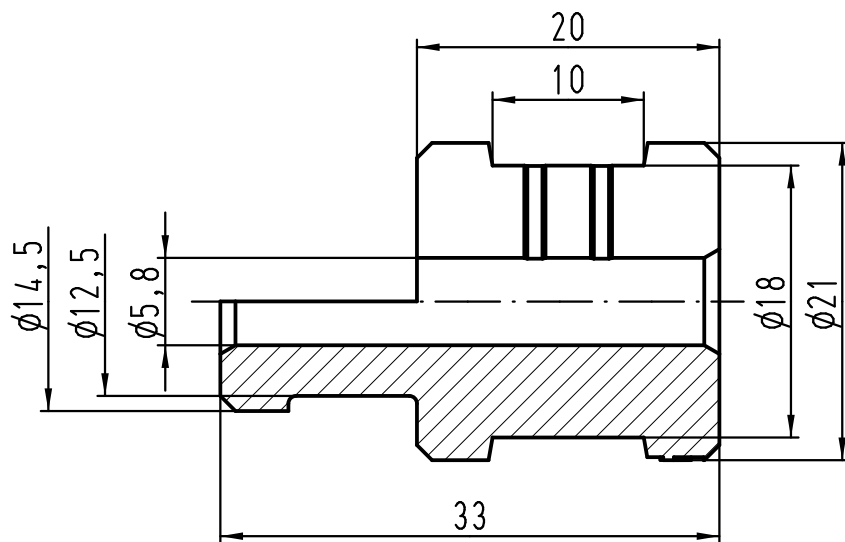

verwendbarer Kabel- $\phi$  5-6mm  
suitable cable  $\phi$  5-6mm

All Dimensions in mm Original Size DIN A 4		Techn. Character.			Nicht tolerierte Maß/Free size tolerances	
			Dat.	Name	Maßstab/Scale <b>2:1</b>	Kabeldurchführungstülle <i>Cable entry gland</i>
		Detail.	07.03.12	Ho		
		Insp.		Be		
		Stand.				
A			HARTING Electric GmbH & Co. KG		TB 09 00 000 5353	Blatt/page
Mod.	Dat.	Name	D-32339 Espelkamp			