

**SANYO Semiconductors**

# DATA SHEET

An ON Semiconductor Company

## LV5027M — Bi-CMOS IC LED Driver IC

### Overview

LV5027M is a High Voltage LED drive controller which drives LED current up to 3A with external MOSFET.  
LV5027M is realized very simple LED circuits with a few external parts.

### Functions

- High Voltage LED Controller
- Low noise switching system
  - 5 stages skip mode Frequency
  - Soft driving
- Built-in Reference voltage circuit (internal 0.605V)
- Built-in circuit of detection of overvoltage of CS pin.
- Short Protection Circuit

### Specifications

**Maximum Ratings** at Ta = 25°C

Parameter	Symbol	Conditions	Ratings	Unit
Maximum Input voltage	V <sub>IN</sub> max		-0.3 to 42	V
CS pin			-0.3 to 7	V
OUT pin	V <sub>OUT_abs</sub>		-0.3 to 42	V
Allowable power dissipation	P <sub>d</sub> max	With specified board*	1.0	W
Junction temperature	T <sub>j</sub> max		150	°C
Operating temperature	T <sub>opr</sub>		-30 to +125	°C
Storage temperature	T <sub>stg</sub>		-40 to +150	°C

\*Specified board: 58.0×54.0×1.6mm (glass epoxy board)

■ Any and all SANYO Semiconductor Co.,Ltd. products described or contained herein are, with regard to "standard application", intended for the use as general electronics equipment (home appliances, AV equipment, communication device, office equipment, industrial equipment etc.). The products mentioned herein shall not be intended for use for any "special application" (medical equipment whose purpose is to sustain life, aerospace instrument, nuclear control device, burning appliances, transportation machine, traffic signal system, safety equipment etc.) that shall require extremely high level of reliability and can directly threaten human lives in case of failure or malfunction of the product or may cause harm to human bodies, nor shall they grant any guarantee thereof. If you should intend to use our products for applications outside the standard applications of our customer who is considering such use and/or outside the scope of our intended standard applications, please consult with us prior to the intended use. If there is no consultation or inquiry before the intended use, our customer shall be solely responsible for the use.

■ Specifications of any and all SANYO Semiconductor Co.,Ltd. products described or contained herein stipulate the performance, characteristics, and functions of the described products in the independent state, and are not guarantees of the performance, characteristics, and functions of the described products as mounted in the customer's products or equipment. To verify symptoms and states that cannot be evaluated in an independent device, the customer should always evaluate and test devices mounted in the customer's products or equipment.

**SANYO Semiconductor Co., Ltd.**
<http://semicon.sanyo.com/en/network>

# LV5027M

## Recommended Operating Conditions at Ta = 25°C

Parameter	Symbol	Conditions	Ratings	Unit
Input voltage	V <sub>IN</sub>		8.5 to 24	V

## Electrical Characteristics at Ta = 25°C, V<sub>IN</sub> = 12V, unless otherwise specified.

Parameter	Symbol	Conditions	Ratings			Unit
			min	typ	max	
<b>Reference Voltage block</b>						
Built-in Reference Voltage	VREF		0.585	0.605	0.625	V
VREF V <sub>IN</sub> line regulation	VREF_LN	V <sub>IN</sub> = 8.5 to 24V		±0.5		%
<b>Under Voltage Lockout</b>						
Operation Start Input Voltage	UVLOON		8	9	10	V
Operation Stop Input Voltage	UVLOOFF		6.3	7.3	8.3	V
Hysteresis Voltage	UVLOH			1.7		V
<b>Oscillation</b>						
Frequency	FOSC		40	50	60	kHz
Maximum ON duty	MAXDuty			93		%
<b>Comparator</b>						
Input offset Voltage (Between CS and VREF)	V <sub>IO_VR</sub>			1	10	mV
Input current	I <sub>IOCS</sub>			160		nA
	I <sub>IOREF</sub>			80		nA
CS pin max voltage	VOM				1	V
malfunction prevention mask time	TMSK			150		ns
<b>Thermal protection Circuit</b>						
Thermal shutdown temperature	TSD	*Design guarantee		165		°C
Thermal shutdown hysteresis	ΔTSD	*Design guarantee		30		°C
<b>Drive Circuit</b>						
OUT sink current	I <sub>O</sub> I		500	1000		mA
OUT source current	I <sub>O</sub> O			120		mA
Minimum On time	TMIN			200	300	ns
<b>V<sub>IN</sub> current</b>						
UVLO mode V <sub>IN</sub> current	I <sub>CCOFF</sub>	V <sub>IN</sub> < UVLOON		80	120	μA
Normal mode V <sub>IN</sub> current	I <sub>CCON</sub>	V <sub>IN</sub> > UVLOON, OUT = OPEN		0.6		mA
<b>V<sub>IN</sub> Over Voltage Protection Circuit</b>						
V <sub>IN</sub> over voltage protection voltage	V <sub>IN</sub> OVP		24	27	30	V
V <sub>IN</sub> Current at OVP	I <sub>INOVP</sub>	V <sub>IN</sub> =30V	0.7	1.0	1.5	mA
<b>CS terminal abnormal sensing circuit</b>						
Abnormal sensing voltage	CSOCP			1.9		V

\*: Design guarantee (value guaranteed by design and not tested before shipment)

# LV5027M

## TYPICAL CHARACTERISTICS

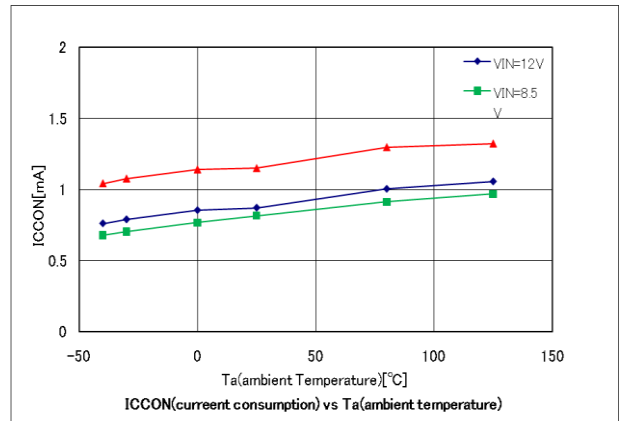
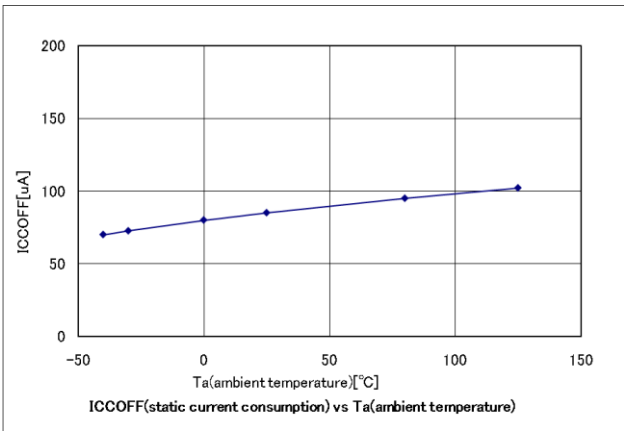
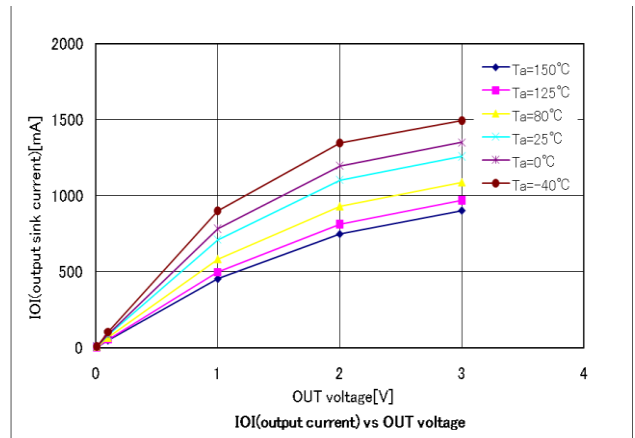
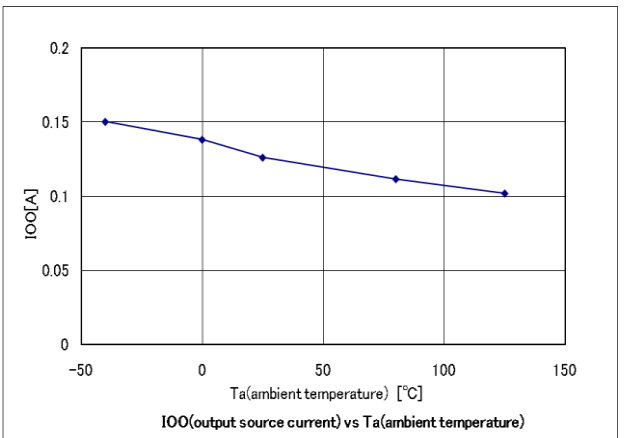
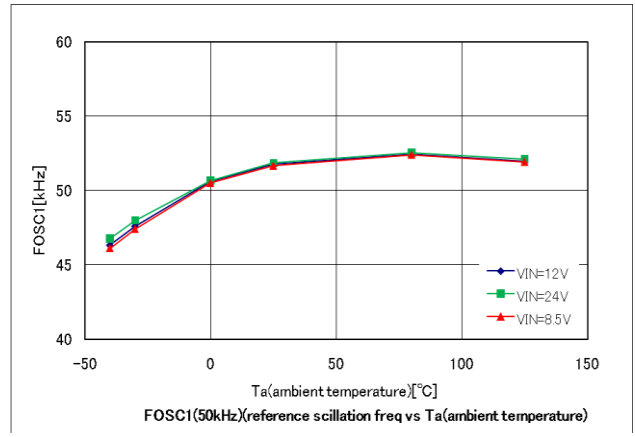
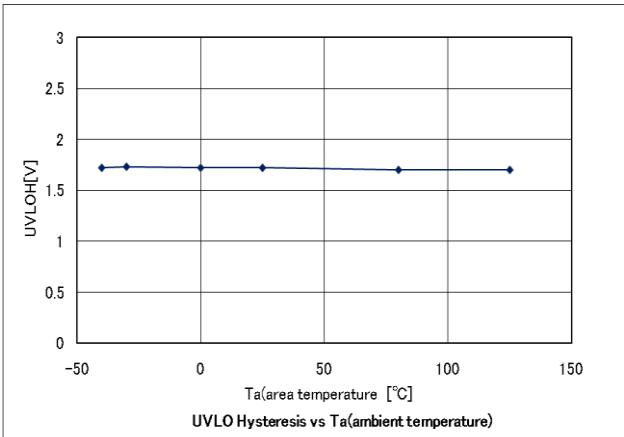
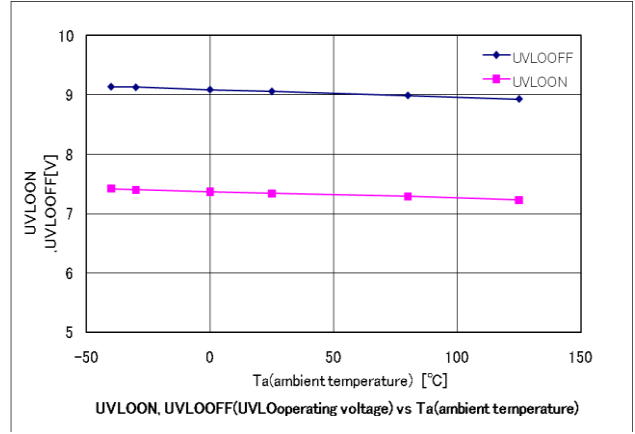
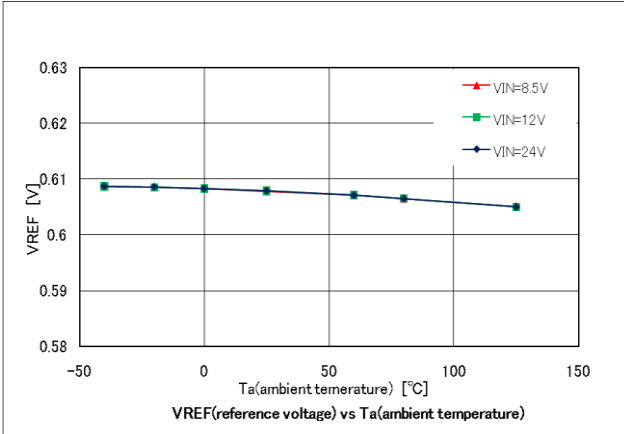

# LV5027M

## TYPICAL CHARACTERISTICS

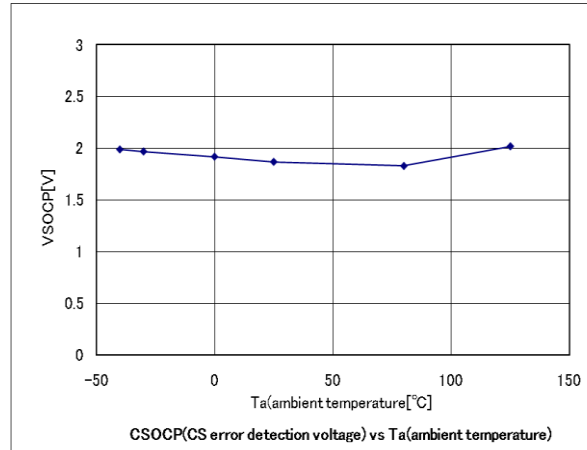
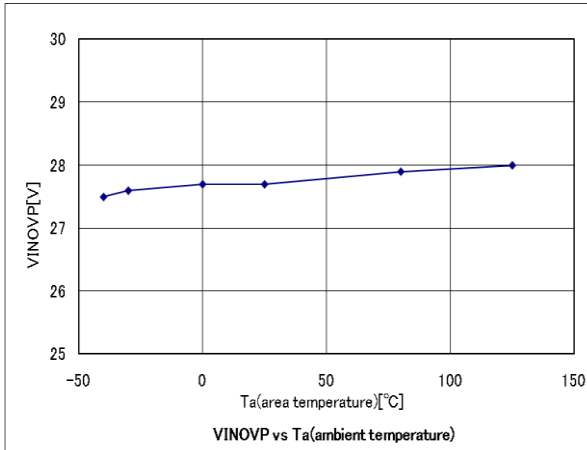

## TYPICAL CHARACTERISTICS

### Block Diagram

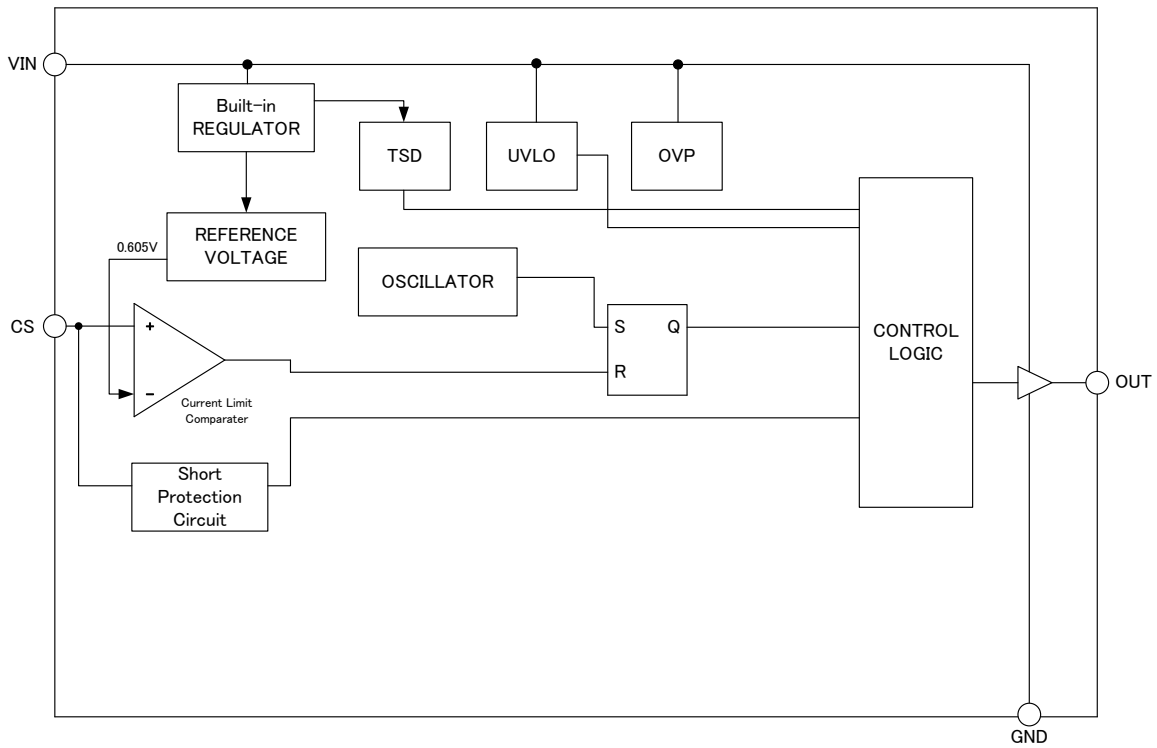

### Sample Application Circuit

#### Non isolation

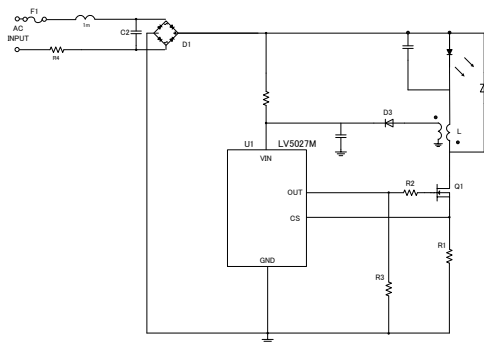

#### Isolation

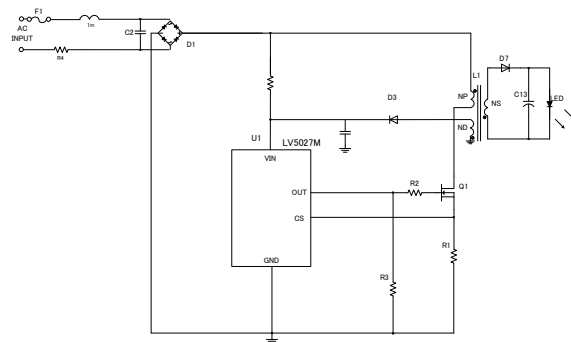

# LV5027M

## Package Dimensions

unit: mm (typ)

3086B

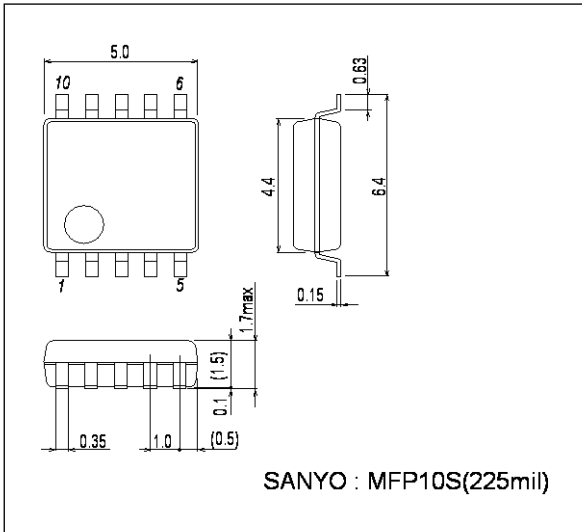

## Pin Assignment

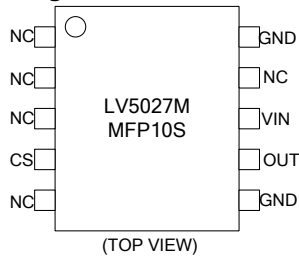

## Pin Functions

pin No	Pin Name	Pin Function	Equivalent Circuit
1	NC	No connection	
2	NC	No connection	
3	NC	No connection	
4	CS	LED current sensing in. If this terminal voltage exceeds VREF, external FET is OFF. And if the voltage of the terminal exceeds 1.9V, LV5027M turns to latch-off mode.	
5	NC	No connection	
6	GND	GND pin.	
7	OUT	Driving the external FET Gate Pin.	
8	VIN	Power supply pin. Operation : $V_{IN} > UVLOON$ Stop : $V_{IN} < UVLOFF$ Switching Stop : $V_{IN} > V_{INOVP}$	
9	NC	No connection	
10	GND	GND pin.	

## Relation ship between VREF and CS pin voltage

The output current value is the average of the current value that flows during one cycle. The current value that flows into coil is a triangular wave shown in the figure below. Make sure to set  $I_{pk}$  so that (average of current value at one cycle) is equal to (LED current value).  $I_{pk}$  is set by the relationship between VREF(internal reference voltage) voltage and Rcs voltage.

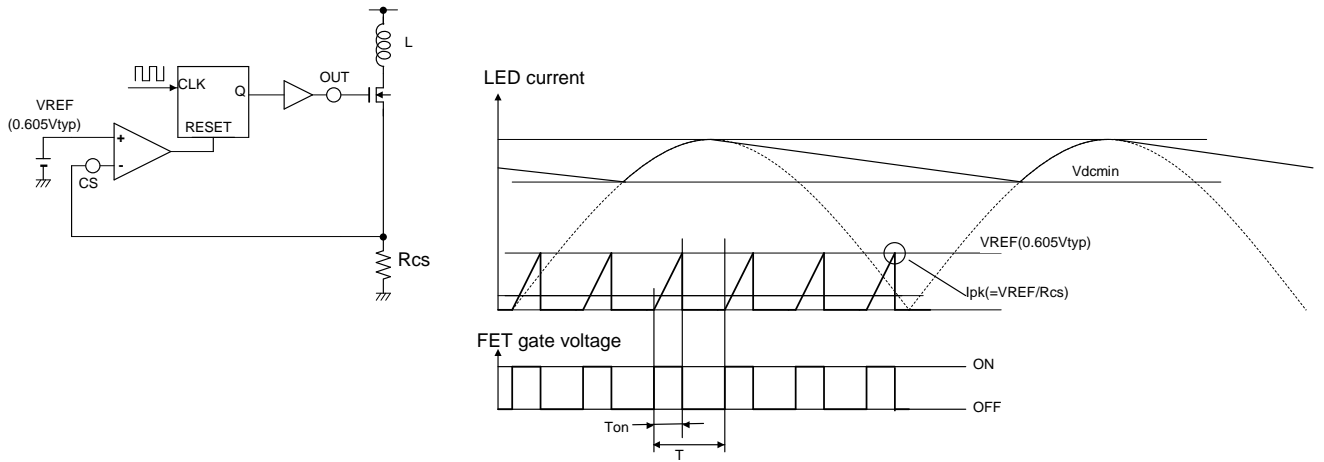

$$I_{pk} = \frac{VREF}{Rcs}$$

$I_{pk}$ : peak inductor current

$V_{IN}$ : AC power-supply voltage (minimum value)

VREF: Built-in reference voltage (0.605V)

Rcs: External sense resistor

**LED current and inductance setting**

It is available to use both no-isolation and isolation applications.

**(For non-isolation application)**

The output current value is the average of the inductor current value that flows during one cycle. The current value that flows into inductor is a triangular wave shown in the figure below. Make sure to set  $I_{pk}$  so that (average of inductor current value at one cycle) is equal to (LED current value).

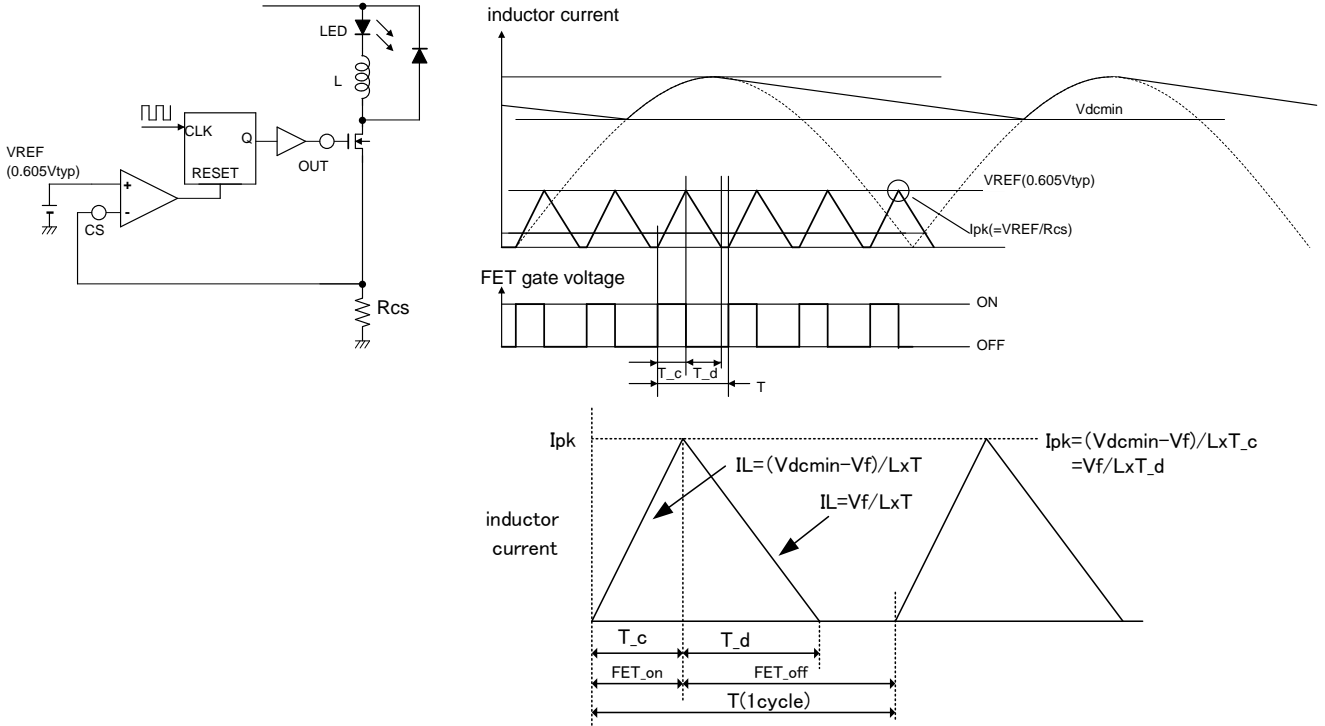

Given that the period when current flows into coil is

$$DutyI = \frac{T_c + T_d}{T}$$

$$I_{pk} \times \frac{1}{2} \times (DutyI \times T) / T = I_{LED}$$

$$I_{pk} = \frac{2 \times I_{LED}}{DutyI} \quad (1) \quad \text{since} \quad I_{pk} = \frac{V_{REF}}{R_{cs}}$$

$$R_{cs} = \frac{V_{FET}}{I_{pk}} = \frac{DutyI \times V_{REF}}{2 I_{LED}} \quad (2)$$

- $I_{pk}$ : peak inductor current
- $V_f$ : LED forward voltage drop
- $V_{dcmín}$ : AC power-supply voltage (Rectified minimum DC voltage)
- $V_{REF}$ : Built-in reference voltage (0.605V)
- $R_{cs}$ : External sense resistor

Since formula for LED current is different between on period and off period as shown above,

$$I_{pk} = \frac{V_{dcmín} - V_f}{L} \times T_c = \frac{V_f}{L} \times T_d \quad (3).$$

$$\text{Since } T_c + T_d = DutyI \times T, T_c = DutyI \times T - T_d \quad (4)$$

$$\text{Based on the result of (3) and (4), } T_d = DutyI \times T \times \frac{V_{dcmín} - V_f}{V_{dcmín}} \quad (5)$$

To obtain L from the equation (1), (3), (5),

$$L = \frac{V_f \times DutyI}{2 \times I_{LED}} \times DutyI \times T \times \frac{V_{dcmín} - V_f}{V_{dcmín}} = \frac{V_f}{2 \times I_{LED}} \times \frac{1}{f_{osc}} \times \frac{V_{dcmín} - V_f}{V_{dcmín}} \times (DutyI)^2 \quad (6)$$

Since LED and inductor are connected in serial in non-isolation mode, LED current flows only when AC voltage exceed  $V_f$ .

**(for Isolation application)**

Using the circuit diagram below, the wave form of the current that flows to Np and Ns is as follows.

Current waveform flows to primary side and secondary

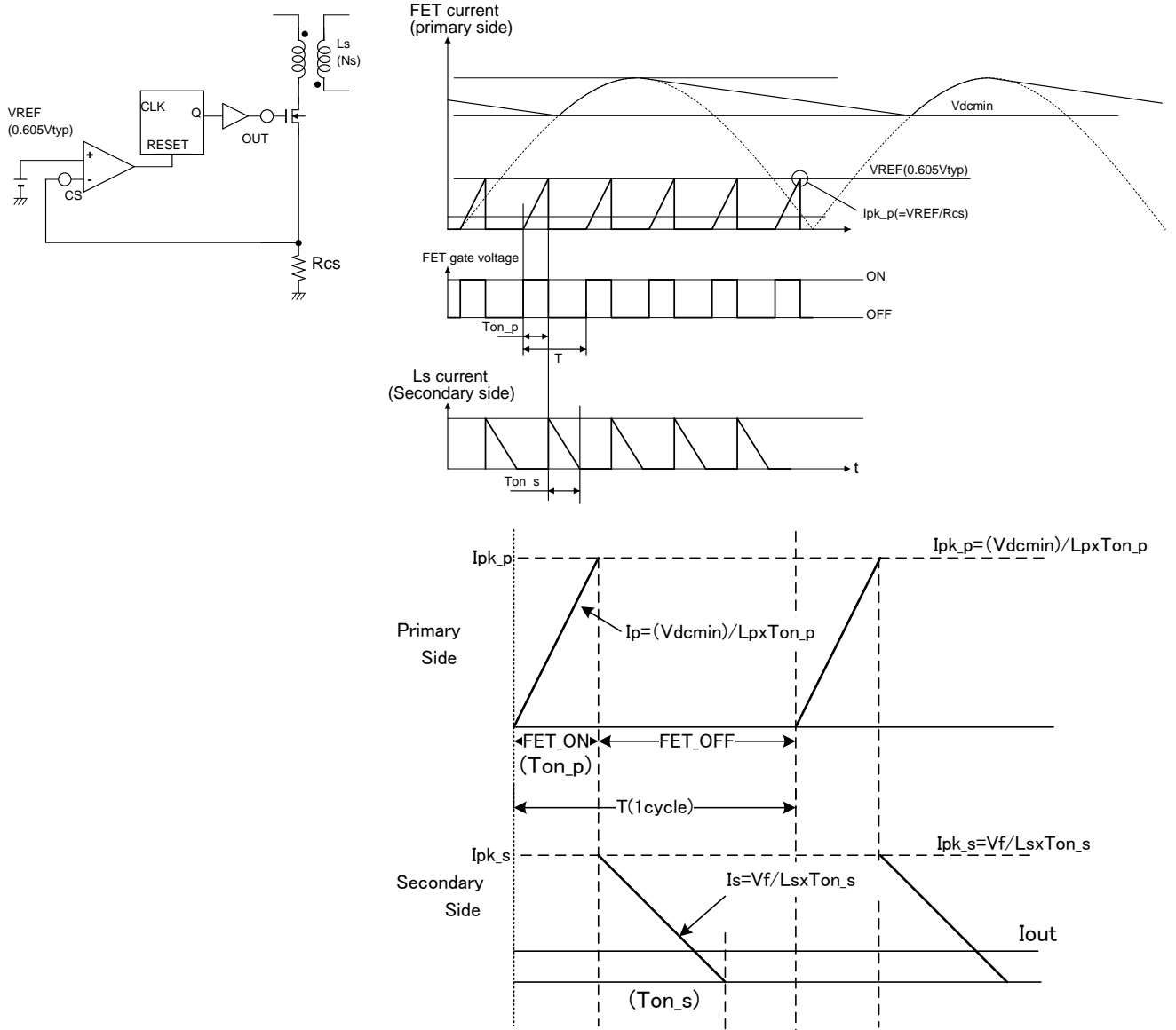

[Inductance Lp of primary side and sense resistor Rs]

If a peak current flow to transformer is represented as Ipk\_p, the power (Pin) charged to the transformer on primary side can be represented as:

$$Pin = \frac{1}{2} \times Lp \times (Ipk\_p)^2 \times fosc \quad (11)$$

$$\therefore Ipk\_p = \frac{Vdc\ min}{Lp} \times Ton\_p \quad (12)$$

$$\therefore Lp = \frac{Vdc\ min^2 \times Ton\_p^2 \times fosc}{2 \times Pin} = \frac{Vdc\ min^2 \times Don\_p^2}{2 \times Pin \times fosc} \quad (13)$$

$$(Don\_p = \frac{Ton\_p}{T} = Ton\_p \times fosc)$$

To substitute the following to the formula below,

$$\therefore \eta = \frac{Pout}{Pin} \quad (14)$$

$$\therefore Lp = \frac{Vdc\ min^2 \times Ton\_p^2 \times fosc \times \eta}{2 \times Pout} = \frac{Vdc\ min^2 \times Don^2 \times \eta}{2 \times Pout \times fosc} \quad (15)$$



Sense resistor is obtained as follows.

$$R_s = \frac{V_{REF}}{I_{pk\_p}} = \frac{V_{REF} \times L_p}{V_{dc \min} \times T_{on\_p}} = \frac{V_{REF} \times L_p}{V_{dc \min} \times Don\_p \times T} \quad (16)$$

[Inductance  $L_s$  of secondary side]

Since output current  $I_{out}$  is the average value of current flows to transformer of secondary side

$$I_{out} = I_{pk\_s} \times \frac{T_{on\_s}}{T} \times \frac{1}{2} = \frac{I_{pk\_s} \times Don\_s}{2} \quad (Don\_s = \frac{T_{on\_s}}{T} = T_{on\_s} \times f_{osc}) \quad (17)$$

$$I_{pk\_s} = \frac{V_{out}}{L_s} \times T_{on\_s} = \frac{V_{out}}{L_s} \times \frac{Don\_s}{f_{osc}} \quad (18)$$

$$L_s = \frac{V_{out} \times T \times Don\_s^2}{2 \times I_{out}} = \frac{V_{out} \times Don\_s^2}{2 \times I_{out} \times f_{osc}} = \frac{V_{out}^2 \times Don\_s^2}{2 \times P_{out} \times f_{osc}} \quad (19)$$

Calculation of the ratio of transformer coil on primary side and secondary side

Since ratio and inductance of transformer coil is

$$\frac{N_s}{N_p} = \frac{\sqrt{L_s}}{\sqrt{L_p}} \quad (20)$$

substituted equations (15), (19) for (20)

$$\therefore \frac{N_p}{N_s} = \frac{V_{dc \min}}{V_{out}} \times \sqrt{\eta} \times \frac{Don\_p}{Don\_s} \quad (21)$$

Calculation of transformer coil on primary side and secondary side

$$N = \frac{Vac \times 10^8}{2 \times \Delta B \times Ae \times f_{osc}} \quad (22)$$

$\Delta B$  : variation range of core flux density [Gauss]

$Ae$  : core section area [cm<sup>2</sup>]

To use Al (L value at 100T),

$$N = \sqrt{\frac{L}{Al}} \times 10^2 \quad (23)$$

$L$  : inductance [uH]

$Al$ : L value at 100T [uH/N<sup>2</sup>]

lg (Air gap) is obtained as follows:

$$lg = \frac{\mu_r \mu_0 N^2 Ae 10^2}{L} \quad (24)$$

$\mu_r$ : relative magnetic permeability,  $\mu_r = 1$

$\mu_0$ : vacuum magnetic permeability  $\mu_0 = 4\pi \times 10^{-7}$

$N$ : turn count [T]

$Ae$ : core section area [m<sup>2</sup>]

$L$ : inductance [H]

# LV5027M

## Description of operating protection function

	tilte	outline	monitor point	note
1	UVLO	Under Voltage Lock Out	VIN voltage	
2	OCP	Over Current Protection	CS voltage	equivalent FET current
3	OVP	Over Voltage Protection	VIN voltage	
4	OTP (TSD)	Over Temperature Protection (Thermal Shut Down))	PN Junction temperature	

### 1.UVLO(Under Voltage Lock Out)

If VIN voltage is 7.3V or lower, then UVLO operates and the IC stops. When UVLO operates, the power supply current of the IC is about 80uA or lower. If VIN voltage is 9V or higher, then the IC starts switching operation.

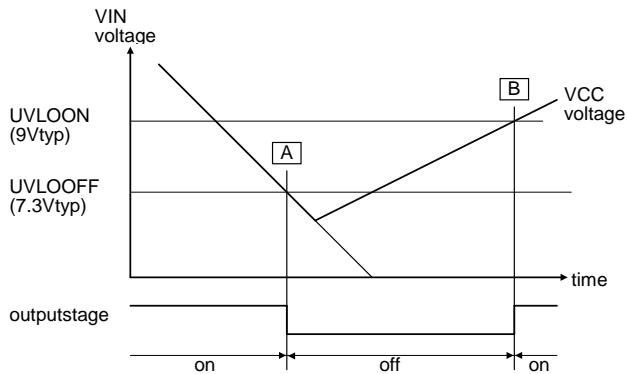

### 2.OCP(Over Current Protection)

The CS pin sense the current through the MOS FET switch and the primary side of the transformer.This provides an additional level of protection in the event of a fault. If the voltage of the CS pin exceeds VCSOCP(1.9Vtyp)(A), the internal comparator will detect the event and turn off the MOSFET. The peak switch current is calculated

$$I_o(\text{peak}) [A] = V\text{SOCP}[V]/R\text{sense}[\text{ohm}]$$

The VIN pin is pulled down to fixed level, keeping the controller latched off.The lach reset occurs when the user disconnects LED from VAC and lets the VIN falls below the VIN reset voltage,UVLOOFF(7.3Vtyp)(B). Then VIN rise UVLOON(9Vtyp)(C),restart the switching.

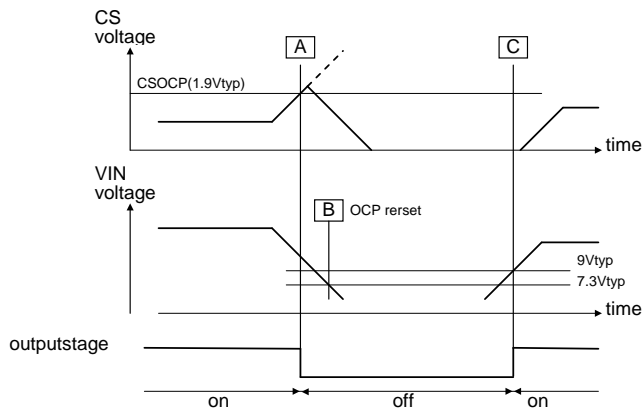

**3.OVP(Over Voltage Protection)**

If the voltage of VIN pin is higher than the internal reference voltage VINOVP(27Vtyp),switching operation is stopped. The stopping operation is kept until the voltage of VIN is lower than 7.3V. If the voltage of VIN pin is higher than 9V, the switching operation is restated.

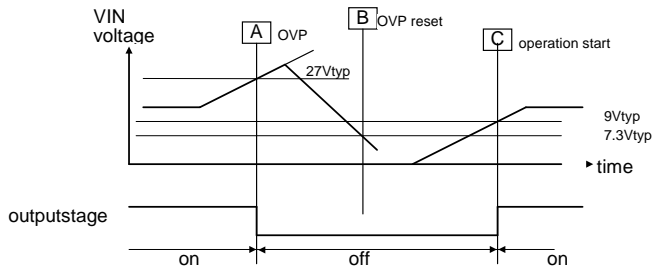

**4.TSD(thermal Shut Down protection)**

The thermal shutdown function works when the junction temperature of IC is 165°C (typ) (A), and the IC switching stops. The IC starts switching operation again when the junction temperature is 135°Ctyp (B) or lower.

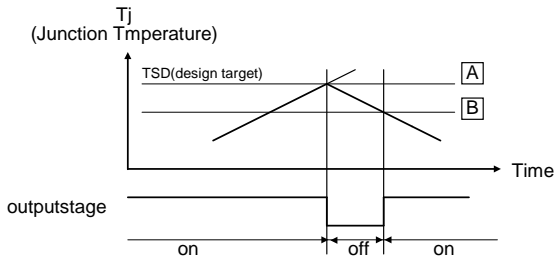

**Skip frequency function**

LV5027M contains the skip frequency function for reduction of the peak value of conduction noise. This function changes the frequency as follows.

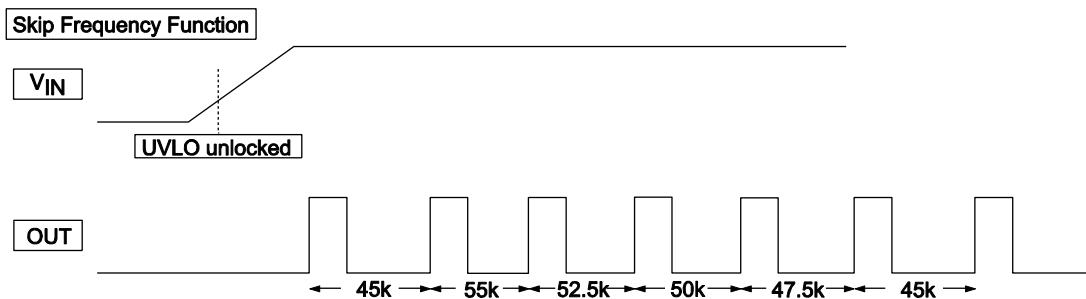

Switching frequency is changed as follows.  
 ... ×0.9 → ×1.1 → ×1.05 → ×1 → ×0.95 → ×0.9 → ×1.1 ...  
 It's repeated by this loop.

- SANYO Semiconductor Co.,Ltd. assumes no responsibility for equipment failures that result from using products at values that exceed, even momentarily, rated values (such as maximum ratings, operating condition ranges, or other parameters) listed in products specifications of any and all SANYO Semiconductor Co.,Ltd. products described or contained herein.
- SANYO Semiconductor Co.,Ltd. strives to supply high-quality high-reliability products, however, any and all semiconductor products fail or malfunction with some probability. It is possible that these probabilistic failures or malfunction could give rise to accidents or events that could endanger human lives, trouble that could give rise to smoke or fire, or accidents that could cause damage to other property. When designing equipment, adopt safety measures so that these kinds of accidents or events cannot occur. Such measures include but are not limited to protective circuits and error prevention circuits for safe design, redundant design, and structural design.
- In the event that any or all SANYO Semiconductor Co.,Ltd. products described or contained herein are controlled under any of applicable local export control laws and regulations, such products may require the export license from the authorities concerned in accordance with the above law.
- No part of this publication may be reproduced or transmitted in any form or by any means, electronic or mechanical, including photocopying and recording, or any information storage or retrieval system, or otherwise, without the prior written consent of SANYO Semiconductor Co.,Ltd.
- Any and all information described or contained herein are subject to change without notice due to product/technology improvement, etc. When designing equipment, refer to the "Delivery Specification" for the SANYO Semiconductor Co.,Ltd. product that you intend to use.
- Information (including circuit diagrams and circuit parameters) herein is for example only; it is not guaranteed for volume production.
- Upon using the technical information or products described herein, neither warranty nor license shall be granted with regard to intellectual property rights or any other rights of SANYO Semiconductor Co.,Ltd. or any third party. SANYO Semiconductor Co.,Ltd. shall not be liable for any claim or suits with regard to a third party's intellectual property rights which has resulted from the use of the technical information and products mentioned above.

This catalog provides information as of March, 2011. Specifications and information herein are subject to change without notice.