



### Description

The [XR33193](#), [XR33194](#), and [XR33195](#) are a high performance RS-485/RS-422 driver family offered in a tiny TSOT23 package designed to meet the increasing system requirements found in today's performance serial communication applications. These standalone drivers operate off a single 3.3V supply and meet RS-485 and RS-422 standards for balanced RS-485 and RS-422 serial communications networks.

The driver family offers several speed options to maximize performance in different applications. The XR33193 and XR33194 have slew limited outputs for reduced EMI and for error free communication over long or improper/unterminated data cables or multi-drop applications with unterminated stubs. The XR33195 driver operates at data rates up to 20Mbps with tight skew and prop delay spec's required by demanding high speed applications. All parts in the XR33193/94/95 driver family operate over the extended temperature range of  $-40^{\circ}\text{C}$  to  $125^{\circ}\text{C}$ .

The XR33193/94/95 driver family is protected by short-circuit detection as well as thermal shutdown and will maintain a high impedance state in shutdown or when powered off. The driver family also includes hot swap circuitry to protect against false transitions on the bus during power-up or live insertion.

For companion standalone RS-485/RS-422 receivers in tiny TSOT23 packages see our XR33180/81/83/84 product datasheet.

### FEATURES

- Data rate options of 250kbps, 2.5Mbps and 20Mbps
- Tiny 6-pin TSOT23 package
- 3.3V  $\pm 5\%$  supply operation
- Robust ESD protection
  - $\pm 15\text{kV}$  Human Body Model (bus pins)
  - $\pm 4\text{kV}$  Human Body Model (all other pins)
- Short-circuit protection
- Thermal protection circuitry
- Hot swap glitch protection
- Extended  $-40^{\circ}\text{C}$  to  $125^{\circ}\text{C}$  operating temperature range
- Low current shutdown mode (2uA max)
- Lead-free (RoHS compliant)

### APPLICATIONS

- Clock distribution
- Robotic control
- Space constrained systems
- Security camera networks
- Industrial and process control equipment

Ordering Information – [back page](#)

### Typical Application

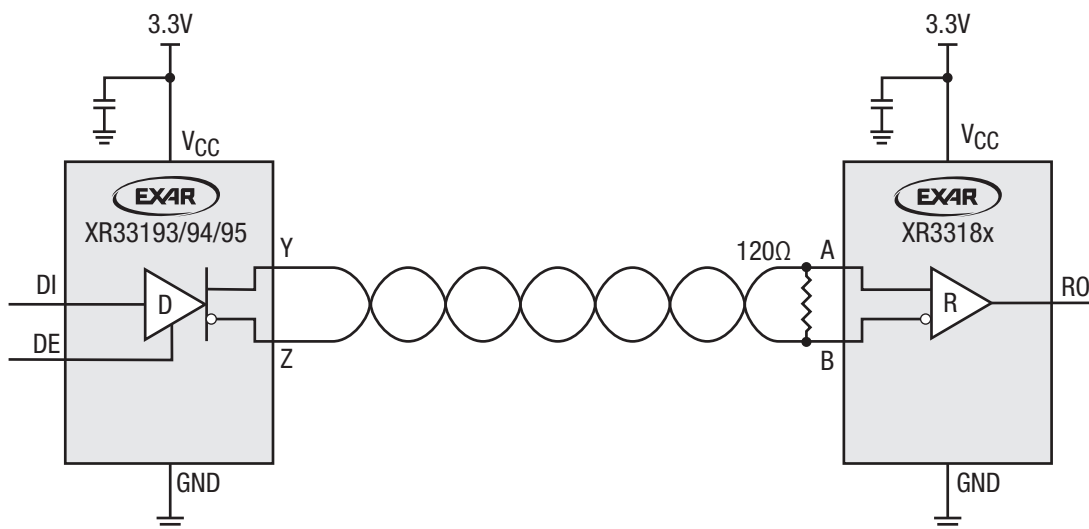

Figure 1. Typical Application

## Absolute Maximum Ratings

Stresses beyond the limits listed below may cause permanent damage to the device. Exposure to any Absolute Maximum Rating condition for extended periods may affect device reliability and lifetime.

Supply voltage ( $V_{CC}$ )	-0.3V to 7.0V
Maximum junction temperature	150°C
Input voltages, DI and DE	-0.3V to 7.0V
Bus output voltages Y and Z	$\pm 18V$
Transient voltage pulse through 100 $\Omega$ , Figure 7	$\pm 100V$

## Operating Conditions

Operating temperature range	-40°C to 125°C
$V_{CC}$ supply range	3.135V to 3.465V
Storage temperature range	-65°C to 150°C
Lead temperature (soldering, 10s)	300°C

## Thermal Information

6-pin TSOT23 $\theta_{JA}$	167.3°C/W
6-pin TSOT23 $\theta_{JC}$	61.6°C/W

## Electrical Characteristics

Specifications are at  $T_A = 25^\circ\text{C}$ ,  $V_{CC} = 3.3V \pm 5\%$  unless otherwise noted. Typical values represent the most likely parametric norm at  $T_A = 25^\circ\text{C}$ , and are provided for reference purposes only.

Symbol	Parameter	Conditions	Min	Typ	Max	Units
<b>Supply</b>						
$V_{CC}$	Supply voltage range		3.135		3.465	V
$I_{CC}$	Supply current	No load (DE = $V_{CC}$ , DI = 0V)		0.18	0.375	mA
$I_{SNDN}$	Supply current in shutdown mode	No load (DE = 0V)		0.5	2	$\mu\text{A}$
<b>Logic Inputs/Outputs</b>						
$V_{IH}$	Logic high input thresholds	DI and DE	2			V
$V_{IL}$	Logic high input thresholds	DI and DE			0.8	V
$I_{IN}$	Input current	DI and DE	-2		2	$\mu\text{A}$
<b>Driver DC Characteristics</b>						
$V_{OD}$	Differential driver voltage	No load	3			V
		$R_L = 100\Omega$ (RS-422), Figure 4	2			V
		$R_L = 54\Omega$ (RS-485), Figure 4	1.5			V
		$-7V \leq V_{CM} \leq 12V$ , Figure 5	1.5			V
$\Delta V_{OD}$	Change in magnitude of differential driver output voltage	$R_L = 54\Omega$ (RS-485) or 100 $\Omega$ (RS-422), DE = $V_{CC}$ , Figure 4			$\pm 0.2$	V
$V_{CM}$	Driver common-mode output voltage (steady state)	$R_L = 54\Omega$ (RS-485) or 100 $\Omega$ (RS-422), DE = $V_{CC}$ , DI = $V_{CC}$ or GND, Figure 4	-1	$V_{CC}/2$	3	V
$\Delta V_{CM}$	Change in magnitude of driver common-mode output voltage	$R_L = 54\Omega$ (RS-485) or 100 $\Omega$ (RS-422)			0.2	V
$V_{OL}$	Output leakage	Y and Z, $V_{OUT} = 12V$ , DE = 0V, $V_{CC} = 3.3V$ or GND	-20		20	$\mu\text{A}$
		Y and Z, $V_{OUT} = -7V$ , DE = 0V, $V_{CC} = 3.3V$ or GND	-20		20	$\mu\text{A}$
$I_{OSD}$	Driver short-circuit output current	$-7V \leq V_{OUT} \leq 12V$ , Figure 6			$\pm 250$	mA
<b>Thermal Characteristics</b>						
$T_{TS}$	Thermal shutdown temperature			165		$^\circ\text{C}$
$T_{TSH}$	Thermal shutdown hysteresis			40		$^\circ\text{C}$

## Electrical Characteristics (Continued)

Specifications are at  $T_A = 25^\circ\text{C}$ ,  $V_{CC} = 3.3\text{V} \pm 5\%$  unless otherwise noted. Typical values represent the most likely parametric norm at  $T_A = 25^\circ\text{C}$ , and are provided for reference purposes only.

Symbol	Parameter	Conditions	Min	Typ	Max	Units
ESD Protection						
	ESD protection for RS-485 bus pins, Y and Z	Human Body Model (HBM)		$\pm 15$		kV
	ESD protection for all other pins	Human Body Model (HBM)		$\pm 4$		kV
Driver AC Characteristics XR33193 (250kbps)						
$t_{DPLH}$	Driver propagation delay (low to high)	$C_L = 50\text{pF}$ , $R_L = 54\Omega$ , Figure 8	400		1300	ns
$t_{DPHL}$	Driver propagation delay (high to low)		400		1300	ns
$t_{SKEW}$	Driver propagation delay skew, $ t_{DPLH} - t_{DPHL} $				400	ns
$t_R$ , $t_F$	Differential output rise or fall time	$C_L = 50\text{pF}$ , $R_L = 54\Omega$ , Figure 8	400		1200	ns
	Device to device propagation delay matching <sup>(1)</sup>	Same power supply, maximum temperature difference between devices = $30^\circ\text{C}$			900	ns
	Maximum data rate	$C_L = 50\text{pF}$ , $R_L = 54\Omega$ , duty cycle 40 to 60%	250			kbps
$t_{DZH}$	Driver enable to output high	$C_L = 100\text{pF}$ , $R_L = 500\Omega$ , Figure 9			2000	ns
$t_{DZL}$	Driver enable to output low				2000	ns
$t_{DHZ}$	Driver disable from output high				1000	ns
$t_{DLZ}$	Driver disable from output low				1000	ns
Driver AC Characteristics XR33194 (2.5Mbps)						
$t_{DPLH}$	Driver propagation delay (low to high)	$C_L = 50\text{pF}$ , $R_L = 54\Omega$ , Figure 8	24		70	ns
$t_{DPHL}$	Driver propagation delay (high to low)		24		70	ns
$t_{SKEW}$	Driver propagation delay skew, $ t_{DPLH} - t_{DPHL} $				40	ns
$t_R$ , $t_F$	Differential output rise or fall time	$C_L = 50\text{pF}$ , $R_L = 54\Omega$ , Figure 8	10		70	ns
	Device to device propagation delay matching <sup>(1)</sup>	Same power supply, maximum temperature difference between devices = $30^\circ\text{C}$			46	ns
	Maximum data rate	$C_L = 50\text{pF}$ , $R_L = 54\Omega$ , duty cycle 40 to 60%	2.5			Mbps
$t_{DZH}$	Driver enable to output high	$C_L = 100\text{pF}$ , $R_L = 500\Omega$ , Figure 9			400	ns
$t_{DZL}$	Driver enable to output low				400	ns
$t_{DHZ}$	Driver disable from output high				100	ns
$t_{DLZ}$	Driver disable from output low				100	ns

### NOTE:

1. Guaranteed by design; not production tested.

## Electrical Characteristics (Continued)

Specifications are at  $T_A = 25^\circ\text{C}$ ,  $V_{CC} = 3.3\text{V} \pm 5\%$  unless otherwise noted. Typical values represent the most likely parametric norm at  $T_A = 25^\circ\text{C}$ , and are provided for reference purposes only.

Symbol	Parameter	Conditions	Min	Typ	Max	Units
Driver AC Characteristics XR33195 (20Mbps)						
$t_{DPLH}$	Driver propagation delay (low to high)	$C_L = 15\text{pF}$ , $R_L = 54\Omega$ , Figure 8			25	ns
$t_{DPHL}$	Driver propagation delay (high to low)				25	ns
$t_{SKEW}$	Driver propagation delay skew, $ t_{DPLH} - t_{DPHL} $			5		ns
$t_R$ , $t_F$	Differential output rise or fall time	$T_A = -40^\circ\text{C}$ to $125^\circ\text{C}$ , $C_L = 50\text{pF}$ , $R_L = 54\Omega$ , Figure 8			18.5	ns
		$T_A \leq 85^\circ\text{C}$ , $C_L = 50\text{pF}$ , $R_L = 54\Omega$ , Figure 8			15	ns
	Device to device propagation delay matching <sup>(1)</sup>	Same power supply, maximum temperature difference between devices = $30^\circ\text{C}$			25	ns
	Maximum data rate	$T_A \leq 85^\circ\text{C}$ , $C_L = 50\text{pF}$ , $R_L = 54\Omega$ , duty cycle 40 to 60%	20			Mbps
	Maximum data rate	$C_L = 50\text{pF}$ , $R_L = 54\Omega$ , duty cycle 40 to 60%	16			Mbps
$t_{DZH}$	Driver enable to output high	$C_L = 100\text{pF}$ , $R_L = 500\Omega$ , Figure 9			400	ns
$t_{DZL}$	Driver enable to output low				400	ns
$t_{DHZ}$	Driver disable from output high				100	ns
$t_{DLZ}$	Driver disable from output low				100	ns

### NOTE:

1. Guaranteed by design; not production tested.

## Pin Configuration

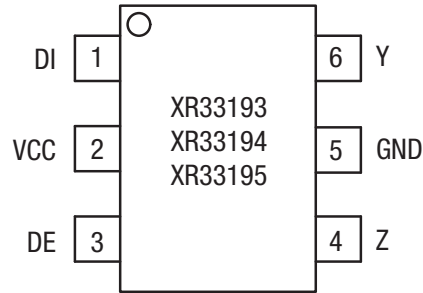

TSOT23-6, Top View

## Pin Functions

Pin Number			Pin Name	Type	Description
XR33193	XR33194	XR33195			
1	1	1	DI	Input	Driver input. A low on DI forces the Y output low and the Z output high. A high on DI forces the Y output high and the Z output low.
2	2	2	VCC	Supply	Power supply ( $V_{CC} = 3.3V \pm 5\%$ ). Bypass with $0.1\mu F$ capacitor to ground.
3	3	3	DE	Input	Driver output enable. A high on DE enables the driver outputs (Y and Z). A low on DE will disable the driver outputs (Y and Z), tri-stating the outputs and putting the device into shutdown (low power) state. The hot swap function is implemented on the DE pin, see Applications Information section for a description of hot swap function.
4	4	4	Z	Bus Output	$\pm 15kV$ ESD protected, RS-485/RS-422 inverting driver output.
5	5	5	GND	Supply	Ground.
6	6	6	Y	Supply	$\pm 15kV$ ESD protected, RS-485/RS-422 non-inverting driver output.

## Functional Block Diagram

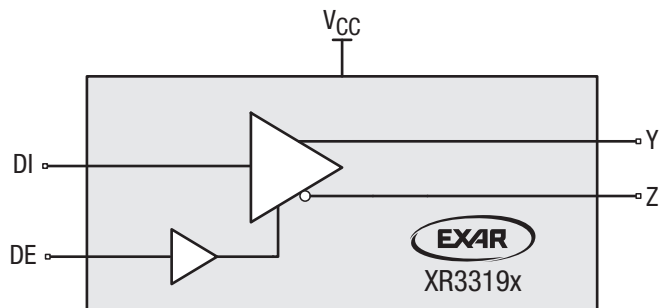

Figure 2. Functional Block Diagram

## Applications Information

The XR3319x RS-485/RS-422 devices are part of Exar's high performance serial interface product line. These standalone drivers operate off a single 3.3V supply and meet RS-485 and RS-422 standards for balanced RS-485 and RS-422 serial communications networks.

### Hot Swap Capability

When  $V_{CC}$  is first applied the XR3319x family holds the driver enable inactive for approximately 10 $\mu$ s. During power ramp-up, other system ICs may drive unpredictable values or tristated lines may be influenced by stray capacitance. The hot swap feature prevents the XR3319x family from driving any output signal until power has stabilized. After the initial 10 $\mu$ s, the driver enable pin is weakly pulled to the disabled state (low for DE) until the first transition. After the first transition, the DE pin operate as high impedance input.

If circuit boards are inserted into an energized backplane (commonly called "live insertion" or "hot swap") power may suddenly be applied to all circuits. Without the hot swap capability, this situation could improperly enable the transceiver's driver, driving invalid data onto shared buses and possibly causing driver contention or device damage.

### Driver Output Protection

Two mechanisms prevent excessive output current and power dissipation caused by faults or by bus contention. First, a driver current limit on the output stage provides immediate protection against short circuits over the whole common-mode voltage range. Second, a thermal shutdown circuit forces the driver outputs into a high impedance state if junction temperature becomes excessive.

### Line Length

The RS-485/RS-422 standard covers line lengths up to 4000ft. Maximum achievable line length is a function of signal attenuation and noise. Termination prevents signal reflections by eliminating the impedance mismatches on a transmission line. Line termination is generally used if rise and fall times are shorter than the round trip signal propagation time. Higher output drivers may allow longer cables to be used.

### $\pm 15$ kV HBM ESD Protection (Unpowered Part)

ESD protection structures are incorporated on all pins to protect against electrostatic discharges encountered during handling and assembly. The driver outputs of the XR3319x family have extra protection against static electricity. Exar uses state-of-the-art structures to protect these pins against ESD damage:

- $\pm 15$ kV HBM for bus pins to GND
- $\pm 4$ kV HBM for all other pins

### ESD Test Conditions

ESD performance depends on a variety of conditions. Contact Exar for a reliability report that documents test setup, methodology and results.

### Low Power Shutdown Mode

The XR3319x has a low-power shutdown mode that is initiated by bringing DE low (to disable the XR33193/94/95). While in shutdown the XR3319x draws less than 2 $\mu$ A of supply current.

Applications Information (Continued)

Product Selector Guide

Part Number	Data Rate (Mbps)	Slew-Rate Limited	Package
XR33193	0.25	Yes	6-pin TSOT23
XR33194	2.5	Yes	
XR33195	20	No	

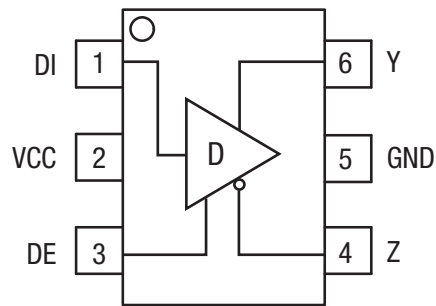

Figure 3. Differential Driver

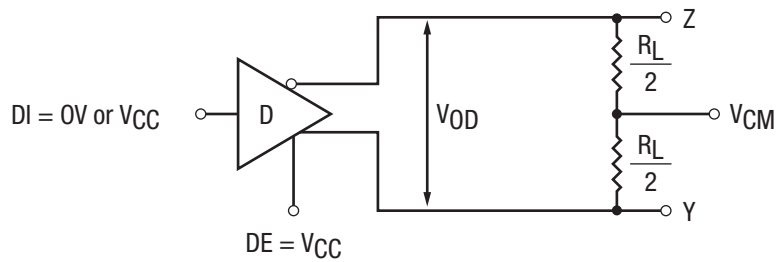

Figure 4. Differential Driver Output Voltage

Applications Information (Continued)

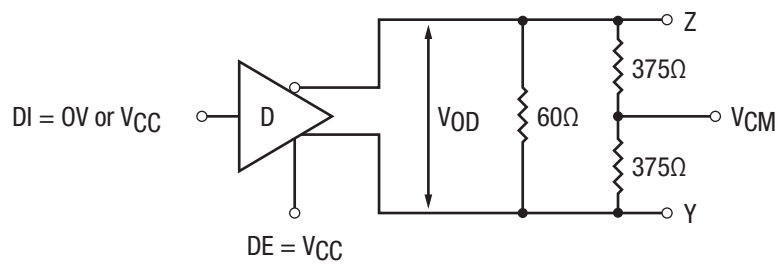

Figure 5. Differential Driver Output Voltage Over Common Mode

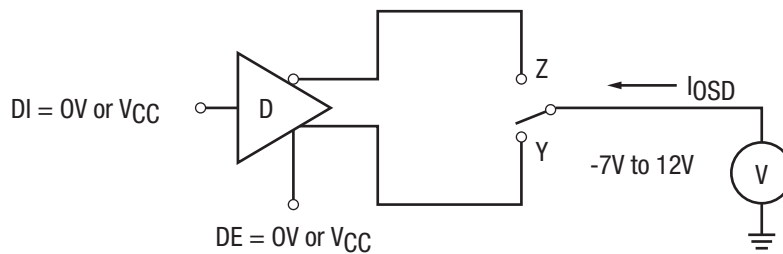

Figure 6. Driver Output Short-Circuit Current

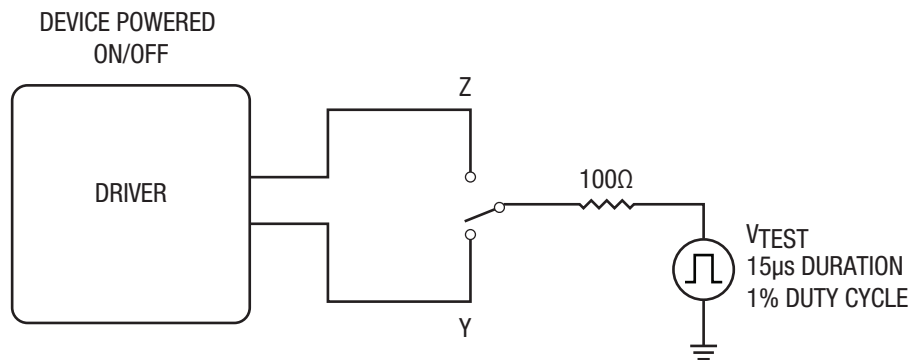

Figure 7. Transient Overvoltage Test Circuit



## Applications Information (Continued)

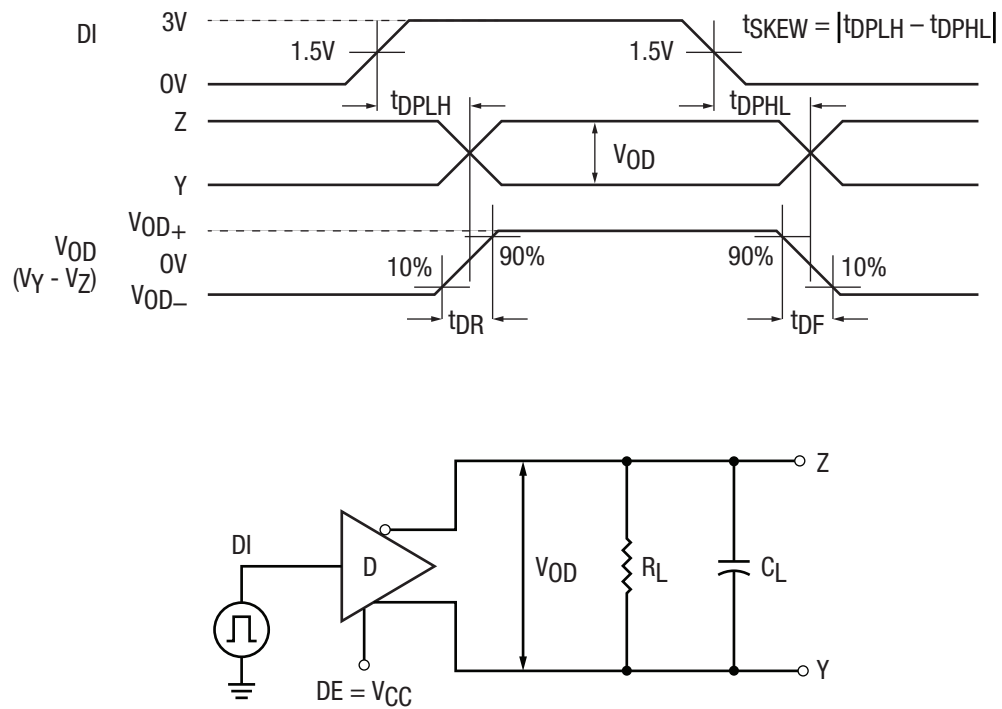

Figure 8. Driver Propagation Delay Test Circuit and Timing Diagram

Applications Information (Continued)

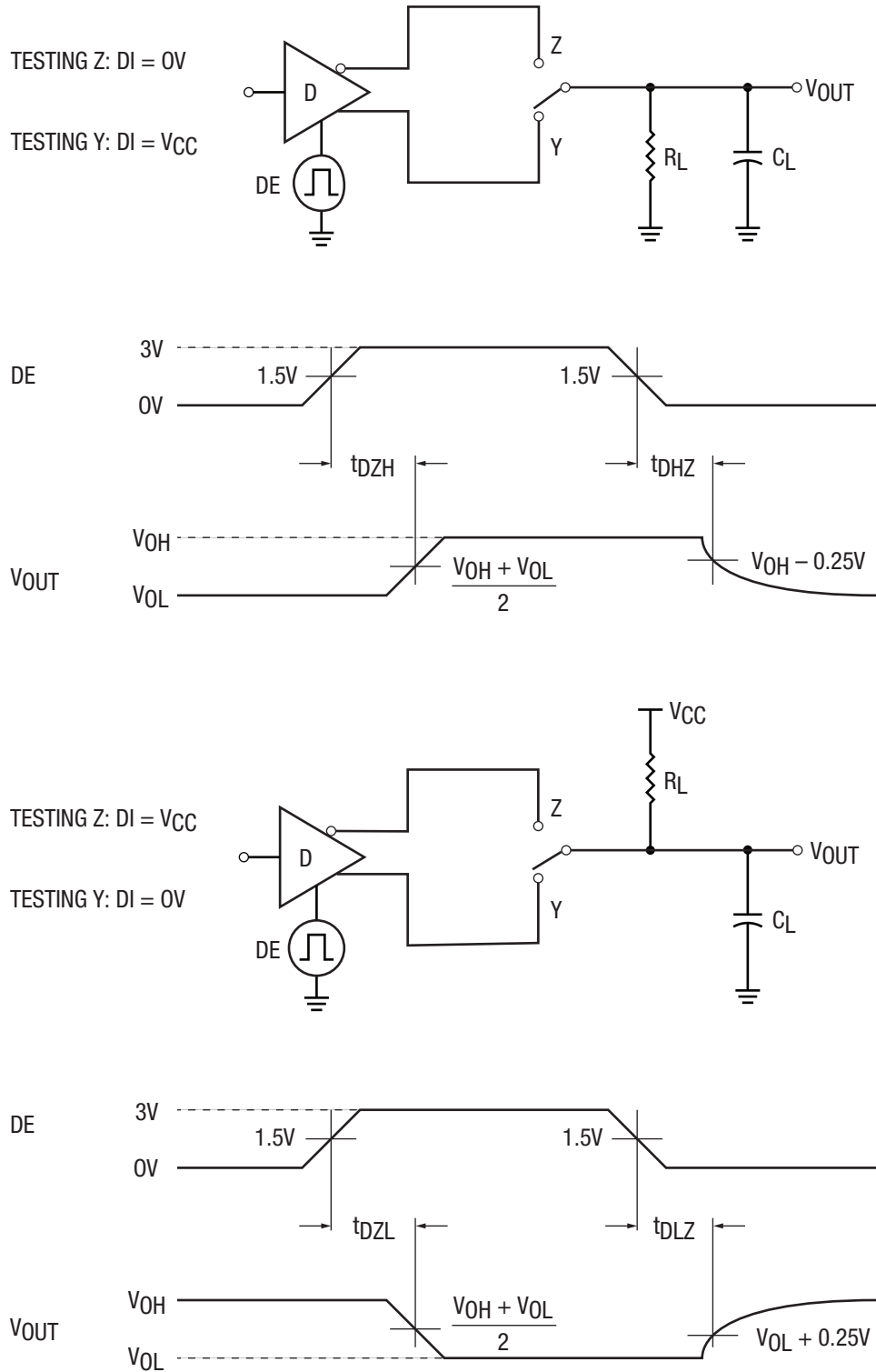
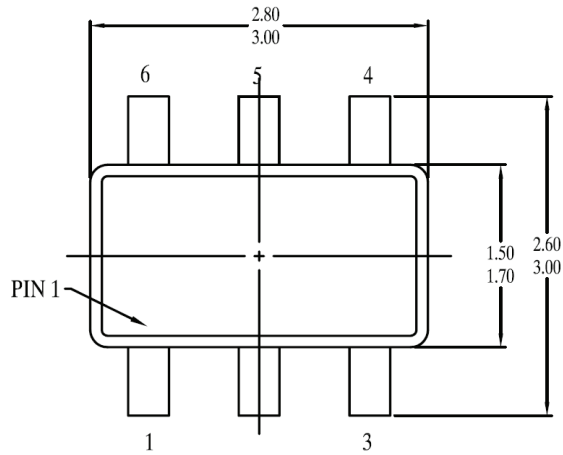
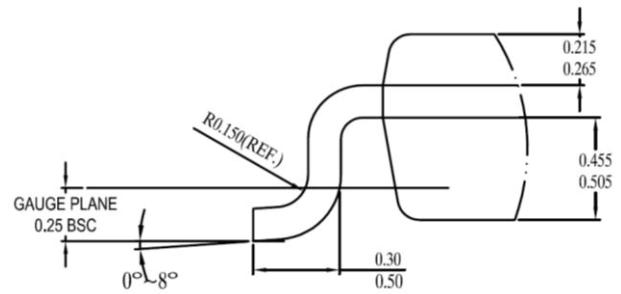

Figure 9. Driver Enable and Disable Timing Test Circuits and Timing Diagrams

Package Description



TOP VIEW



DETAIL "A"

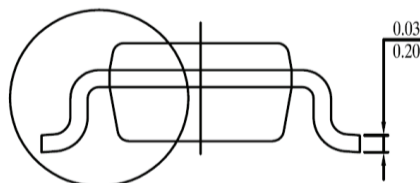

SEE DETAIL "A"

SIDE VIEW-1

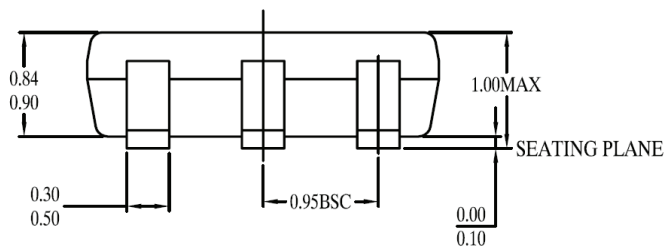

SIDE VIEW - 2

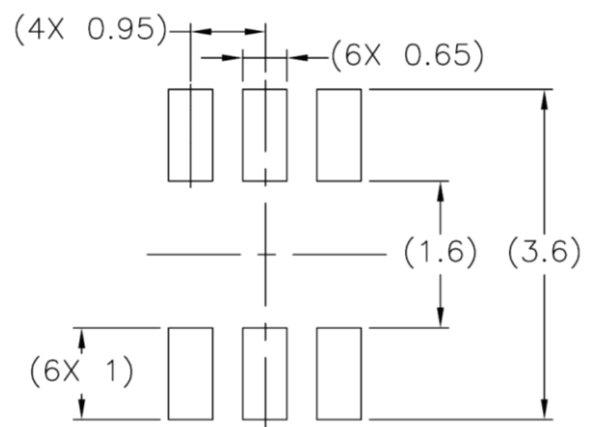

TYPICAL RECOMMENDED LAND PATTERN

1. All dimensions are in Millimeters
2. Dimensions and tolerance per Jecdec MO-193

## Ordering Information

Part Number	Speed (Mbps)	Slew Rate Limited	Operating Temperature Range	Environmental Rating	Package	Packaging Quantity
XR33193ESBTR	0.250	Yes	-40°C to 125°C	RoHS compliant and Green <sup>(1)</sup>	6-pin TSOT23	3k Tape and Reel
XR33194ESBTR	2.50	Yes				
XR33195ESBTR	20	No				
XR33193ESBEVB	Evaluation board					
XR33194ESBEVB						
XR33195ESBEVB						

**NOTE:**

1. Visit [www.exar.com](http://www.exar.com) for more information.

## Revision History

Revision	Date	Description
1A	July 2016	Initial release.



[www.exar.com](http://www.exar.com)

48760 Kato Road  
Fremont, CA 94538  
USA

Tel.: +1 (510) 668-7000  
Fax: +1 (510) 668-7001  
Email: [serialtechsupport@exar.com](mailto:serialtechsupport@exar.com)

Exar Corporation reserves the right to make changes to the products contained in this publication in order to improve design, performance or reliability. Exar Corporation conveys no license under any patent or other right and makes no representation that the circuits are free of patent infringement. While the information in this publication has been carefully checked, no responsibility, however, is assumed for inaccuracies.

Exar Corporation does not recommend the use of any of its products in life support applications where the failure or malfunction of the product can reasonably be expected to cause failure of the life support system or to significantly affect its safety or effectiveness. Products are not authorized for use in such applications unless Exar Corporation receives, in writing, assurances to its satisfaction that: (a) the risk of injury or damage has been minimized; (b) the user assumes all such risks; (c) potential liability of Exar Corporation is adequately protected under the circumstances.

Reproduction, in part or whole, without the prior written consent of Exar Corporation is prohibited. Exar, XR and the XR logo are registered trademarks of Exar Corporation. All other trademarks are the property of their respective owners.

©2016 Exar Corporation