

N 50 Ω

Attenuator
Plug / Jack 20 Watt

53AS120-K20N3

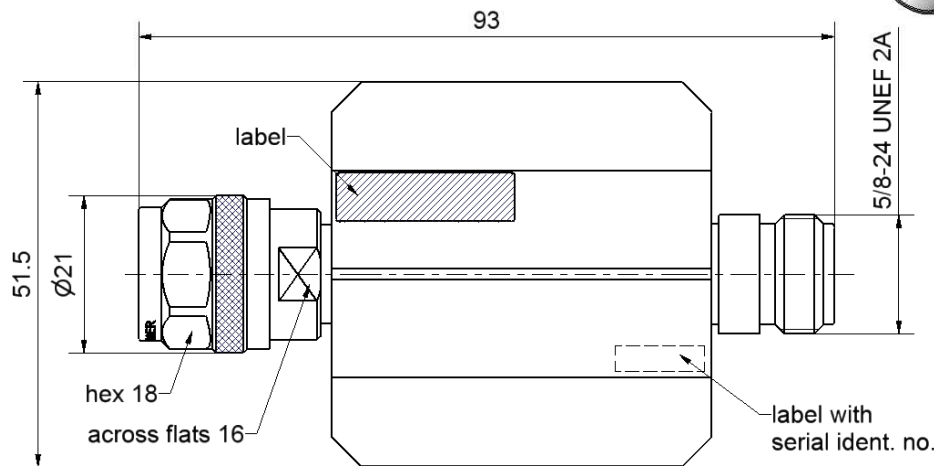

All dimensions are in mm; tolerances according to ISO 2768 m-H

Interface

According to IEC 61169-16

Documents

N/A

Material and plating

Connector parts

- Center conductor - plug
- Center conductor - jack
- Outer conductor
- Coupling nut
- Heatsink
- Dielectric
- Substrate

Material

- Brass
- Beryllium copper
- Brass
- Brass
- Aluminum
- PTFE
- AlN

Plating

- Gold, min. 1.27 μm, over nickel
- Gold, min. 1.27 μm, over nickel
- Flash white bronze over silver(e.g. Optargen®)
- White bronze(e.g. Optalloy®)
- Black anodized

Technical Data Sheet

Rosenberger

N 50 Ω

Attenuator
Plug / Jack 20 Watt

53AS120-K20N3

Electrical data

Impedance	50 Ω
Frequency	DC to 10 GHz
Return loss	≥ 26.4 dB, DC to 2 GHz ≥ 21.2 dB, 2 GHz to 5 GHz ≥ 14.0 dB, 5 GHz to 10 GHz
Attenuation	20 dB \pm 0.4 dB, DC to 2 GHz 20 dB \pm 0.5 dB, 2 GHz to 4 GHz 20 dB \pm 1.5 dB, 4 GHz to 10 GHz
Power handling (at 25 °C, sea level)	≤ 20 W, derated linearity by 0.2 W/K

Mechanical data

Mating cycles	≥ 500
Coupling nut retention	≥ 450 N
Center contact captivation	≥ 28 N
Coupling test torque	≤ 1.7 Nm
Recommended torque	0.7 Nm to 1.1 Nm

Environmental data

Temperature range	-65 °C to +125 °C
RoHS	compliant

Tooling

N/A

Suitable cables

N/A

Packing

Standard	1 pce in air cushion bag
Weight	270 g/pce

While the information has been carefully compiled to the best of our knowledge, nothing is intended as representation or warranty on our part and no statement herein shall be construed as recommendation to infringe existing patents. In the effort to improve our products, we reserve the right to make changes judged to be necessary.

Draft	Date	Approved	Date	Rev.	Engineering change number	Name	Date
Kerstin Herzog	05.08.05	Markus Müller	20.07.18	c00	18-1027	Marion Striegler	20.07.18
Rosenberger Hochfrequenztechnik GmbH & Co. KG P.O.Box 1260 D-84526 Tittmoning Germany www.rosenberger.de						Tel. : +49 8684 18-0 Email : info@rosenberger.de	Page 2 / 2