

Microelectronic Power IC

HEXFET® Power MOSFET Photovoltaic Relay
Single Pole, Normally Open,
0-280VAC (RMS) or 0-400VDC, 1.0A AC/DC

General Description

The PVX6012 Photovoltaic Relay is a single-pole, normally open solid-state relay that can replace electromechanical relays in many applications. It utilizes an IGBT output switch, driven by an integrated circuit photovoltaic generator of novel construction. The output switch is controlled by radiation from a GaAlAs light emitting diode (LED) which is optically isolated from the photovoltaic generator.

The PVX6012 is ideally suited for switching medium power loads. It offers high operating speed, low and stable on-state voltage drop as well as low off-state leakage current.

PVX6012 relays are packaged in a 14-pin, molded DIP package in thru-hole. It is available in standard plastic shipping tubes.

Applications

- Test Equipment
- Industrial Controls and Automation
- Electromechanical Relay Replacement
- Mercury-wetted Relay Replacement

Features

- IGBT and HEXFRED™ output
- Bounce-free operation
- 3,750 V_{RMS} I/O isolation
- High load current capacity
- Low off-state leakage current
- Solid-State reliability
- UL recognized

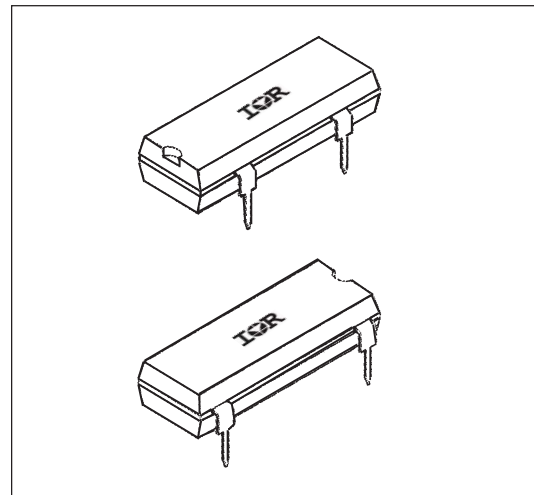

Part Identification

PVX6012PbF thru-hole

(HEXFET is the registered trademark for International Rectifier's power MOSFETs)

Electrical Specifications (-40°C ≤ T_A ≤ +85°C unless otherwise specified)

INPUT CHARACTERISTICS	Limits	Units
Minimum Control Current (see figure 1)	5.0	mA
Maximum Control Current for Off-State Leakage @T _A =+25°C	0.4	mA
Control Current Range (Caution: current limit input LED, see figure 6)	5.0 to 25	mA
Maximum Reverse Voltage	6.0	V

OUTPUT CHARACTERISTICS	Limits	Units
Transient Overvoltage Protection	600	V(DC or AC peak)
Operating Voltage	0-280 0-400	V(AC) RMS V(DC)
Maximum Load Current @ T _A = +40°C	1.0	A(DC)
5mA Control (see figure 1 and Note 1)	1.0	A (AC) RMS
Maximum Surge Current		
non-repetitive, 1 sec.	5	A(DC)
non-repetitive 20 msec. (see figure 2)	20	A(DC)
Maximum On-State Voltage Drop @T _A =+25°C	2.5	V
For 1A pulsed load, 5mA Control (see figures 3 and 4)		
Maximum Off-State Leakage @T _A =+25°C, ± 400V (see figure 5)	10	µA
Maximum Turn-On Time @T _A =+25°C (see figure 8)	7	ms
For 1A, 400 V _{DC} load, 5mA Control		
Maximum Turn-Off Time @T _A =+25°C (see figure 8)	1	ms
For 1A, 400 V _{DC} load, 5mA Control		
Maximum Output Capacitance @ 100V _{DC} (see figure 7)	50	pF

Notes: Load handling capability to 0.2 power factor requires overvoltage protection.

GENERAL CHARACTERISTICS	Limits	Units
Minimum Dielectric Strength, Input-Output	3750	V _{RMS}
Minimum Insulation Resistance, Input-Output	10 ¹²	Ω
@T _A =+25°C, 50%RH, 100V _{DC}		
Maximum Capacitance, Input-Output	1.0	pF
Maximum Pin Soldering Temperature (10 seconds maximum)	+260	
Ambient Temperature Range:		°C
Operating	-40 to +85	
Storage	-40 to +100	

International Rectifier does not recommend the use of this product in aerospace, avionics, military or life support applications. Users of this International Rectifier product in such applications assume all risks of such use and indemnify International Rectifier against all damages resulting from such use.

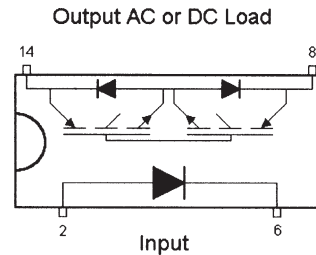
Connection Diagram

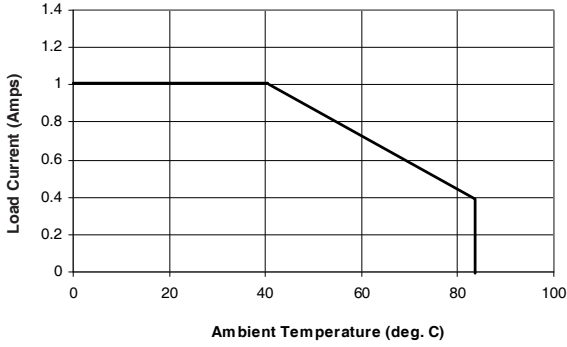

Figure 1. Current Derating Curve

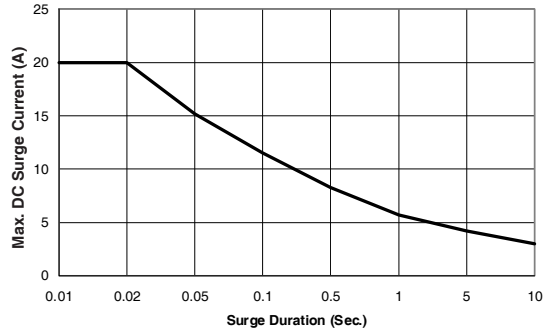

Figure 2. Surge Current Capability

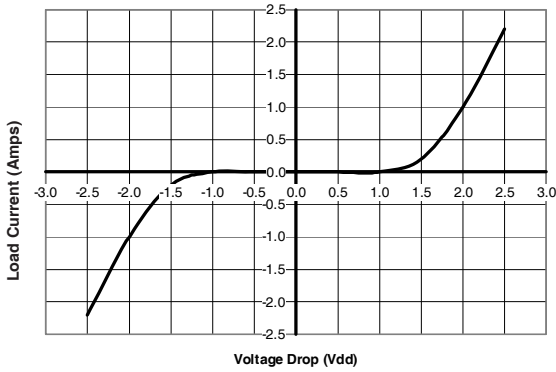

Figure 3. Output Characteristics

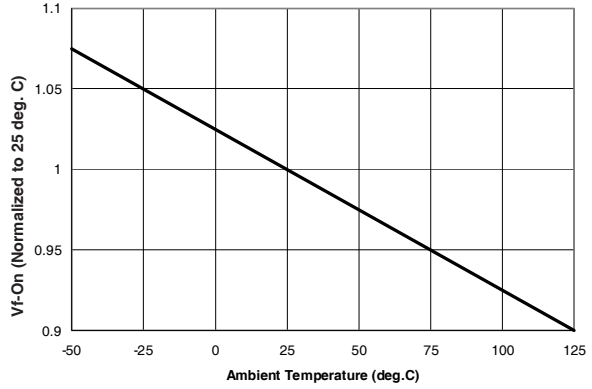

Figure 4. Typical Normalized VCEON

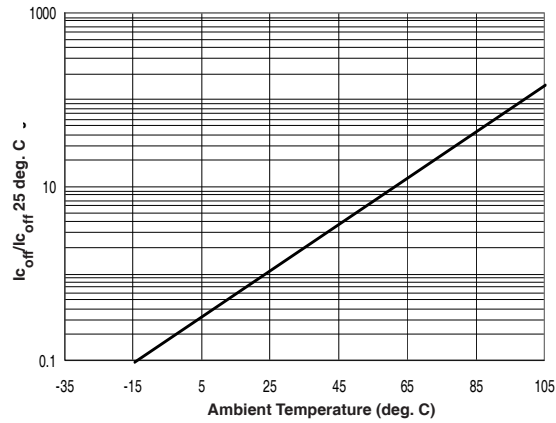

Figure 5. Typical Normalized Off-State Leakage

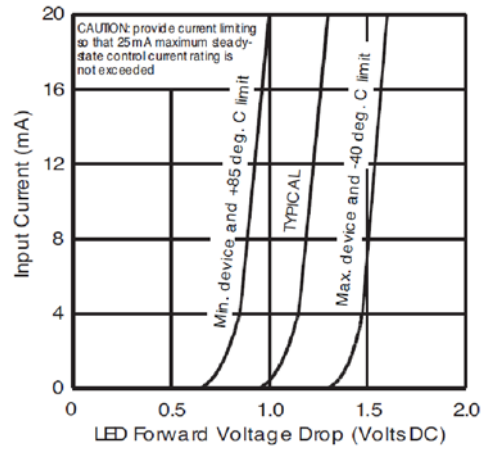

Figure 6. Input Characteristics (Current Controlled)

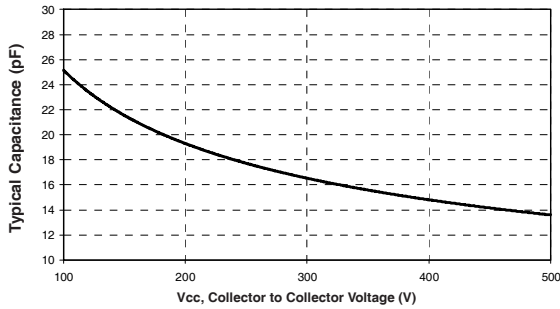

Figure 7. Typical Output Capacitance

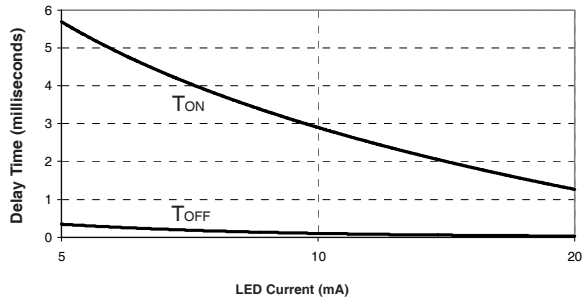

Figure 8. Typical Delay Times

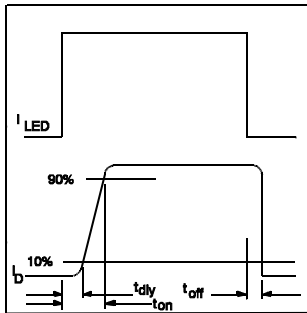
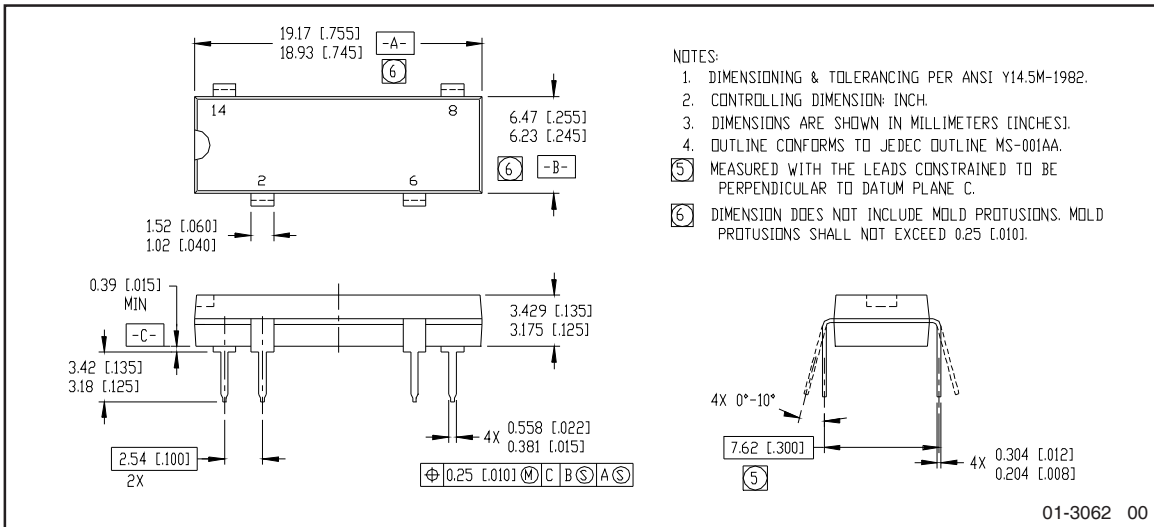

Figure 9. Delay Time Definitions

Case Outline



Note: For the most current drawing please refer to IR website at: <http://www.irf.com/package/>

Qualification information[†]

Qualification level	Industrial (per JEDEC JESD47I ^{††} guidelines)	
Moisture Sensitivity Level	PVX6012PbF	N/A
RoHS compliant	Yes	

† Qualification standards can be found at International Rectifier's web site: <http://www.irf.com/product-info/reliability>
 †† Applicable version of JEDEC standard at the time of product release

Revision History

Date	Comment
6/9/2015	<ul style="list-style-type: none"> • Added Qualification Information table on page 5. • Updated data sheet based on corporate template.