

MSI1225 series

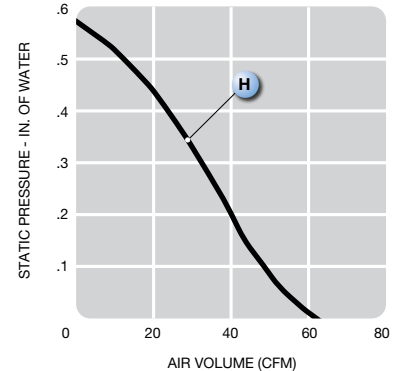
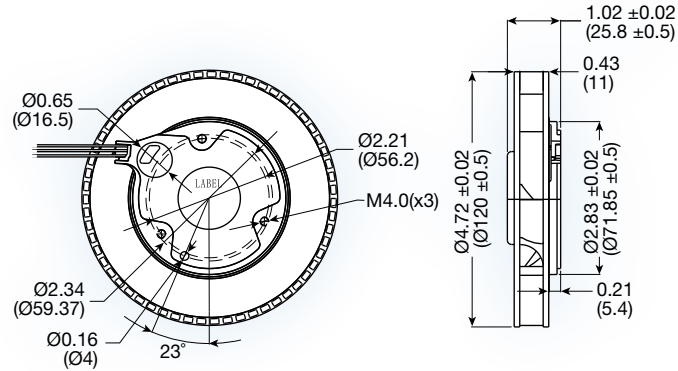

(120 dia. x 25 mm)

4.72 dia. x 0.98 inches

Features:	soft start, polarity protection, auto-restart
Operating Voltage:	12 or 24 VDC
Construction:	aluminum die cast motor base; UL94V-0 plastic impeller
Bearing option:	ball bearing
Motor:	brushless DC

Model No.	Rated Voltage VDC	Current A		Speed RPM	Air Volume		Max. Static Pressure (H ₂ O)		Sound Noise dba	Weight g
		12	24		M ³ /Min.	CFM	MM	INCH		
MSI1225H	12/24	1.00	0.48	3,500	1.79	63.2	14.55	0.57	54	161

