



STPS30170C

HIGH VOLTAGE POWER SCHOTTKY RECTIFIER

Table 1: Main Product Characteristics

$I_{F(AV)}$	2 x 15 A
V_{RRM}	170 V
T_j	175 °C
$V_F(max)$	0.75 V

FEATURES AND BENEFITS

- High junction temperature capability
- Low leakage current
- Good trade off between leakage current and forward voltage drop
- Insulated package: TO-220FPAB
Insulating voltage: 2000 V DC
Capacitance: 45 pF
- Avalanche specification

DESCRIPTION

Dual center tab Schottky rectifier suited for High Frequency Switch Mode Power Supply.

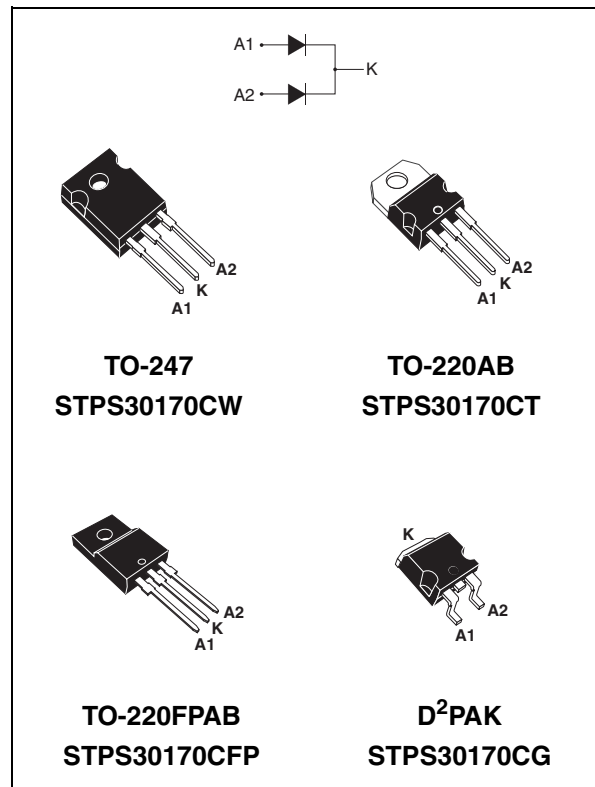

Table 2: Order Codes

Part Numbers	Marking
STPS30170CW	STPS30170CW
STPS30170CT	STPS30170CT
STPS30170CFP	STPS30170CFP
STPS30170CG	STPS30170CG
STPS30170CG-TR	STPS30170CG

STPS30170C

Table 3: Absolute Ratings (limiting values, per diode)

Symbol	Parameter			Value	Unit	
V_{RRM}	Repetitive peak reverse voltage			170	V	
$I_{F(RMS)}$	RMS forward current			30	A	
$I_{F(AV)}$	Average forward current $\delta = 0.5$	TO-220FPAB	$T_c = 120\text{ }^\circ\text{C}$	Per diode	15	A
		TO-220AB / D ² PAK	$T_c = 155\text{ }^\circ\text{C}$	Per device		
		TO-247			30	
I_{FSM}	Surge non repetitive forward current		$t_p = 10\text{ms}$ sinusoidal	220	A	
P_{ARM}	Repetitive peak avalanche power		$t_p = 1\mu\text{s}$ $T_j = 25\text{ }^\circ\text{C}$	10500	W	
T_{stg}	Storage temperature range			-65 to + 175	$^\circ\text{C}$	
T_j	Maximum operating junction temperature *			175	$^\circ\text{C}$	
dV/dt	Critical rate of rise of reverse voltage			10000	V/ μs	

* : $\frac{dP_{tot}}{dT_j} > \frac{1}{R_{th(j-a)}}$ thermal runaway condition for a diode on its own heatsink

Table 4: Thermal Parameters

Symbol	Parameter			Value	Unit
$R_{th(j-c)}$	Junction to case	TO-220FPAB	Per diode	4	$^\circ\text{C/W}$
			Total	3.3	
		TO-220AB / D ² PAK	Per diode	1.6	
		Total	0.85		
		TO-247	Per diode	1.5	
			Total	0.8	
$R_{th(c)}$		TO-220FPAB	Coupling	2.6	$^\circ\text{C/W}$
		TO-220AB / D ² PAK	Coupling	0.3	
		TO-247	Coupling	0.3	

When the diodes 1 and 2 are used simultaneously:

$$\Delta T_j(\text{diode } 1) = P(\text{diode } 1) \times R_{th(j-c)}(\text{Per diode}) + P(\text{diode } 2) \times R_{th(c)}$$

Table 5: Static Electrical Characteristics (per diode)

Symbol	Parameter	Tests conditions		Min.	Typ	Max.	Unit
I_R *	Reverse leakage current	$T_j = 25\text{ }^\circ\text{C}$	$V_R = V_{RRM}$			20	μA
		$T_j = 125\text{ }^\circ\text{C}$			5	20	mA
V_F **	Forward voltage drop	$T_j = 25\text{ }^\circ\text{C}$	$I_F = 15\text{ A}$			0.92	V
		$T_j = 125\text{ }^\circ\text{C}$			0.69	0.75	
		$T_j = 25\text{ }^\circ\text{C}$	$I_F = 30\text{ A}$			1	
		$T_j = 125\text{ }^\circ\text{C}$			0.80	0.86	

Pulse test: * $t_p = 5\text{ ms}$, $\delta < 2\%$

** $t_p = 380\text{ }\mu\text{s}$, $\delta < 2\%$

To evaluate the conduction losses use the following equation: $P = 0.64 \times I_{F(AV)} + 0.0073 I_{F(RMS)}^2$

Figure 1: Average forward power dissipation versus average forward current (per diode)

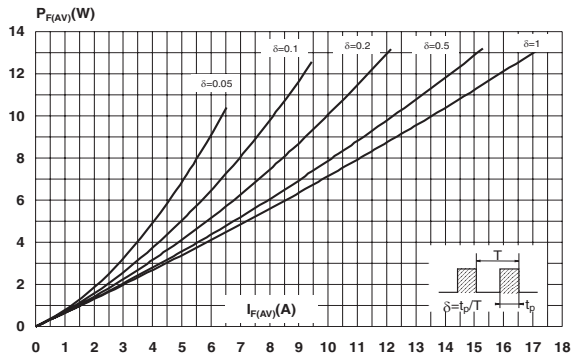

Figure 2: Average forward current versus ambient temperature ($\delta = 0.5$, per diode)

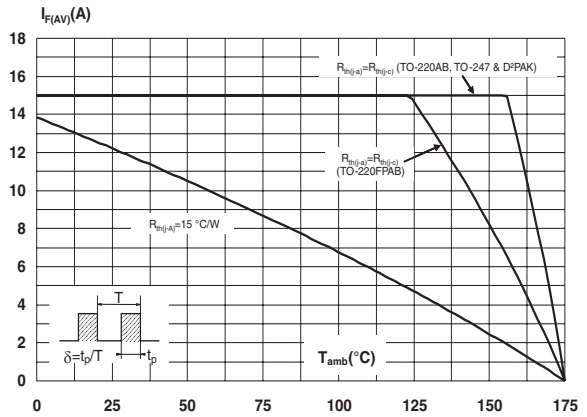

Figure 3: Normalized avalanche power derating versus pulse duration

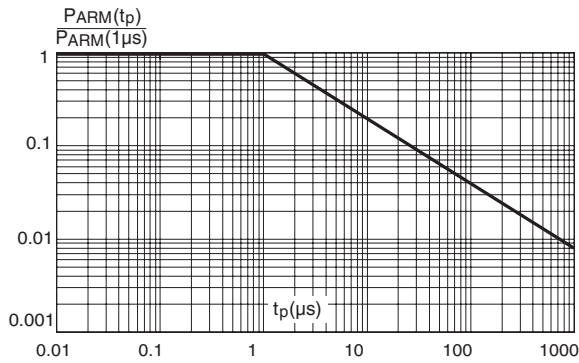

Figure 4: Normalized avalanche power derating versus junction temperature

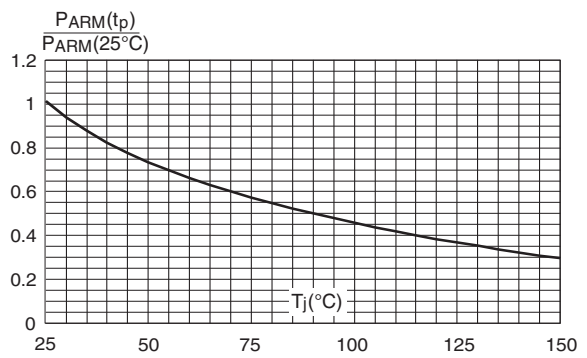

Figure 5: Non repetitive surge peak forward current versus overload duration (maximum values, per diode) (TO-220AB, TO-247, D²PAK)

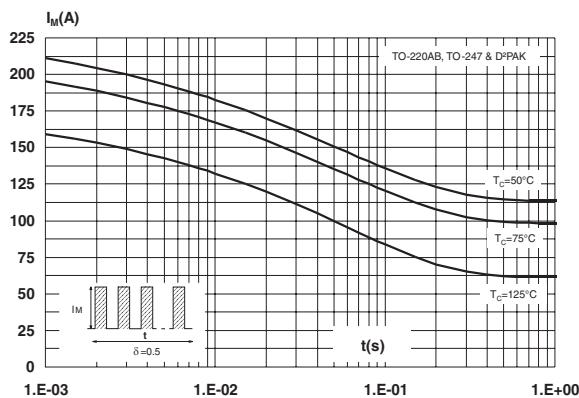

Figure 6: Non repetitive surge peak forward current versus overload duration (maximum values, per diode) (TO-220FPAB)

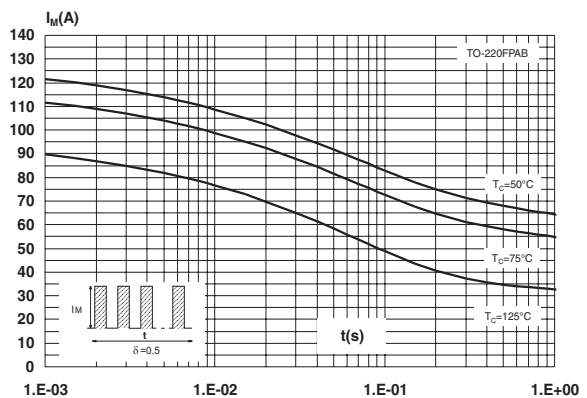

Figure 7: Relative variation of thermal impedance junction to case versus pulse duration (per diode) (TO-220AB, TO-247, D²PAK)

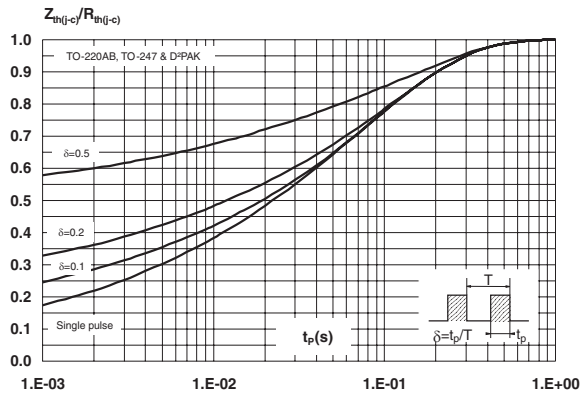

Figure 8: Relative variation of thermal impedance junction to case versus pulse duration (per diode) (TO-220FPAB)

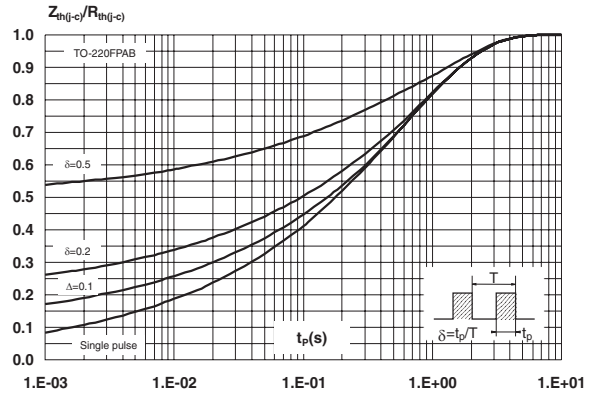

Figure 9: Reverse leakage current versus reverse voltage applied (typical values, per diode)

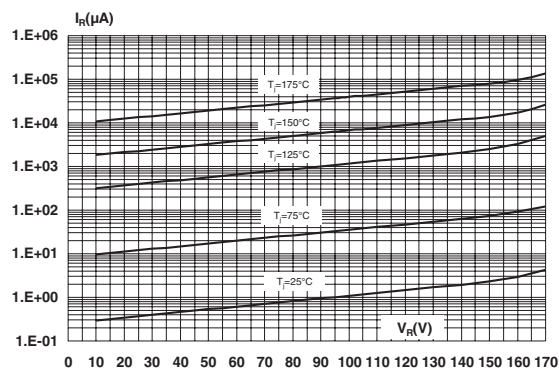

Figure 10: Junction capacitance versus reverse voltage applied (typical values, per diode)

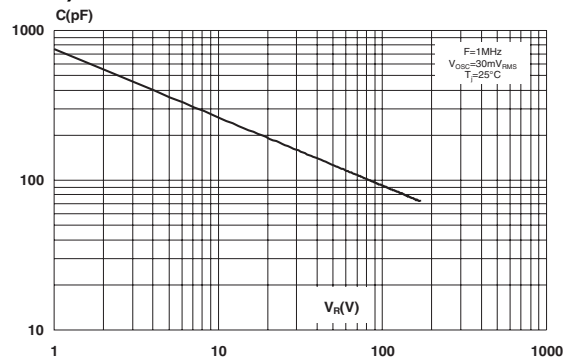

Figure 11: Forward voltage drop versus forward current (maximum values, per diode, low level)

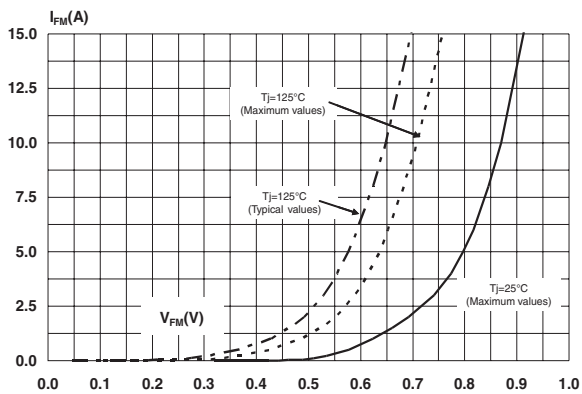

Figure 12: Forward voltage drop versus forward current (maximum values, per diode, high level)

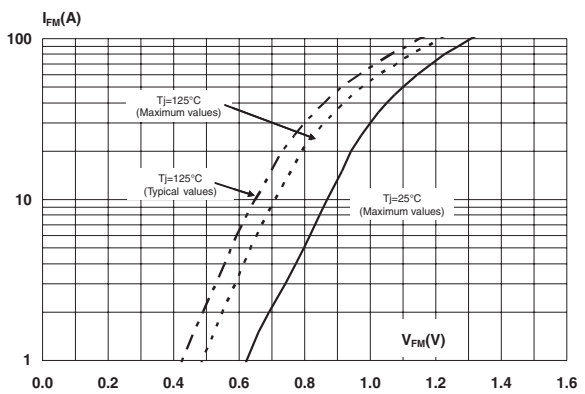

Figure 13: Thermal resistance junction to ambient versus copper surface under tab (Epoxy printed circuit board, copper thickness: 35 μm) (D²PAK)

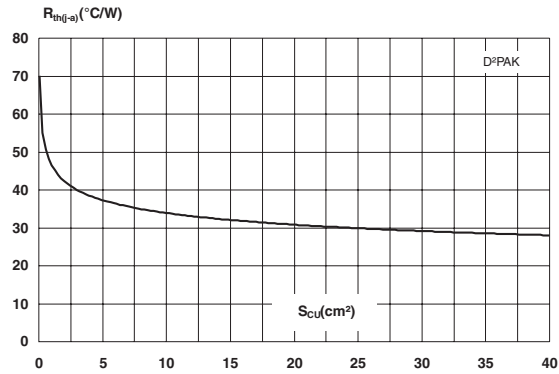

Figure 14: TO-247 Package Mechanical Data

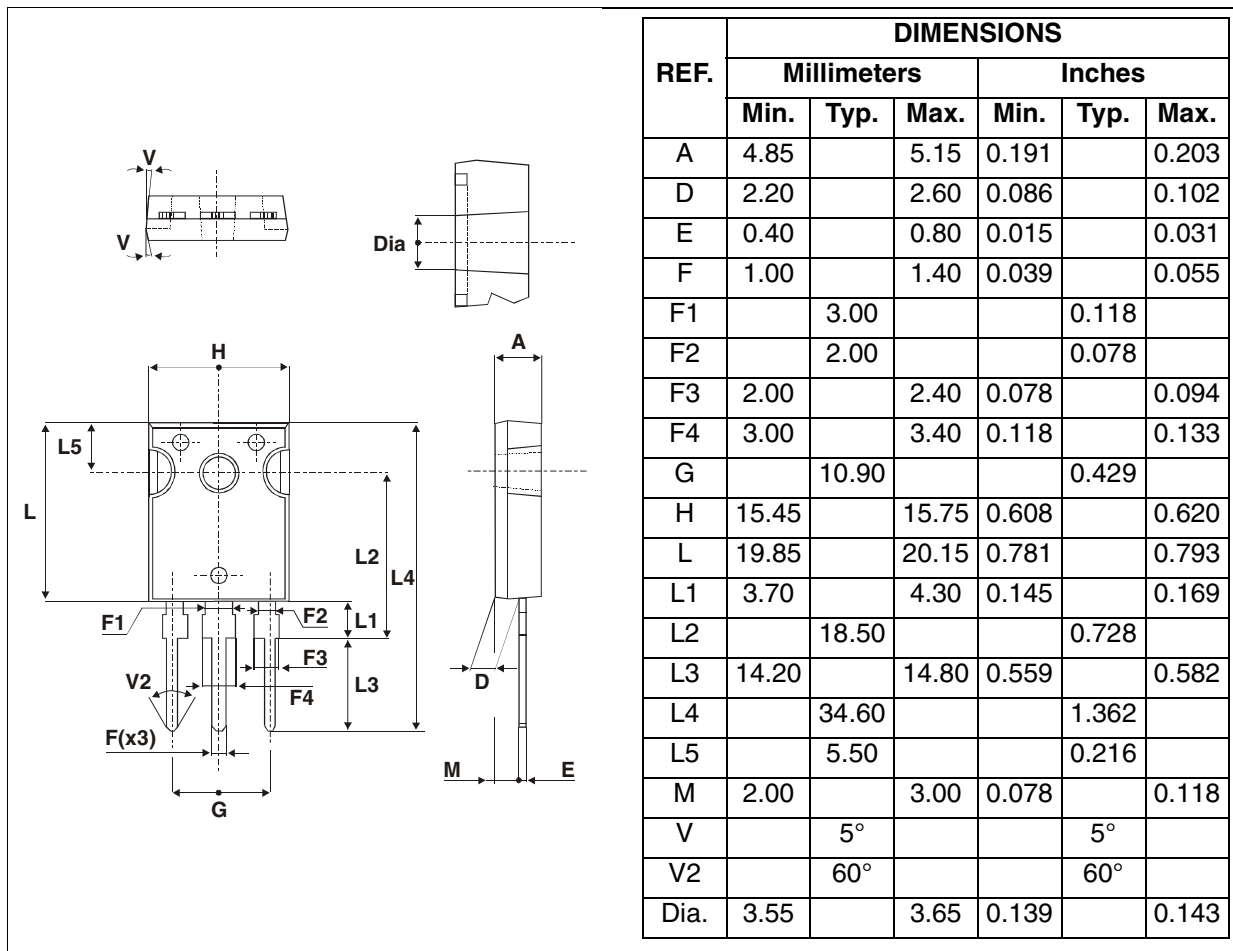

Figure 15: D²PAK Package Mechanical Data

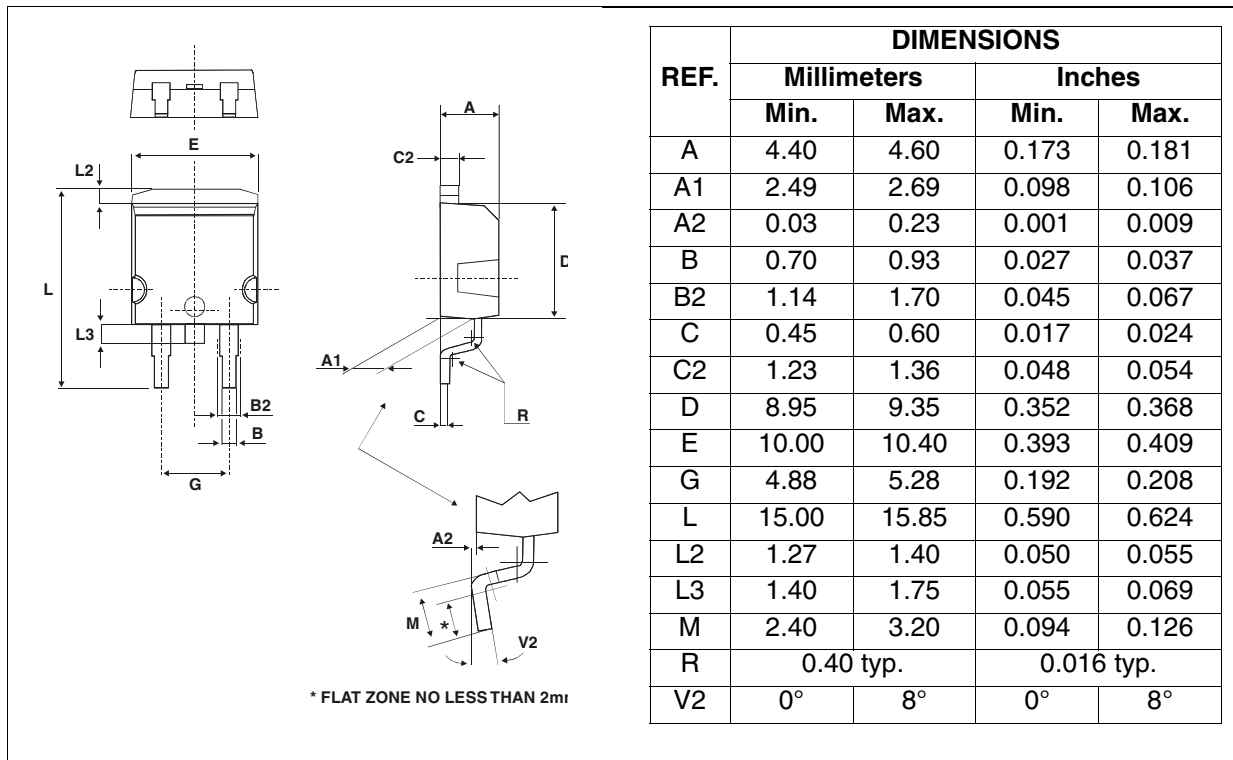

Figure 16: Foot Print Dimensions (in millimeters)

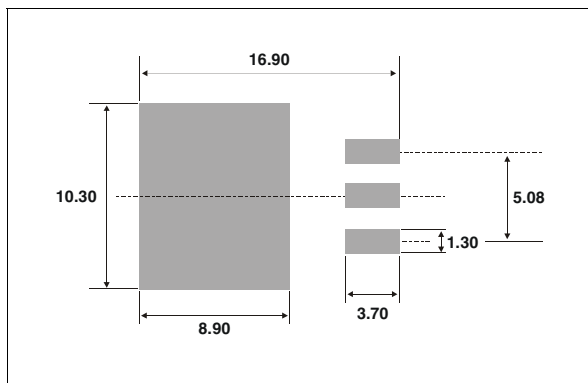

Figure 17: TO-220FPAB Package Mechanical Data

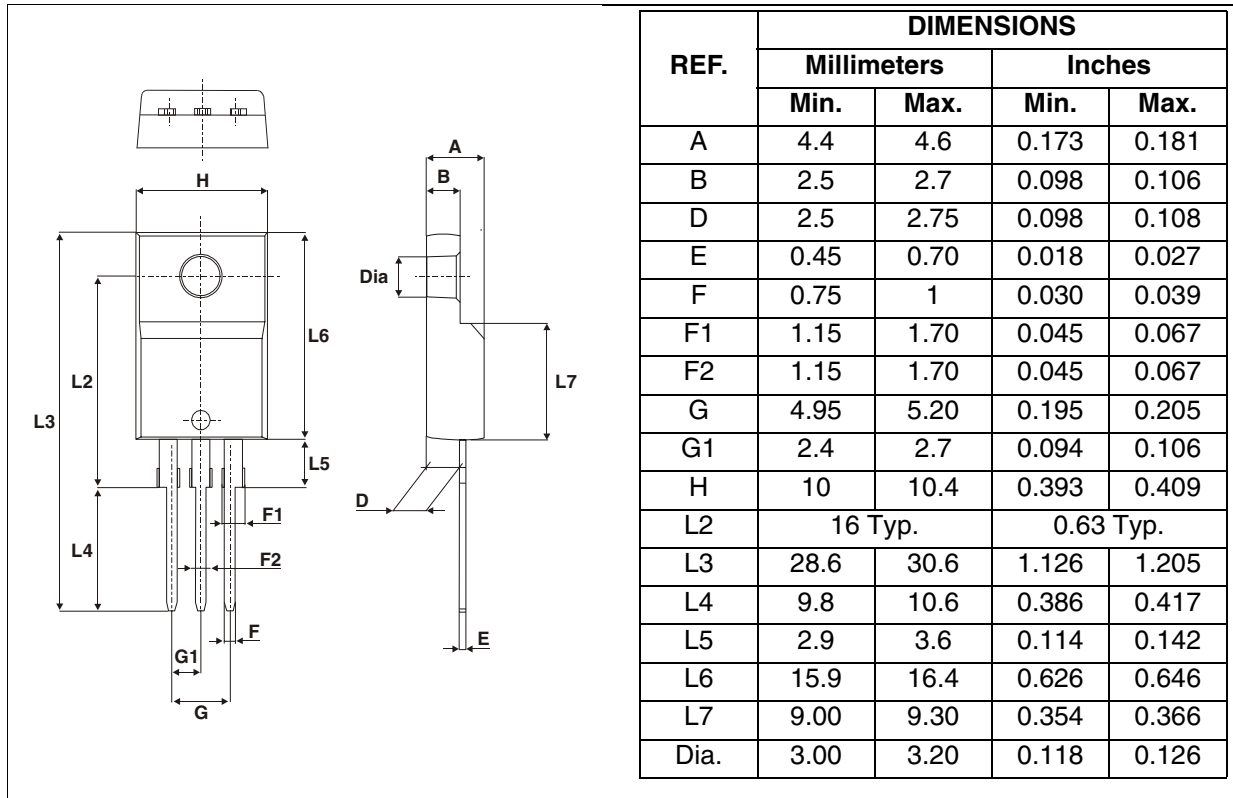
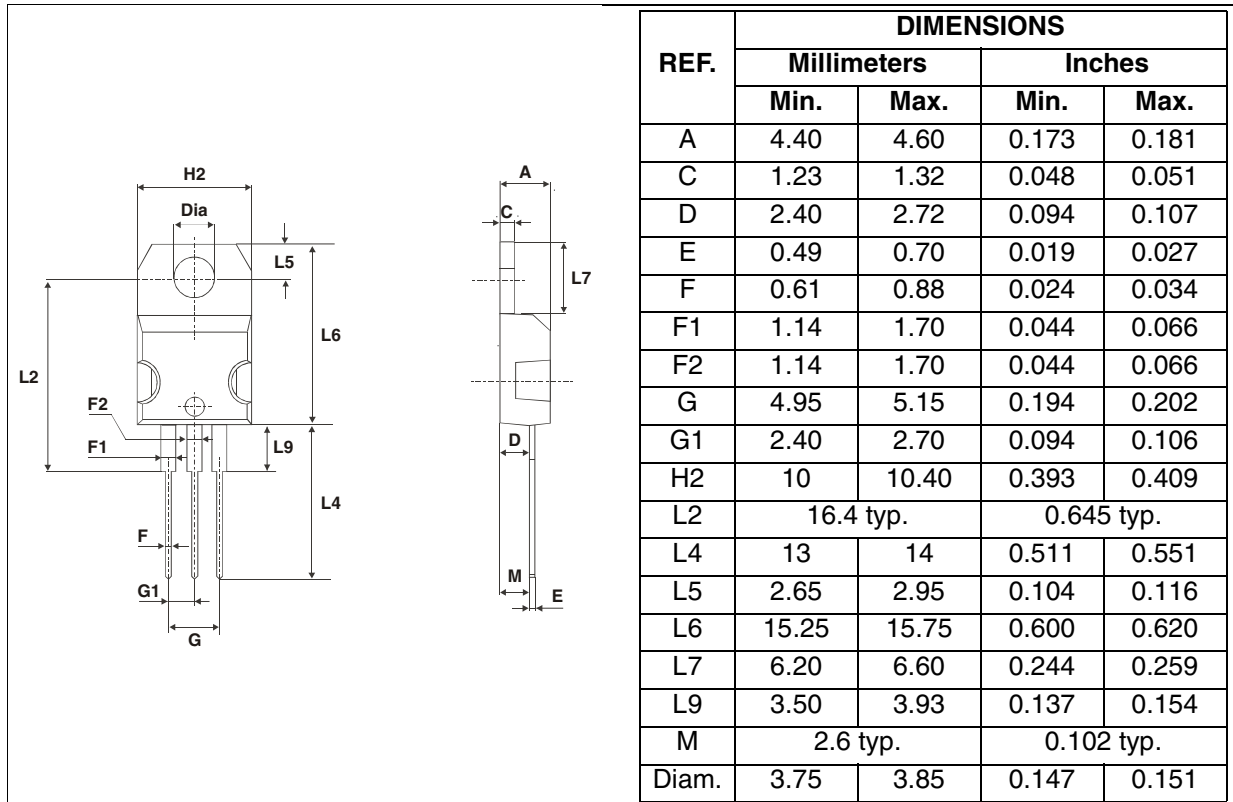

Figure 18: TO-220AB Package Mechanical Data



STPS30170C

In order to meet environmental requirements, ST offers these devices in ECOPACK® packages. These packages have a Lead-free second level interconnect . The category of second level interconnect is marked on the package and on the inner box label, in compliance with JEDEC Standard JESD97. The maximum ratings related to soldering conditions are also marked on the inner box label. ECOPACK is an ST trademark. ECOPACK specifications are available at: www.st.com.

Table 6: Ordering Information

Ordering type	Marking	Package	Weight	Base qty	Delivery mode
STPS30170CW	STPS30170CW	TO-247	4.40 g	30	Tube
STPS30170CT	STPS30170CT	TO-220AB	2 g	50	Tube
STPS30170CFP	STPS30170CFP	TO-220FPAB	1.9 g	50	Tube
STPS30170CG	STPS30170CG	D ² PAK	1.48 g	50	Tube
STPS30170CG-TR	STPS30170CG			1000	Tape & reel

- Epoxy meets UL94, V0
- Cooling method: by conduction (C)
- TO-220 - Recommended torque value: 0.55 Nm, Maximum torque value: 0.7 Nm.
- TO-247 - Recommended torque value: 0.8 Nm, Maximum torque value: 1.0 Nm.

Table 7: Revision History

Date	Revision	Description of Changes
16-Sep-2005	1	First issue.

Information furnished is believed to be accurate and reliable. However, STMicroelectronics assumes no responsibility for the consequences of use of such information nor for any infringement of patents or other rights of third parties which may result from its use. No license is granted by implication or otherwise under any patent or patent rights of STMicroelectronics. Specifications mentioned in this publication are subject to change without notice. This publication supersedes and replaces all information previously supplied. STMicroelectronics products are not authorized for use as critical components in life support devices or systems without express written approval of STMicroelectronics.

The ST logo is a registered trademark of STMicroelectronics.
All other names are the property of their respective owners

© 2005 STMicroelectronics - All rights reserved

STMicroelectronics group of companies

Australia - Belgium - Brazil - Canada - China - Czech Republic - Finland - France - Germany - Hong Kong - India - Israel - Italy - Japan -
Malaysia - Malta - Morocco - Singapore - Spain - Sweden - Switzerland - United Kingdom - United States of America
www.st.com