

REV
NC 1011-052-1205
055

REVISIONS			
SYM	DESCRIPTION	DATE	APPROVED
NC	NEW RELEASE PER E.O. P18260	8-22-03	ADR

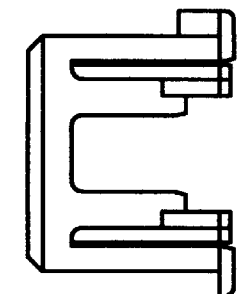

VIEW SHOWS KEY -A- AS REFERENCE.

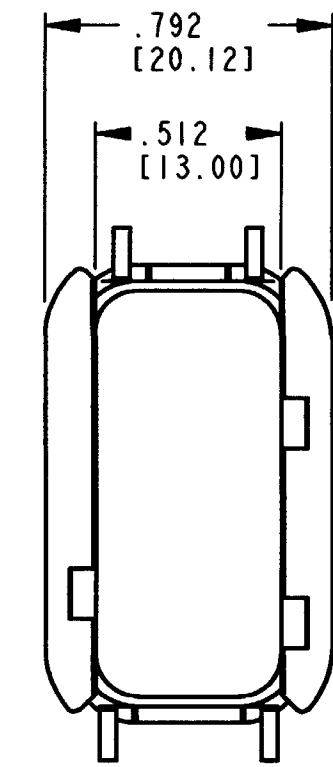
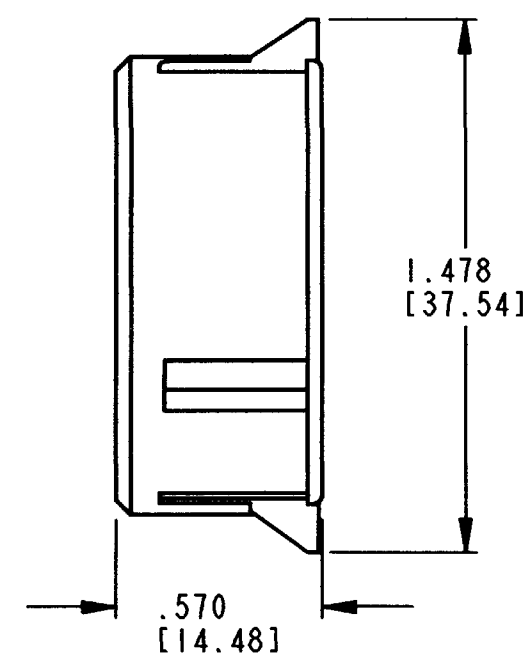

- 6. SEE NEXT SHEET FOR COLOR OF MATERIAL AND KEY ARRANGEMENT.
 - 5. ASSEMBLE SLEEVE RETAINER AS SHOWN. SNAP SLEEVE RETAINER INTO RECEPTACLE. VERIFY SLEEVE RETAINER RETENTION FINGERS ARE FULLY SEATED BEHIND RECEPTACLE LATCH BUMPS. RECEPTACLE AND INTERFACE SEAL SHOWN FOR REFERENCE ONLY.
 - 4. MATERIAL: PLASTIC
 - 3. PART DESIGNED TO FIT DTM04-12P*-**** (* = A,B,C,D KEYS) (**** = ALL MODIFICATIONS). CONSULT FACTORY FOR MODIFICATIONS.
 - 2. DIMENSIONS ARE ±.025 [.64]
 - 1. DIMENSIONS ARE IN INCHES [mm]
- NOTES: UNLESS OTHERWISE SPECIFIED

SIGNATURE & DATE	
DR	V. TOMSA AUG-8-03.
CHK	B. Byford 8/19/03
PE	Vladimir Tomsa 8/11/03
APPD	D. Meyer 8/12/03
SCALE	NONE

SLEEVE RETAINER FOR 12 PIN RECEPTACLE DTM SERIES

ENVELOPE

CP	MATL. CODE
The Deutch Company DEUTSCH I.P.D. 3850 INDUSTRIAL AVE. HEMET, CALIF. 92545	
B	1011-052-1205
DWG SIZE 11139	SHEET 1 OF 2

REV
NC 1011-052-1205
055

REVISIONS			
SYM	DESCRIPTION	DATE	APPROVED
	SEE PREVIOUS SHEET.	8-22-03	RDR

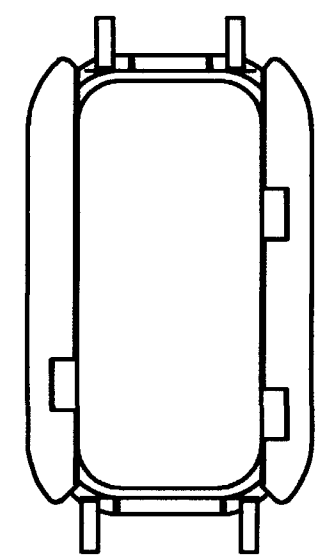

1011-052-1205
KEY -A-
GREY

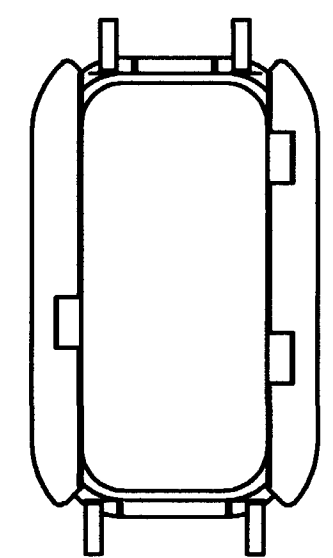

1011-053-1205
KEY -B-
BLACK

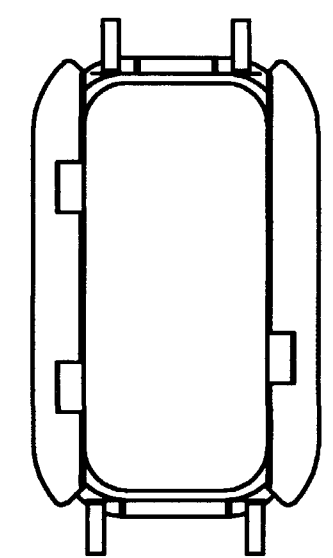

1011-054-1205
KEY -C-
GREEN

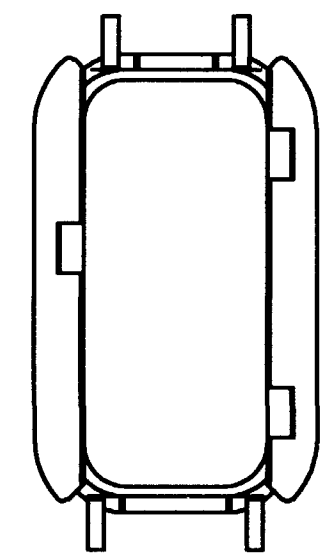

1011-055-1205
KEY -D-
BROWN

NOTES:

SIGNATURE & DATE	
DR	V. TOMSA AUG-8-03.
CHK	B. Byrd 8/19/03
PE	Vladimir Tomasa AV41-03
APPD	D. Meyer 8/12/03
SCALE	1:1

SLEEVE RETAINER
FOR 12 PIN RECEPTACLE
DTM SERIES

ENVELOPE

CP	MATERIAL CODE	
The Deutsch Company DEUTSCH I.P.D. 3850 INDUSTRIAL AVE. HEMET, CALIF. 92545		
B	1011-052-1205	
	CODE 11139	SHEET 2 OF 2