

RECOMMENDED P.C.B. LAYOUT (T=1.6mm/2.0mm/2.4mm)

NOTES:

1. MATERIAL:

HOUSING: THERMAL PLASTIC, UL94V-0, COLOR: SEE SHEET2
 TERMINAL/PEG: COPPER ALLOY, THICKNESS=0.25MM

2. TERMINAL PLATING:

CONTACT AREA: (a) GOLD FLASH
 (b) 0.76 MICRON GOLD PLATED
 (c) 0.38 MICRON GOLD PLATED

SOLDER TAIL:

1.27 MICRON MIN. MATTE TIN PLATED

UNDER PLATE:

1.27 MICRON MIN. NICKEL PLATED

3. PEG PLATING:

1.27 MICRON MIN. MATTE TIN PLATED OVERALL
 1.27 MICRON MIN. NICKEL UNDER PLATED

4. PACKAGING SPECIFICATION REFER TO PK-67491-001

5. PRODUCT SPECIFICATION REFER TO PS-67491-001

6. MATING PART: 67489

7. RECOMMENDED PROCESS: WAVE SOLDERING

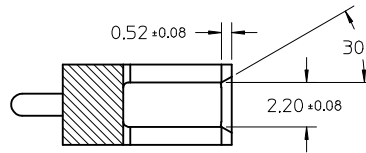
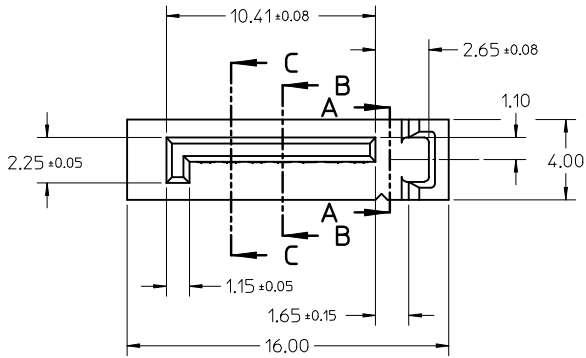

SECTION A-A

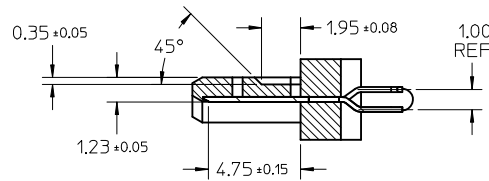

SECTION B-B

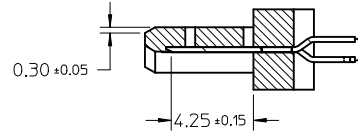

SECTION C-C

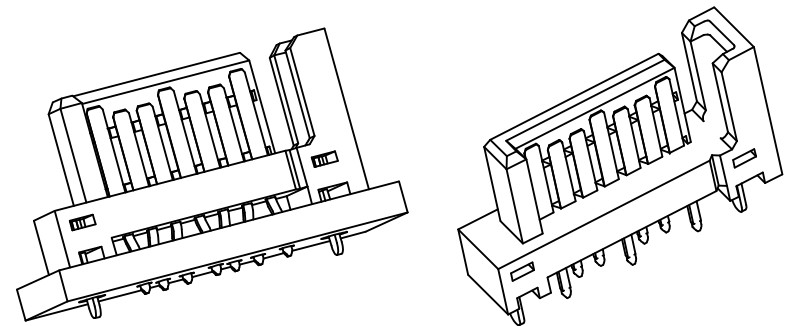
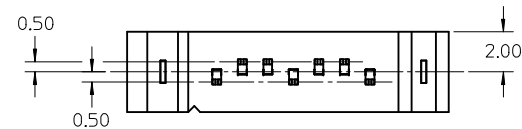
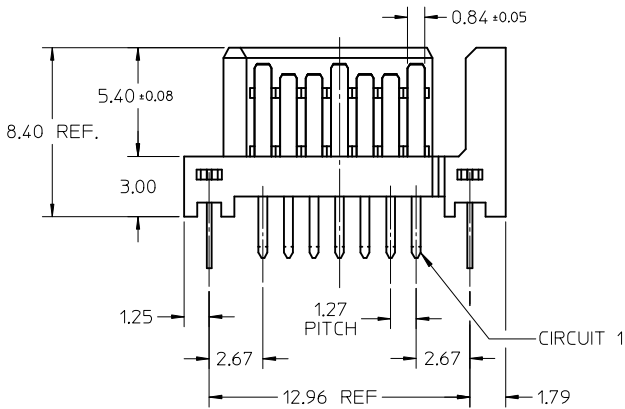

SEE SHEET 2 EC NO: S2017-0539 DRW:DBFAN 2017/04/12 CHKD:JKACHLIC 2017/04/12 APPR:JKACHLIC 2017/04/12	QUALITY SYMBOLS $F_A=0$ $F_B=0$ $F_C=0$	GENERAL TOLERANCES (UNLESS SPECIFIED)		DIMENSION STYLE MM ONLY		SCALE 4:1	DESIGN UNITS METRIC	THIRD ANGLE PROJECTION	
			mm	INCH	DRAWN BY GRATE MA	DATE 2004/02/02	TITLE 1.27MM HIGH SPEED PLUG VERTICAL TYPE		
		4 PLACES	± ---	± ---	CHECKED BY YAJUN	DATE 2004/02/02			
			mm	INCH	APPROVED BY RZHANG		DATE 2010/11/03	MOLEX INCORPORATED DOCUMENT NO. SD-67491-001	
3 PLACES	± ---	± ---	MATERIAL NO.		SHEET NO. 1 OF 2				
	mm	INCH	ANGULAR ± 3°		SEE SHEET 2				
DRAFT WHERE APPLICABLE MUST REMAIN WITHIN DIMENSIONS			THIS DRAWING CONTAINS INFORMATION THAT IS PROPRIETARY TO MOLEX INCORPORATED AND SHOULD NOT BE USED WITHOUT WRITTEN PERMISSION						

	10	9	8	7	6	5	4	3	2	1
	P/N	PLATING TYPE	DIM "A"	DIM "B"	COLOR	SOLDE AREA PLATING				
F	67491-0020	SEE NOTE 2(a)	2.05	2.57	BLACK	PURE TIN MATTE FINISH				
	67491-0021	SEE NOTE 2(b)								
	67491-0022	SEE NOTE 2(c)								
	67491-0025	SEE NOTE 2(a)	2.35							
	67491-2020	SEE NOTE 2(a)	2.05	2.57	BLUE, PANTONE NO. 293C ΔE<3					
	67491-2021	SEE NOTE 2(b)								
E	67491-2025	SEE NOTE 2(a)	2.35							
	67491-2027	SEE NOTE 2(c)								
	67491-3010	SEE NOTE 2(a)	3.00	3.20	BLACK					
	67491-3011	SEE NOTE 2(b)								
	67491-3012	SEE NOTE 2(c)								
	67491-3110	SEE NOTE 2(a)	3.00	3.20	BLUE, PANTONE NO. 293C ΔE<3					

ADD DIM "B" AT F8 EC NO: S2017-0539 DRW:DBFAN 2017/04/12 CHKD:JKACHLIC 2017/04/12 APPR:JKACHLIC 2017/04/12	QUALITY SYMBOLS F=0 E=0 B=0	GENERAL TOLERANCES (UNLESS SPECIFIED)		DIMENSION STYLE MM ONLY		SCALE 4:1	DESIGN UNITS METRIC	THIRD ANGLE PROJECTION		
			mm	INCH	DRAWN BY GRATE MA	DATE 2004/02/02	TITLE 1.27MM HIGH SPEED PLUG VERTICAL TYPE			
		4 PLACES	± ---	± ---	CHECKED BY YA JUN	DATE 2004/02/02				
		3 PLACES	± ---	± ---	APPROVED BY RZHANG	DATE 2010/11/03	MOLEX INCORPORATED			
2 PLACES	± 0.15	± ---	MATERIAL NO. SEE CHART		DOCUMENT NO. SD-67491-001	SHEET NO. 2 OF 2				
1 PLACE	± 0.25	± ---	DRAFT WHERE APPLICABLE MUST REMAIN WITHIN DIMENSIONS		THIS DRAWING CONTAINS INFORMATION THAT IS PROPRIETARY TO MOLEX INCORPORATED AND SHOULD NOT BE USED WITHOUT WRITTEN PERMISSION					
ANGULAR ± 3 °										