

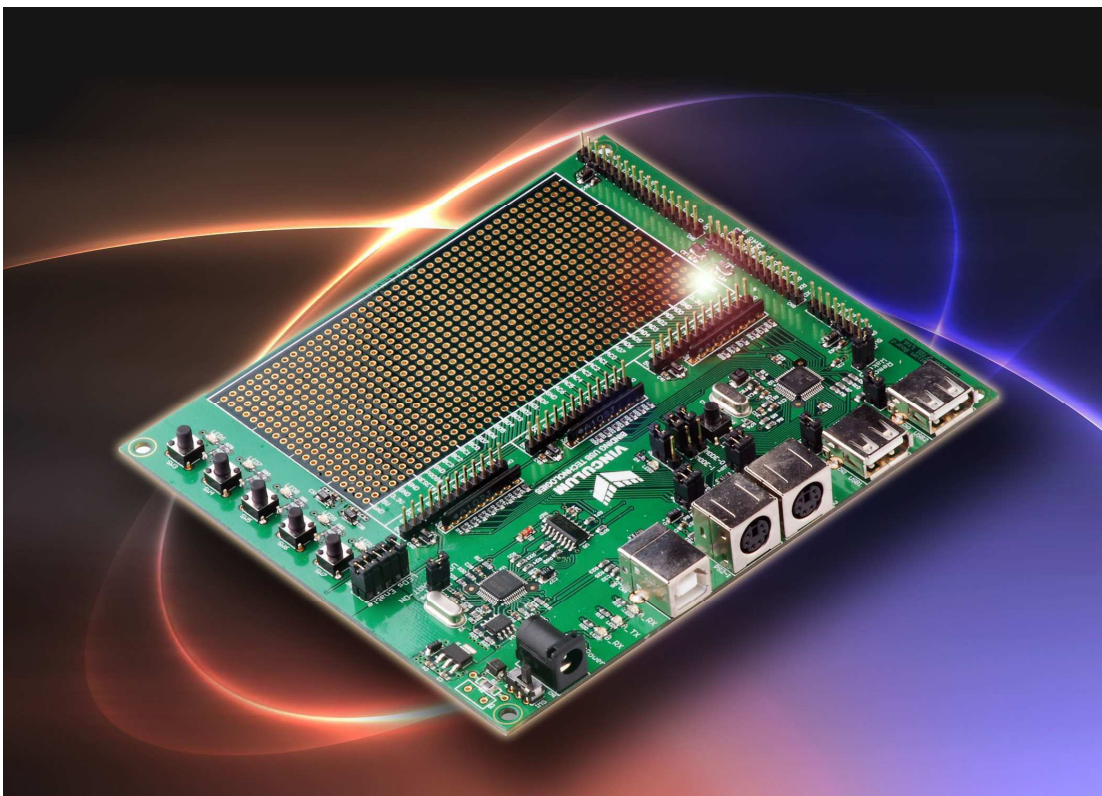

Future Technology Devices International Ltd

V-Eval Board



Document Version 1.0

Future Technology Devices International Ltd (FTDI)

373 Scotland Street, Glasgow G5 8QB United Kingdom

Tel.: +44 (0) 141 429 2777 Fax: + 44 (0) 141 429 2758

E-Mail (Support): vinculum.support@ftdichip.com Web: <http://www.vinculum.com>

Vinculum is part of Future Technology Devices International Ltd. Neither the whole nor any part of the information contained in, or the product described in this manual, may be adapted or reproduced in any material or electronic form without the prior written consent of the copyright holder. This product and its documentation are supplied on an as-is basis and no warranty as to their suitability for any particular purpose is either made or implied. Future Technology Devices International Ltd will not accept any claim for damages howsoever arising as a result of use or failure of this product. Your statutory rights are not affected. This product or any variant of it is not intended for use in any medical appliance, device or system in which the failure of the product might reasonably be expected to result in personal injury. This document provides preliminary information that may be subject to change without notice. No freedom to use patents or other intellectual property rights is implied by the publication of this document. Future Technology Devices International Ltd, 373 Scotland Street, Glasgow G5 8QB United Kingdom. Scotland Registered Number: SC136640

Table of Contents

1	Introduction	6
1.1	Handling the board	6
1.2	Environmental requirements	6
2	Board description	7
2.1	V-Eval Board features	7
2.2	Specifications	7
3	V-Eval Board components and interfaces.	8
3.1	Block Diagram	9
3.2	Functional Block Description.....	10
3.2.1	Components.....	10
3.2.2	Interfaces.	11
4	Testing the board.	12
5	Detailed description of board components.	13
5.1	Power select jumper JP9.....	13
5.2	ADBUS port connector CN6.....	14
5.3	ACBUS connector CN8.....	15
5.4	BDBUS port connector CN11.....	16
5.5	UART interface connector CN9.....	17
5.6	SPI interface connector CN12.....	18
5.7	FIFO interface connector CN5	19
5.8	Prototyping area	20
5.9	USB1 interface CN2	22
5.10	USB2 interface CN3.	22
5.11	PS2-1 interface. CN10.	23
5.12	PS2-2 interface. CN7.	24
5.13	Monitor port mode select jumpers JP1, JP2	25
5.14	User LEDs. LED6 – LED10.....	26
5.15	LED enable/disable jumpers JP10 – JP14.....	26
5.16	User push button switches	27
5.17	Host USB power jumpers JP15, JP16.	27
5.18	PS2-1, PS2-2 Enable jumpers JP4, JP5, JP5, JP6.	28
5.19	Remote Wakeup jumper JP3.	28
5.20	Reset Push-button Switch	29
5.21	'PROG' LED	29
6	Connecting to host PC	30
6.1	Drivers installation.....	30
7	V-Eval Board Control Panel application.....	34
7.1	Terminal Mode	34



VINCULUM

7.1.1	'Options - Mode' tab.....	34
7.1.2	Options - 'RS232 Setup' tab:	35
7.1.3	Options - 'Disk Transfer' tab.....	36
7.1.4	Options - 'Slave File I/O' tab	37
7.2	Spy Mode	38
7.3	Programming Mode.....	39
8	V-Eval Board Schematics.	40
9	Contact Information.....	41

List of Tables

Table 1.0	Document references.....	5
Table 1-1	Acronyms and Abbreviations	Error! Bookmark not defined.
Table 4-1	ADBUS port connector CN6.	14
Table 4-2	ACBUS port connector CN8	15
Table 4-3	BDBUS port connector CN11	16
Table 4-4	UART interface connector CN9	17
Table 4-5	SPI Interface connector CN12	18
Table 4-6	FIFO Interface connector CN5.....	19
Table 4-7	Prototyping area	21
Table 4-8	USB1 host/slave connector. CN2	22
Table 4-9	USB2 host/slave connector. CN3	22
Table 4-10	PS2-1 connector. CN10	23
Table 4-11	PS2 - 2 connector. CN7	24
Table 4-12	Monitor interface type selection jumpers JP1, JP2.....	25
Table 4-13	User LEDs connections.....	26
Table 4-14	LED Enable/Disable jumpers.	26
Table 4-15	User Switches	27
Table 4-16	PS2 enable jumpers.....	28

List of Figures

Figure 3-1	Board layout.	8
Figure 3-2	Block diagram.	9
Figure 4-1	Power connector.	12
Figure 5-1	Power select jumper.	13
Figure 5-2	ADBUS port connector.	14
Figure 5-3	ACBUS port connector CN8.	15
Figure 5-4	BDBUS port connector CN11.	16
Figure 5-5	UART interface connector CN9.	17
Figure 5-6	SPI interface connector CN12.	18
Figure 5-7	FIFO interface connector CN5.	19
Figure 5-8	Prototyping area.	20
Figure 5-9	USB1 interface CN2.	22
Figure 5-10	USB2 interface CN3.	22
Figure 5-11	PS2 - 1 interface CN10.	23
Figure 5-12	PS2 - 2 interface CN7.	24
Figure 5-13	Monitor mode select jumpers JP1, JP2.	25
Figure 5-14	User LEDs.	26
Figure 5-15	LED Enable/Disable jumpers.	26
Figure 5-16	User push button switches.	27
Figure 5-17	USB power enable jumpers.	27
Figure 5-18	USB power enable jumpers.	28
Figure 5-19	Remote Wakeup jumper.	28
Figure 5-20	Reset Switch.	29
Figure 5-21	LED 'PROG'.	29
Figure 6-1	Drivers installation.	30
Figure 6-2	Drivers installation.	30
Figure 6-3	Drivers installation.	31
Figure 6-4	Drivers installation.	31
Figure 6-5	Drivers installation.	32
Figure 6-6	Drivers installation.	32
Figure 7-1	Control Panel – Terminal mode.	34
Figure 7-2	Control Panel – Options – RS232 Setup.	35
Figure 7-3	Control Panel – Options – Disk Transfer.	36
Figure 7-4	Control Panel – Options – Slave File I/O.	37
Figure 7-5	Control Panel – Spy Mode.	38
Figure 7-6	Control Panel – Programming Mode.	39

Reference

This document does not describe the hardware interfaces required to connect a microcontroller to a VNC1L device, nor does it provide application notes. The following documents are available from FTDI and other sources for this purpose:

Document reference	Description
Vinculum Website	The main website for the Vinculum family of USB Host Controllers http://www.vinculum.com
DS_VNC1L-1A	Vinculum Embedded USB Host Controller IC Data Sheet http://www.vinculum.com
Vinculum Firmware User Manual	Vinculum Embedded USB Host Controller IC Firmware User Manual http://www.vinculum.com
FTDI FT2232	FT2232D Data Sheet http://www.ftdichip.com
USB 2.0	Universal Serial Bus Specification Revision 2.0 USB Implementers Forum http://www.usb.org

Table 1.0 Document references.

1 Introduction

The V-Eval Kit is a hardware platform that designers can use to develop embedded USB host systems based on FTDI's VNC1L devices.

Features include:

- Inbuilt VNC1L USB device programmer / terminal emulator / command monitor hardware.
- Two VNC1L USB Host / Slave ports.
- Generous Prototyping area for standard DIP and SIL devices.
- Multiple IO port connectors grouped by port name and/or function.
- LEDs and switches for user interaction.
- PS/2 keyboard and mouse ports.
- Downloadable programming, terminal emulation and debug monitor software.
- Downloadable HID class example project (VNC1L controlled USB Rocket Launcher) including PIC source code in "C".

The V-Eval kit includes the following hardware items as standard

- 1 x V-Eval development board.
- 1 x 5V/1A universal plug top PSU – UK, US, European and Japanese versions available.
- 1 x USB A/B cable to connect to a host PC in programming / terminal emulation or debugging modes.
- 1 x USB gender changer for USB slave mode applications.

Before you proceed please check that all the contents of the package are not damaged.

Ensure that your kit includes a proper version of power supply, depending on the region where you live

V-Eval application software and project examples can be downloaded from:

www.vinculum.com/prd_v-eval.htm

1.1 Handling the board

Static discharge precaution – Without proper anti-static handling the board can be damaged. Therefore, take anti-static precautions while handling the board.

1.2 Environmental requirements

The V-Eval Board must be stored between -40°C and 80°C. The recommended operating temperature is between 0°C and 55°C

2 Board description

V-Eval Board is intended to use as a hardware platform for easy evaluation of FTDI's Vinculum VNC1 series embedded USB host devices. The V-Eval Board includes all the components you need to start developing USB host systems based on VNC1L devices.

2.1 V-Eval Board features

- VNC1L – Embedded USB host chip
- Two USB type A connectors for connecting to USB slave peripherals
- VNC1L IO port connectors grouped by port name and/or function.
- PS/2 Keyboard and Mouse connectors
- FT2232D – dual USB-UART device for VNC1L programming & debug functions
- One USB type B connector for PC host connection to FT2232D.
- Five user-programmable LEDs. Two of them are driven by default firmware.
- Five user-programmable push-button switches.

2.2 Specifications

- Board supply voltage: 4.75V ... 5.25V
- Board supply current: 60mA (with no USB devices on USB1 or USB2 port)
- IO connectors power output: 5V/150mA, 3.3V/150mA
- Dimensions: 130mm x 146mm x 15mm (L x W x H)

3 V-Eval Board components and interfaces.

This chapter describes the operational and connectivity information for V-Eval Board major components and interfaces.

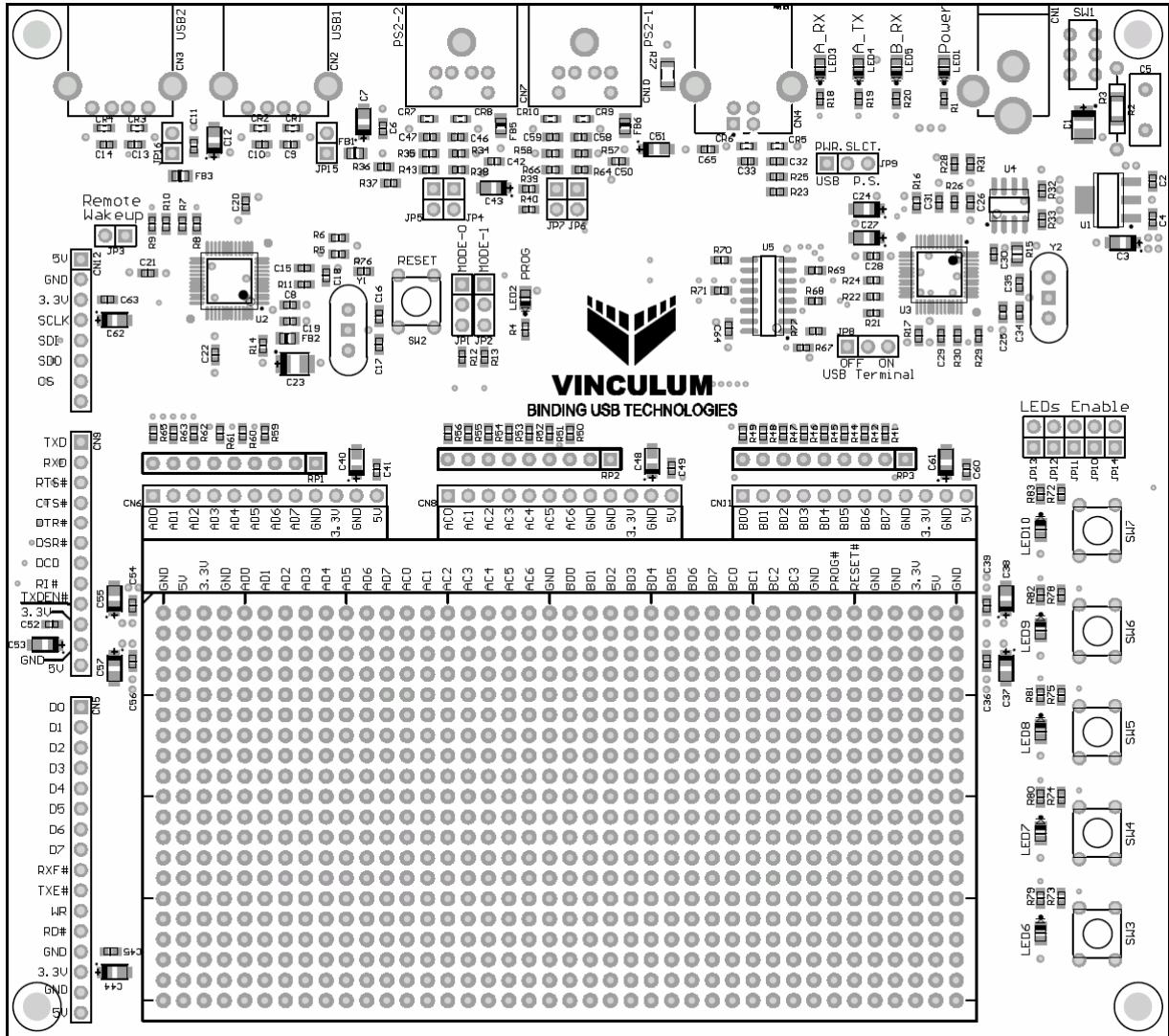

Figure 3-1 V-Eval Board layout.

3.1 Block Diagram

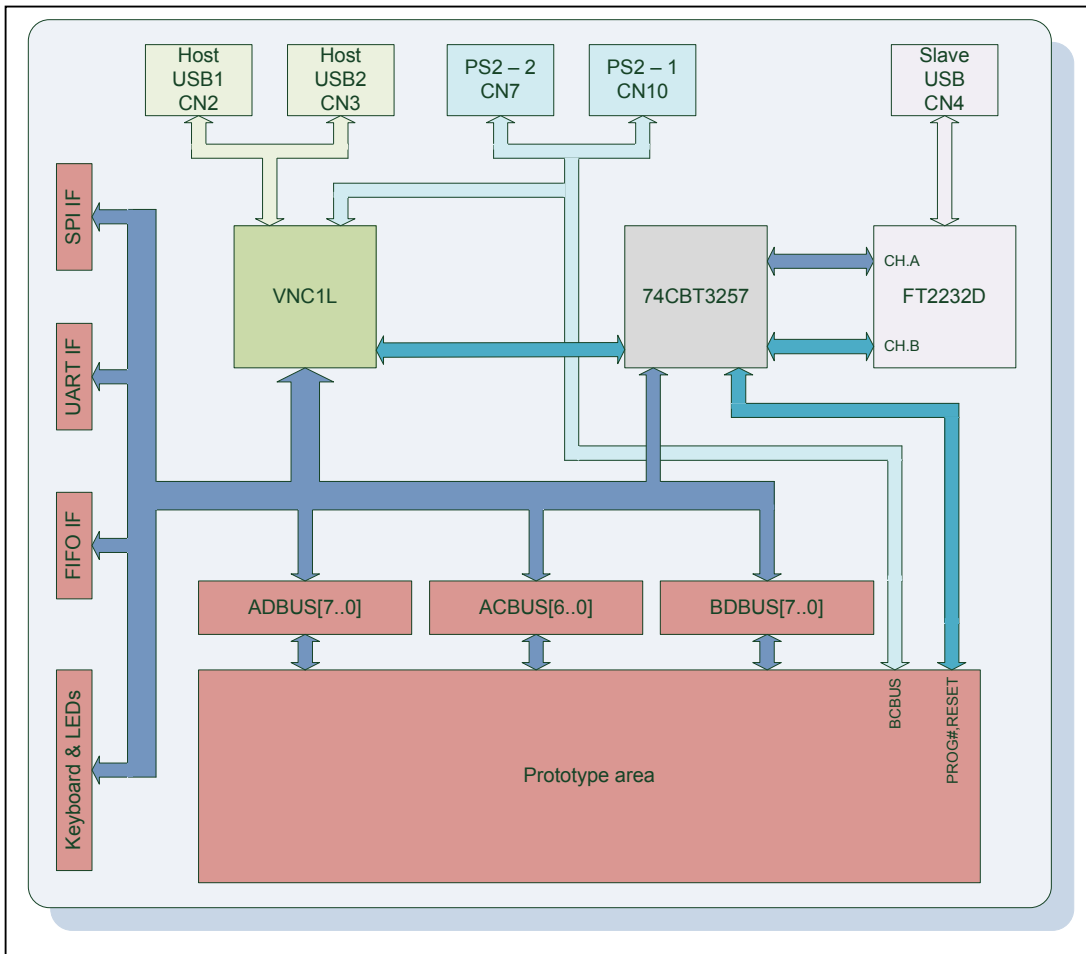

Figure 3-2 V-Eval Board block diagram.

3.2 Functional Block Description.

3.2.1 Components.

Component	Board designator	Description
VNC1L IC	U2	VNC1L Embedded USB Host device
USB-UART bridge	U3	FT2232D Dual USB ⇔ UART/FIFO device
Configuration memory	U4	9346 Serial SPI EEPROM for FT2232 configuration data
UART multiplexer	U5	74CBT3257 4-bit, 1to2, FET Multiplexer/Demultiplexer
3.3V regulator	U1	AIC1735-33 Ultra low dropout 3.3V voltage regulator
12MHz crystal	Y1	12MHz crystal for VNC1-L
6MHz crystal	Y2	6MHz crystal for FT2232D
Single 5V DC power supply	CN1	Board adapter for included 5V DC power supply
Power switch	SW1	Power On/Off switch
Power source select	JP9	Power source selection jumper.
Reset button	SW2	Push-button switch for manual reset of VNC1L device
Keyboard	SW3-SW7	Five user push-button switches
User LEDs	LED6-LED10	Five green user LEDs
Power LED	LED1	Green LED
A_RX LED	LED3	Green LED
A_TX LED	LED4	Yellow LED
B_RX LED	LED5	Green LED
PROG LED	LED2	Red LED
LEDs enable jumpers	JP10-JP14	Enable/disable user-defined LEDs
MODE-0 and MODE-1 jumpers ⁽¹⁾	JP1, JP2	Monitor interface select jumpers
PS2 jumpers	JP4-JP7	PS2 interface enable jumpers.
REMOTE WAKEUP	JP3	VNC1L remote wakeup jumper
VBUS jumpers	JP15, JP16	USB1, USB2 power bus enable jumpers
USB terminal ON/OFF	JP8	USB terminal enable/disable jumper
Notes		
(1) refer to table 5-12 for more information about monitor interface configurations.		

Table 3-1 V-Eval Board components.

3.2.2 Interfaces.

Component	Board designator	Description
USB1, USB2 ⁽²⁾	CN2, CN3	VNC1L USB host ports 1&2
PS2-1, PS2-2 ⁽³⁾	CN10, CN7	VNC1L PS2 ports 1&2
SPI ⁽⁴⁾	CN12	VNC1L SPI interface pins
UART ⁽⁴⁾	CN9	VNC1L UART interface pins
FIFO ⁽⁴⁾	CN5	VNC1-L FIFO interface pins
AD[7..0] ⁽⁴⁾	CN6	VNC1L ADBUS IO port pins
AC[6..0] ⁽⁴⁾	CN8	VNC1L ACBUS IO port pins
BD[7..0] ⁽⁴⁾	CN11	VNC1L BDBUS IO port pins
Prototyping area ⁽⁴⁾	-	All of VNC1-L IO ports and PROG#, RESET# pins are brought on to this area
Notes (2) When a VDSC firmware is loaded in to the VNC1L flash memory USB1 (CN2) connector is configured as a slave USB port. You need to use a gender changer supplied to connect this port to USB host port. (3) PS2-1 (CN10) and PS2-2 (CN7) ports are not used in any of current VNC1L's firmware versions. (4) Those pins are shared between different areas and connectors on the board. You can use only one device at time connected to those pins.		

Table 3-2 V-Eval Board interfaces.

4 Testing the board.

Make sure that the Power Select jumper JP9 is in P.S. position (pins 2&3 shorted).

Connect the 5V DC/1A power supply included in V-Eval Kit to the power adapter connector (CN1), connect USB A/B cable to USB B connector (CN4) on V-Eval Board and to a free USB port on host PC. Switch SW1 to the ON position (towards board edge). LED1 – POWER should now be on.

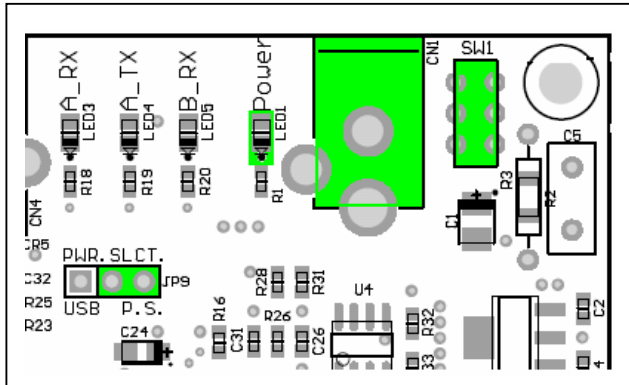

Figure 4-1 Power connector.

All of the board components draw power either directly from this 5V supply or from 3.3V regulator that is powered by this 5V supply.

The V-Eval Board comes with VDAP Disk And Peripheral Firmware version pre-programmed in to the VNC1L program flash memory.

After the power is applied to the board the POWER LED (LED1) illuminating and VNC1L (loaded with default firmware) starting to play 2 seconds LED pattern on user LEDs - LED7 and LED8.

For more information about firmware functionality please refer to the Vinculum web site at <http://www.vinculum.com/documents.html#vfwspecs> in the "Vinculum Firmware Specifications" section.

5 Detailed description of board components.

5.1 Power select jumper JP9.

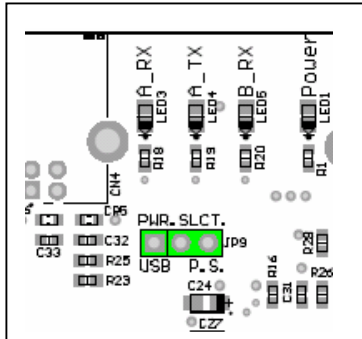

Figure 5-1 Power select jumper.

V-Eval Board can draw its power either from wall 5V/1A DC Power Supply or from USB B type connector (CN4) when connected to the host PC. To enable USB power supply feature, switch the jumper JP9 to USB position, pins 1&2 shorted (pin 1 has a rectangle shape on the bottom side of the board).

Warning!

Please remember that every device connected to the PC through USB port can draw NO MORE than 500mA from host PC 5V power bus.

5.2 ADBUS port connector CN6.

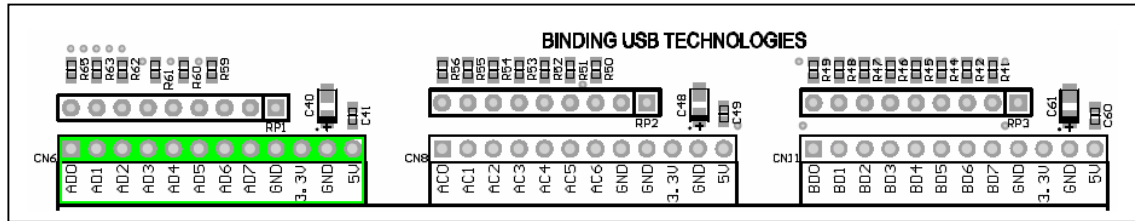

Figure 5-2 ADBUS port connector.

The VNC1L's eight ADBUS pins are brought on to this connector. Additionally there are 5V, 3.3V and GND power pins.

Signal pins are shared between other IO connectors and prototyping area on the board. For more information refer to the V-Eval Board schematics.

Signal name	Connector pin number	VNC1L pin name	VNC1L pin number	IO type	Description
AD0 ⁽⁵⁾	1	ADBUSH0	31	IO	ADBUSH port, data bit0
AD1 ⁽⁵⁾	2	ADBUSH1	32	IO	ADBUSH port, data bit1
AD2 ⁽⁵⁾	3	ADBUSH2	33	IO	ADBUSH port, data bit2
AD3 ⁽⁵⁾	4	ADBUSH3	34	IO	ADBUSH port, data bit3
AD4 ⁽⁵⁾	5	ADBUSH4	35	IO	ADBUSH port, data bit4
AD5 ⁽⁵⁾	6	ADBUSH5	36	IO	ADBUSH port, data bit5
AD6 ⁽⁵⁾	7	ADBUSH6	37	IO	ADBUSH port, data bit6
AD7 ⁽⁵⁾	8	ADBUSH7	38	IO	ADBUSH port, data bit7
3.3V ⁽⁶⁾	9			-	3.3V power rail.
GND	10			-	Ground pin
5V ⁽⁷⁾	11			-	5V power rail.
GND	12			-	Ground pin

Notes:

(5) All VNC1L's IO pins can be driven either from 3.3V LVTTTL or 5V True TTL logic levels. Those pins are shared between different areas and connectors on the board. You can use only one device at time connected to these pins.

(6) This pin is connected to 3.3V regulator output. External device can draw no more than 100mA when board is powered from power supply and no more than 50mA when the board is powered from USB power bus.

(7) This pin is connected to the board's 5V power rail. External device can draw no more than 100mA when board is powered from power supply and no more than 50mA when the board is powered from USB power bus.

Table 5-1 ADBUS port connector CN6.

5.3 ACBUS connector CN8

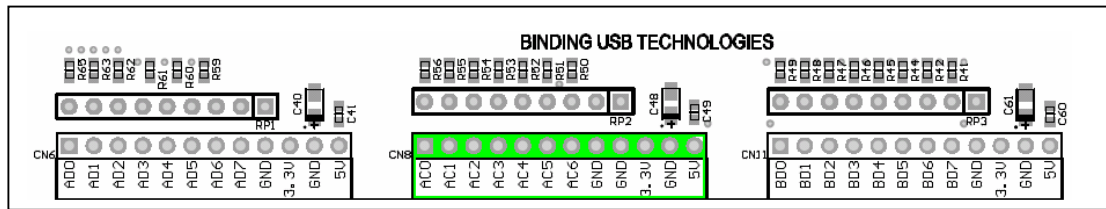

Figure 5-3 ACBUS port connector CN8.

The VNC1L's eight ACBUS pins are brought on to this connector. Additionally there are 5V, 3.3V and GND power pins. Signal pins are shared between other IO connectors and prototyping area on the board. For more information refer to the V-Eval Board schematics.

Signal name	Connector pin number	VNC1L pin name	VNC1L pin number	IO type	Description
AC0 ⁽⁸⁾	1	ACBUS0	41	IO	ACBUS port data bit0
AC1 ⁽⁸⁾	2	ACBUS1	42	IO	ACBUS port data bit1
AC2 ⁽⁸⁾	3	ACBUS2	43	IO	ACBUS port data bit2
AC3 ⁽⁸⁾	4	ACBUS3	44	IO	ACBUS port data bit3
AC4 ⁽⁸⁾	5	ACBUS4	45	IO	ACBUS port data bit4
AC5 ⁽⁸⁾	6	ACBUS5	46	IO	ACBUS port data bit5
AC6 ⁽⁸⁾	7	ACBUS6	47	IO	ACBUS port data bit6
AC7 ⁽⁸⁾	8	ACBUS7	48	IO	ACBUS port data bit7
3.3V ⁽⁹⁾	9			-	3.3V power rail. Can be used to power external devices
GND	10			-	Ground pin
5V ⁽¹⁰⁾	11			-	5V power rail. Can be used to power external devices
GND	12			-	Ground pin
Notes:					
(8)	All VNC1L's IO pins can be driven either from 3.3V LVTTTL or 5V True TTL logic levels. Those pins are shared between different areas and connectors on the board. You can use only one device at time connected to these pins.				
(9)	This pin is connected to 3.3V regulator output. External device can draw no more than 100mA when board is powered from power supply and no more than 50mA when the board is powered from USB power bus.				
(10)	This pin is connected to the board's 5V power rail. External device can draw no more than 100mA when board is powered from power supply and no more than 50mA when the board is powered from USB power bus.				

Table 5-2 ACBUS port connector CN8

5.4 BDBUS port connector CN11.

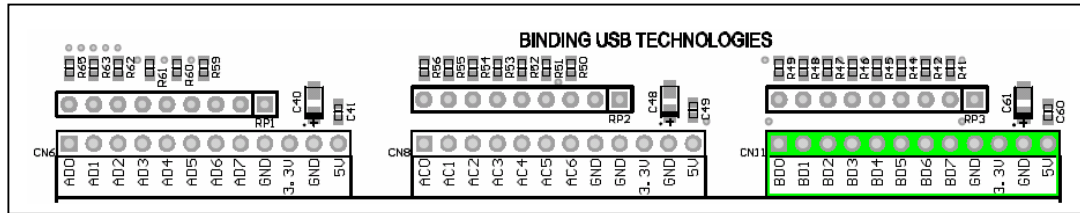

Figure 5-4 BDBUS port connector CN11.

The VNC1L's eight BDBUS pins are brought on to this connector. Additionally there are 5V, 3.3V and GND power pins. Signal pins are shared between other IO connectors and prototyping area on the board. For more information refer to the V-Eval Board schematics.

Signal name	Connector pin number	VCN1L pin name	VCN1L pin number	IO type	Description
BD0 ⁽¹¹⁾	1	BDBUS0	11	IO	BDBUS port data bit0
BD1 ⁽¹¹⁾	2	BDBUS1	12	IO	BDBUS port data bit1
BD2 ⁽¹¹⁾	3	BDBUS2	13	IO	BDBUS port data bit2
BD3 ⁽¹¹⁾	4	BDBUS3	14	IO	BDBUS port data bit3
BD4 ⁽¹¹⁾	5	BDBUS4	15	IO	BDBUS port data bit4
BD5 ⁽¹¹⁾	6	BDBUS5	16	IO	BDBUS port data bit5
BD6 ⁽¹¹⁾	7	BDBUS6	18	IO	BDBUS port data bit6
BD7 ⁽¹¹⁾	8	BDBUS7	19	IO	BDBUS port data bit7
3.3V ⁽¹²⁾	9			-	3.3V power rail. Can be used to power external devices
GND	10			-	Ground pin
5V ⁽¹³⁾	11			-	5V power rail. Can be used to power external devices
GND	12			-	Ground pin

Notes:

- (11) All VNC1L's IO pins can be driven either from 3.3V LVTTTL or 5V True TTL logic levels. Those pins are shared between different areas and connectors on the board. You can use only one device at time connected to these pins.
- (12) This pin is connected to 3.3V regulator output. External device can draw no more than 100mA when board is powered from power supply and no more than 50mA when the board is powered from USB power bus.
- (13) This pin is connected to the board's 5V power rail. External device can draw no more than 100mA when board is powered from power supply and no more than 50mA when the board is powered from USB power bus.

Table 5-3 BDBUS port connector CN11

5.5 UART interface connector CN9.

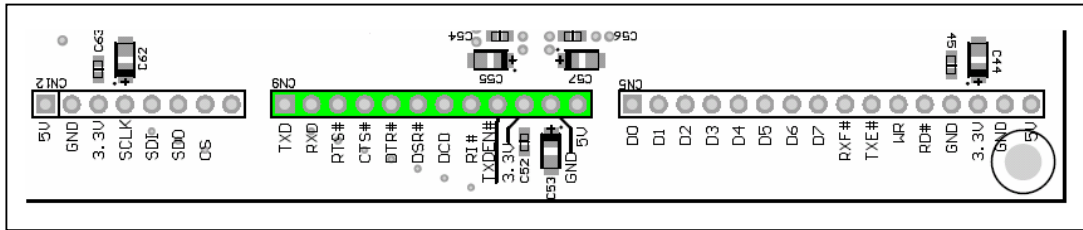

Figure 5-5 UART interface connector CN9.

For easy connection to peripherals all UART pins are brought on to this connector. Additionally there are 5V, 3.3V and GND power pins. Signal pins are shared between other IO connectors and prototyping area on the board. For more information refer to the V-Eval Board schematics.

Signal name	Connector pin number	VCN1L pin name	VCN1L pin number	IO type	Description
TXD ⁽¹⁴⁾	1	ADBUS0	31	O	Transmit data
RXD ⁽¹⁴⁾	2	ADBUS1	32	I	Receive data
RTS# ⁽¹⁴⁾	3	ADBUS2	33	O	Request To Send.
CTS# ⁽¹⁴⁾	4	ADBUS3	34	I	Clear To Send.
DTR# ⁽¹⁴⁾	5	ADBUS4	35	O	Data Terminal Ready.
DSR# ⁽¹⁴⁾	6	ADBUS5	36	I	Data Set Ready.
DCD# ⁽¹⁴⁾	7	ADBUS6	37	I	Data Carrier Detect.
RI# ⁽¹⁴⁾	8	ADBUS7	38	I	Ring Indicator.
TXDEN# ⁽¹⁴⁾	9	ACBUS0	41	O	Transmit Enable.
3.3V ⁽¹⁵⁾	10	-	-	-	3.3V power rail. Can be used to power external devices
GND	11	-	-	-	Ground pin
5V ⁽¹⁶⁾	12	-	-	-	5V power rail. Can be used to power external devices

Notes:

- (14) All VNC1L's IO pins can be driven either from 3.3V LVTTTL or 5V True TTL logic levels. Those pins are shared between different areas and connectors on the board. You can use only one device at time connected to these pins.
- (15) This pin is connected to 3.3V regulator output. External device can draw no more than 100mA when board is powered from power supply and no more than 50mA when the board is powered from USB power bus.
- (16) This pin is connected to the board's 5V power rail. External device can draw no more than 100mA when board is powered from power supply and no more than 50mA when the board is powered from USB power bus.

Table 5-4 UART interface connector CN9

5.6 SPI interface connector CN12.

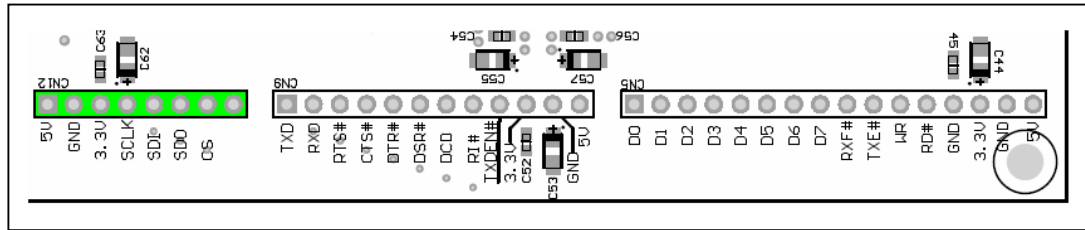

Figure 5-6 SPI interface connector CN12.

For easy connection to peripherals all Serial Peripheral Interface (SPI) pins are brought on to this connector. Additionally there are 5V, 3.3V and GND power pins. Signal pins are shared between other IO connectors and prototyping area on the board. For more information refer to the V-Eval Board schematics.

Signal name	Connector pin number	VNC1L pin name	VNC1L pin number	IO type	Description
3.3V ⁽¹⁸⁾	1			-	3.3V power rail. Can be used to power external devices
GND	2			-	Ground pin
5V ⁽¹⁹⁾	3			-	5V power rail. Can be used to power external devices
SCLK ⁽¹⁷⁾	4	ADBUS0	31	O	SPI interface Clock signal.
SDI ⁽¹⁷⁾	5	ADBUS1	32	I	SPI interface Data In signal.
SDO ⁽¹⁷⁾	6	ADBUS2	33	O	SPI interface Data Out signal.
CS ⁽¹⁷⁾	7	ADBUS3	34	O	SPI interface Chip Select signal.
GND	8			-	Ground pin
Notes:					
(17) All VNC1L's IO pins can be driven either from 3.3V LVTTTL or 5V True TTL logic levels. Those pins are shared between different areas and connectors on the board. You can use only one device at time connected to these pins.					
(18) This pin is connected to 3.3V regulator output. External device can draw no more than 100mA when board is powered from power supply and no more than 50mA when the board is powered from USB power bus.					
(19) This pin is connected to the board's 5V power rail. External device can draw no more than 100mA when board is powered from power supply and no more than 50mA when the board is powered from USB power bus.					

Table 5-5 SPI Interface connector CN12

5.7 FIFO interface connector CN5

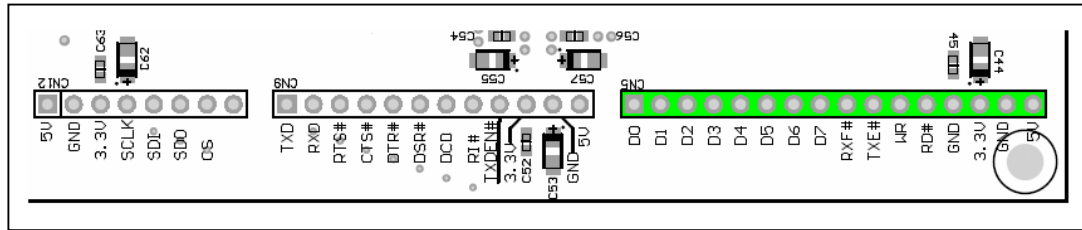

Figure 5-7 FIFO interface connector CN5.

For easy connection to peripherals all FIFO interface pins are brought on to this connector. Additionally there are 5V, 3.3V and GND power pins. Signal pins are shared between other IO connectors and prototyping area on the board. For more information refer to the V-Eval Board schematics.

Signal name	Connector pin number	VNC1L pin name	VNC1L pin number	IO type	Description
D0 ⁽²⁰⁾	1	ADBUS0	31	IO	FIFO interface Data Bit0.
D1 ⁽²⁰⁾	2	ADBUS1	32	IO	FIFO interface Data Bit1.
D2 ⁽²⁰⁾	3	ADBUS2	33	IO	FIFO interface Data Bit2.
D3 ⁽²⁰⁾	4	ADBUS3	34	IO	FIFO interface Data Bit3.
D4 ⁽²⁰⁾	5	ADBUS4	35	IO	FIFO interface Data Bit4.
D5 ⁽²⁰⁾	6	ADBUS5	36	IO	FIFO interface Data Bit5.
D6 ⁽²⁰⁾	7	ADBUS6	37	IO	FIFO interface Data Bit6.
D7 ⁽²⁰⁾	8	ADBUS7	38	IO	FIFO interface Data Bit7.
RXF# ⁽²⁰⁾	9	ACBUS0	41	O	FIFO interface control line. When low data is available to read on D[7..0] pins
TXE# ⁽²⁰⁾	10	ACBUS1	42	O	FIFO interface control line. When low data can be written to the D[7..0] pins
WR ⁽²⁰⁾	11	ACBUS2	43	I	Write latch signal. Active high
RD# ⁽²⁰⁾	12	ACBUS3	44	I	Read latch signal. Active low
3.3V ⁽²¹⁾	13	-	-	-	3.3V power rail. Can be used to power external devices
GND	14	-	-	-	Ground pin
5V ⁽²²⁾	15	-	-	-	5V power rail. Can be used to power external devices
Notes:					
(20) All VNC1L's IO pins can be driven either from 3.3V LVTTTL or 5V True TTL logic levels. Those pins are shared between different areas and connectors on the board. You can use only one device at time connected to these pins.					
(21) This pin is connected to 3.3V regulator output. External device can draw no more than 100mA when board is powered from power supply and no more than 50mA when the board is powered from USB power bus.					
(22) This pin is connected to the board's 5V power rail. External device can draw no more than 100mA when board is powered from power supply and no more than 50mA when the board is powered from USB power bus.					

Table 5-6 FIFO Interface connector CN5

5.8 Prototyping area

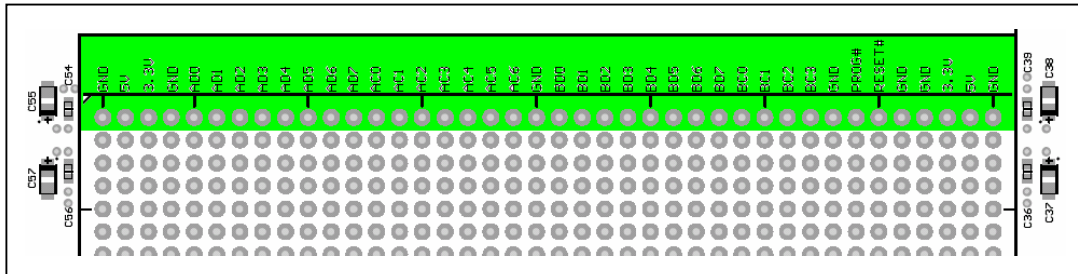

Figure 5-8 Prototyping area.

A prototype area consisting of an array of 800 0.1-inch pitch holes is provided. This area can be used to add custom components to the V-Eval Board. Connections to the 5V, 3.3 V planes and ground plane of the V-Eval Board are included. The silk-screen text on the board indicates which holes are connected to which planes. Only top-most row is connected to VNC1L IO ports, power and ground planes. All the other holes are not connected to anything on the board. Signal pins are shared between other IO connectors on the board. For more information refer to the V-Eval Board schematics.

Signal name	Connector pin number	VNC1L pin name	VNC1L pin number	IO type	Description
GND	1	-	-	-	Ground pin
5V ⁽²⁵⁾	2	-	-	-	5V power rail. Can be used to power external devices
3.3V ⁽²⁴⁾	3	-	-	-	3.3V power rail. Can be used to power external devices
GND	4	-	-	-	Ground pin
AD0	5	ADBUS0	31	IO	ADBUS port Data Bit0.
AD1	6	ADBUS1	32	IO	ADBUS port Data Bit1.
AD2	7	ADBUS2	33	IO	ADBUS port Data Bit2.
AD3	8	ADBUS3	34	IO	ADBUS port Data Bit3.
AD4	9	ADBUS4	35	IO	ADBUS port Data Bit4.
AD5	10	ADBUS5	36	IO	ADBUS port Data Bit5.
AD6	11	ADBUS6	37	IO	ADBUS port Data Bit6.
AD7	12	ADBUS7	38	IO	ADBUS port Data Bit7.
AC0	13	ACBUS0	41	IO	ACBUS port Data Bit0.
AC1	14	ACBUS1	42	IO	ACBUS port Data Bit1.
AC2	15	ACBUS2	43	IO	ACBUS port Data Bit2.
AC3	16	ACBUS3	44	IO	ACBUS port Data Bit3.
AC4	17	ACBUS4	45	IO	ACBUS port Data Bit4.
AC5 ⁽²³⁾	18	ACBUS5	46	IO	ACBUS port Data Bit5/MODE0.
AC6 ⁽²³⁾	19	ACBUS6	47	IO	ACBUS port Data Bit6/MODE1.
GND	20	-	-	-	Ground pin
BD0	21	BDBUS0	11	IO	BDBUS port Data Bit0.
BD1	22	BDBUS1	12	IO	BDBUS port Data Bit1.
BD2	23	BDBUS2	13	IO	BDBUS port Data Bit2.
BD3	24	BDBUS3	14	IO	BDBUS port Data Bit3.
BD4	25	BDBUS4	15	IO	BDBUS port Data Bit4.
BD5	26	BDBUS5	16	IO	BDBUS port Data Bit5.

BD6	27	BDBUS6	18	IO	BDBUS port Data Bit6.
BD7	28	BDBUS7	19	IO	BDBUS port Data Bit7.
BC0	29	BCBUS0	20	IO	BCBUS port Data Bit0.
BC1	30	BCBUS1	21	IO	BCBUS port Data Bit1.
BC2	31	BCBUS2	22	IO	BCBUS port Data Bit2.
BC3	32	BCBUS3	23	IO	BCBUS port Data Bit3.
GND	33	-	-	-	Ground pin
PROG#	34	PROG#	10	I	VNC1L PROG# pin
RESET#	35	RESET#	9	I	VNC1L RESET# pin
GND	36	-	-	-	Ground pin
GND	37	-	-	-	Ground pin
3.3V ⁽²⁴⁾	38	-	-	-	3.3V power rail. Can be used to power external devices
5V ⁽²⁵⁾	39	-	-	-	5V power rail. Can be used to power external devices
GND	40	-	-	-	Ground pin
Notes:					
(23) Refer to table xx for more information about firmware functionality of these pins.					
(24) This pin is connected to 3.3V regulator output. External device can draw no more than 100mA when board is powered from power supply and no more than 50mA when the board is powered from USB power bus.					
(25) This pin is connected to the board's 5V power rail. External device can draw no more than 100mA when board is powered from power supply and no more than 50mA when the board is powered from USB power bus.					

Table 5-7 Prototyping area

5.9 USB1 interface CN2

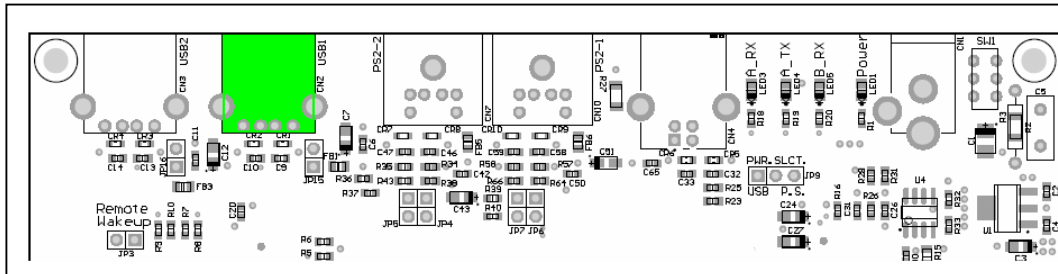

Figure 5-9 USB1 interface CN2.

VNC1L USB1 transceiver pins are brought on this connector. Depending of firmware version this port can be configured as host or slave port.

Signal name	Connector pin number	VNC1L pin name	VNC1L pin number	IO type	Description
5V ⁽²⁶⁾	1	-		-	5V power rail. Can be used to power external devices
USB1-DM	2	USB1 DM	26	IO	USB1 transceiver, data line Minus
USB1-DP	3	USB1 DP	25	IO	USB1 transceiver, data line Plus
GND	4	-		-	Ground pin
Shield	5, 6	-		-	Connector shield. Connected to ground.

Notes:

(26) This pin is connected to the board's 5V power rail. External device can draw no more than 100mA when board is powered from power supply and no more than 50mA when the board is powered from USB power bus.

Table 5-8 USB1 host/slave connector. CN2

5.10 USB2 interface CN3.

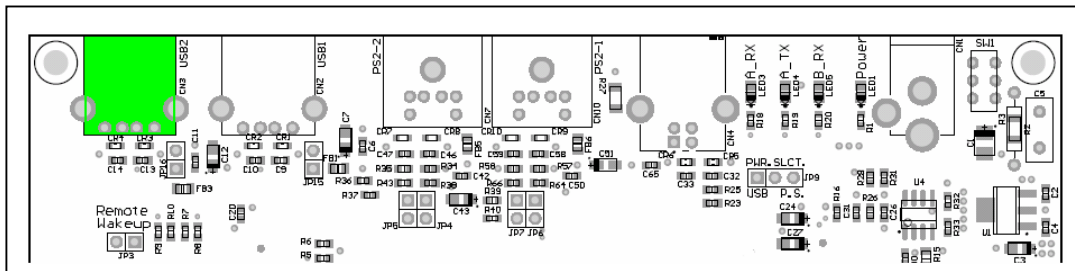

Figure 5-10 USB2 interface CN3.

VNC1L USB2 transceiver pins are brought on this connector. Depending of firmware version this port can be configured as host or slave port.

Signal name	Connector pin number	VNC1L pin name	VNC1L pin number	IO type	Description
5V ⁽²⁷⁾	1	-		-	5V power rail. Can be used to power external devices
USB1-DM	2	USB1 DM	29	IO	USB2 transceiver, data line Minus
USB1-DP	3	USB1 DP	28	IO	USB2 transceiver, data line Plus
GND	4	-		-	Ground pin
Shield	5, 6	-		-	Connector shield. Connected to ground.

Notes:

(27) This pin is connected to the board's 5V power rail. External device can draw no more than 100mA when board is powered from power supply and no more than 50mA when the board is powered from USB power bus.

Table 5-9 USB2 host/slave connector. CN3

5.11 PS2-1 interface. CN10.

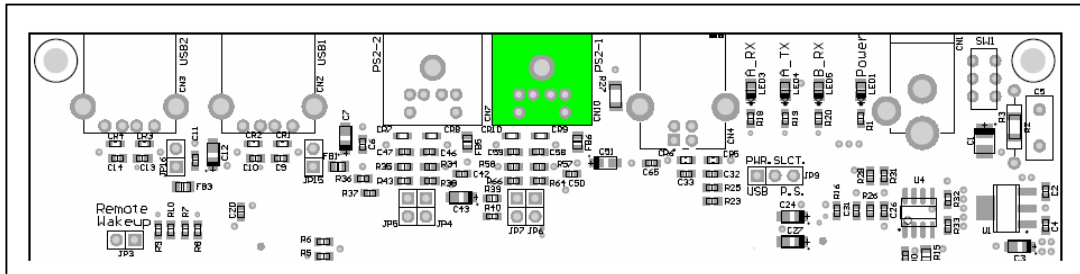

Figure 5-11 PS2 - 1 interface CN10.

VNC1L has a two PS2 interfaces. PS2 – 1 interface pins are brought on this connector. PS2 Keyboard or Mouse can be connected to this connector. Currently PS2 ports are not implemented in any of current firmware versions.

Signal name	Connector pin number	VCN1L pin name	VCN1L pin number	IO type	Description
PS2-1 CLK	5	BCBUS0	20	O	PS2 interface 1 clock signal.
PS2-1 DATA	1	BCBUS1	21	IO	PS2 interface 1 data signal
5V ⁽²⁸⁾	4	-	-	-	5V power rail. Can be used to power external devices
GND	3	-	-	-	Ground pin
NC	2	-	-	-	Not Connected
NC	6	-	-	-	Not Connected
Shield	7	-	-	-	Connector shield. Connected to ground.
Notes:					
(28) This pin is connected to the board's 5V power rail. External device can draw no more than 100mA when board is powered from power supply and no more than 50mA when the board is powered from USB power bus.					

Table 5-10 PS2-1 connector. CN10

5.12 PS2-2 interface. CN7.

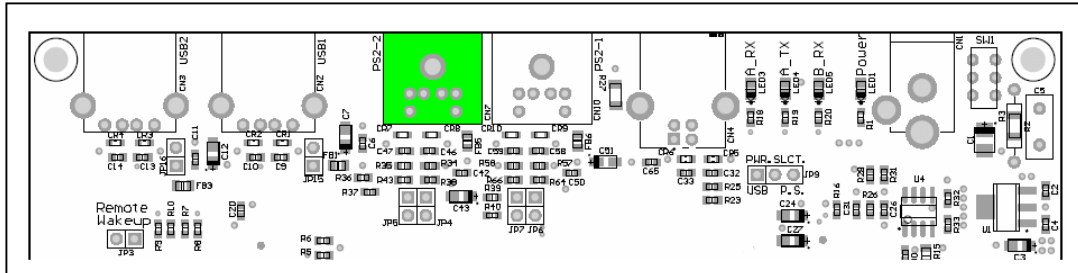

Figure 5-12 PS2 - 2 interface CN7.

VNC1L has a two PS2 interfaces. PS2 – 2 interface pins are brought on this connector. PS2 Keyboard or Mouse can be connected to this connector. Currently PS2 ports are not implemented in any of current firmware versions.

Signal name	Connector pin number	VNC1L pin name	VNC1L pin number	IO type	Description
PS2-2 CLK	5	BCBUS2	22	O	PS2 interface 2 clock signal.
PS2-2 DATA	1	BCBUS3	23	IO	PS2 interface 2 data signal
5V ⁽²⁹⁾	4	-	-	-	5V power rail. Can be used to power external devices
GND	3	-	-	-	Ground pin
NC	2	-	-	-	Not Connected
NC	6	-	-	-	Not Connected
Shield	7	-	-	-	Connector shield. Connected to ground.
Notes:					
(29) This pin is connected to the board's 5V power rail. External device can draw no more than 100mA when board is powered from power supply and no more than 50mA when the board is powered from USB power bus.					

Table 5-11 PS2 - 2 connector. CN7

5.13 Monitor port mode select jumpers JP1, JP2

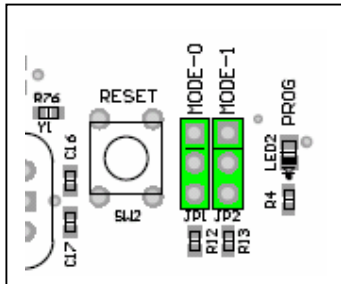

Figure 5-13 Monitor mode select jumpers JP1, JP2.

Those jumpers provide an interface type selection for VNC1L command monitor.
For more information about command monitor port modes please refer to VNC1L Firmware manual at <http://www.vinculum.com/documents.html#vfwspecs>

JP1		JP2		Interface type
Pin 1,2 ⁽³⁰⁾	Pin3,4	Pin 1,2 ⁽³⁰⁾	Pin 3,4	
SHORTED	OPENED	SHORTED	OPENED	UART ⁽³¹⁾
SHORTED	OPENED	OPENED	SHORTED	FIFO ⁽³¹⁾
OPENED	SHORTED	SHORTED	OPENED	SPI ⁽³¹⁾
OPENED	SHORTED	OPENED	SHORTED	UART ⁽³¹⁾

Notes:
 (30) Pin No.1 has a rectangle shape on the bottom side of the board.
 (31) For more detailed information about interface modes please refer to the VNC1L data sheet.

Table 5-12 Monitor interface type selection jumpers JP1, JP2

5.14 User LEDs. LED6 – LED10.

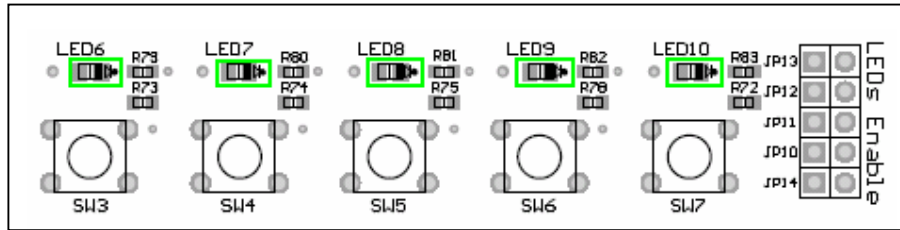

Figure 5-14 User LEDs.

Five green LEDs is provided on board. LED7 & LED8 are controlled by default firmware. LED6, LED9, LED10 can be driven by using IOW (IO Write) command.

For more information about IOW command please refer to VNC1L Firmware manual at <http://www.vinculum.com/documents.html#vfwspecs>

Designator	VCN1L pin name	VCN1L pin number
LED6	BDBUS4	
LED7	BDBUS5	
LED8	BDBUS6	
LED9	BDBUS7	
LED10	ACBUS5	

Table 5-13 User LEDs connections.

5.15 LED enable/disable jumpers JP10 – JP14.

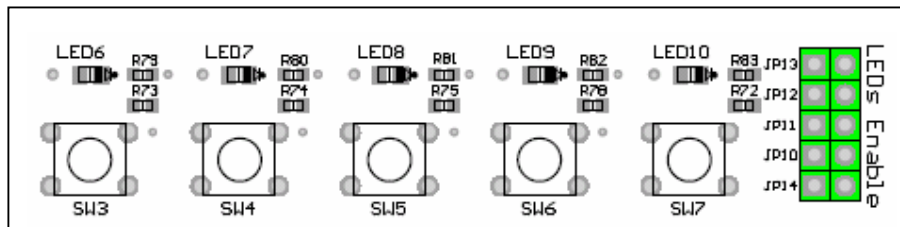

Figure 5-15 LED Enable/Disable jumpers.

Every user-defined LED have an enable/disable jumper. When jumper is closed LED will be illuminate when driven low by one of the VCN1L pins. When jumper is opened LED is disconnected from the VCN1L pin.

Designator	LED affected
JP10	LED6
JP11	LED7
JP12	LED8
JP13	LED9
JP14	LED10

Table 5-14 LED Enable/Disable jumpers.

5.16 User push button switches

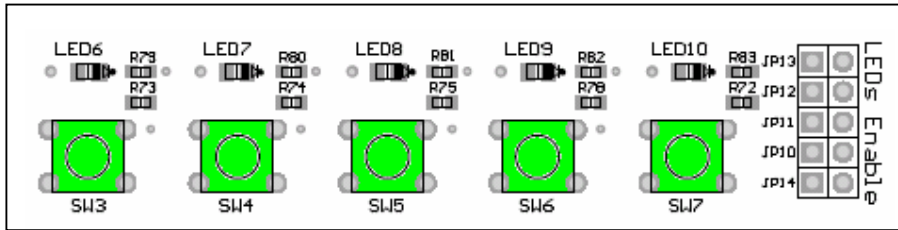

Figure 5-16 User push button switches.

Push – button switches connected straight to VNC1L pins. When switch is pressed down, logic LOW appears on VNC1L's corresponding pin.

The state of the SW3 – SW7 can be read by using IOR (IO Read) command.

For more information about IOR command please refer to VNC1L Firmware manual at <http://www.vinculum.com/documents.html#vfwspecs>

Designator	VNC1L pin name	VNC1L pin number
SW3	BDBUS0	11
SW4	BDBUS1	12
SW5	BDBUS2	13
SW6	BDBUS3	14
SW7	ACBUS6	47

Table 5-15 User Switches

5.17 Host USB power jumpers JP15, JP16.

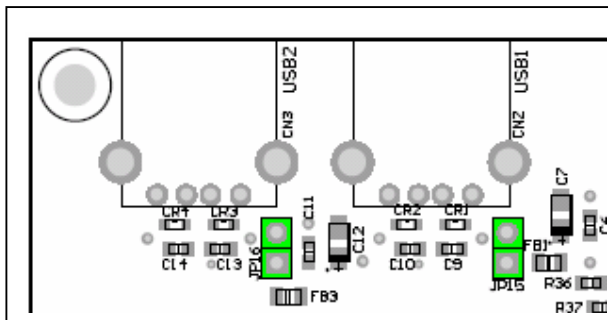

Figure 5-17 USB power enable jumpers.

When either USB1 and/or USB2 ports are used as a host ports, the jumpers JP15 and/or JP16 accordingly should be closed to allow peripheral devices to draw power from board's +5V power rail.

Warning!

When you intended to use these ports as a USB slave ports you need to remove shunts from jumpers JP15, JP16. Failed to do so can cause damage either to the computer or to the V-Eval Board.

5.18 PS2-1, PS2-2 Enable jumpers JP4, JP5, JP5, JP6.

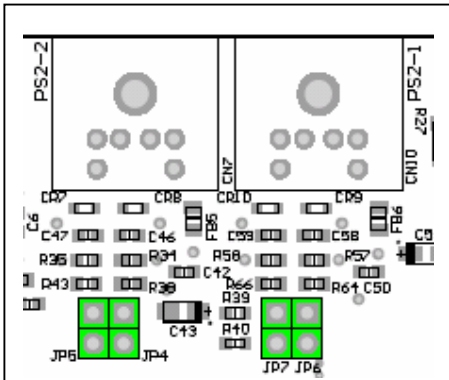

Figure 5-18 USB power enable jumpers.

These jumpers are provided to connect/disconnect PS2 ports from VNC1L device. Currently PS2 ports are not used in any firmware versions. Make sure that JP4, JP5, JP6 and JP7 are left opened.

Designator	Signal name	VNC1L pin
JP4	PS2-2 Data	BCBUS3
JP5	PS2-2 Clk	BCBUS2
JP6	PS2-1 Data	BCBUS1
JP7	PS2-1 Clk	BCBUS0

Table 5-16 PS2 enable jumpers

5.19 Remote Wakeup jumper JP3.

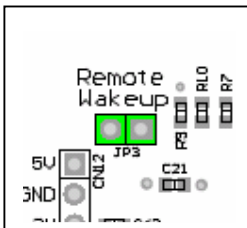

Figure 5-19 Remote Wakeup jumper.

Some versions of firmware are putting VNC1L device in to the Suspend Monitor (SUM) mode when it is idle to reduce the power consumption. To wakeup VNC1L every time data is arrived on its RXD pin JP3 jumper is provided to connect together RXD and RI# pins. When RI# pin is driven low, VNC1L will resume from the SUM mode immediately. To enable remote wakeup feature place shunt on jumper JP3.

5.20 Reset Push-button Switch

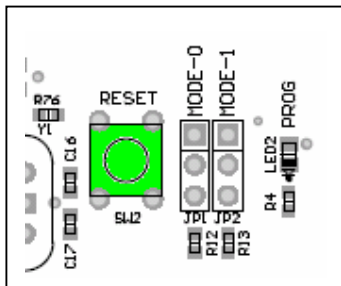

Figure 5-20 Reset Switch

To manually reset VNC1L device a 'RESET' Push-button switch SW2 is provided.

5.21 'PROG' LED

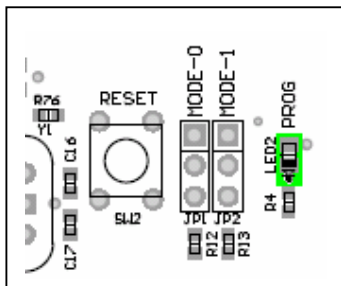

Figure 5-21 LED 'PROG'

This red LED is provided to indicate that VNC1L is in Flash programming mode.

6 Connecting to host PC

Connect USB A/B cable to board's CN4 USB connector.
Connect the other end of cable to a free USB connector on your computer.
Power up the board. The new hardware will be detected and Found New Hardware Wizard will run.

6.1 Drivers installation.

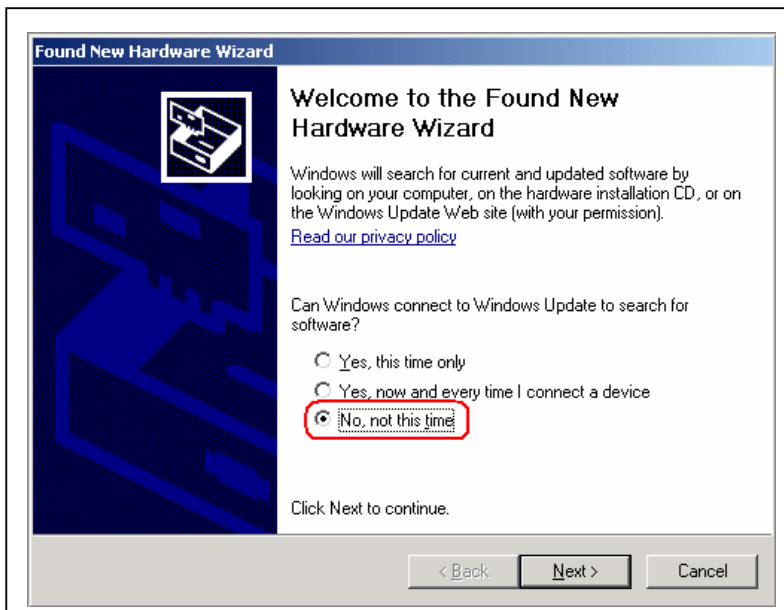

Figure 6-1 Drivers installation

Please select the 'No, not this time' option and click Next button.

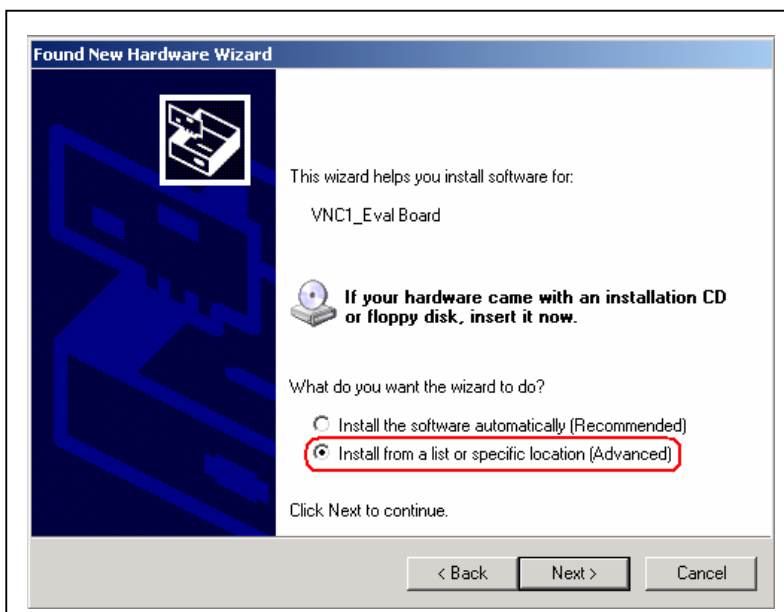

Figure 6-2 Drivers installation

Select 'Install from specific location (Advanced)' option and click 'Next' button.

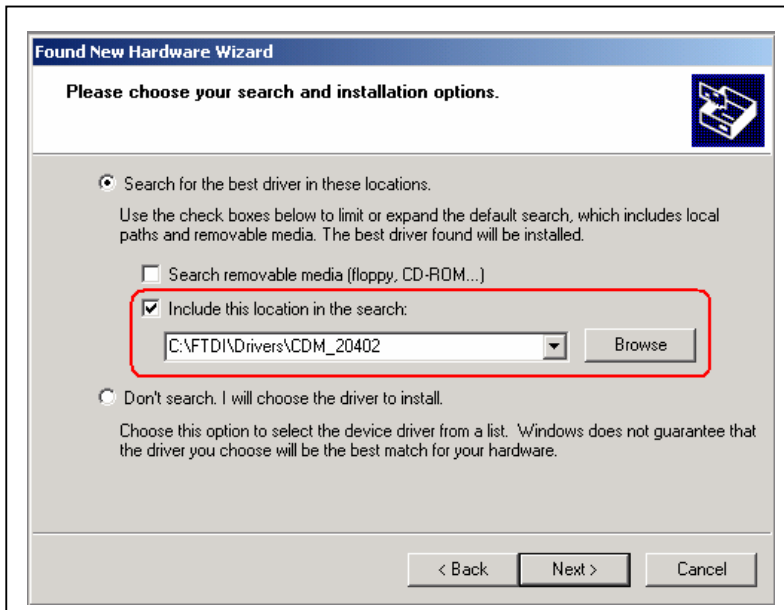

Figure 6-3 Drivers installation

Click 'Browse' button, navigate to drivers directory and click 'Next' button.

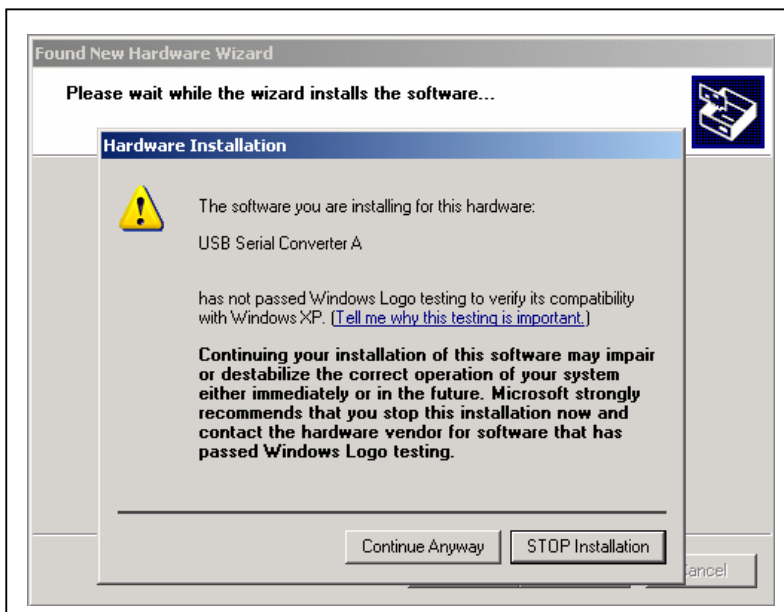

Figure 6-4 Drivers installation

Click 'Continue Anyway' button.

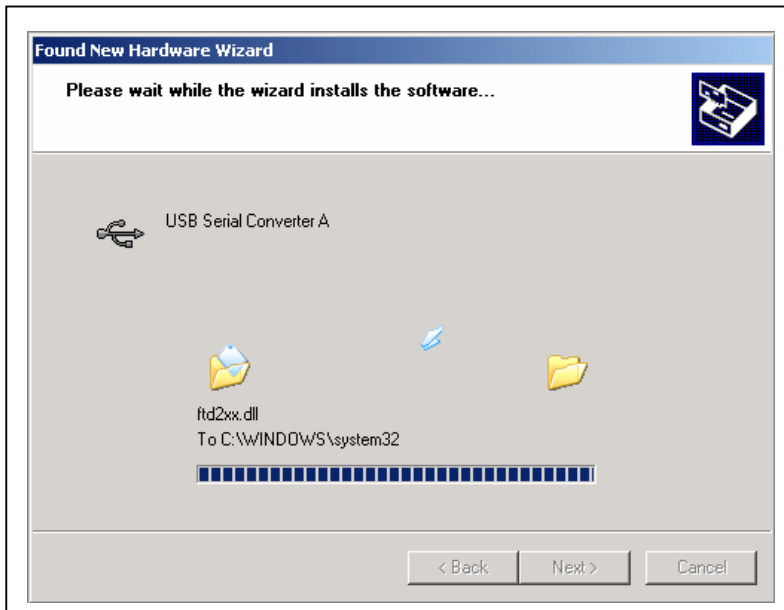

Figure 6-5 Drivers installation

The driver files will now be copied to your system.

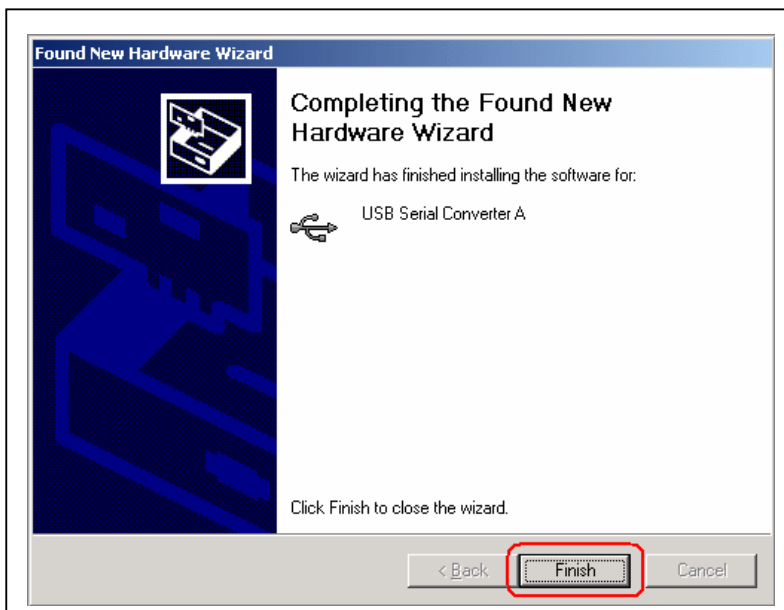

Figure 6-6 Drivers installation

Click 'Finnish' button to complete installation.

The USB device built into the V-Eval Board is a composite USB device. It has two USB Serial Converters and two USB Serial Ports. After you click Finish, a new Found New Hardware Wizard window appears asking to install drivers for another device. This is for the “USB Serial Converter B” part of the composite USB device. Follow the same instructions as above to install the drivers for this device. The Found New Hardware Wizard will appear two times more. This is to install the drivers for the “USB Serial Port”. Again, follow the same instructions above to install the drivers for this device.

For more information about drivers installation please refer to the FTDI's web site at <http://www.ftdichip.com/Drivers/D2XX.htm>

You can find a drivers installation guide is at <http://www.ftdichip.com/Documents/InstallGuides.htm>

7 V-Eval Board Control Panel application.

To demonstrate basic functions of the V-Eval Board the CD-ROM containing Control Panel application is supplied.

Please run program 'VEval.exe'. Form the drop-down list at the top of program window select 'V-Eval-1 Board' port. Click 'Open' button to open communication channel between V-Eval Board and Control Panel application.

Control Panel can work in one of three modes:

7.1 Terminal Mode

This mode works similarly to Hyper Terminal program. Additionally there are few options to control the VNC1L device.

Upper window is for sending commands and data to VNC1L device and displaying responses from it. Every character you type in this window will be immediately sent over USB Serial Port to VNC1L device monitor port. Lower window displays all communication traffic in HEX format.

On right hand side of Control Panel window additional options to control the VNC1L device are provided.

7.1.1 'Options - Mode' tab

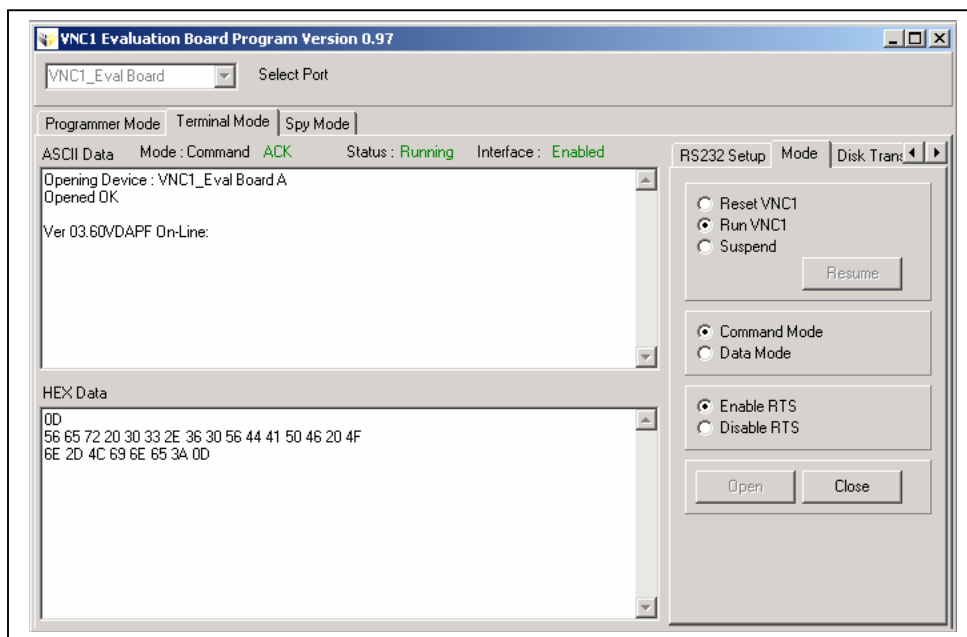

Figure 7-1 Control Panel – Terminal mode

'Reset VNC1' – if you click this option the Control Panel will put VNC1L in reset state by pulling its 'RESET' pin low.

'Run VNC1' – click this option to release VNC1L from reset state by pulling 'RESET' pin high.

'Suspend' – this option will put VNC1L device in suspend state.

'Resume' button – click this button to resume VNC1L device from suspend state.

'Command Mode' – when this option is enabled the VNC1L DSR# pin is pulled high by the Control Panel App. You can send commands to VNC1L monitor port to configure communication parameters or to configure a suitable FTDI device connected to USB1 port on V-Eval Board. Access to Flash Disk connected to USB2 port on V-Eval Board is also allowed.

‘Data Mode’ – if this option is enabled the VNC1L is in data mode. The DSR# pin of VNC1L is pulled low. This mode is provided to send/receive data to/from any device connected to USB1 or USB2 ports on VNC1L EVB. The VNC1L will act like a bridge between device connected to his USB host ports and Control Panel Application. The commands will not be interpreted and executed by VNC1L command monitor.

‘Enable RTS’ – this option enables serial interface of Control Panel. V-Eval Board can send data to Control Panel receive buffer.

‘Disable RTS’ – if this option is checked the V-Eval Board is not allowed to send data to Control Panel App.

7.1.2 Options - ‘RS232 Setup’ tab:

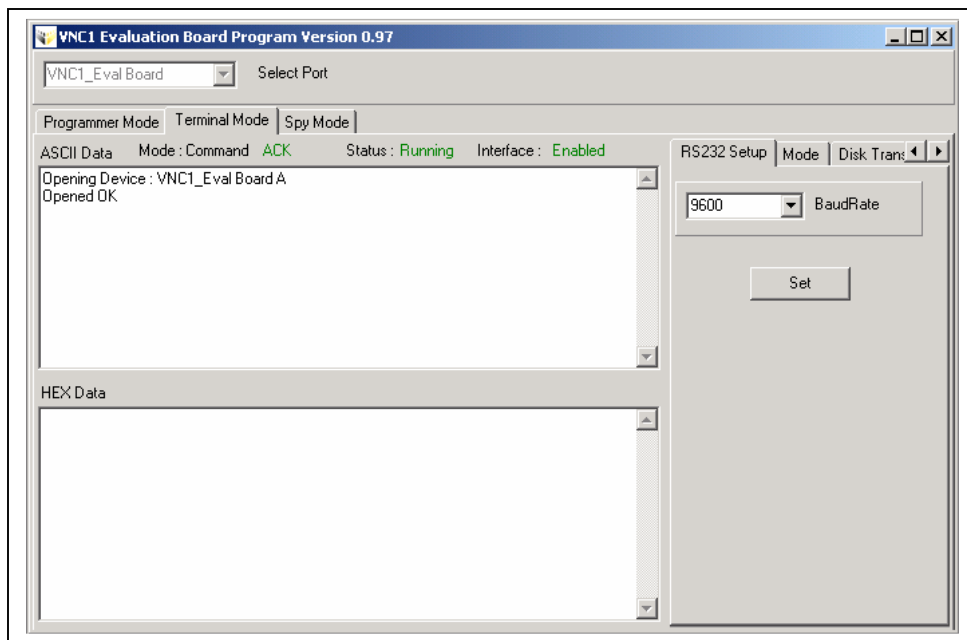

Figure 7-2 Control Panel – Options – RS232 Setup

Here you can change communication interface baudrate. Select desired baurate from ‘BaudRate’ drop-down list and click ‘Set’ button.

7.1.3 Options - 'Disk Transfer' tab

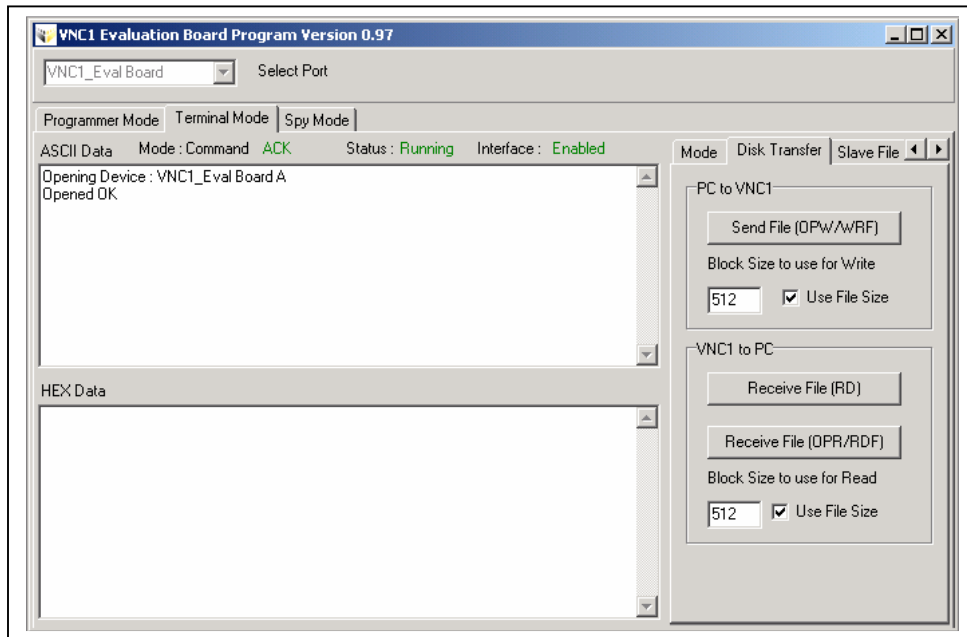

Figure 7-3 Control Panel – Options – Disk Transfer

This tab is provided to demonstrate file transfer between Flash Disk connected to USB2 port on V-Eval Board and Control Panel App.

'Send File (OPW/WRF)' button – click this button to open the Open File dialog window. Navigate to file that you want to send to Flash Disk and click 'OK'. First OPW (Open File For Writing) command is sent to VNC1L device if specified file name is not on Flash Disk, VNC1L device is creating the new file and open it for writing. Then WRF (Write File) command is sent followed by value of 'Block Size to use for Write' edit box or if the 'Use File Size' check box is checked the size of file is sent after the WRF command. After the prompt is received from VNC1L device the file contents are sent to Flash Disk. If 'Use File Size' check box is checked entire file is sent to Flash Disk in one chunk of data.

'Receive File (RD)' button – click this button to specify name of file to read to (file with the same name must be on Flash Disk) click OK. The contents of file specified will be read back to your PC's hard disk.

'Receive File (OPR/RDF)' button – this button works similarly to 'Read File (RD)' except you can specify 'Block Size to use for Read' to read the file in specified pieces of data or check 'Use File Size' to read entire file in one chunk of data.

7.1.4 Options - 'Slave File I/O' tab

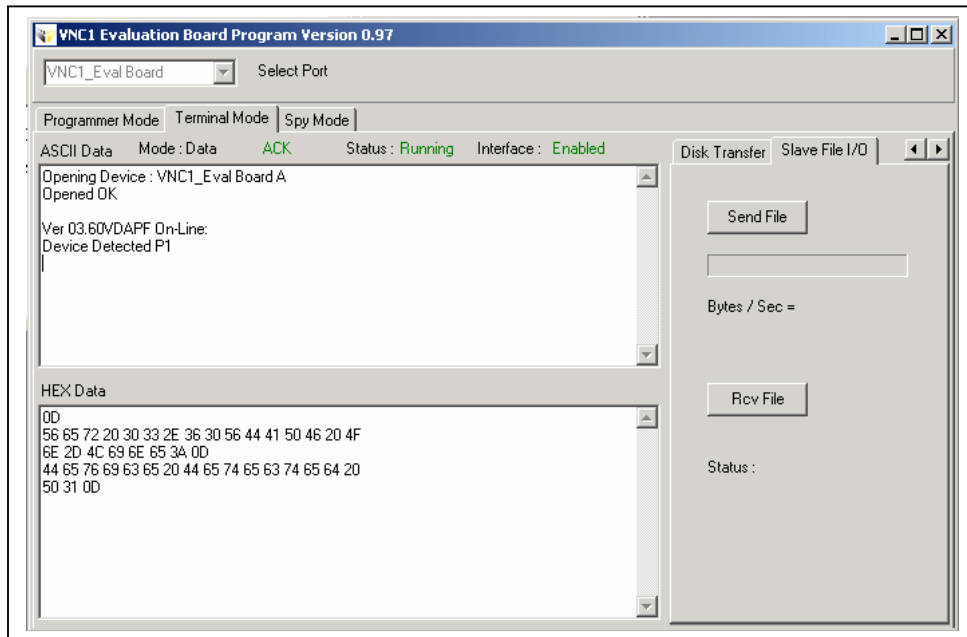

Figure 7-4 Control Panel – Options – Slave File I/O

This tab demonstrates ability to transfer data between an FTDI (FT232, FT245, FT2232) device connected to USB1, USB2 port on V-Eval Board and Control Panel App. Before data transmission is possible you need to Set Current (SC) device and switch VNC1L to data mode.

'Send File' button – click this button, navigate to file you want to sent and click OK. File will be sent to FT2xx slave device on USB1 port of V-Eval Board.

'Rcv File' button – click this button to open the Open File dialog and set the name of file you want to receive, Click OK. All data received from FT2xx device connected to USB1 or USB2 port on V-Eval Board will be saved on your PC's hard disk. After the file has been received please click 'Close File' button.

7.2 Spy Mode

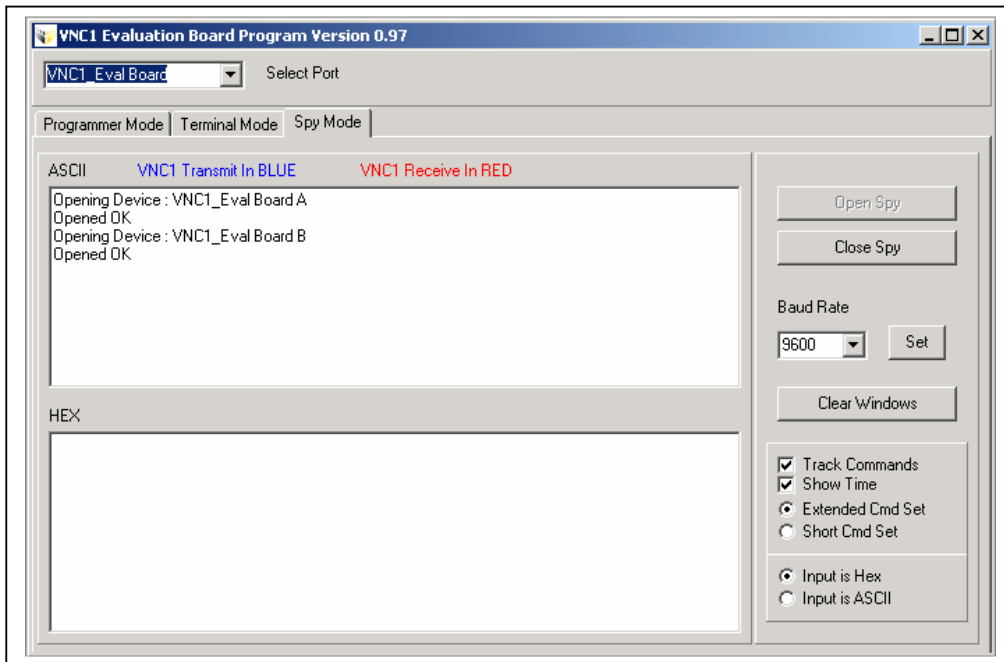

Figure 7-5 Control Panel – Spy Mode

This mode is intended to track all communication between V-Eval Board and other serial device (e.g. Microcontroller) connected to V-Eval Board.

To open spy select desired baudrate from drop-down list and click 'Set' button, then click 'Open Spy' button. You can change the baudrate when spy is already opened. Simply select new baurate and click 'Set' button.

Upper window displays data in ASCII format. All data received by VNC1L device is displayed in red colour and all data transmitted by VNC1L device is displayed in blue colour.

Lower window displays data in HEX format for debug purposes. Like in ASCII window all data received by VNC1L device is displayed in red and all data transmitted by VNC1L is displayed in blue.

If 'Track Commands' check box is checked all decoded commands and answers will be displayed in green colour.

You need to setup the 'Extended Cmd Set' or 'Short Cmd Set' and 'Input is Hex' or 'Input is ASCII' to spy to work properly, according to V-Eval Board communication parameters.

7.3 Programming Mode

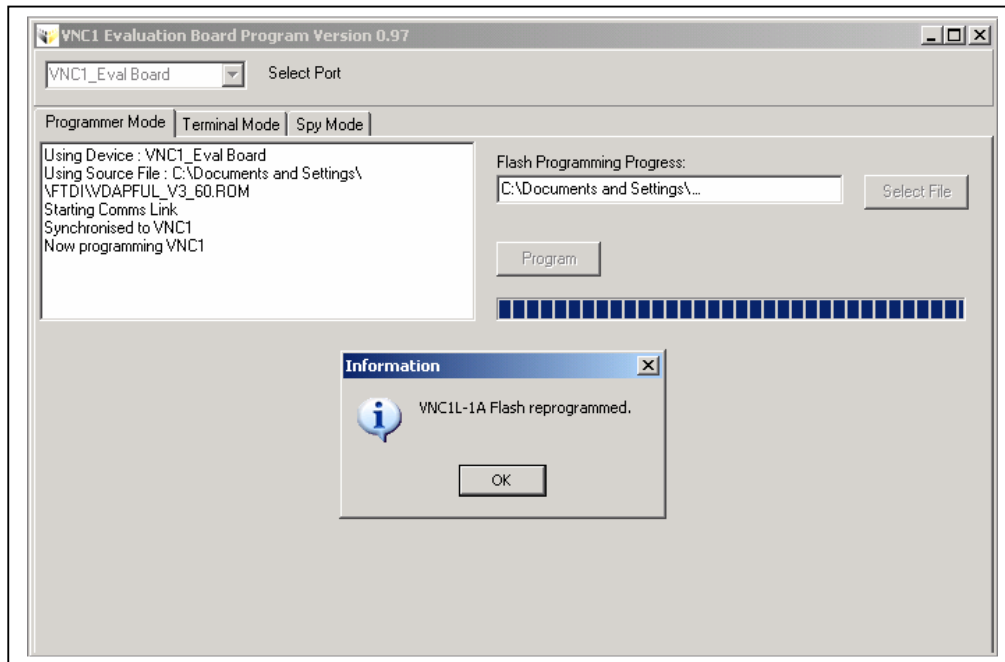

Figure 7-6 Control Panel – Programming Mode

You can reprogram VNC1L device's Flash Program Memory using this mode. The interface is very straight forward, and all reprogramming process is done automatically. Simply click 'Select File' button, navigate to VNC1L's ROM file and then click 'Program' button.

8 V-Eval Board Schematics.

The V-Eval Board schematics can be found at the end of this document.

9 Contact Information

Head Office - Glasgow, UK

Future Technology Devices International Limited
373 Scotland Street
Glasgow G5 8QB
United Kingdom
Tel: +44 (0) 141 429 2777
Fax: +44 (0) 141 429 2758
E-Mail (Sales): vinculum.sales@ftdichip.com
E-Mail (Support): vinculum.support@ftdichip.com
E-Mail (General Enquiries): admin1@ftdichip.com
Web Site URL: <http://www.vinculum.com>
Web Shop URL: <http://apple.clickandbuild.com/cnb/shop/ftdichip>

Branch Office - Taiwan

Future Technology Devices International Limited (Taiwan)
4F, No 16-1, Sec. 6 Mincyuan East Road
Neihu District
Taipei 114
Taiwan, R.O.C.
Tel: +886 2 8791 3570
Fax: +886 2 8791 3576
E-Mail (Sales): tw.sales1@ftdichip.com
E-Mail (Support): tw.support1@ftdichip.com
E-Mail (General Enquiries): tw.admin1@ftdichip.com
Web Site URL: <http://www.vinculum.com>

Branch Office - Hillsboro, Oregon, USA

Future Technology Devices International Limited (USA)
7235 NW Evergreen Parkway, Suite 600
Hillsboro, OR 97124-5803
USA
Tel: +1 (503) 547-0988
Fax: +1 (503) 547-0987
E-Mail (Sales): us.sales@ftdichip.com
E-Mail (Support): us.support@ftdichip.com
E-Mail (General Enquiries): us.admin@ftdichip.com
Web Site URL: <http://www.vinculum.com>

Distributors and Sales Representatives

Please visit the Sales Network page of the FTDI Web site for the contact details of our distributor(s) in your country.

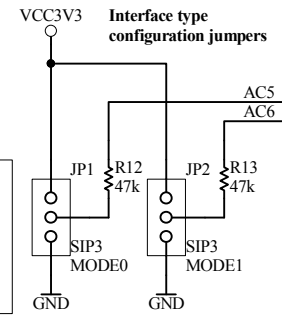
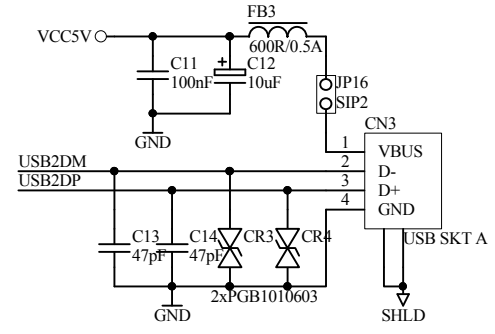
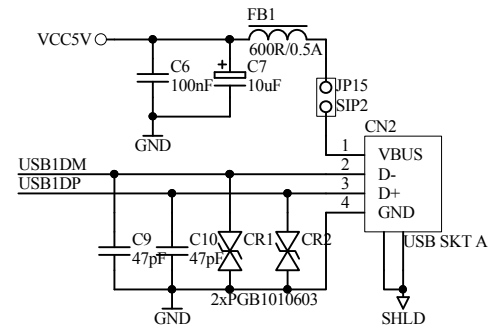
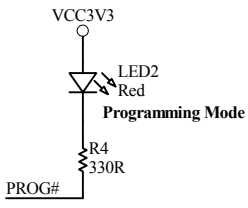
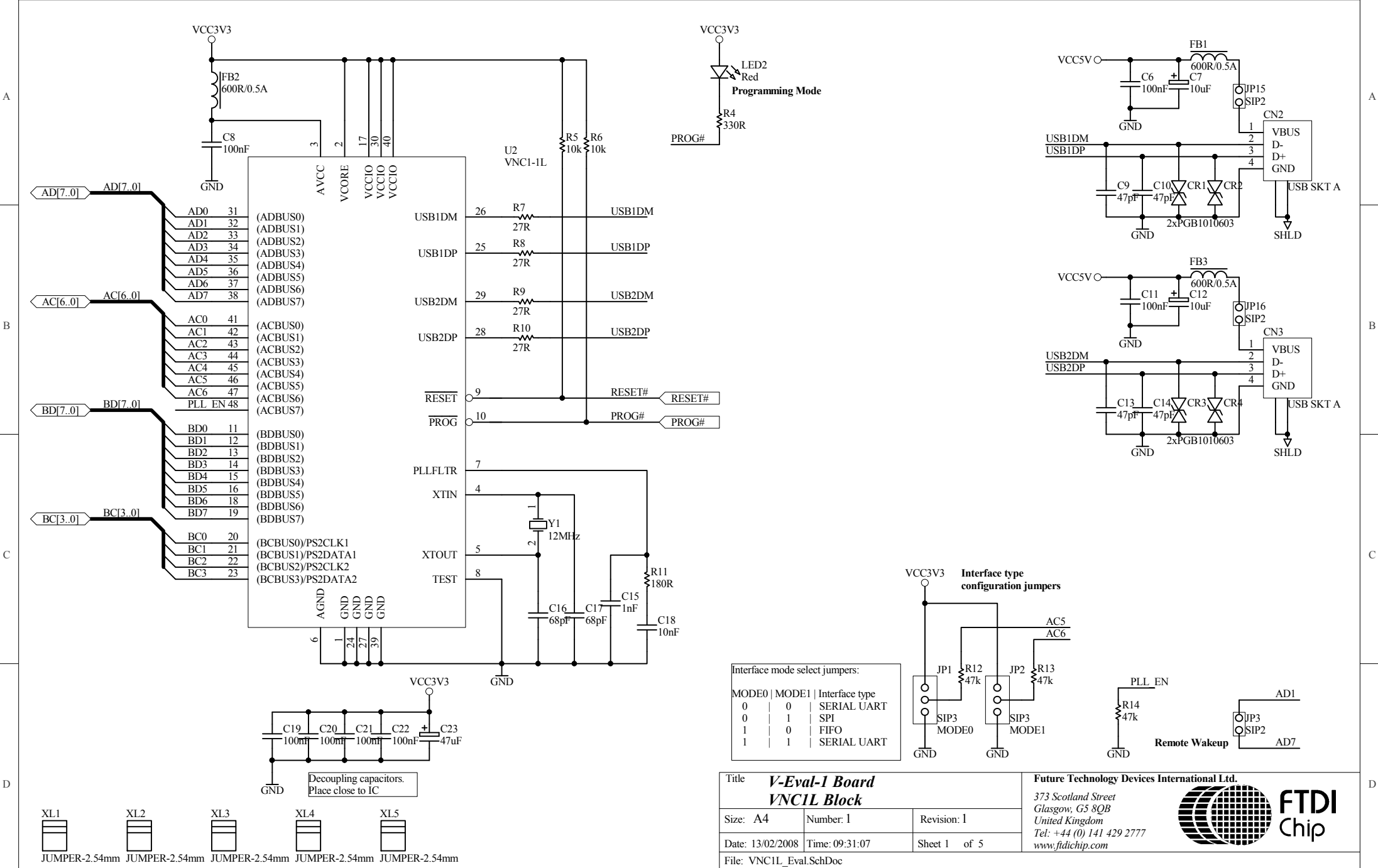

Interface mode select jumpers:

MODE0	MODE1	Interface type
0	0	SERIAL UART
0	1	SPI
1	0	FIFO
1	1	SERIAL UART

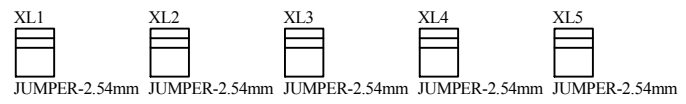
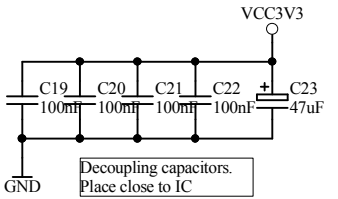
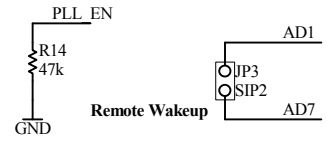

Title V-Eval-1 Board		Future Technology Devices International Ltd.	
Size: A4		Glasgow, G5 8QB	
Number: 1		United Kingdom	
Revision: 1		Tel: +44 (0) 141 429 2777	
Date: 13/02/2008	Time: 09:31:07	www.ftdichip.com	
File: VNC1L_Eval.SchDoc			

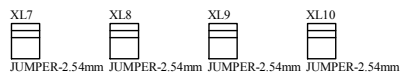
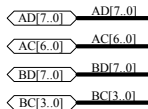
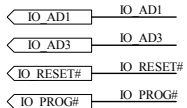
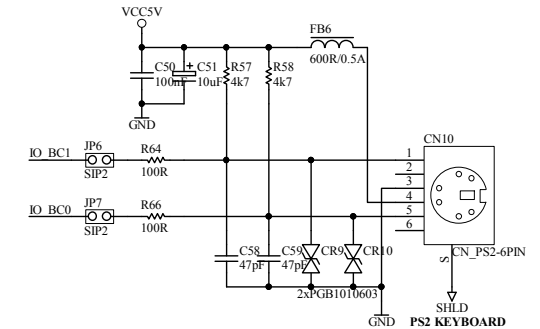
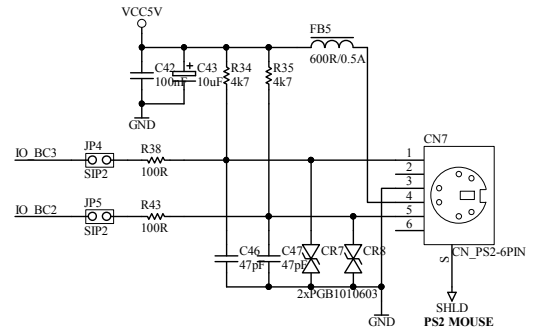
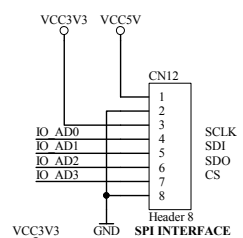
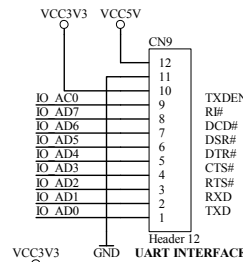
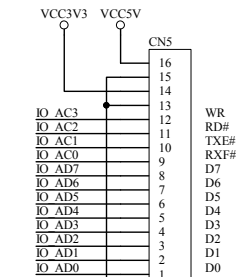
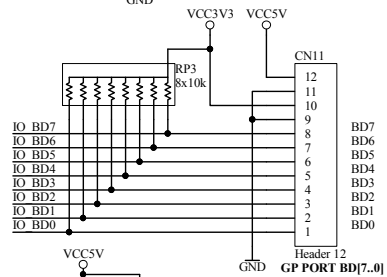
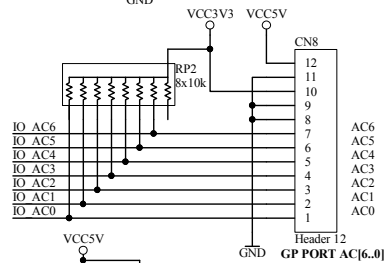
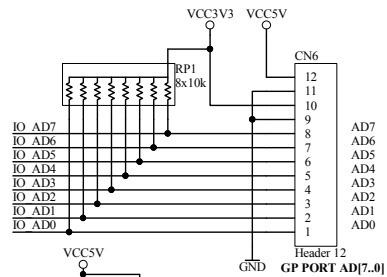
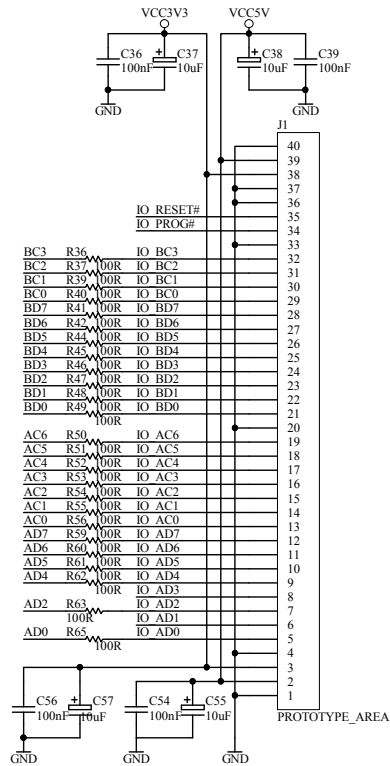

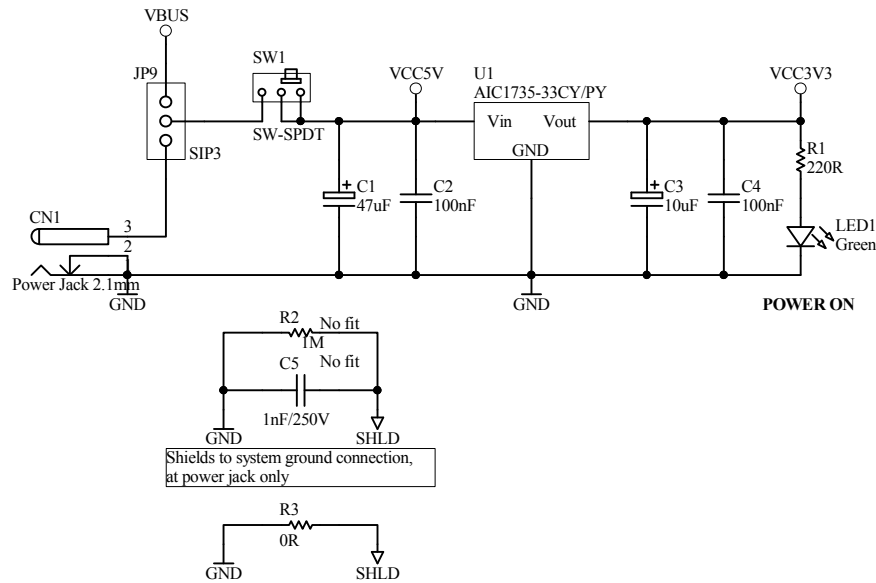

- FID1 FID2 MH1 MH2
-
- FID_MARK FID_MARK Mounting hole 3.5mm Mounting hole 3.5mm

- FID3 FID4 MH3 MH4
-
- FID_MARK FID_MARK Mounting hole 3.5mm Mounting hole 3.5mm

LOG1
 Vinculum Logo
 Logo Vinculum 15mm

XL16
 JUMPER-2.54mm

Title V-Eval-1 Board		Future Technology Devices International Ltd.	
Power Supply		373 Scotland Street Glasgow, G5 8QB United Kingdom	
Size: A4	Number: 5	Revision: 1	
Date: 13/02/2008	Time: 09:32:32	Sheet 5 of 5	
File: VNC1L_Eval_PWR.SchDoc		Tel: +44 (0) 141 429 2777 www.ftdichip.com	



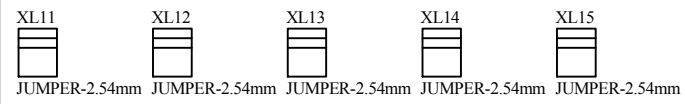
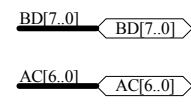
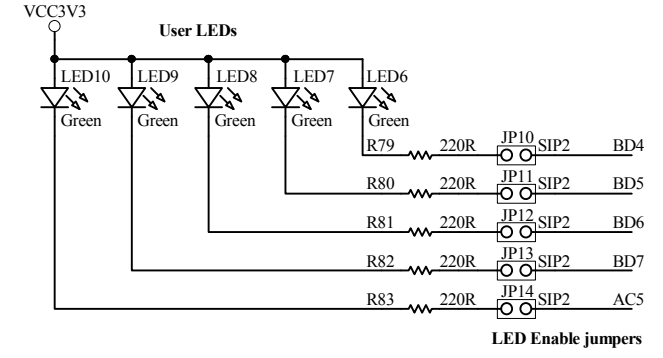
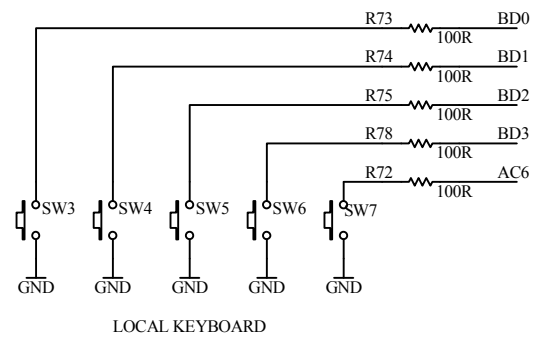
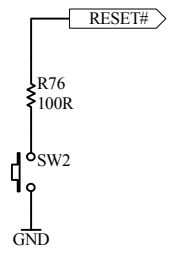

Title V-Eval-1 Board		Future Technology Devices International Ltd.	
Keyboard & LEDs		373 Scotland Street Glasgow, G5 8QB United Kingdom	
Size: A4	Number: 3	Revision: 1	
Date: 13/02/2008	Time: 09:32:59	Sheet 3 of 5	
File: VNC1L_Eval_KBRD_LEDS.SchDoc		Tel: +44 (0) 141 429 2777 www.ftdichip.com	



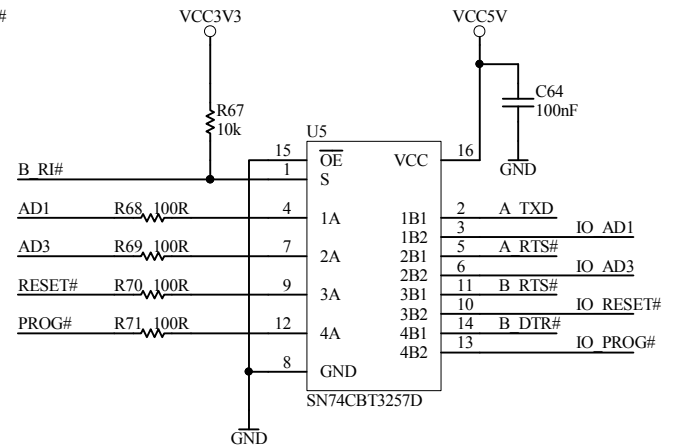
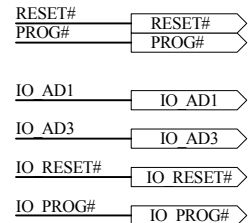
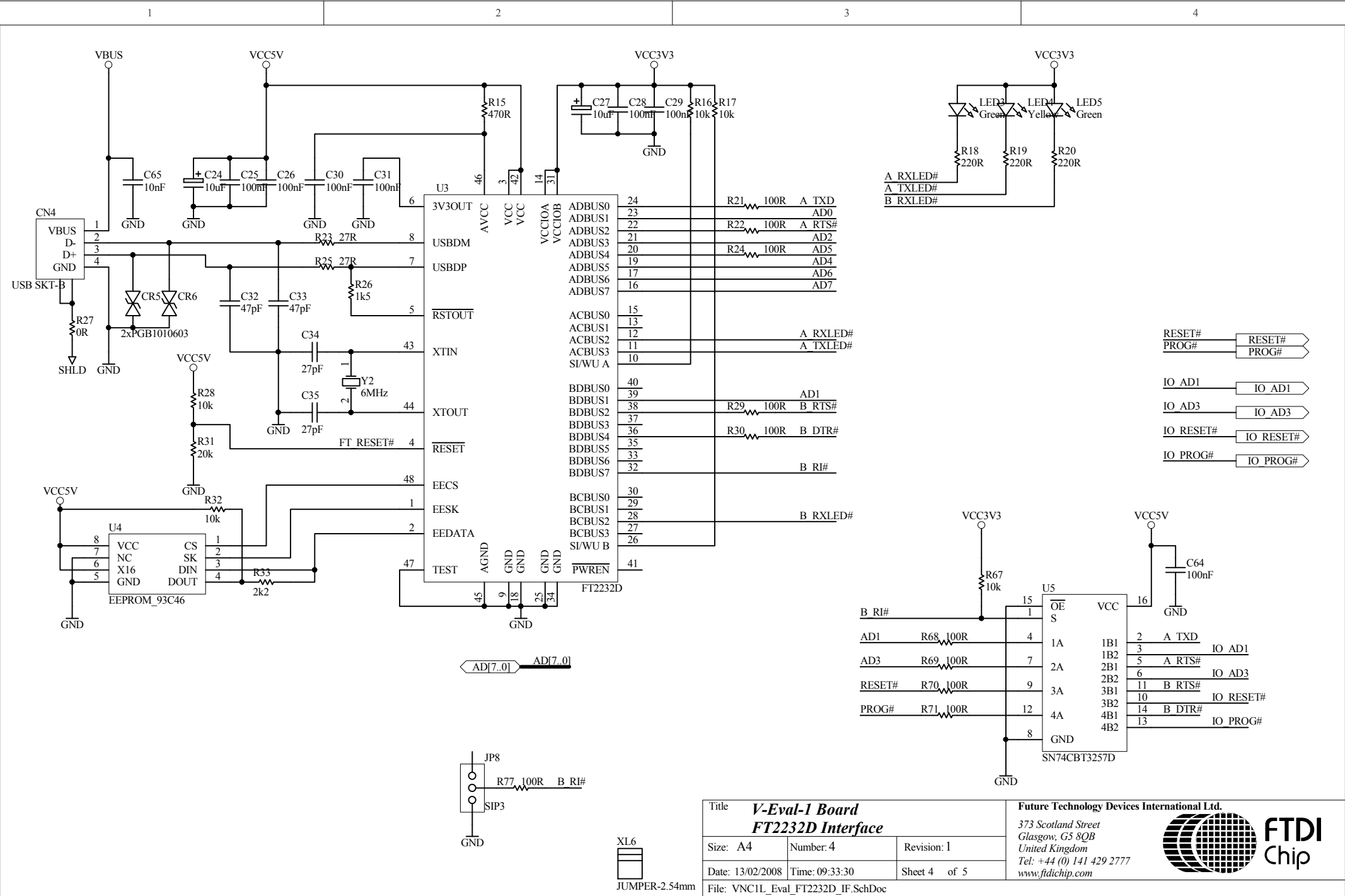

Title V-Eval-1 Board		Future Technology Devices International Ltd.	
Size: A4		373 Scotland Street	
Number: 4		Glasgow, G5 8QB	
Revision: 1		United Kingdom	
Date: 13/02/2008	Time: 09:33:30	Tel: +44 (0) 141 429 2777	
Sheet 4 of 5		www.ftdichip.com	

File: VNC1L_Eval_FT2232D_IF.SchDoc

