

## SPECIFICATION

- Part No. : **MA700.A.ABC.002**
- Product Name : Pantheon Antenna 3in1 MA.700  
Screw-Mount (Permanent Mount)  
GPS/GLONASS/GALILEO / LTE Cellular /  
2.4GHz / 5GHz  
Combination Antenna
- Features : Highest Efficiency/Peak Gain  
Omni-directional Outdoor IP67 Antenna  
Advanced RF Design and Materials  
Heavy Duty – Integrated Metal  
Base/Ground-plane  
Custom cables and connectors available  
RoHS ✓



## 1. Introduction

The Pantheon MA700 antenna is an omni-directional heavy-duty, fully IP67 waterproof external M2M antenna for use in telematics, transportation and remote monitoring applications. The Pantheon series is designed for RF professionals who accept no performance compromises whatsoever. The MA700 combines a 3in1 GPS/GLONASS/GALILEO, Cellular 700MHz to 2200MHz (4G/3G/2G) and 2.4GHz/5GHz antenna with the highest efficiency and peak gain possible. Unlike our competitors who don't measure cable loss the specification is measured at 3 meters (10ft) to show real performance in the field. The antenna screws down permanently onto a roof or metal panel and can be pole or wall-mounted.

All while still maintaining 20dB isolation between antennas. It uses high-shielded PTFE dielectric ultra low-loss cables that maintain low attenuation at all frequency bands, and high noise rejection, with an average loss of only 0.3dB per meter (0.1dB per foot), compared to 0.7dB for RG58 and 1.2dB for RG174. Because of this, the Pantheon maximizes chances of passing PTCRB and network approvals first time. The Pantheon also has excellent performance without need to attach to an external ground-plane due to its internal antennas coupling to its unique super strong integrated metal base. The antenna comes with a 3M adhesive waterproof layer to prevent water leaking under the antenna into the mounting hole. The Pantheon can also be supplied in single GPS/GLONASS/GALILEO, Cellular, Wi-Fi only versions, or at other frequencies.

Custom designed integrated wall mounted and pole mounted brackets are available for the Pantheon antennas. These patent pending mounts allow for 180 degrees freedom of movement of the antennas for ease of positioning while also preventing access to the cables so they cannot be cut by vandals or thieves and also protecting the cables from long term weather exposure. The removal of unsightly cables also leads to a cleaner more professional installation and look, and makes the antenna less identifiable and more unobtrusive. Customized cable sleeves can be supplied for extra protection where required.



Note: for ground-isolation antennas use the MA705 version with Isolation Gaskets.

## 2. Specification

GPS-GLONASS-GALILEO						
Centre Frequency	1575.42MHz / 1602MHz					
Bandwidth	10MHz					
Radiation Efficiency	50(without cable)					
Passive Gain @ Zenith	4.0 typ(with $\psi=140$ mm ground)					
VSWR	2					
Impedance	50 $\Omega$					
DC Power Input Range	3 ~ 5V					
DC input	<b>3.3V</b>		<b>4.0V</b>		<b>5.5V</b>	
<b>MHz</b>	<b>1575.42</b>	<b>1602</b>	<b>1575.42</b>	<b>1602</b>	<b>1575.42</b>	<b>1602</b>
VSWR	2	2	2	2	2	2
LNA Gain	29.2	29	31	31	32.3	32
Noise Figure	3.1	3.1	3.2	3.2	3.4	3.4
Power Consumption	7.5	7.5	9.4	9.4	15	15
Band Attenuation	1520MHz: -20dB 1642MHz: -20dB		1520MHz: -20dB 1642MHz: -20dB		1520MHz: -20dB 1642MHz: -20dB	
Cable	3m RG-174 standard, fully customizable					
Connector	SMA(M) standard, fully customizable					

CELLULAR ANTENNA						
Frequency (MHz)	700~ 800	824 ~ 896	880 ~ 960	1710~ 1880	1850~1990	1710~2170
Peak Gain (dBi)	2.4	1.6	1.7	2.1	2.4	2.4
Average Gain (dBi)	-1.3	-2.0	-2.3	-2.8	-2.7	-2.7
Efficiency	73%	61%	58%	52%	52%	52%
Impedance	50 $\Omega$					
Polarization	Linear					
Radiation Pattern	Omni					
Cable	3m CFD200 standard, fully customizable					
Connector	SMA(M) standard, standard, fully customizable					

2.4GHz / 5GHz ANTENNA				
Frequency (GHz)	2.4 ~ 2.5	4.7 ~ 5.0	5.0 ~ 5.4	5.4 ~ 5.9
Peak Gain (dBi)	2.1	2.9	3.8	2.8
Average Gain (dBi)	-2.3	-3.6	-3.3	-3.8
Efficiency	60%	44%	46%	42%
VSWR	<=1.7:1			
Impedance	50Ω			
Polarization	Linear			
Radiation Pattern	Omni			
Cable	3m CFD200 standard, fully customizable			
Connector	RP-SMA(M) standard, standard, fully customizable			
MECHANICAL				
Dimensions	Height 85.7mm x Diameter 145.6mm			
Casing	Wonderloy PC-540 PC/ABS Alloy			
Base and thread	CAN10 Zinc Alloy			
Thread diameter	M30 x 2 (30mm)			
Nut	Nickel Plated Iron			
Foam	3M 9448HK			
Waterproof	IP67			
ENVIRONMENTAL				
Operation Temperature	-30°C to 85°C			
Storage Temperature	-40°C to 90°C			
Humidity	Non-condensing 65°C 95% RH			

\* all measurement are done in free space with 3m standard cable

LTE BANDS			
Band Number	LTE / LTE-Advanced / WCDMA / HSPA / HSPA+ / TD-SCDMA		
	Uplink	Downlink	Covered
1	UL: 1920 to 1980	DL: 2110 to 2170	✓
2	UL: 1850 to 1910	DL: 1930 to 1990	✓
3	UL: 1710 to 1785	DL: 1805 to 1880	✓
4	UL: 1710 to 1755	DL: 2110 to 2155	✓
5	UL: 824 to 849	DL: 869 to 894	✓
7	UL: 2500 to 2570	DL: 2620 to 2690	✗
8	UL: 880 to 915	DL: 925 to 960	✓
9	UL: 1749.9 to 1784.9	DL: 1844.9 to 1879.9	✓
11	UL: 1427.9 to 1447.9	DL: 1475.9 to 1495.9	✗
12	UL: 699 to 716	DL: 729 to 746	✓
13	UL: 777 to 787	DL: 746 to 756	✓
14	UL: 788 to 798	DL: 758 to 768	✓
17	UL: 704 to 716	DL: 734 to 746 (LTE only)	✓
18	UL: 815 to 830	DL: 860 to 875 (LET only)	✓
19	UL: 830 to 845	DL: 875 to 890	✓
20	UL: 832 to 862	DL: 791 to 821	✓
21	UL: 1447.9 to 1462.9	DL: 1495.9 to 1510.9	✗
22	UL: 3410 to 3490	DL: 3510 to 3590	✗
23	UL: 2000 to 2020	DL: 2180 to 2200 (LTE only)	✓
24	UL: 1625.5 to 1660.5	DL: 1525 to 1559 (LTE only)	✓
25	UL: 1850 to 1915	DL: 1930 to 1995	✓
26	UL: 814 to 849	DL: 859 to 894	✓
27	UL: 807 to 824	DL: 852 to 869 (LTE only)	✓
28	UL: 703 to 748	DL: 758 to 803 (LTE only)	✓
29	UL: -	DL: 717 to 728 (LTE only)	✓
30	UL: 2305 to 2315	DL: 2350 to 2360 (LTE only)	✓
31	UL: 452.5 to 457.5	DL: 462.5 to 467.5 (LTE only)	✗
32	UL: -	DL: 1452 - 1496	✗
35		1850 to 1910	✓
38		2570 to 2620	✗
39		1880 to 1920	✓
40		2300 to 2400	✗
41		2496 to 2690	✗
42		3400 to 3600	✗
43		3600 to 3800	✗

\*Covered bands represent an efficiency greater than 20%

# 3. GPS/GLONASS/GALILEO Antenna Characteristics

## 3.1. Block diagram

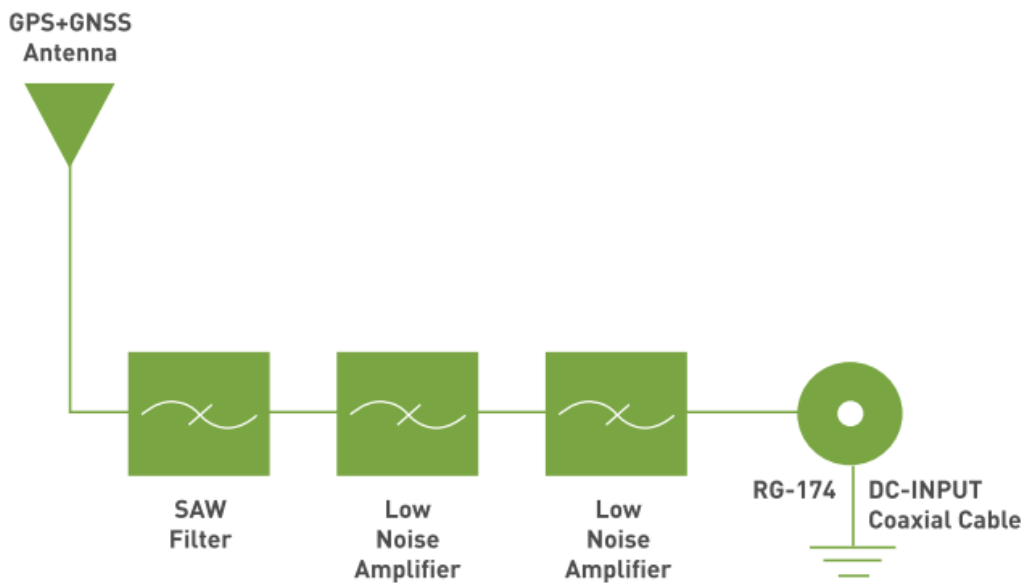

## 3.2. Return Loss

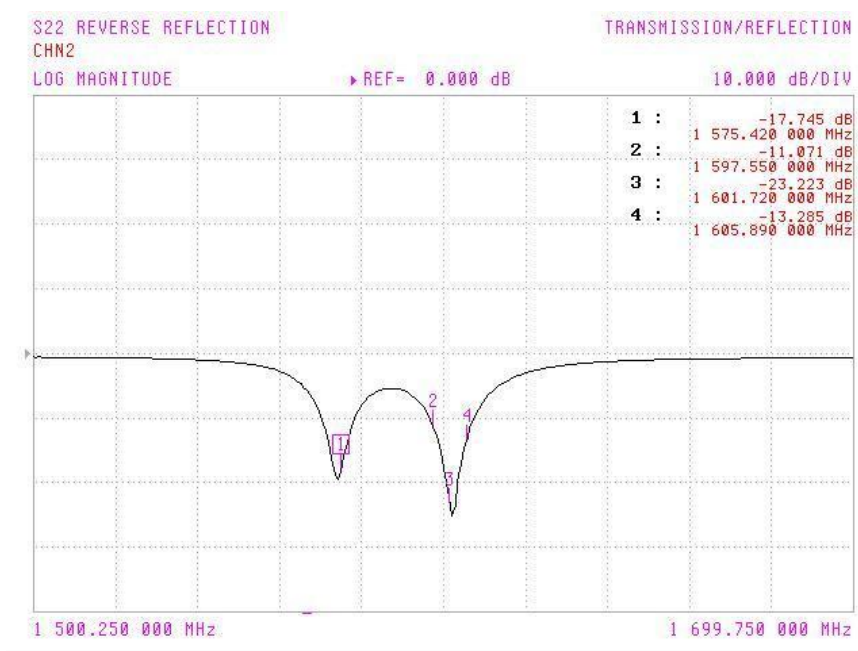

### 3.3. GPS/GLONASS/GALILEO Antenna Radiation Pattern

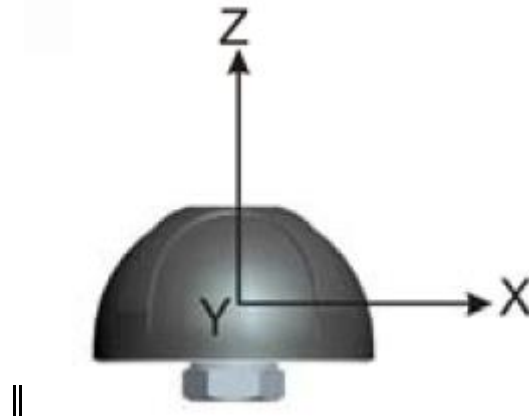

XYZ co-ordinate for reference.

XZ-plane Free Space @1575.42MHz

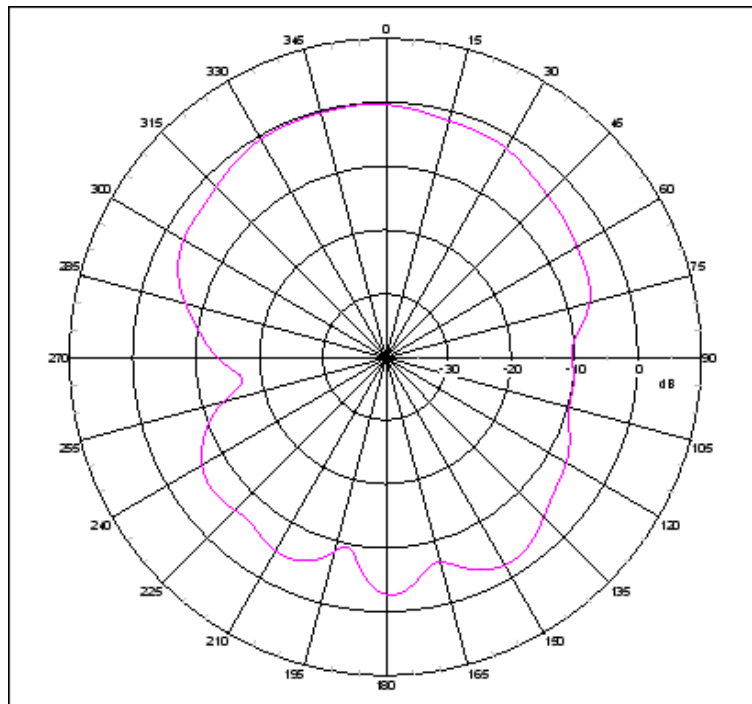

YZ-plane Free Space @1575.42MHz

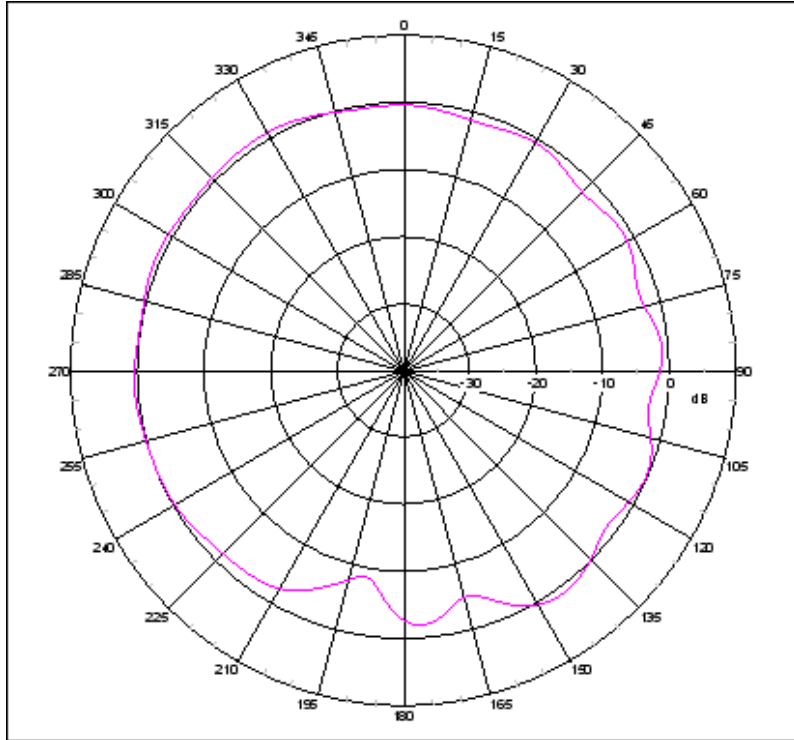

XZ-plane Free Space @1602MHz

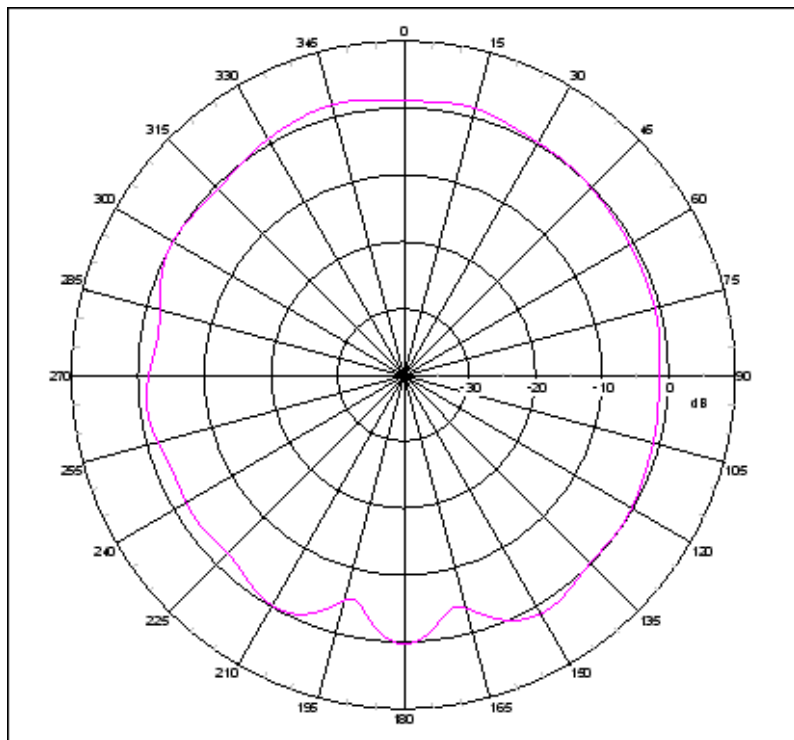





### YZ-plane Free Space @1602MHz

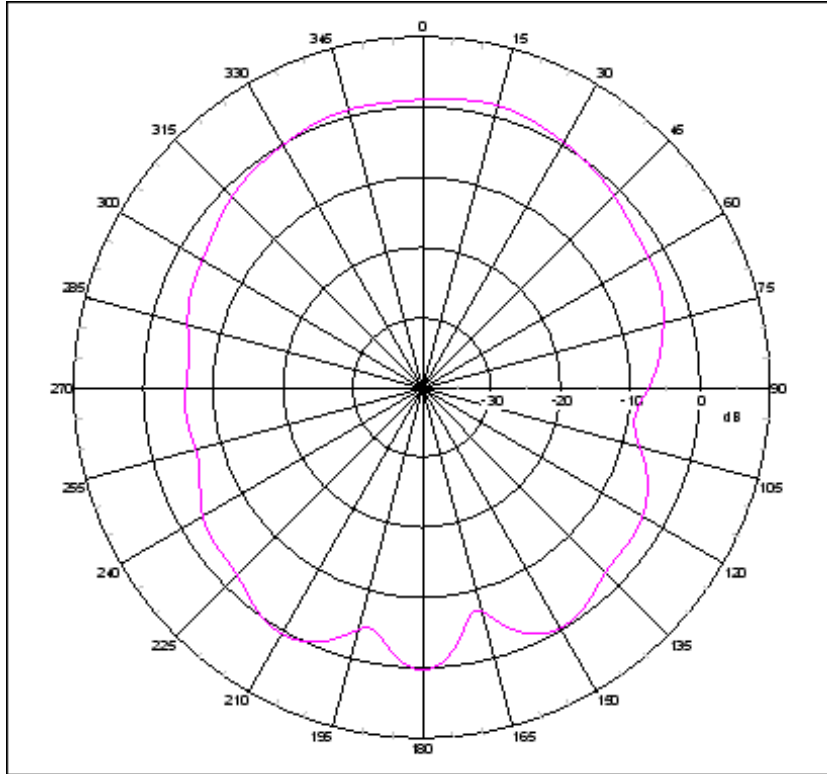

### 3.4. GPS/GLONASS/GALILEO LNA

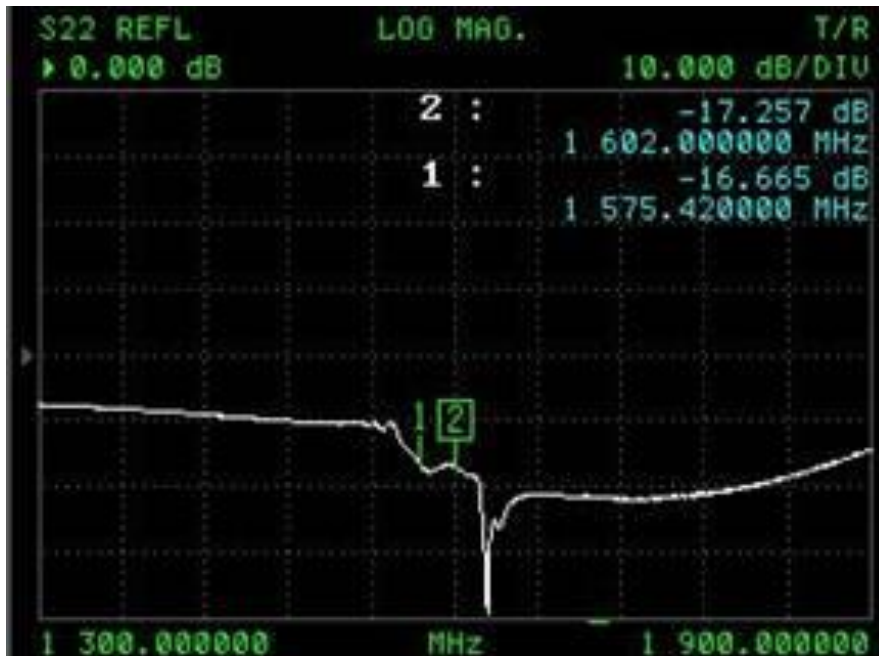
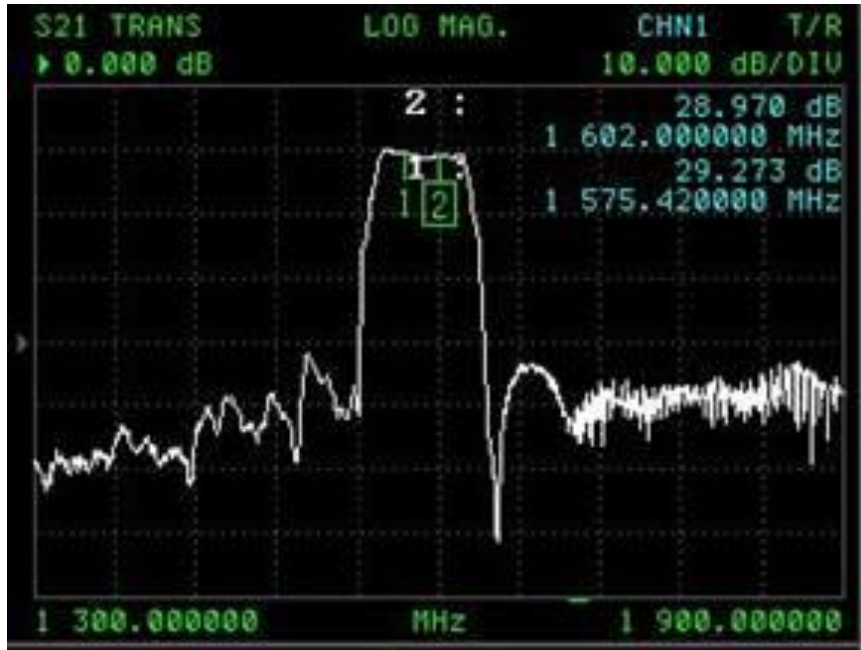

## 4. Cellular Antenna Characteristics

### 4.1. Return Loss (Free Space)

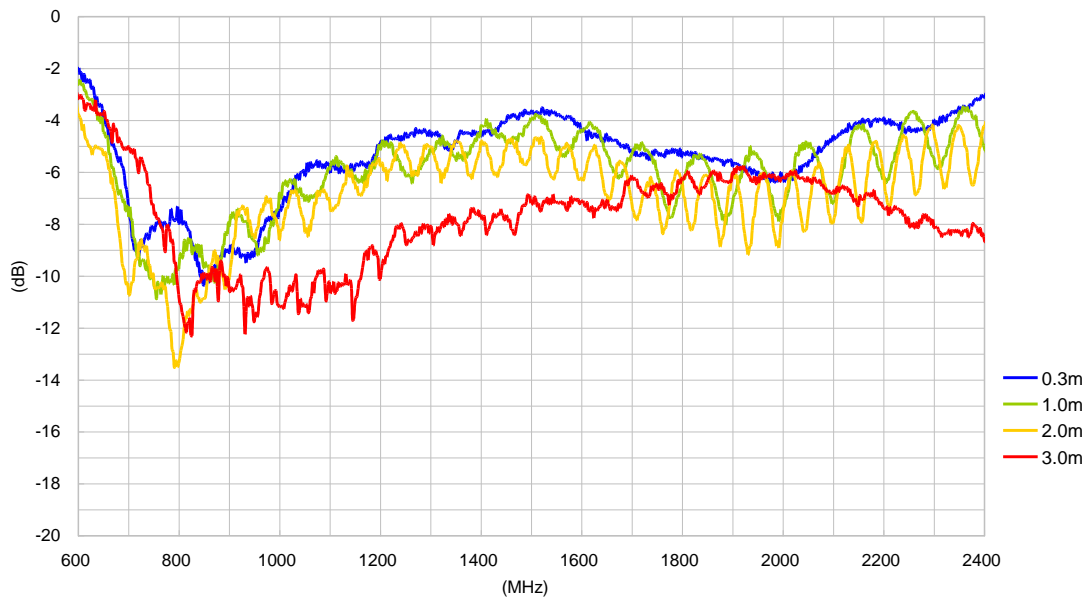

### 4.2. Return Loss (45 x 30cm Ground Plane)

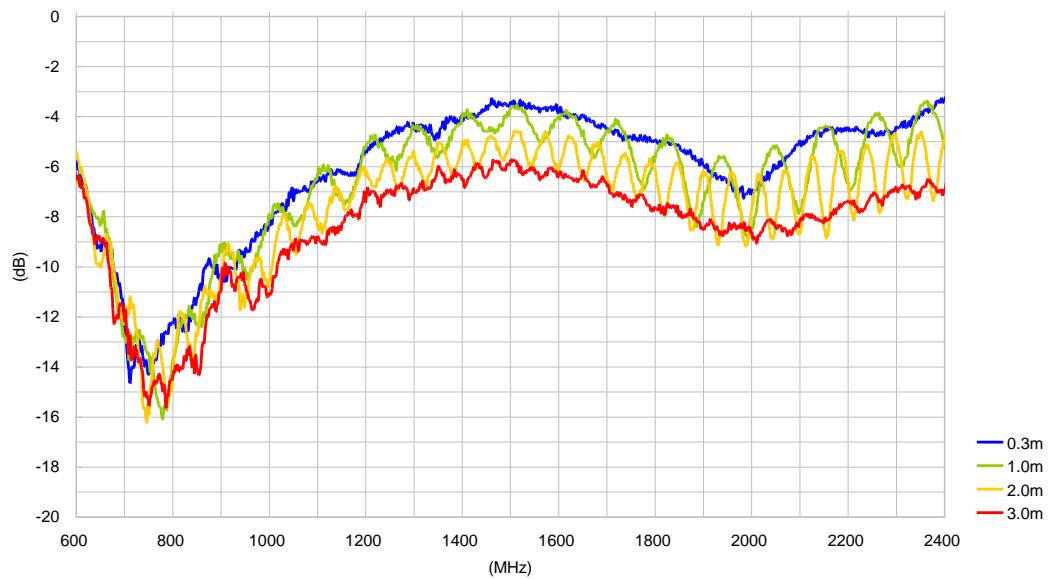

### 4.3. VSWR (Free Space)

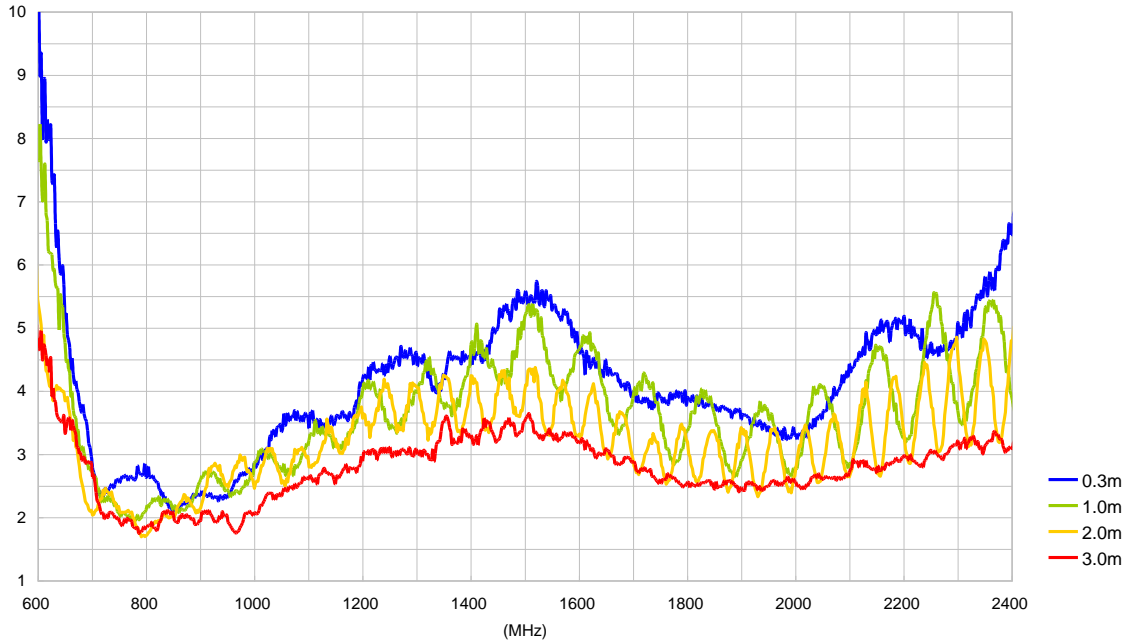

### 4.4. VSWR (45cm x 30cm Ground Plane)

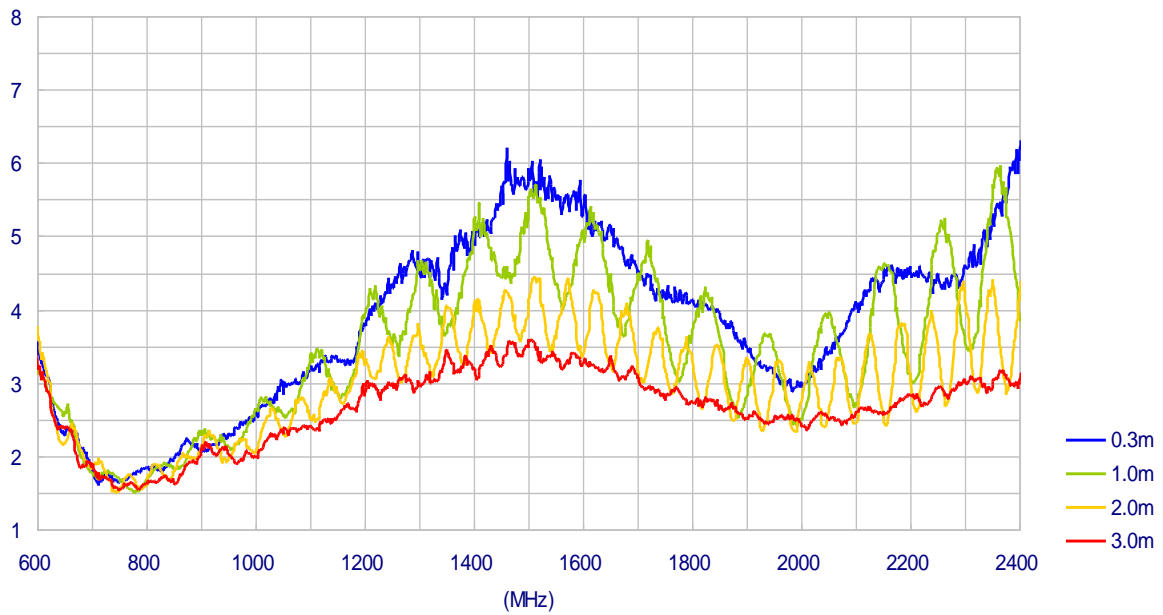

### 4.5. Cellular Antenna Free Space Efficiency

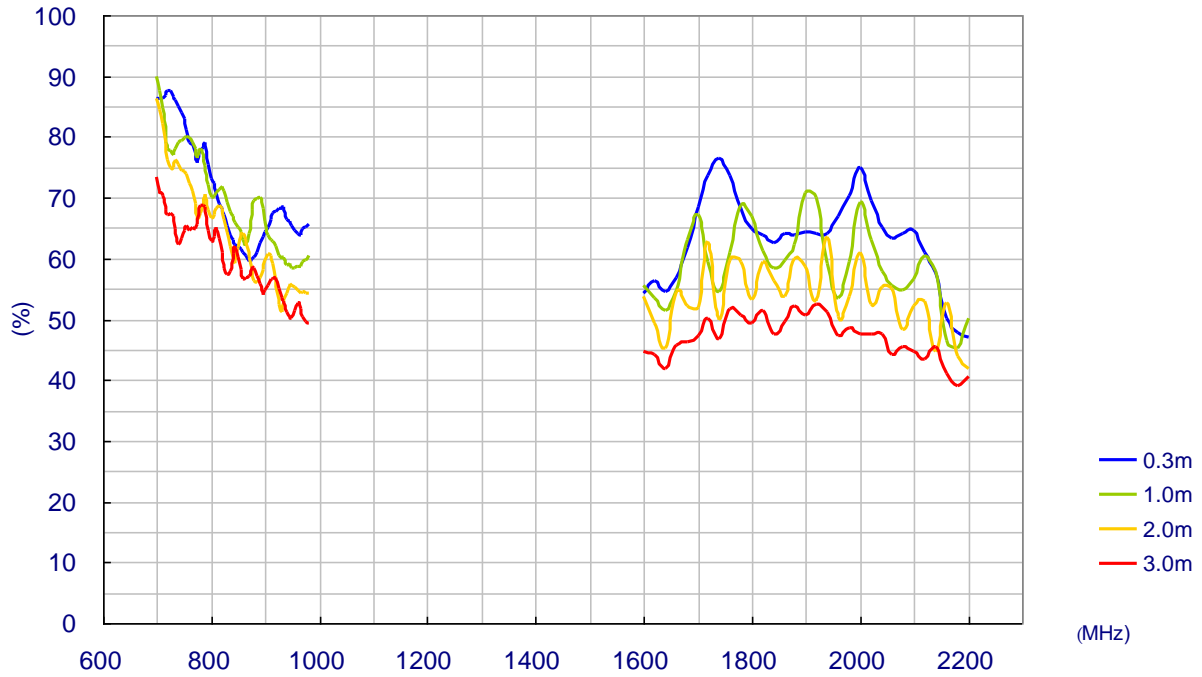

### 4.6. Cellular Antenna Free Space Peak Gain

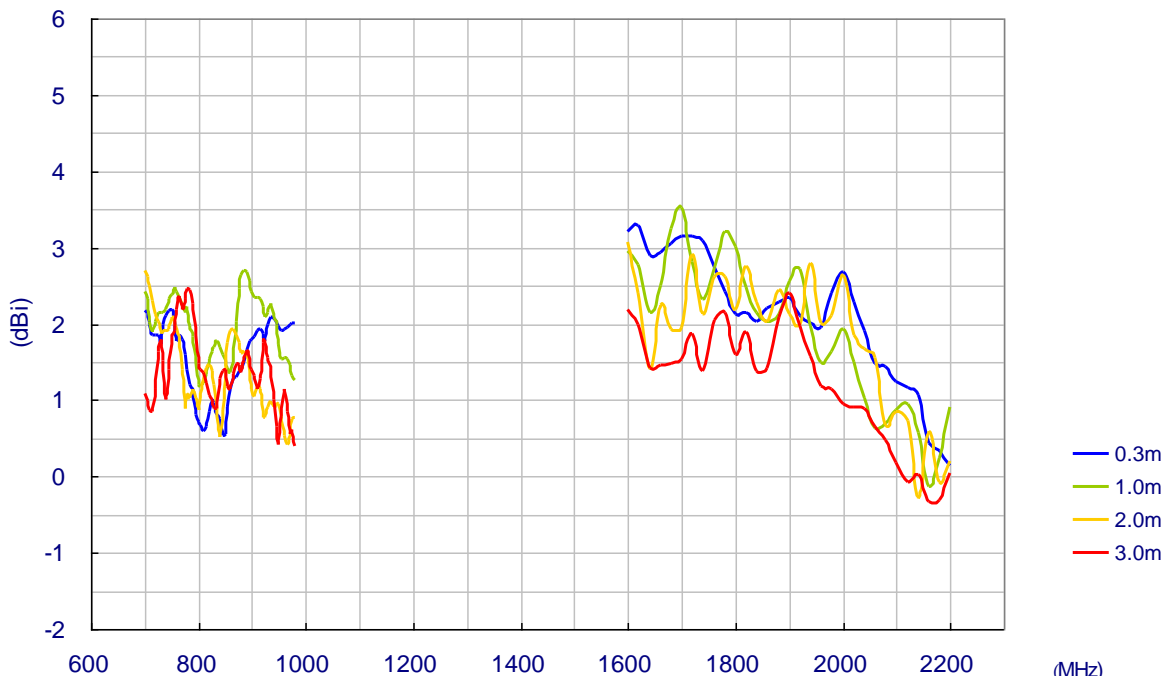

### 4.7. Cellular Antenna Free Space 3D Average Gain

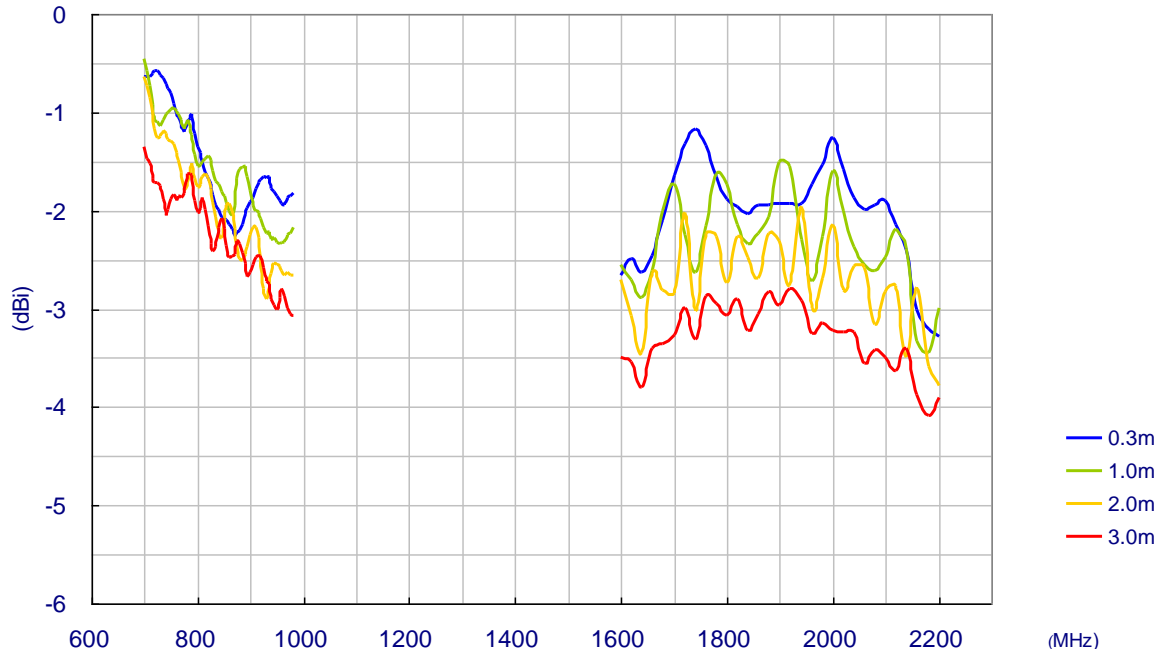

## 4.8. Cellular Antenna Free Space Radiation

XZ Plane at 800MHz

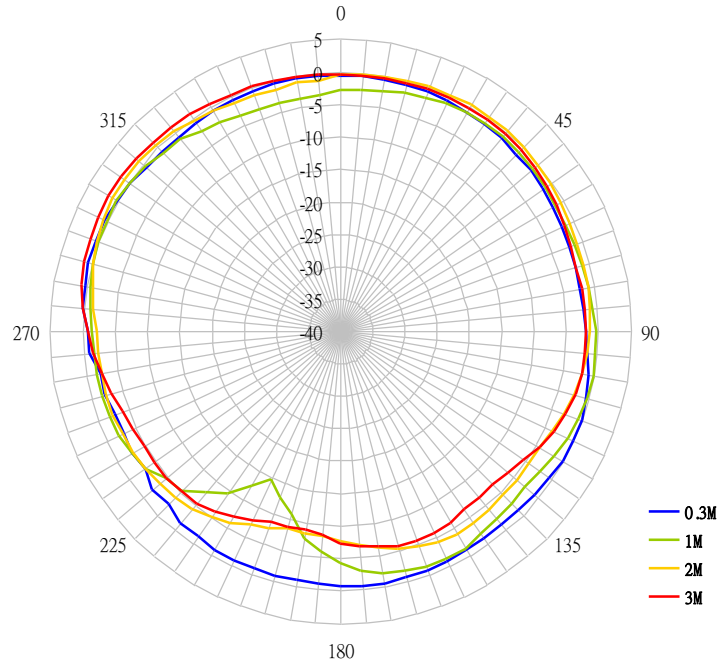

YZ Plane at 800MHz

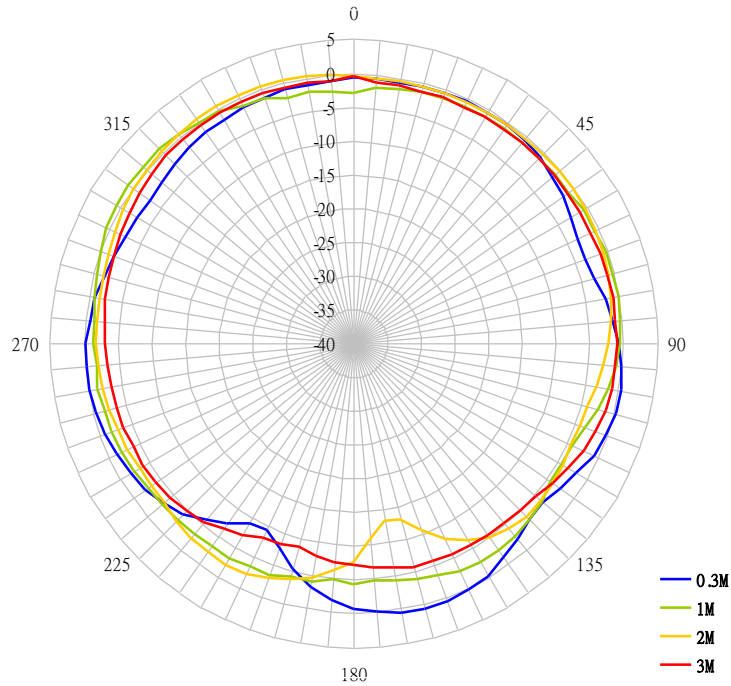

XY Plane at 800MHz

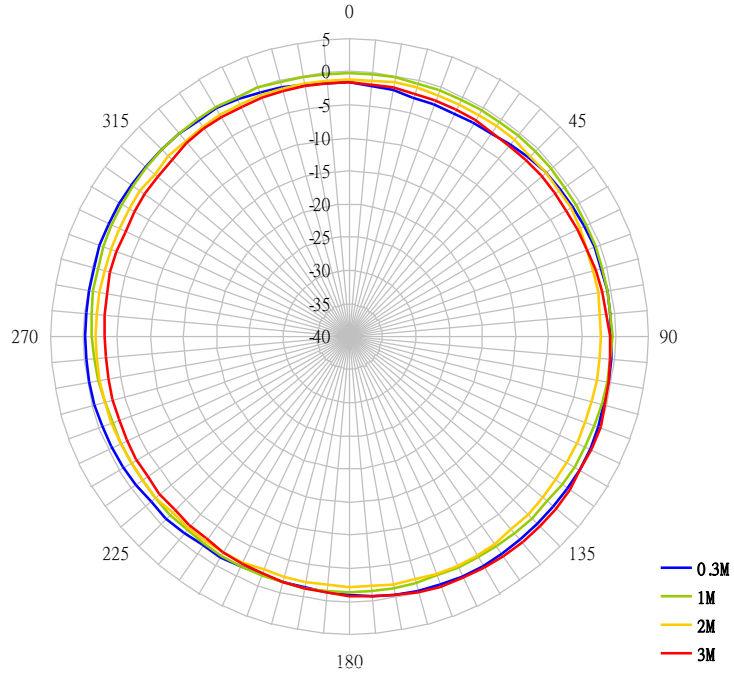

XZ Plane at 900MHz

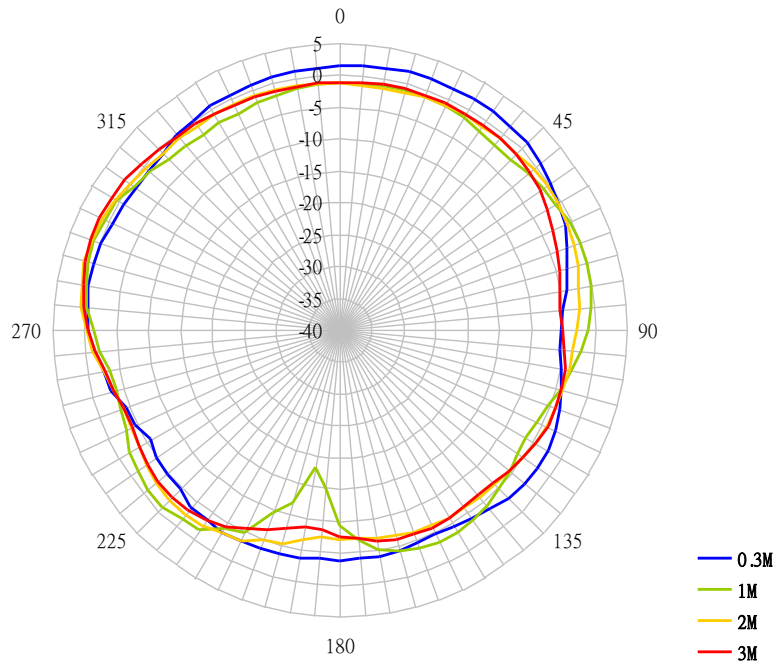



YZ Plane at 900MHz

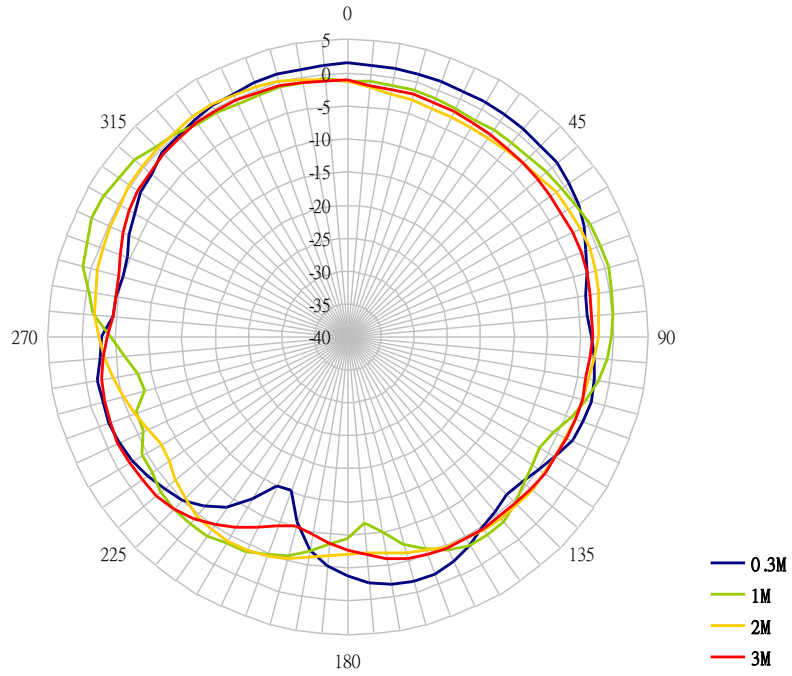

XY Plane at 900MHz

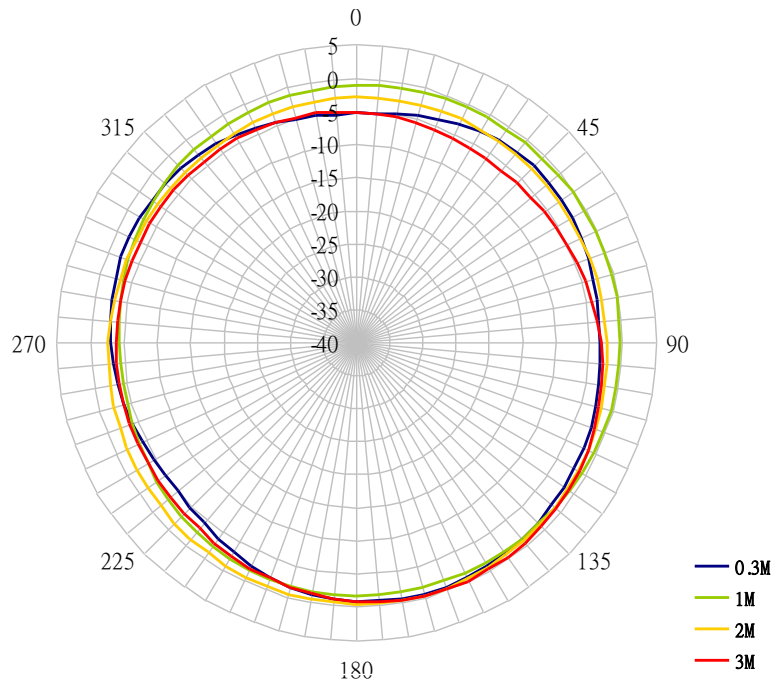

XZ Plane at 1800MHz

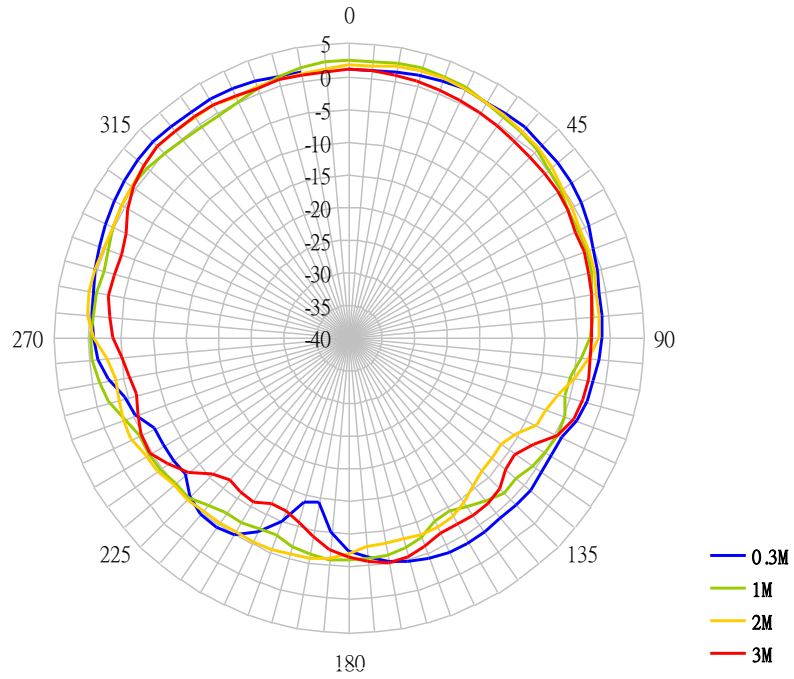

YZ Plane at 1800MHz

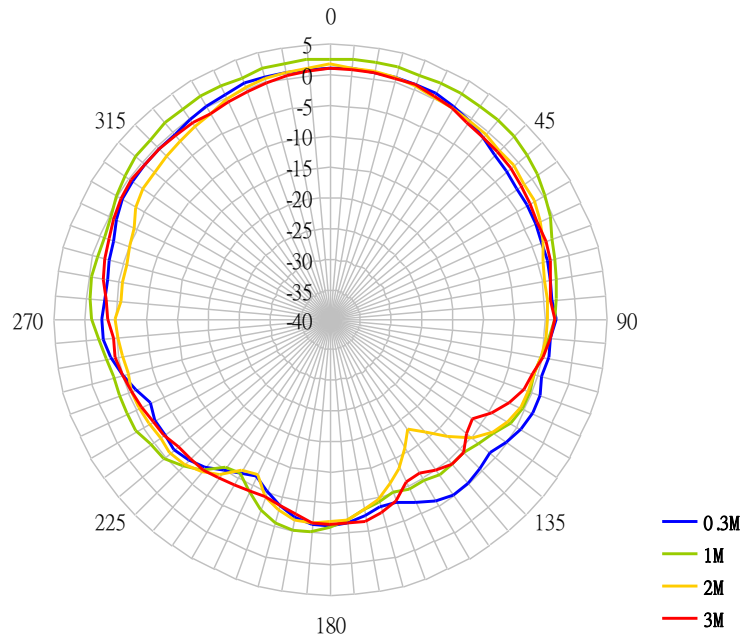

XY Plane at 1800MHz

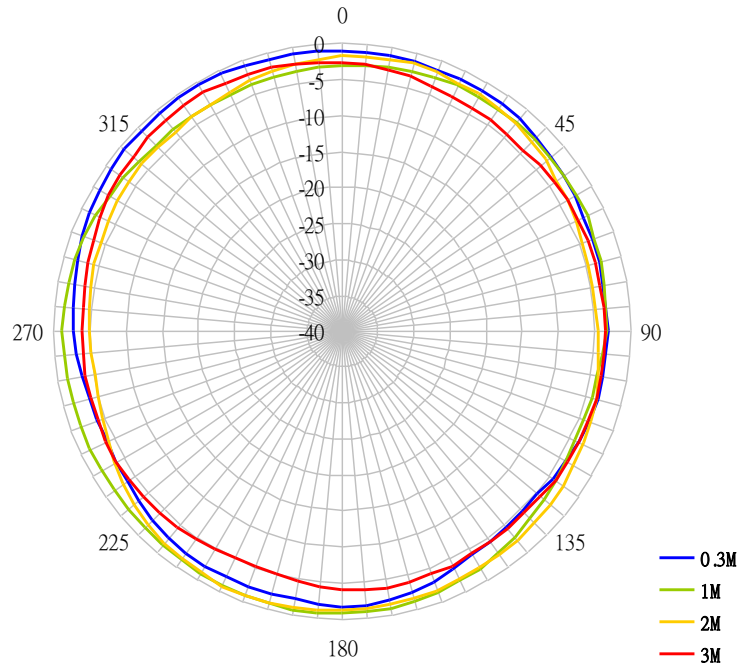

XZ Plane at 1900MHz

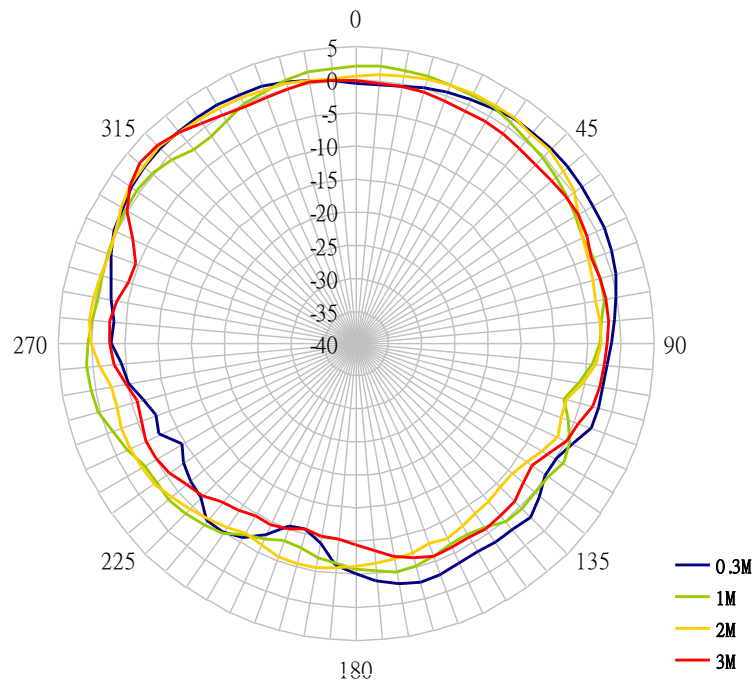

YZ Plane at 1900MHz

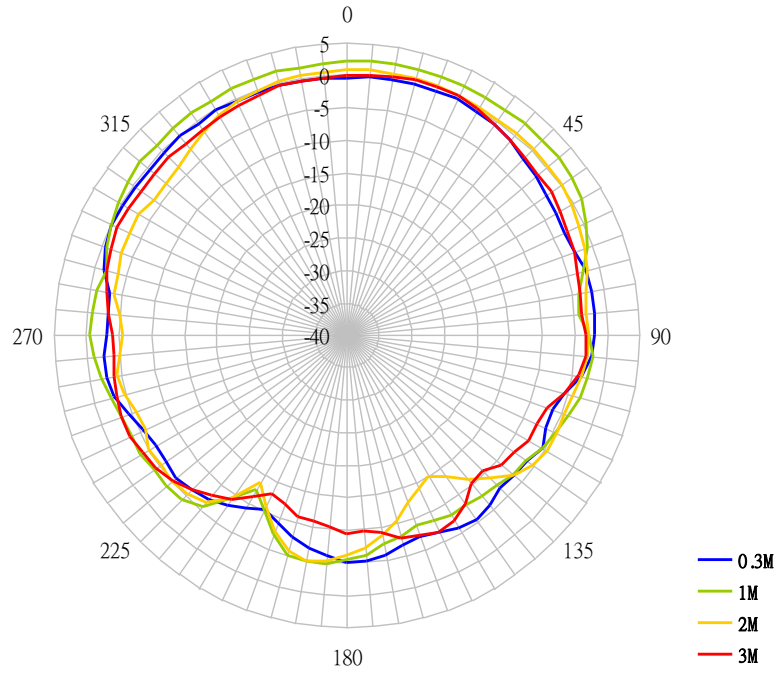

XY Plane at 1900MHz

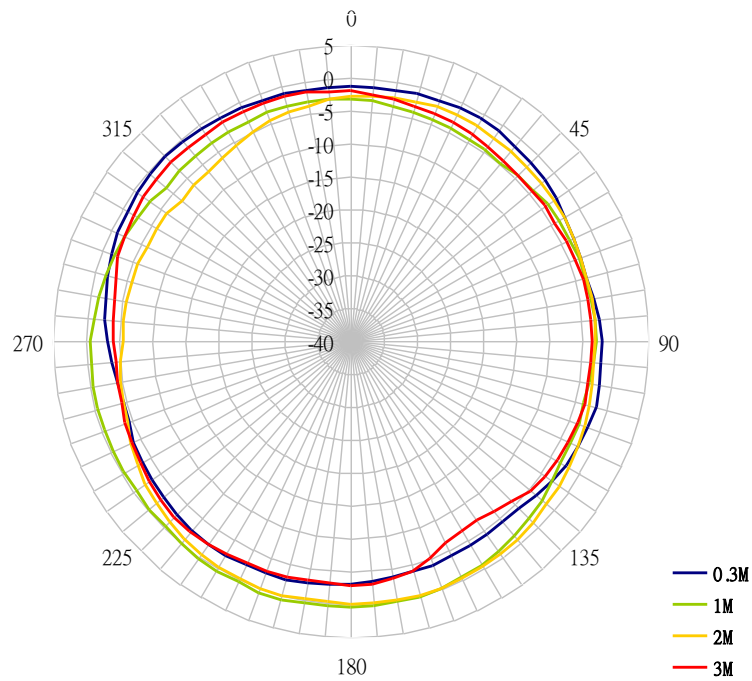

XZ Plane at 2200MHz

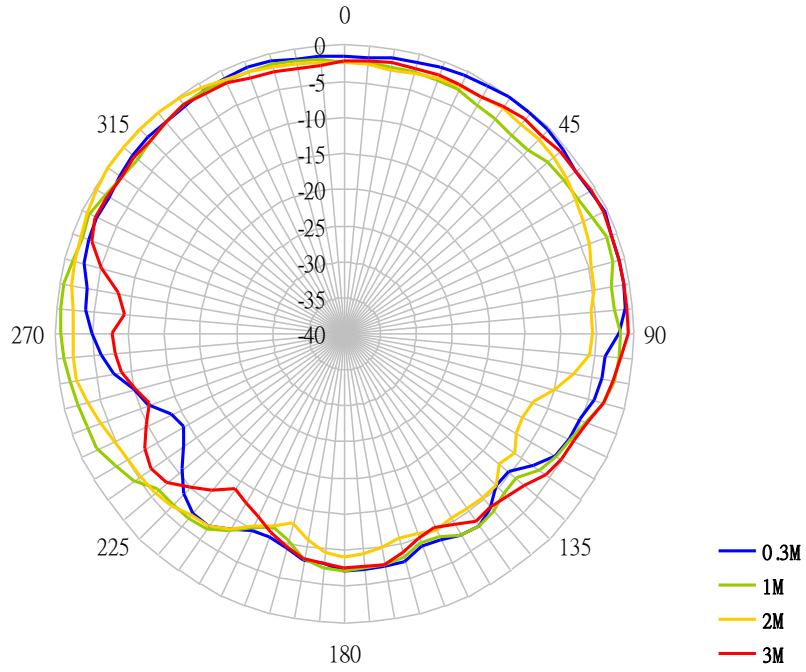

YZ Plane at 2200MHz

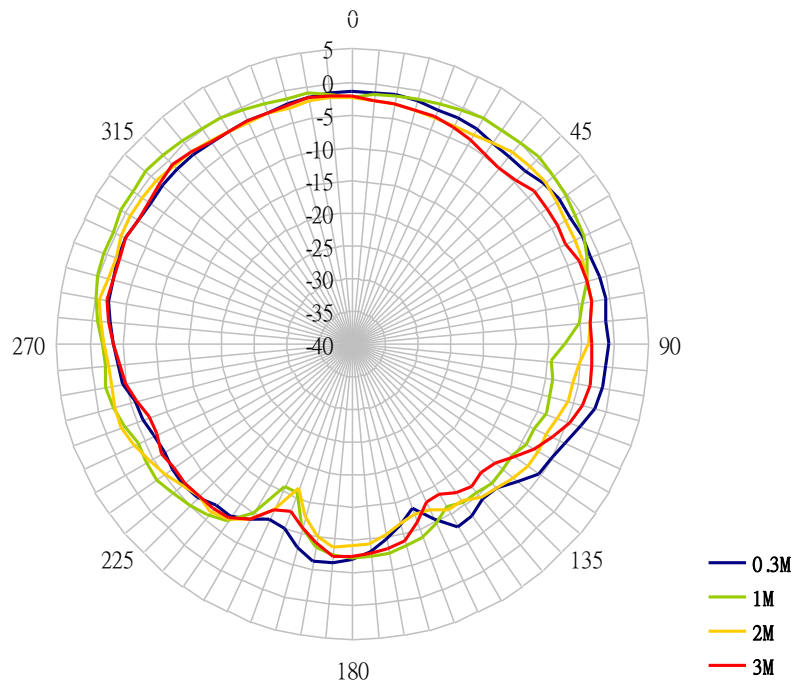

XY Plane at 2200MHz

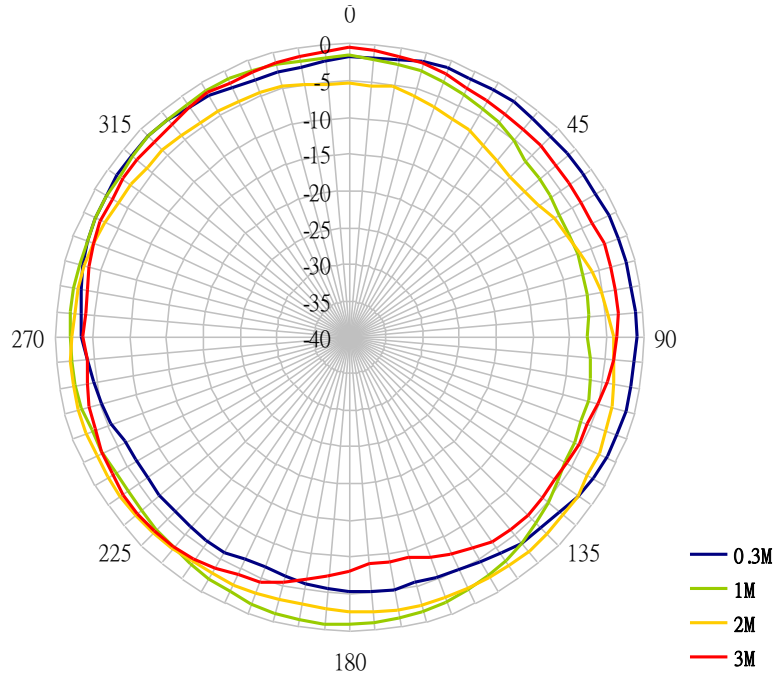

## 5. 2.4/5GHz Antenna Characteristics

### 5.1. S11 Return Loss (Free Space)

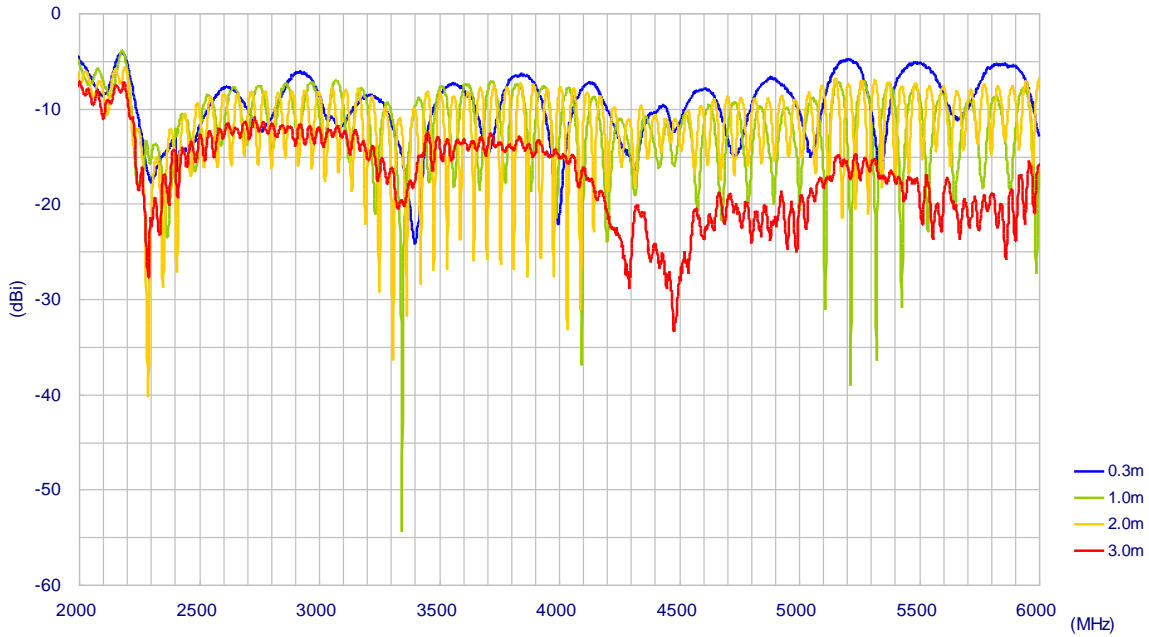

### 5.2. S11 Return Loss (45cm x 30cm Ground Plane)

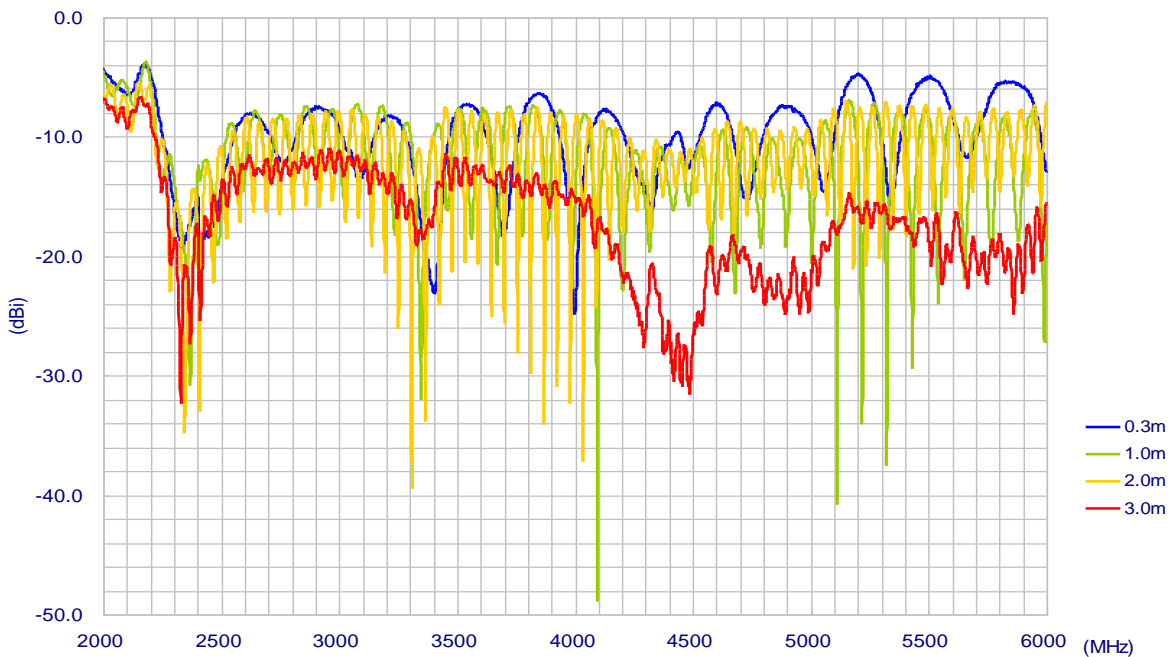

### 5.3. VSWR (Free Space)

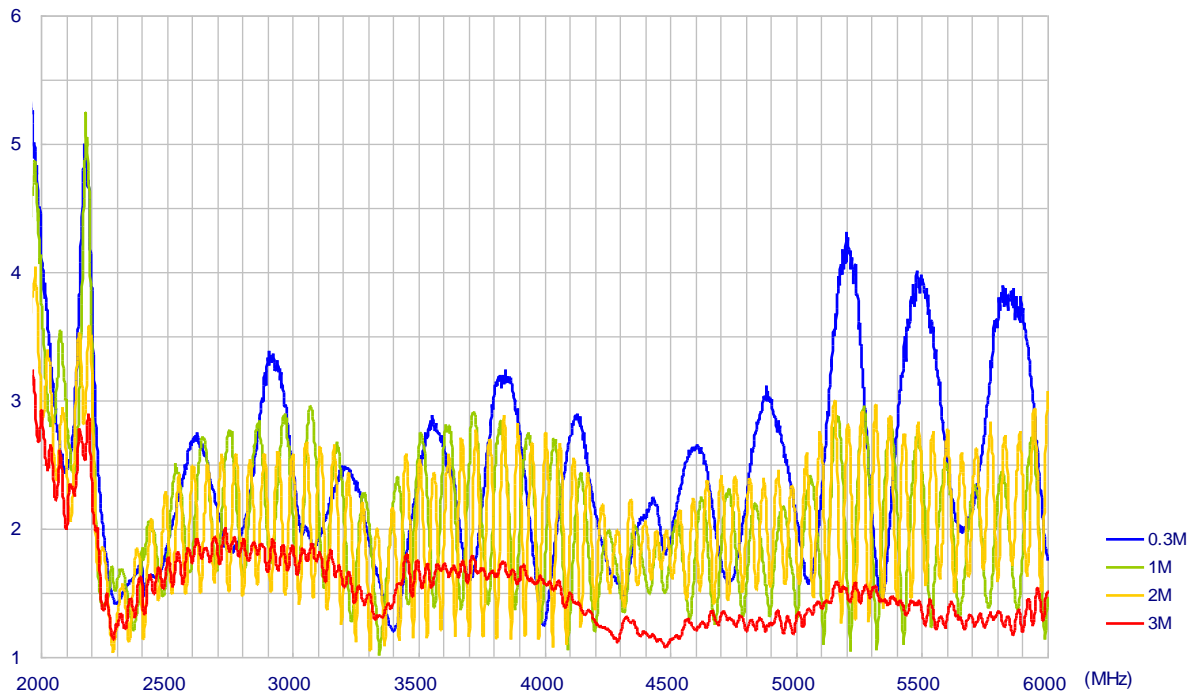

### 5.4. VSWR (45cm x 30cm Ground Plane)

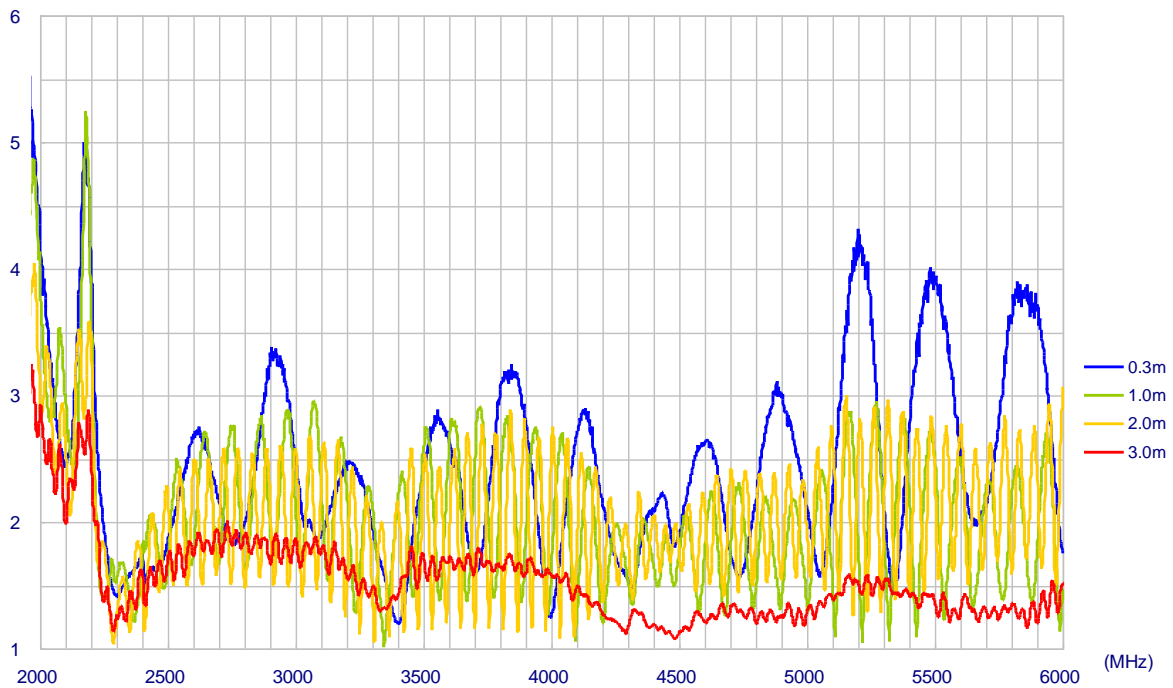



### 5.5. 2.4/5GHz Antenna Free Space Efficiency (3m Cable)

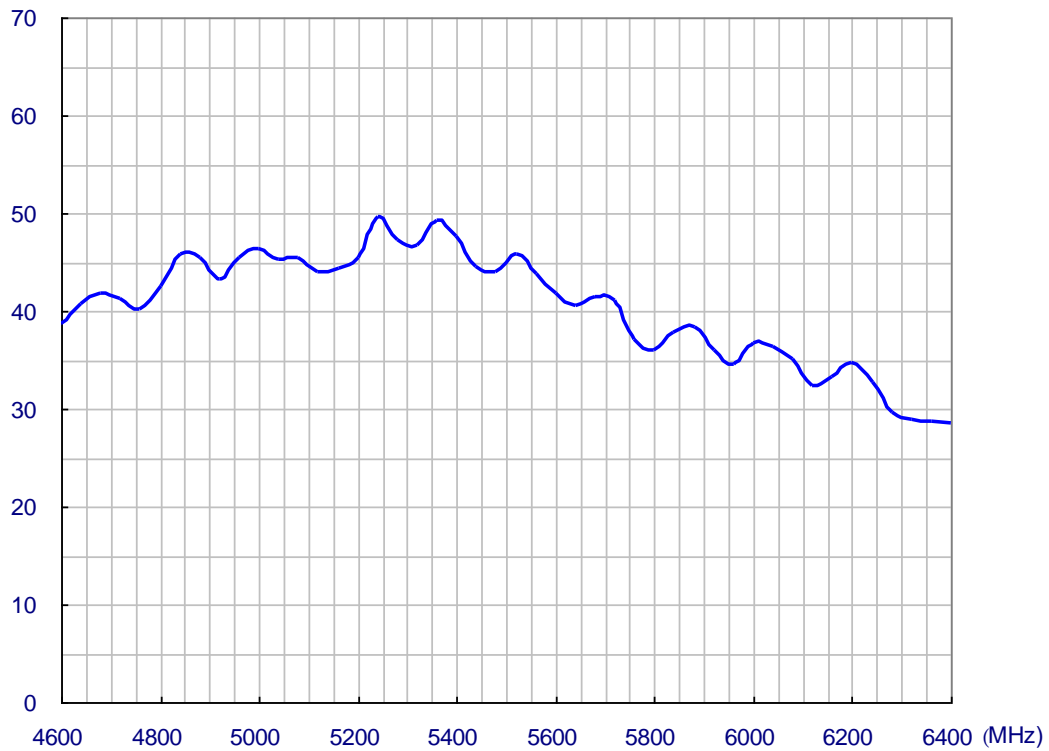
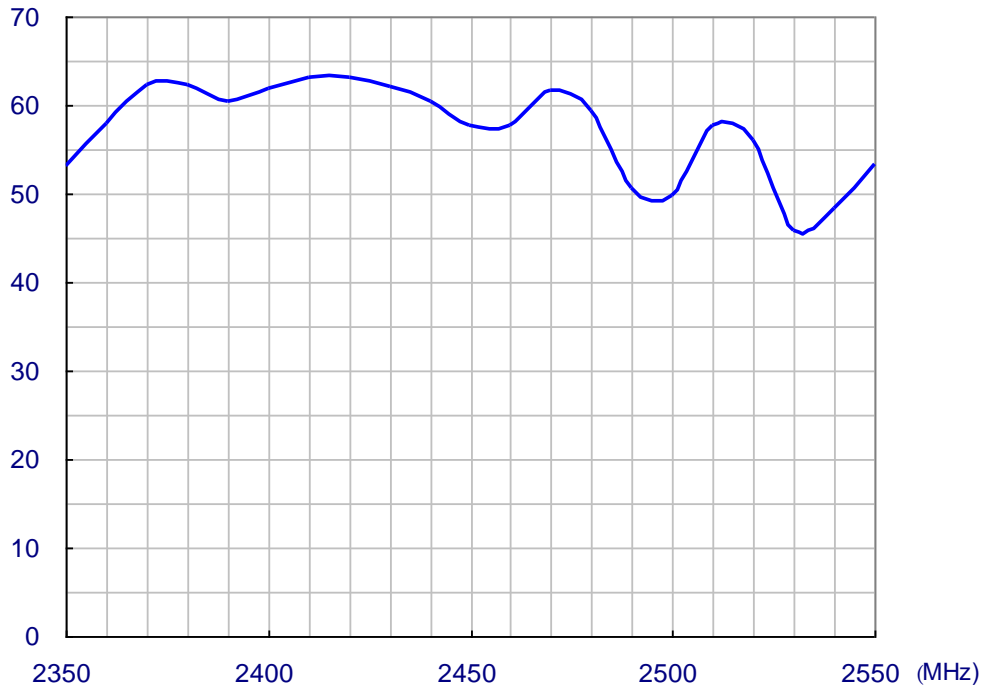

### 5.6. 2.4/5GHz Antenna Free Space Peak Gain (3m Cable)

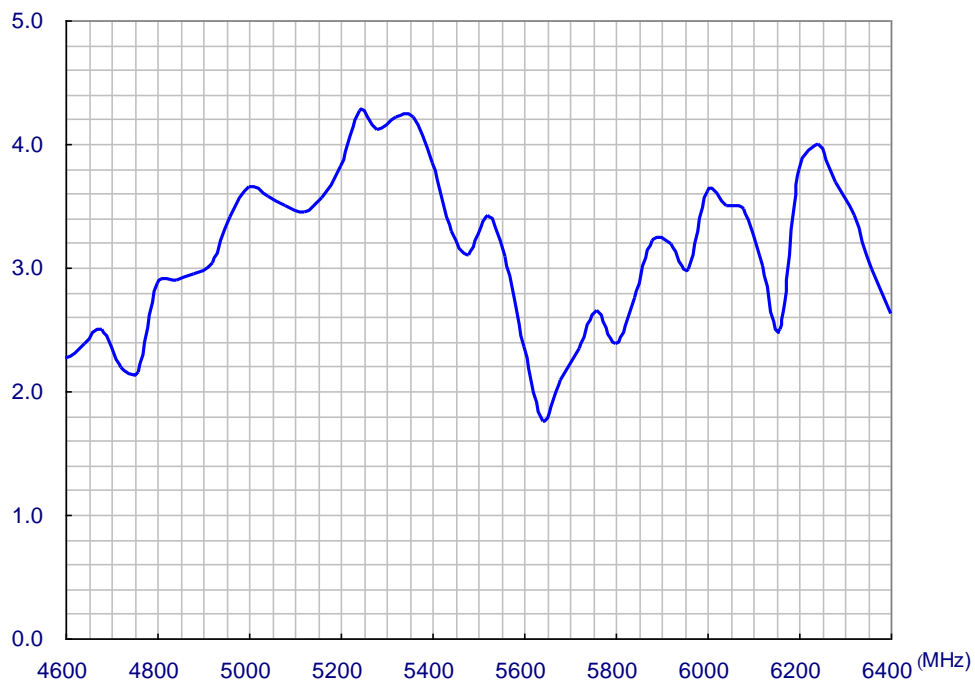
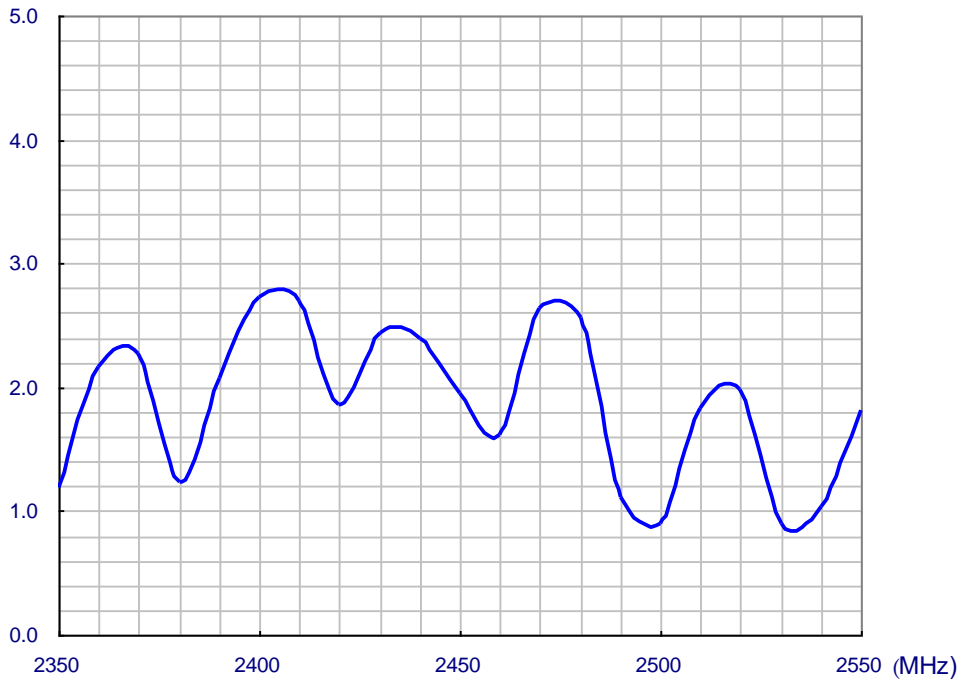

### 5.7. 2.4/5GHz Antenna Free Space 3D Average Gain (3m Cable)

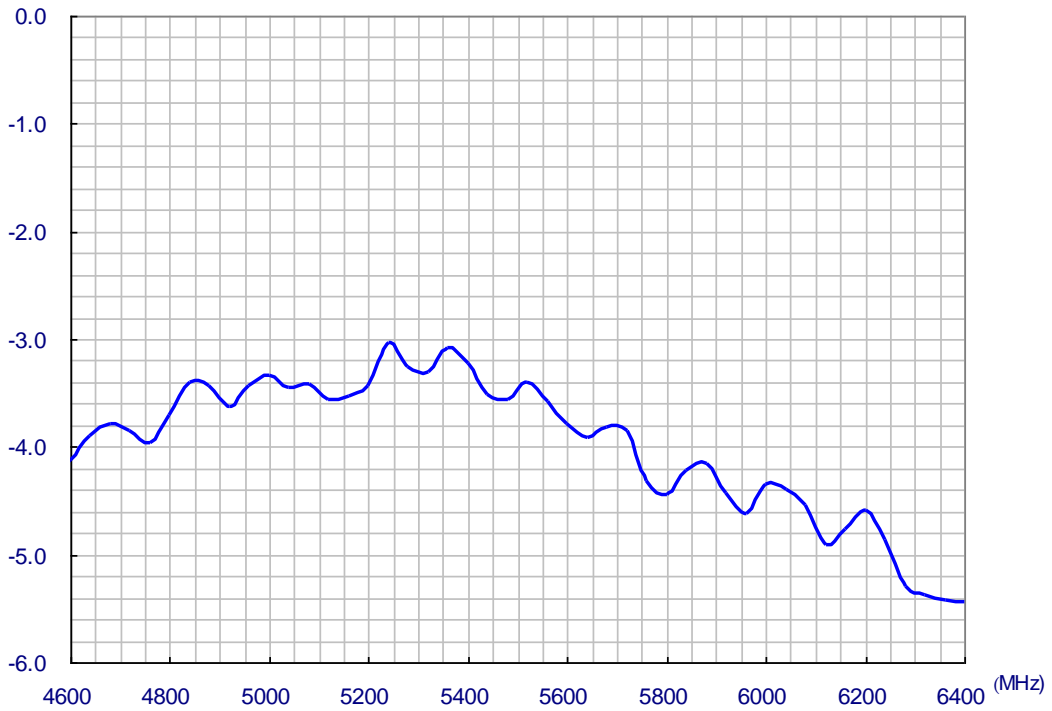
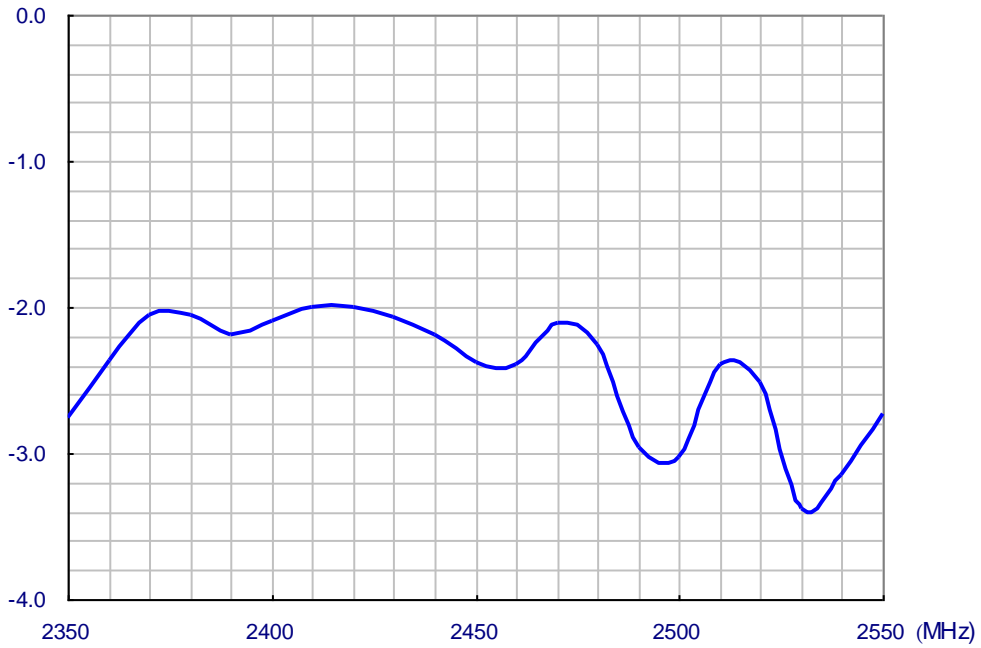

### 5.8. 2.4/5GHz Antenna Free Space Radiation (3m Cable)

XY Plane

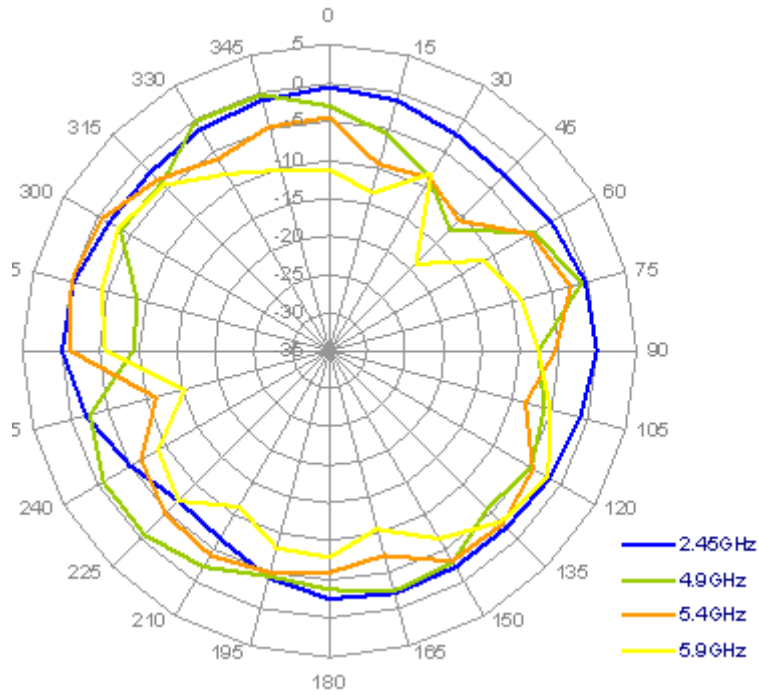

XZ Plane

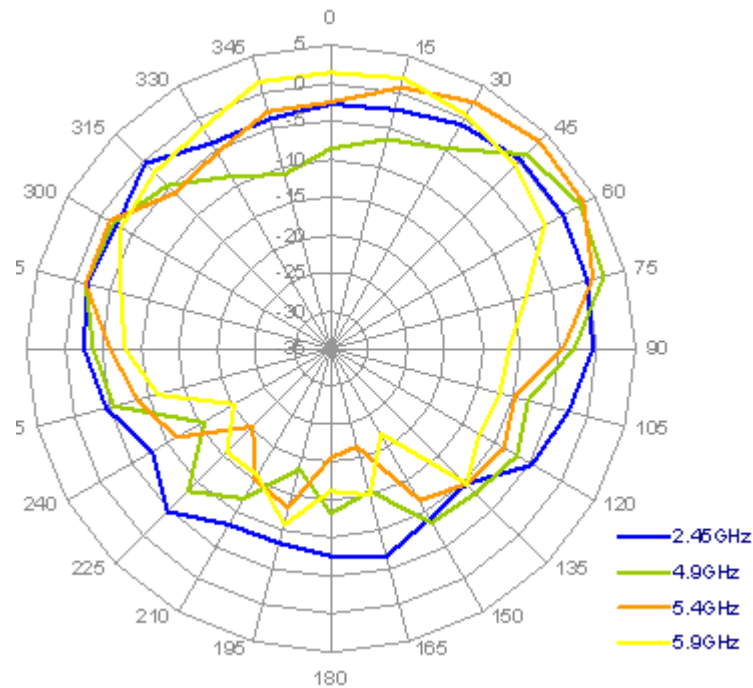

## 6. Installation

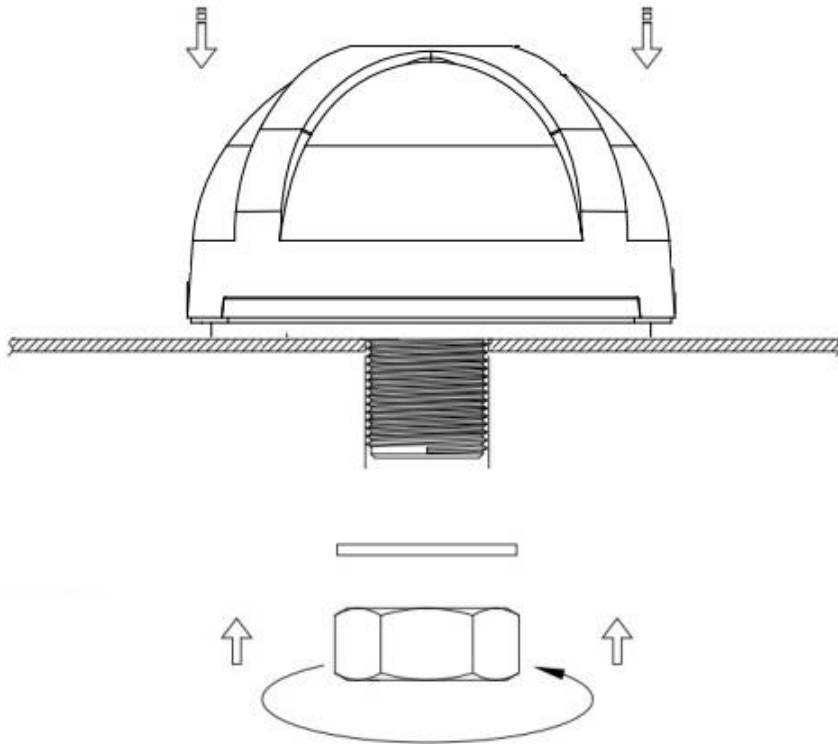

Recommended Torque for Mounting 49 N·m  
 Maximum Torque for Mounting 58.8 N·m

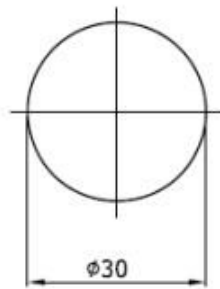

**Thread  
 Diameter**

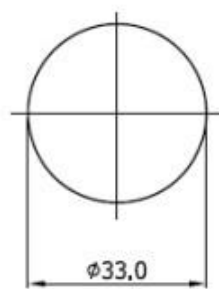

**Recommended  
 Mounting Hole**

**Unit: mm**

## 7. Mechanical Drawing

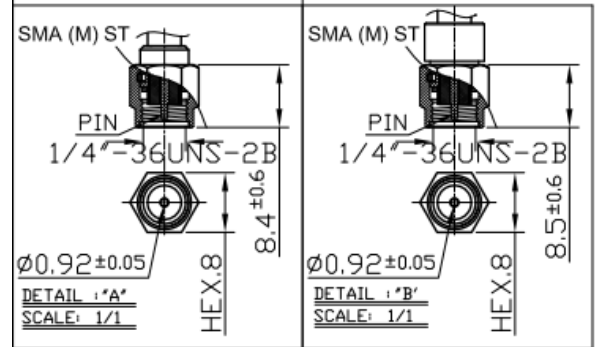
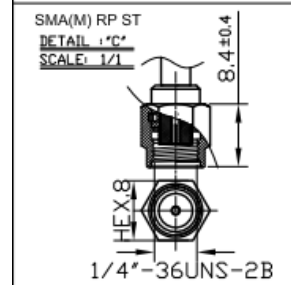
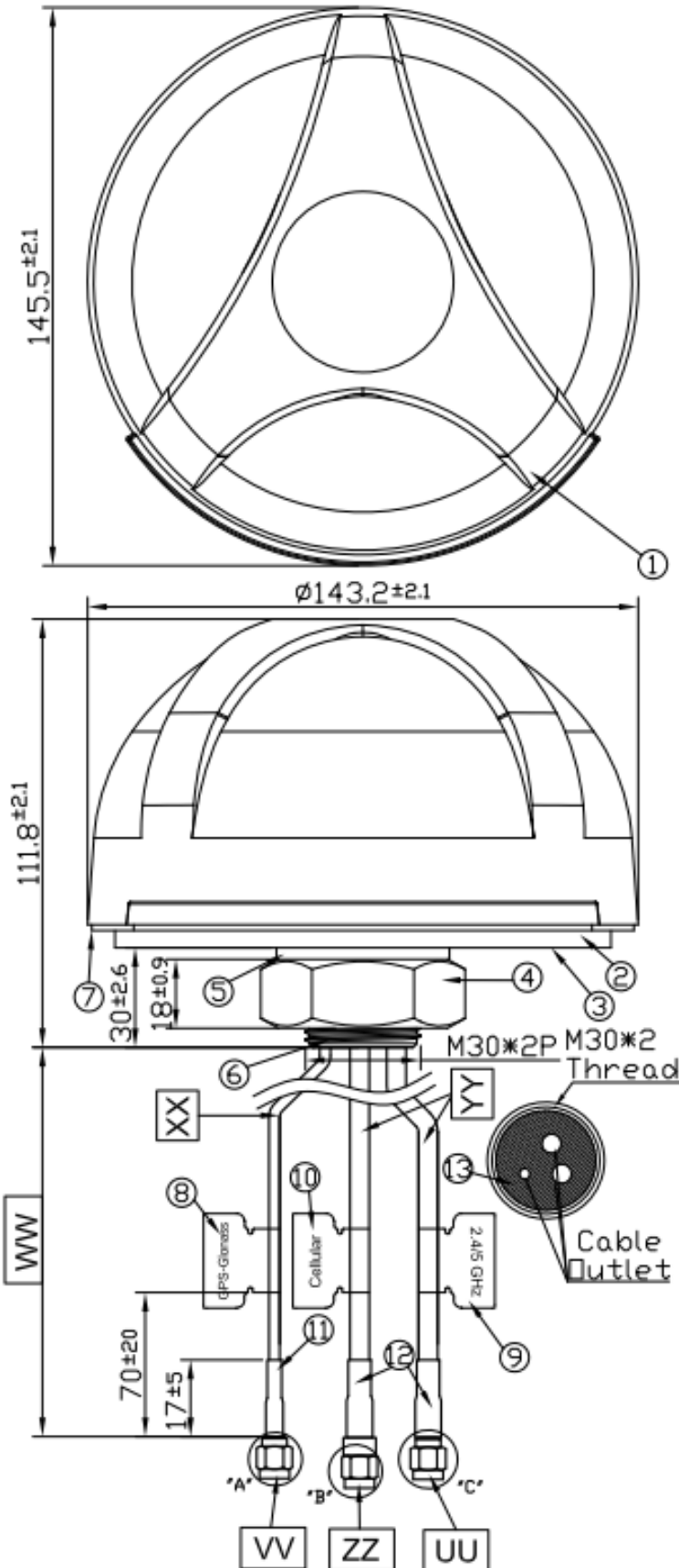

	Name	Material	Finish	QTY
1	Housing	PC 540	Black	1
2	Closed Cell Foam	CR 4305	Black	1
3	3M Double Adhesive	3M 9448 HK	White Liner	1
4	M30 Nut	Steel AISI 1215	Ni Plated	1
5	Washer	Steel AISI 1215	Ni Plated	1
6	M30x 2 Thread 32L	Zinc Alloy	Ni Plated	1
7	Waterproof Gasket	Silicon Rubber	Black	1
8	GPS-Glonass Label	Coated Paper	Orange	1
9	2.4GHz/5 GHz Label	Coated Paper	Green	1
10	Cellular Label	Coated Paper	Blue	1
11	Heat Shrink Tube	PE(RG174)	Black	1
12	Heat Shrink Tube	PE(CFD200)	Black	2
13	Rubber Stopper	Silicone Rubber	Black	1

	Name	Spec	Finish	QTY
VV	Connector Type	SMA(M) ST	Gold	1
UU	Connector Type	SMA(M)RP ST	Gold	1
WW	Cable Length	3000±120mm		3
XX	Cable Type	RG174	Black	1
YY	Cable Type	CFD 200	Black	2
ZZ	Connector Type	SMA(M) ST	Gold	1

## 8. Packaging

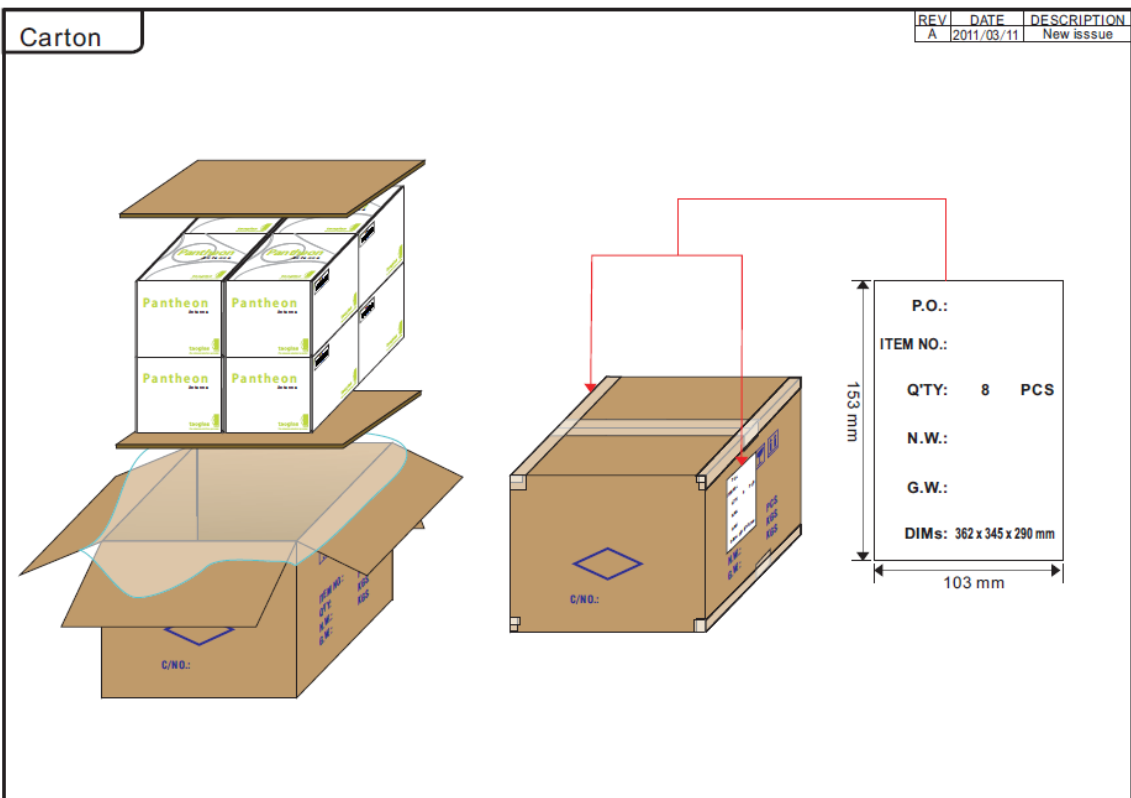
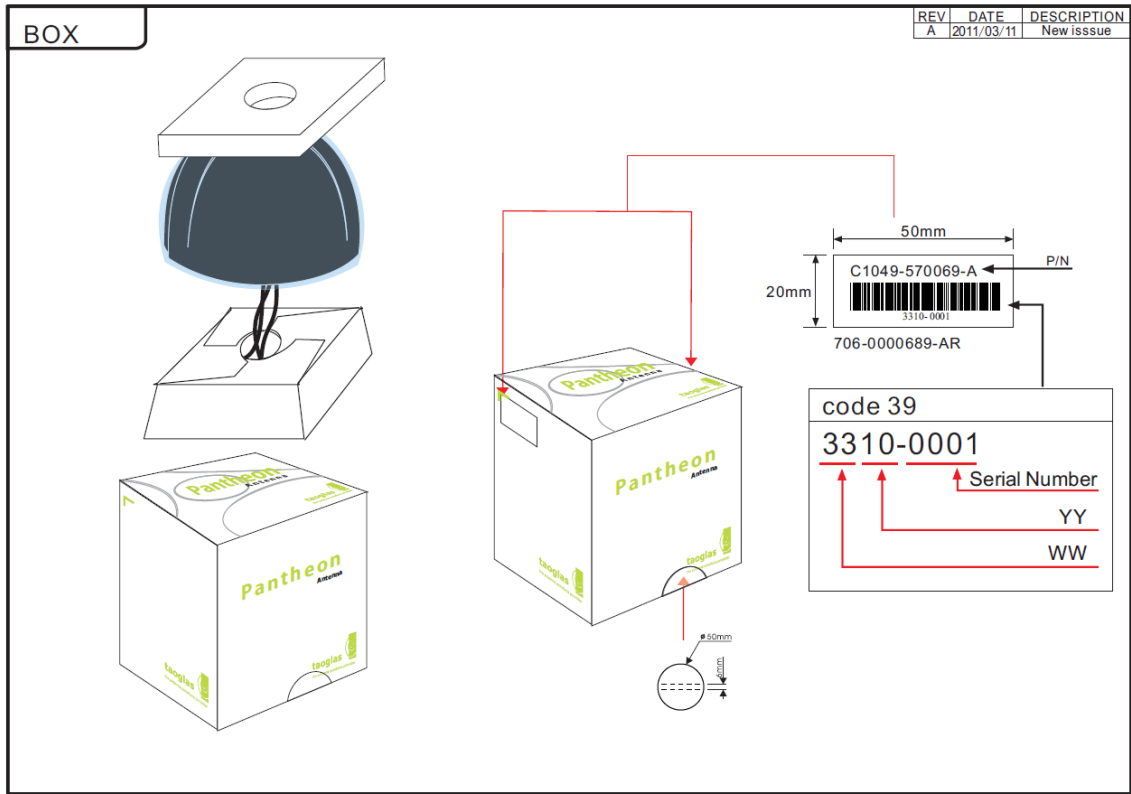



Taoglas makes no warranties based on the accuracy or completeness of the contents of this document and reserves the right to make changes to specifications and product descriptions at any time without notice. Taoglas reserves all rights to this document and the information contained herein.

Reproduction, use or disclosure to third parties without express permission is strictly prohibited.

Copyright © Taoglas Ltd.