

■ 外観図 Outline

- LEAD WIRE SIDE
- HSG : PHDR-08VS
- PIN : SPHD-001T-P0.5

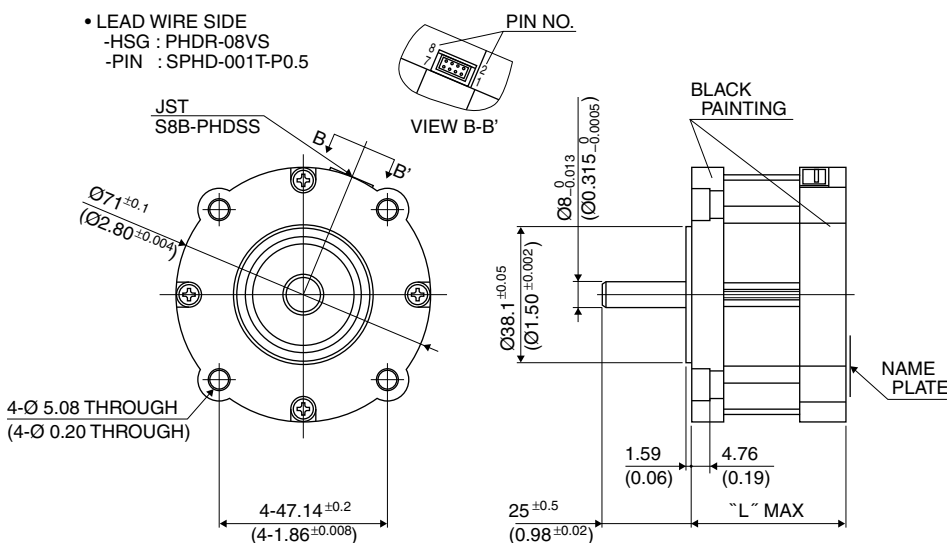

Hybrid

結線表 PIN NO. vs. PHASE

相 (PHASE)	A	A COM	\bar{A}	B	B COM	\bar{B}
ピン番号 (PIN NO.)	3	1	2	8	7	5

	"L"
29SM-K5**	39.5
29SM-K2**	43.5
29SM-K6**	46.5
29SM-K3**	51.5
29SM-K0**	55.5
29SM-K1**	67.5
29SM-K7**	77.5
29SM-K4**	87.5

■ 仕様 Specifications

型式	ステップ角	ドライブ方式	定格電流	巻線抵抗	ホールディングトルク	インダクタンス	ロータイナーシャ	ディテントトルク	質量
Model	Step Angle	Drive Sequence	Rated Current	Resistance	Holding Torque	Inductance	Rotor Inertia	Detent Torque	Mass
	(deg)		(A)	(Ohms)	(mNm)	(mH)	(g·cm ²)	(mNm)	(g)
29SM-K050U	1.8	UNI-POLAR	2.0	1.85	1236	3.7	390	37	900
29SM-K149U	1.8	UNI-POLAR	2.0	2.13	1569	4.7	515	49	1180
29SM-K250U	1.8	UNI-POLAR	1.6	2.0	672	3.3	220	22	660
29SM-K379U	1.8	UNI-POLAR	1.9	1.75	1000	3.1	330	32	820
29SM-K450U	1.8	UNI-POLAR	2.0	3.1	2550	7.8	770	74	1600
29SM-K550U	1.8	UNI-POLAR	1.5	2.1	500	3.1	165	12	570
29SM-K649U	1.8	UNI-POLAR	2.0	1.5	843	2.4	260	25	720
29SM-K711U	1.8	UNI-POLAR	3.0	1.0	1961	2.2	660	59	1390
29SM-K050B	1.8	BI-POLAR	2.8	0.97	1569	3.7	390	37	900
29SM-K149B	1.8	BI-POLAR	2.8	1.12	2079	4.7	515	49	1180
29SM-K250B	1.8	BI-POLAR	2.3	1.0	902	3.3	220	22	660
29SM-K379B	1.8	BI-POLAR	2.7	0.9	1373	3.1	330	32	820
29SM-K450B	1.8	BI-POLAR	2.8	1.6	3295	7.8	770	74	1600
29SM-K550B	1.8	BI-POLAR	2.1	1.1	667	3.1	165	12	570
29SM-K649B	1.8	BI-POLAR	2.8	0.75	1108	2.4	260	25	720
29SM-K711B	1.8	BI-POLAR	2.2	2.0	2550	8.5	660	59	1390

■ トルク・スピード特性 Torque/Speed Characteristics

Model No: 29SM-K050U
Driver: Chopper Dual
Supply Voltage: 24.0 (Volt)

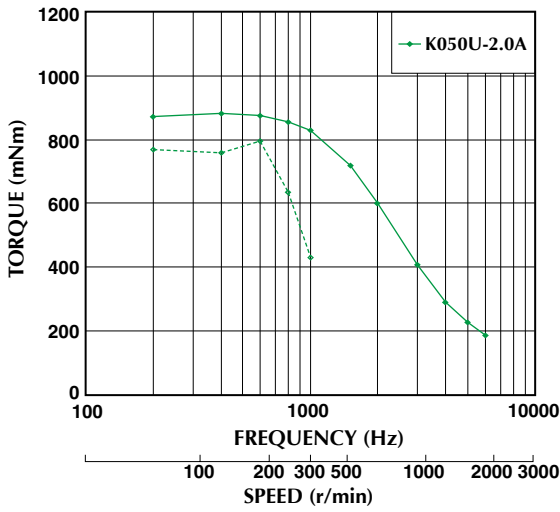

Model No: 29SM-K050B
Driver: Chopper Dual
Supply Voltage: 24.0 (Volt)

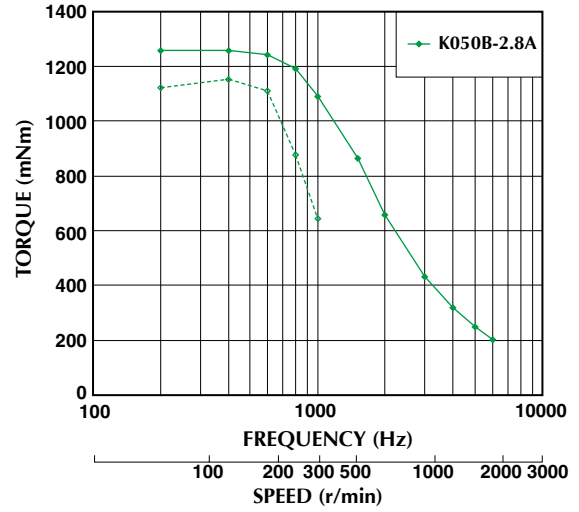

Model No: 29SM-K149U
Driver: Chopper Dual
Supply Voltage: 24.0 (Volt)

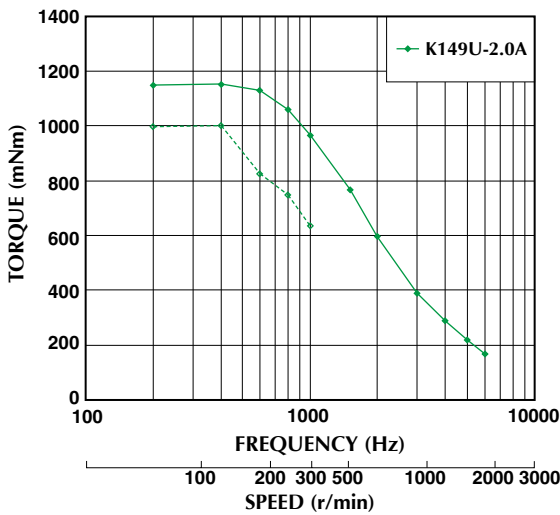

Model No: 29SM-K149B
Driver: Chopper Dual
Supply Voltage: 24.0 (Volt)

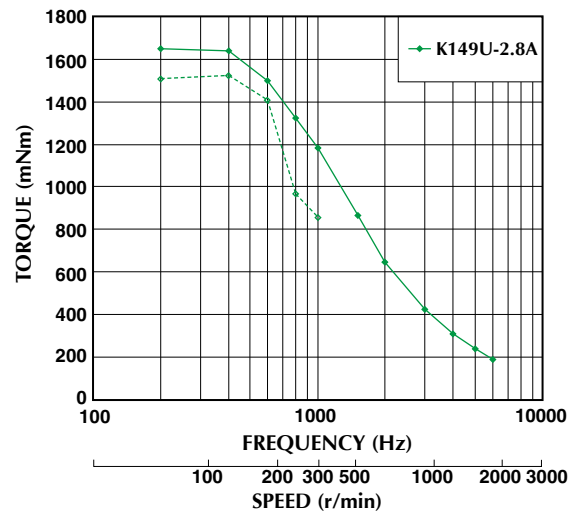

Model No: 29SM-K250U
Driver: Chopper Dual
Supply Voltage: 24.0 (Volt)

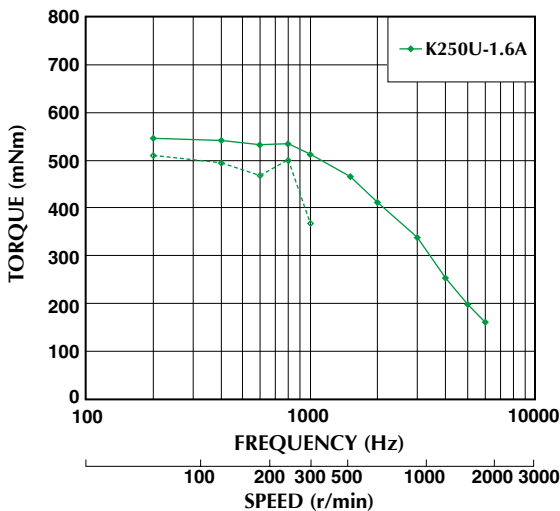

Model No: 29SM-K250B
Driver: Chopper Dual
Supply Voltage: 24.0 (Volt)

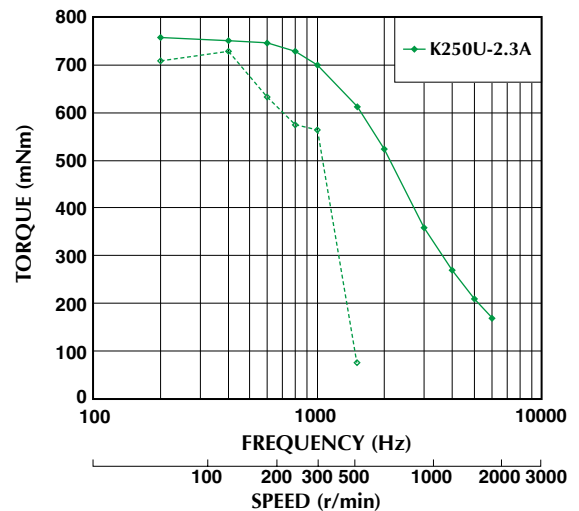

■ トルク特性は当社測定による参考データで、保証値ではありません。また、条件が変化すると、特性が変化する場合があります。
■ Torque/Speed characteristics are for reference only and it may change when operated at different drive conditions.

■ このカタログに掲載している製品の性能及び仕様は、改良の為予告なく変更することがありますのでご了承ください。
■ Specifications are subject to change without notice.

— : PULL OUT
- - - : PULL IN

■ トルク・スピード特性 Torque/Speed Characteristics

Model No: 29SM-K379U
Driver: Chopper Dual
Supply Voltage: 24.0 (Volt)

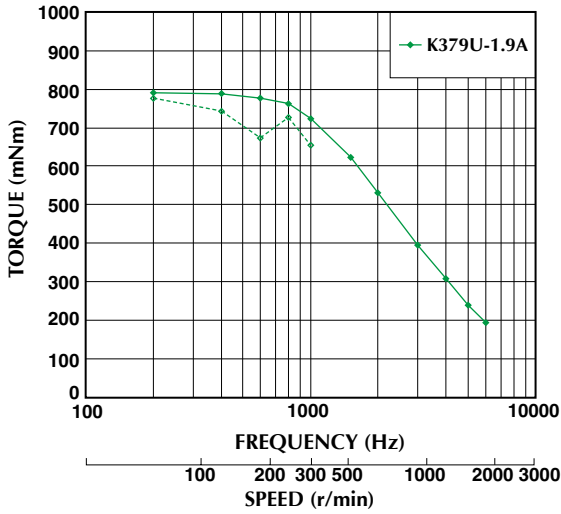

Model No: 29SM-K379B
Driver: Chopper Dual
Supply Voltage: 24.0 (Volt)

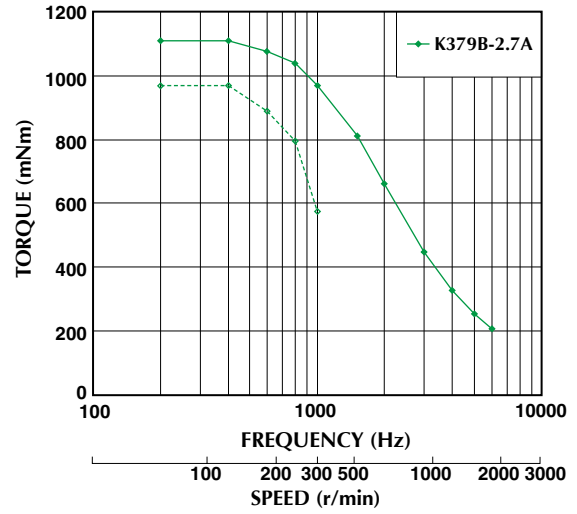

Model No: 29SM-K450U
Driver: Chopper Dual
Supply Voltage: 24.0 (Volt)

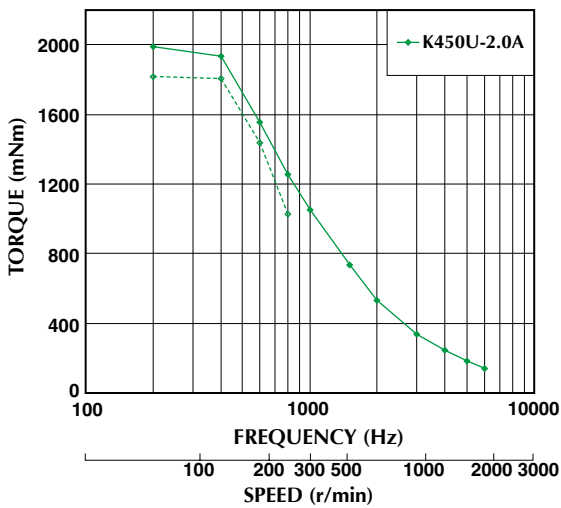

Model No: 29SM-K550B
Driver: Chopper Dual
Supply Voltage: 24.0 (Volt)

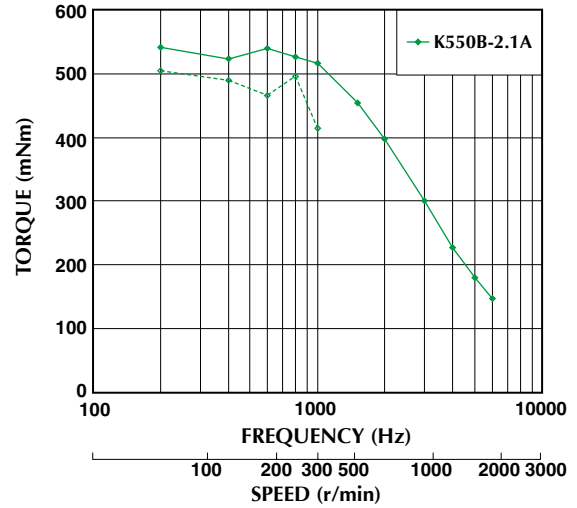

Model No: 29SM-K550U
Driver: Chopper Dual
Supply Voltage: 24.0 (Volt)

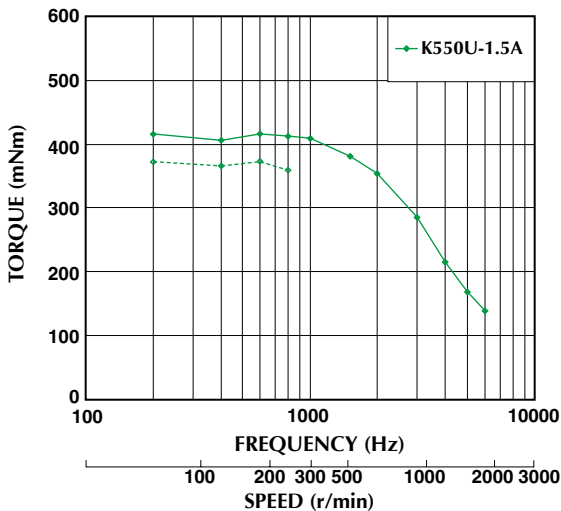

■ トルク特性は当社測定による参考データで、保証値ではありません。また、条件が変化すると、特性が変化する場合があります。
■ Torque/Speed characteristics are for reference only and it may change when operated at different drive conditions.

— : PULL OUT
- - - : PULL IN

■ トルク・スピード特性 Torque/Speed Characteristics

Model No: 29SM-K649U
Driver: Chopper Dual
Supply Voltage: 24.0 (Volt)

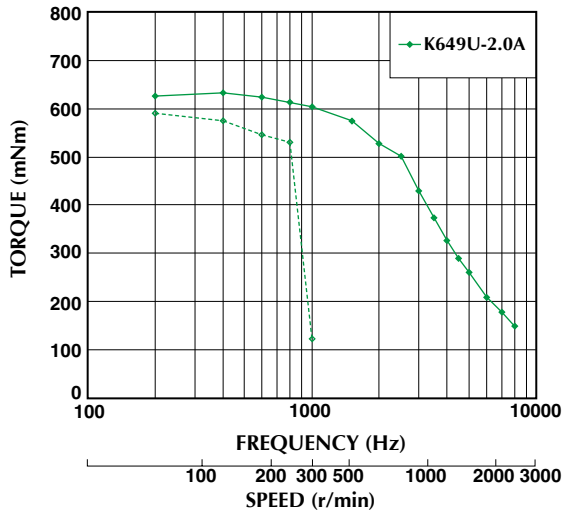

Model No: 29SM-K649B
Driver: Chopper Dual
Supply Voltage: 24.0 (Volt)

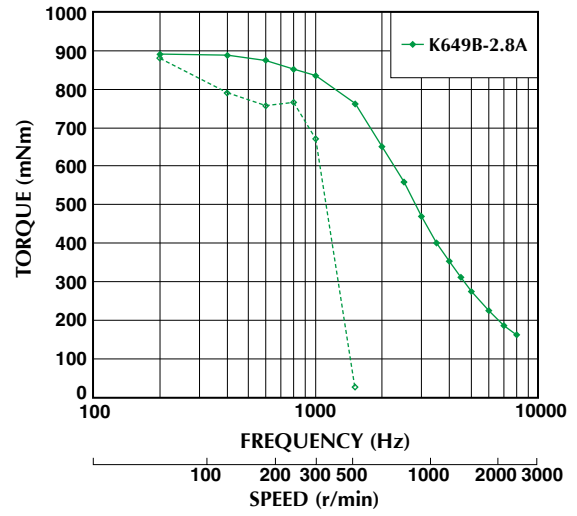

Model No: 29SM-K711U
Driver: Chopper Dual
Supply Voltage: 24.0 (Volt)

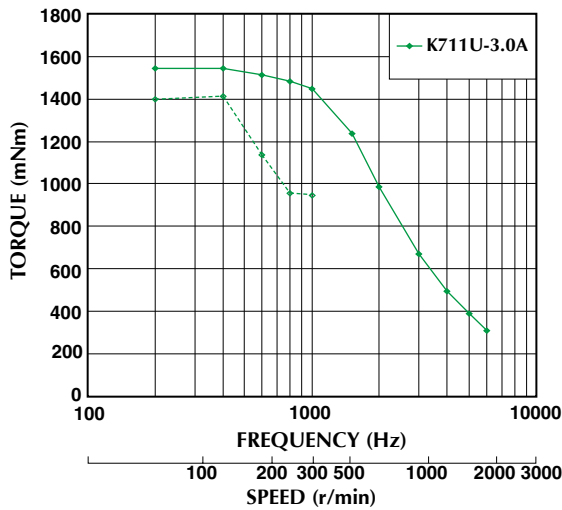

Model No: 29SM-K711B
Driver: Chopper Dual
Supply Voltage: 24.0 (Volt)

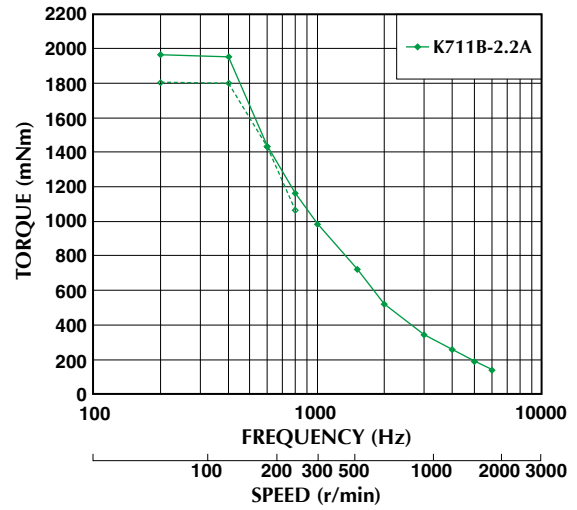

- トルク特性は当社測定による参考データで、保証値ではありません。また、条件が変化すると、特性が変化する場合があります。
- Torque/Speed characteristics are for reference only and it may change when operated at different drive conditions.
- このカタログに掲載している製品の性能及び仕様は、改良の為予告なく変更することがありますのでご了承ください。
- Specifications are subject to change without notice.

— : PULL OUT
- - - : PULL IN