

# Digital Temperature Controllers

## E5□Z

### 1/16, 1/8, and 1/4 DIN Temperature Controllers Join the Best-selling E5□Z Series

- Models available with either temperature inputs or analog inputs.
- A wide range of functions, such as a loop break alarm (LBA), manual output, and transfer output.
- Easy-to-read 11-segment display.
- Faster sampling at 250 ms.
- Setting Tool port provided as a standard feature for easy connection to personal computers.
- New protocol called Modbus is installed in the models with communications.

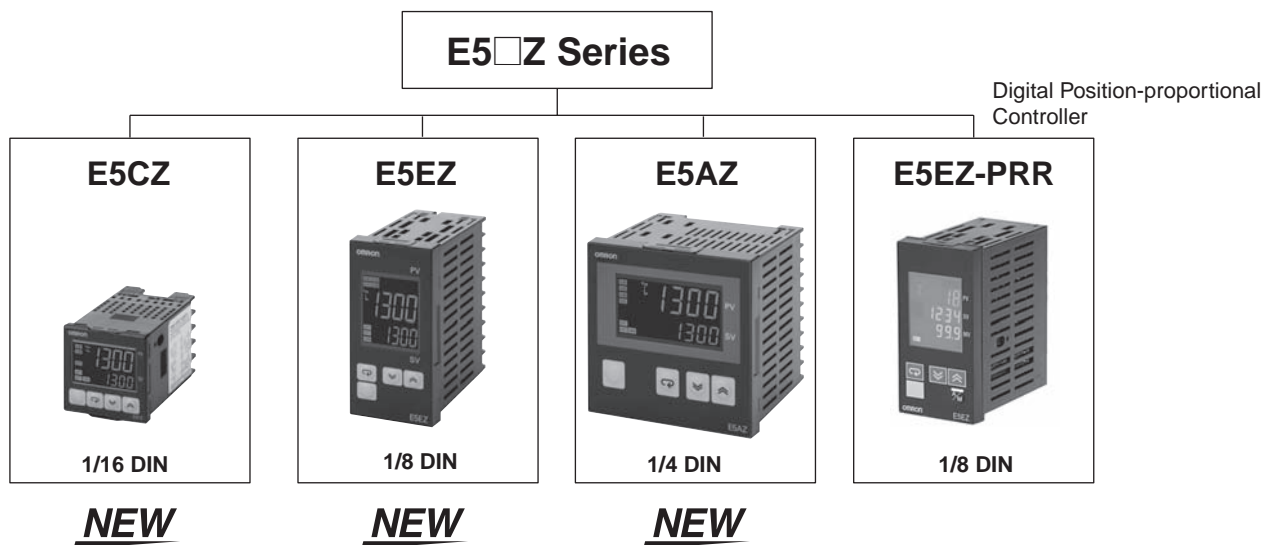

### Contents

<b>Digital Temperature Controllers</b>	
<b><u>NEW</u></b> E5CZ/E5CZ-U .....	2
<b><u>NEW</u></b> E5AZ/E5EZ .....	14
E5EZ-PRR .....	37
<b>Common to Updated E5□Z Controllers</b>	
• Operation .....	26
• Precautions .....	33
<b>E5EZ-PRR</b>	
• Operation .....	43
• Precautions .....	59

# Digital Temperature Controllers

## E5CZ/E5CZ-U (48 × 48 mm)

### This Best-selling General-purpose 48×48-mm Temperature Controller Is Now Even Better.

- Controllers now available with analog inputs.
- Faster sampling at 250 ms.
- Transfer output provided for easy output to recorders.
- Models available with a loop break alarm (LBA) and heater short alarm (HS alarm).
- Easy setting with 11-segment displays.
- Setting protection indicator informs operator when protection is enabled.
- Manual output provided.
- New protocol called Modbus is installed in the models with communications.
- USB-Serial conversion cable is available.

**Note:** Refer to Precautions on page 33.



48 × 48 mm  
E5CZ

48 × 48 mm  
E5CZ-U

**NEW**

**Note:** Refer to page 30 for information on changes in comparison to previous models.

## Main I/O Functions

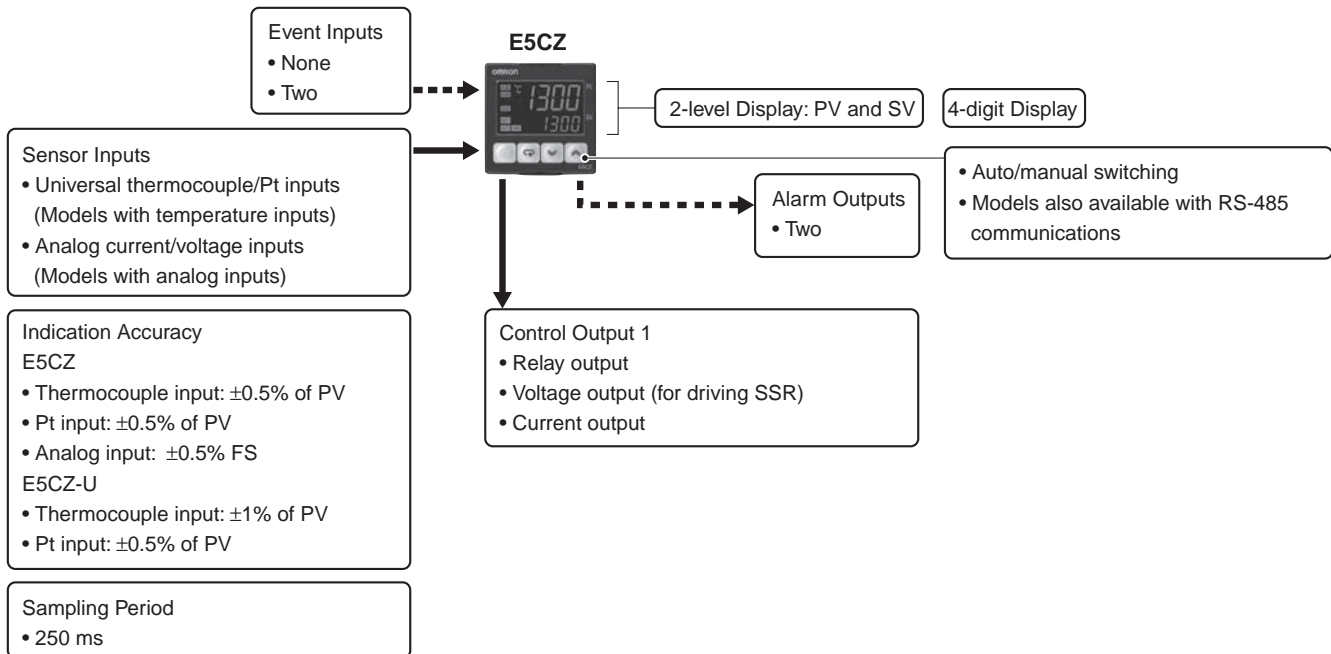

This data sheet is provided as a guideline for selecting products. Be sure to refer to the following user manuals for application precautions and other information required for operation before attempting to use the product.

E5CZ/E5CZ-U/E5AZ/E5EZ Digital Temperature Controllers User's Manual (Cat. No. H207)

E5CZ/E5CZ-U/E5AZ/E5EZ Digital Temperature Controllers Communications Manual (Cat. No. H208)

## Model Number Structure

### Model Number Legend

#### Controllers

E5CZ-□2M□□

1 2 3 4 5

#### 1. Control Output 1

- R: Relay output
- Q: Voltage output (for driving SSR)
- C: Current output

#### 2. Number of Alarms

- 2: Two alarms

#### 3. Option

- Blank: None
- M: Option Unit can be mounted.

#### 4. Input Type

- T: Thermocouple, infrared sensor/platinum resistance thermometer
- L: Analog current/voltage input

#### 5. Power Supply Voltage

- Blank: 100 to 240 VAC
- D: 24 VAC/VDC

#### Option Units

E53-CZ□□

1 2 3

#### 1. Applicable Controller

- CZ: E5CZ

#### 2. Function 1

- Blank: None
- H: Heater burnout/Heater short detection (CT1)

#### 3. Function 2

- B: Two event inputs
- 03: RS-485 communications

**Note:** Not all combinations of function 1 and function 2 specifications are possible for Option Units (E53-CZ□□).

## Ordering Information

### Controllers with Terminal Blocks

Size	Power supply voltage	Input type	Alarm output	Mounting option units	Control output	Previous model	New model
1/16 DIN 48 × 48 × 78 (W × H × D)	100 to 240 VAC	Thermocouple or Resistance thermometer	2	No	Relay output	E5CZ-R2	<b>E5CZ-R2T</b>
					Voltage output (for driving SSR)	E5CZ-Q2	<b>E5CZ-Q2T</b>
					Yes	Relay output	E5CZ-R2M
				Voltage output (for driving SSR)	E5CZ-Q2M	<b>E5CZ-Q2MT</b>	
				Current output	E5CZ-C2M	<b>E5CZ-C2MT</b>	
				Yes	Relay output	None	<b>E5CZ-R2ML</b>
	Voltage output (for driving SSR)	None	<b>E5CZ-Q2ML</b>				
	Current output	None	<b>E5CZ-C2ML</b>				
	Yes	Relay output	E5CZ-R2MD		<b>E5CZ-R2MTD</b>		
		Voltage output (for driving SSR)	E5CZ-Q2MD		<b>E5CZ-Q2MTD</b>		
		Current output	E5CZ-C2MD		<b>E5CZ-C2MTD</b>		
	24 VAC/VDC	Thermocouple or Resistance thermometer	2	Yes	Relay output	None	<b>E5CZ-R2MLD</b>
Voltage output (for driving SSR)					None	<b>E5CZ-Q2MLD</b>	
Current output					None	<b>E5CZ-C2MLD</b>	
Yes				Relay output	None	<b>E5CZ-R2MLD</b>	
				Voltage output (for driving SSR)	None	<b>E5CZ-Q2MLD</b>	
				Current output	None	<b>E5CZ-C2MLD</b>	

### Option Units

One of the following Option Units can be mounted to provide the E5CZ with additional functions.

Functions		Previous model	New model
Communications RS-485		E53-CN03N	<b>E53-CZ03</b>
Communications RS-485	Heater burnout	E53-CNH03N	<b>E53-CZH03</b>
	Event inputs	E53-CNBN	<b>E53-CZB</b>
	Heater burnout	E53-CNHBN	<b>E53-CZHB</b>

**Note:** Option Units cannot be used for plug-in models.

These Option Units are applicable only to models released after October 2008.

# E5CZ/E5CZ-U

## Model Number Structure

### Model Number Legend (Plug-in-type Controllers)

E5CZ-□2T□U  
1 2 3 4 5

#### 1. Output Type

- R: Relay
- Q: Voltage output (for driving SSR)

#### 2. Number of Alarms

- 2: Two alarms

#### 3. Input Type

- T: Thermocouple, infrared sensor/platinum resistance thermometer

#### 4. Power Supply Voltage

- Blank: 100 to 240 VAC
- D: 24 VAC/VDC

#### 5. Plug-in type

- U: Plug-in type

## Ordering Information (Plug-in-type Controllers)

### Plug-in-Type Controllers

Size	Power supply voltage	Input type	Alarm output	Control output	Previous model	New model
1/16 DIN	100 to 240 VAC	Thermocouple or Resistance thermometer	2	Relay output	None	E5CZ-R2TU
				Voltage output (for driving SSR)	None	E5CZ-Q2TU
	24 VAC/VDC	Thermocouple or Resistance thermometer	2	Relay output	None	E5CZ-R2TDU
				Voltage output (for driving SSR)	None	E5CZ-Q2TDU

## Accessories (Order Separately)

### USB-Serial Conversion Cable

Model
E58-CIFQ1

### Terminal Cover

Connectable models	Terminal block models
Model	E53-COV17

### Waterproof Packing

Model
Y92S-29

**Note:** The Waterproof Packing is included with the Controller only for models with terminal blocks.

### Current Transformers (CTs)

Hole diameter	Model
5.8 dia.	E54-CT1
12.0 dia.	E54-CT3

### Adapter

Connectable models	Model
Terminal block models	Y92F-45

**Note:** Use this Adapter when the panel has been previously prepared for the E5B□.

### Sockets (for Plug-in Models)

Type	Model
Front-connecting Socket	P2CF-11
Front-connecting Socket with Finger Protection	P2CF-11-E
Back-connecting Socket	P3GA-11
Terminal Cover for Back-connecting socket with Finger Protection	Y92A-48G

## Specifications

### Ratings

<b>Power supply voltage</b>		<b>100 to 240 VAC, 50/60 Hz</b>	<b>24 VAC, 50/60 Hz or 24 VDC</b>
<b>Operating voltage range</b>		85% to 110% of rated supply voltage	
<b>Power consumption</b>	<b>E5CZ</b>	7.5 VA	5.5 VA (24 VAC)/3.5 W (24 VDC)
	<b>E5CZ-U</b>	6 VA	4.5 VA (24 VAC)/2.5 W (24 VDC)
<b>Sensor input</b>		Models with temperature inputs Thermocouple: K, J, T, E, L, U, N, R, S, or B Platinum resistance thermometer: Pt100 or JPt100 Infrared temperature sensor: 10 to 70°C, 60 to 120°C, 115 to 165°C, or 140 to 260°C Voltage input: 0 to 50 mV	
		Models with analog inputs Current input: 4 to 20 mA or 0 to 20 mA Voltage input: 1 to 5 V, 0 to 5 V, or 0 to 10 V	
<b>Input impedance</b>		Current input: 150 Ω, Voltage input: 1 MΩ (Use a 1:1 connection when connecting the ES2-HB.)	
<b>Control output</b>	<b>Relay output</b>	E5CZ	SPST-NO, 250 VAC, 3 A (resistive load), electrical life: 100,000 operations, minimum applicable load: 5 V, 10 mA
		E5CZ-U	SPDT, 250 VAC, 3 A (resistive load), electrical life: 100,000 operations, minimum applicable load: 5 V, 10 mA
	<b>Voltage output (for driving SSR)</b>	E5CZ E5CZ-U	Output voltage: 12 VDC ±15% (PNP), max. load current: 21 mA, with short-circuit protection circuit
	<b>Current output</b>	E5CZ	4 to 20 mA DC/0 to 20 mA DC, load: 600 Ω max., resolution: approx. 2,700
<b>Alarm output</b>		SPST-NO, 250 VAC, 1 A (resistive load), electrical life: 100,000 operations, minimum applicable load: 5 V, 10 mA	
<b>Event input</b>	<b>Contact input</b>	ON: 1 kΩ max., OFF: 100 kΩ min.	
	<b>Non-contact input</b>	ON: Residual voltage: 1.5 V max., OFF: Leakage current: 0.1 mA max.	
		Outflow current: Approx. 7 mA per point	
<b>Control method</b>		ON/OFF control or 2-PID control (with auto-tuning)	
<b>Setting method</b>		Digital setting using front panel keys	
<b>Indication method</b>		11-segment digital display and individual indicators (7-segments displays also possible) Character height: PV: 11 mm, SV: 6.5 mm	
<b>Other functions</b>		Manual output, heating/cooling control, transfer output (on some models), loop break alarm, multi SP, MV limiter, input digital filter, self-tuning, temperature input shift, run/stop, protection functions, etc.	
<b>Ambient operating temperature</b>		-10 to 55°C (with no icing or condensation)	
<b>Ambient operating humidity</b>		25% to 85%	
<b>Storage temperature</b>		-25 to 65°C (with no icing or condensation)	

# E5CZ/E5CZ-U

## Input Ranges

### Thermocouples/Platinum Resistance Thermometers (Universal Inputs)

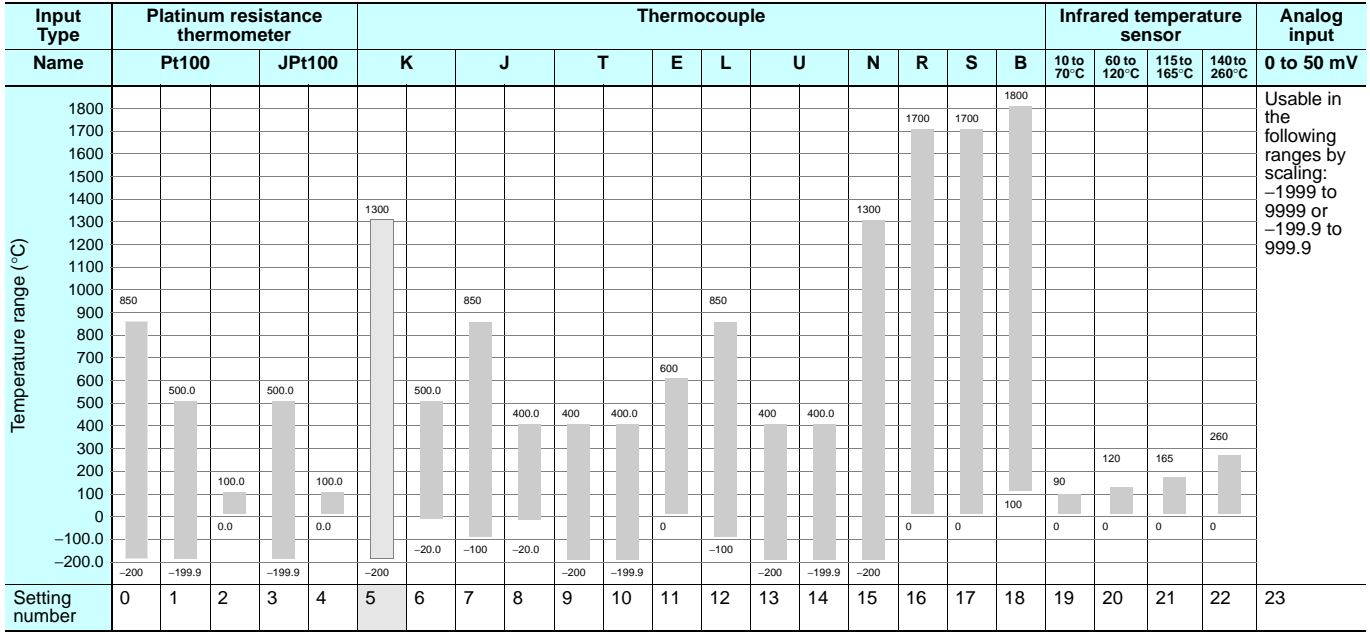

The applicable standards for the input types are as follows:

K, J, T, E, N, R, S, B: IEC584-1

L: Fe-CuNi, DIN 43710-1985

U: Cu-CuNi, DIN 43710-1985

Pt100: IEC 751

JPt100: JIS C 1604-1989, JIS C 1606-1989

Shaded settings are the default settings.

### Models with Analog Inputs

Input Type	Current		Voltage		
	Input specification	4 to 20mA	0 to 20 mA	1 to 5 V	0 to 5 V
Setting range	Usable in the following ranges by scaling: -1999 to 9999, -199.9 to 999.9, -19.99 to 99.99 or -1.999 to 9.999				
Setting number	0	1	2	3	4

Shaded settings are the default settings.

## Alarm Types

Select alarm types out of the 12 alarm types listed in the following table.

Set value	Alarm type	Alarm output operation	
		When X is positive	When X is negative
0	Alarm function OFF	Output OFF	
1 (See note 1.)	Upper- and lower-limit		(See note 2.)
2	Upper limit		
3	Lower limit		
4 (See note 1.)	Upper- and lower-limit range		(See note 3.)
5 (See note 1.)	Upper- and lower-limit with standby sequence		(See note 4.)
6	Upper-limit with standby sequence		
7	Lower-limit with standby sequence		
8	Absolute-value upper-limit		
9	Absolute-value lower-limit		
10	Absolute-value upper-limit with standby sequence		
11	Absolute-value lower-limit with standby sequence		
12 (See note 6.)	LBA (for alarm 1 type only)	---	

**Note: 1.** With set values 1, 4 and 5, the upper and lower limit values can be set independently for each alarm type, and are expressed as "L" and "H."

**2.** Set value: 1, Upper- and lower-limit alarm

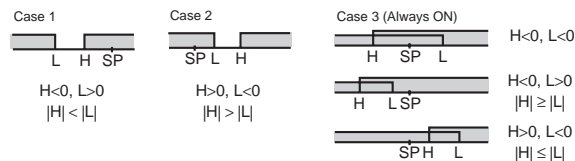

**3.** Set value: 4, Upper- and lower-limit range

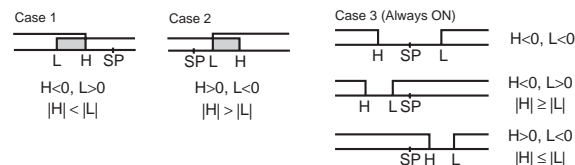

**4.** Set value: 5, Upper- and lower-limit with standby sequence  
For Upper- and Lower-Limit Alarm Described Above

- Case 1 and 2

Always OFF when the upper-limit and lower-limit hysteresis overlaps.

- Case 3: Always OFF

**5.** Set value: 5, Upper- and lower-limit with standby sequence  
Always OFF when the upper-limit and lower-limit hysteresis overlaps.

**6.** Set value: 12, LBA (loop break alarm) can be set only for alarm 1 type.

Set the alarm types for alarms 1 to 3 independently in the initial setting level. The default setting is 2 (upper limit).

## Characteristics

<b>Indication accuracy</b>	Thermocouple: (See note 1.) E5CZ: ( $\pm 0.5\%$ of indicated value or $\pm 1^\circ\text{C}$ , whichever is greater) $\pm 1$ digit max. E5CZ-U: ( $\pm 1\%$ of indicated value or $\pm 2^\circ\text{C}$ , whichever is greater) $\pm 1$ digit max. Platinum resistance thermometer: ( $\pm 0.5\%$ of indicated value or $\pm 1^\circ\text{C}$ , whichever is greater) $\pm 1$ digit max. Analog input: $\pm 0.5\%$ FS $\pm 1$ digit max. CT input: $\pm 5\%$ FS $\pm 1$ digit max.
<b>Influence of temperature (See note 2.)</b>	R, S, and B thermocouple inputs: ( $\pm 1\%$ of PV or $\pm 10^\circ\text{C}$ , whichever is greater) $\pm 1$ digit max. Other thermocouple inputs: ( $\pm 1\%$ of PV or $\pm 4^\circ\text{C}$ , whichever is greater) $\pm 1$ digit max. $\pm 10^\circ\text{C}$ for $-100^\circ\text{C}$ or less for K sensors Platinum resistance thermometer inputs: ( $\pm 1\%$ of PV or $\pm 2^\circ\text{C}$ , whichever is greater) $\pm 1$ digit max. Analog inputs: ( $\pm 1\%$ of FS) $\pm 1$ digit max.
<b>Influence of voltage (See note 2.)</b>	
<b>Hysteresis</b>	Models with thermocouple/platinum resistance thermometer input (universal input): 0.1 to 999.9 EU (in units of 0.1 EU) Models with analog input: 0.01 to 99.99% FS (in units of 0.01% FS)
<b>Proportional band (P)</b>	Models with thermocouple/platinum resistance thermometer input (universal input): 0.1 to 999.9 EU (in units of 0.1 EU) Models with analog input: 0.1 to 999.9% FS (in units of 0.1% FS)
<b>Integral time (I)</b>	0 to 3999 s (in units of 1 s)
<b>Derivative time (D)</b>	0 to 3999 s (in units of 1 s)
<b>Control period</b>	0.5, 1 to 99 s (in units of 1 s)
<b>Manual reset value</b>	0.0 to 100.0% (in units of 0.1%)
<b>Alarm setting range</b>	-1999 to 9999 (decimal point position depends on input type)
<b>Sampling period</b>	250 ms
<b>Affect of signal source resistance</b>	Thermocouple: $0.1^\circ\text{C}/\Omega$ max. (100 $\Omega$ max.) (See note 3.) Platinum resistance thermometer: $0.4^\circ\text{C}/\Omega$ max. (10 $\Omega$ max.)
<b>Insulation resistance</b>	20 M $\Omega$ min. (at 500 VDC)
<b>Dielectric strength</b>	2,000 VAC, 50 or 60 Hz for 1 min (between terminals with different charge)
<b>Vibration resistance</b>	<b>Malfunction</b>
	<b>Destruction</b>
<b>Shock resistance</b>	<b>Malfunction</b>
	<b>Destruction</b>
<b>Weight</b>	<b>E5CZ</b>
	<b>E5CZ-U</b>
<b>Degree of protection</b>	<b>E5CZ</b>
	<b>E5CZ-U</b>
<b>Memory protection</b>	Non-volatile memory (number of writes: 1,000,000 times)
<b>EMC</b>	Emission Enclosure: EN55011 Group1 Class A Emission AC Mains: EN55011 Group1 Class A Immunity ESD: EN61000-4-2 4 kV contact discharge (level 2) 8 kV air discharge (level 3) Immunity RF-interference: EN61000-4-3 10 V/m (80-1000 MHz, 1.4-2.0 GHz amplitude modulated) (level 3) 10 V/m (900 MHz pulse modulated) Immunity Conducted Disturbance: EN61000-4-6 3 V (0.15 to 80 MHz) (level 2) Immunity Burst: EN61000-4-4 2 kV Power-line (level 3) 1 kV I/O signal-line (level 3) Immunity Surge: EN61000-4-5 1kV line to line Power line, output line (relay output) 2 kV line to ground Power line, output line (relay output) 1 kV line to ground Input line (communication) Immunity Voltage Dip/Interrupting: EN61000-4-11 0.5 cycle, 100% (rated voltage)
<b>Approved standards</b>	UL 61010C-1 CSA C22.2 No.1010.1
<b>Conformed standards</b>	EN61326, EN61010-1, IEC61010-1 VDE0106 Part 100 (Finger protection), when the terminal cover is mounted.

- Note:**
- The indication accuracy of K thermocouples in the  $-200$  to  $1300^\circ\text{C}$  range, T and N thermocouples at a temperature of  $-100^\circ\text{C}$  max., and U and L thermocouples at any temperature is  $\pm 2^\circ\text{C} \pm 1$  digit maximum. The indication accuracy of the B thermocouple at a temperature of  $400^\circ\text{C}$  max. is not specified. The indication accuracy of the R and S thermocouples at a temperature of  $200^\circ\text{C}$  max. is  $\pm 3^\circ\text{C} \pm 1$  digit max.
  - "EU" stands for Engineering Unit and is used as the unit after scaling. For a temperature sensor, the EU is  $^\circ\text{C}$  or  $^\circ\text{F}$ .
  - B, R, and S sensors:  $0.2^\circ\text{C}/\Omega$  max. (100  $\Omega$  max.)
  - There is no waterproof function for the E5CZ-U.

## USB-Serial Conversion Cable

<b>Applicable OS</b>	Windows 2000/XP/Vista
<b>Applicable software</b>	Thermo Mini
<b>Applicable models</b>	E5CZ/E5CZ-U/E5AZ/E5EZ
<b>USB interface standard</b>	Conforms to USB Specification 1.1.
<b>DTE speed</b>	38400 bps
<b>Connector specifications</b>	Computer: USB (type A plug) Temperature Controller: Setup Tool port (on bottom of Controller)
<b>Power supply</b>	Bus power (Supplied from USB host controller.)
<b>Power supply voltage</b>	5 VDC
<b>Current consumption</b>	70 mA
<b>Ambient operating temperature</b>	0 to $55^\circ\text{C}$ (with no condensation or icing)
<b>Ambient operating humidity</b>	10% to 80%
<b>Storage temperature</b>	$-20$ to $60^\circ\text{C}$ (with no condensation or icing)
<b>Storage humidity</b>	10% to 80%
<b>Altitude</b>	2,000 m max.
<b>Weight</b>	Approx. 100 g

**Note:** A driver must be installed in the personal computer. Refer to installation information in the operation manual for the Conversion Cable.

## Communications Specifications

<b>Transmission line connection method</b>	RS-485 multipoint
<b>Communications</b>	RS-485 (two-wire, half duplex)
<b>Synchronization method</b>	Start-stop synchronization
<b>Baud rate</b>	1200, 2400, 4800, 9600, 19200, or 38400 bps
<b>Transmission code</b>	ASCII
<b>Data length</b>	7 or 8 bits
<b>Stop bits</b>	1 or 2 bits
<b>Error detection</b>	Vertical parity (none, even, odd) Frame check sequence (FCS) with SYSWAY Block check character (BCC) with CompoWay/F or CRC-16 Modbus
<b>Flow control</b>	None
<b>Interface</b>	RS-485
<b>Retry function</b>	None
<b>Communications buffer</b>	40 bytes
<b>Send data wait time</b>	0 to 99 ms Default: 20 ms

**Note:** The baud rate, data length, stop bits, and vertical parity can be individually set using the Communications Setting Level.



### Current Transformer (Order Separately)

#### Ratings

Dielectric strength	1,000 VAC for 1 min
Vibration resistance	50 Hz, 98 m/s <sup>2</sup>
Weight	E54-CT1: Approx. 11.5 g, E54-CT3: Approx. 50 g
Accessories (E54-CT3 only)	Armatures (2) Plugs (2)

#### Heater Burnout and Heater Short Alarms

Maximum heater current	50 A AC
Input current indication accuracy	±5% FS ±1 digit max.
Heater burnout alarm setting range	0.1 to 49.9 A (in units of 0.1 A) 0.0 A: Heater burnout/Heater short alarm output turns OFF. 50.0 A: Heater burnout/Heater short alarm output turns ON. Minimum detection ON time: 190 ms (See note 1.)
Heater short alarm setting range	0.1 to 49.9 A (in units of 0.1 A) 0.0 A: Heater burnout/Heater short alarm output turns ON. 50.0 A: Heater burnout/Heater short alarm output turns OFF. Minimum detection OFF time: 190 ms (See note 2.)

- Note:** 1. If the ON time of control output 1 is less than 190 ms, heater burnout and the heater current will not be measured.  
2. If the OFF time of control output 1 is less than 190 ms, heater short alarm and the heater current will not be measured.

#### Electrical Life Expectancy Curve for Relays (Reference Values)

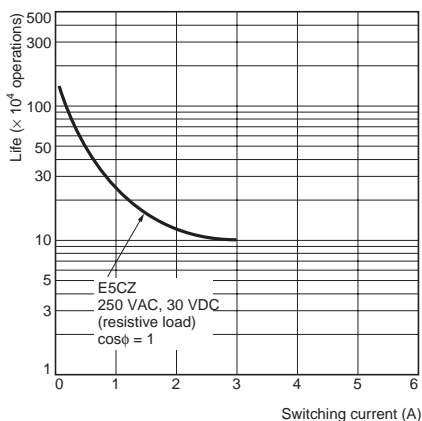

#### E54-CT1

#### Thru-current ( $I_o$ ) vs. Output Voltage ( $E_o$ ) (Reference Values)

Maximum continuous heater current: 50 A (50/60 Hz)  
Number of windings: 400±2  
Winding resistance: 18±2 Ω

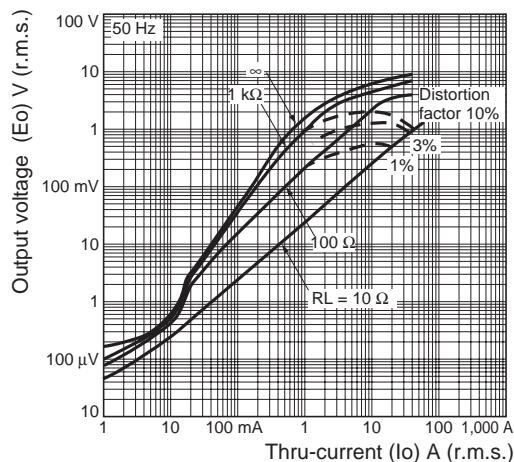

#### E54-CT3

#### Thru-current ( $I_o$ ) vs. Output Voltage ( $E_o$ ) (Reference Values)

Maximum continuous heater current: 120 A (50/60 Hz)  
(Maximum continuous heater current for an OMRON Temperature Controller is 50 A.)  
Number of windings: 400±2  
Winding resistance: 8±0.8 Ω

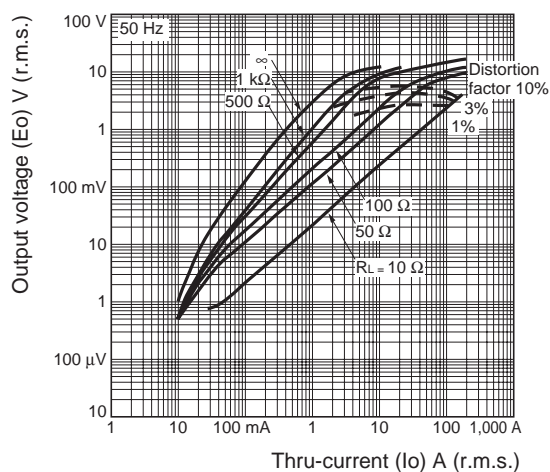

# E5CZ/E5CZ-U

## External Connections

- A voltage output (control output 1) is not electrically insulated from the internal circuits. When using a grounding thermocouple, do not connect any of the control output terminals to ground. If the control output terminals are connected to ground, errors will occur in the measured temperature values as a result of leakage current.

### E5CZ

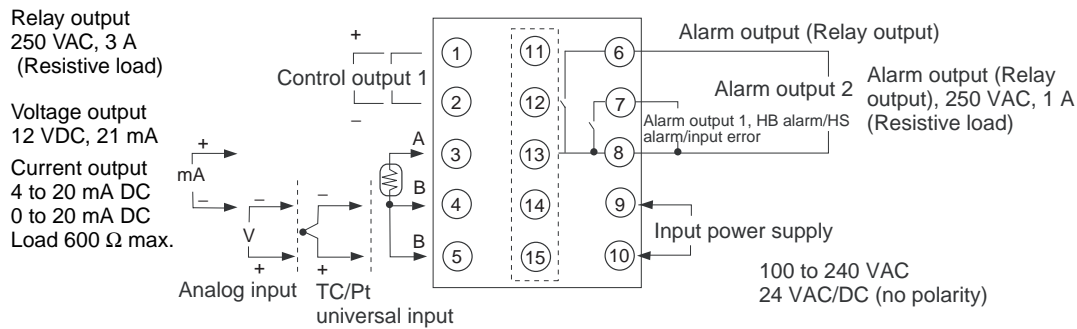

### Option Units

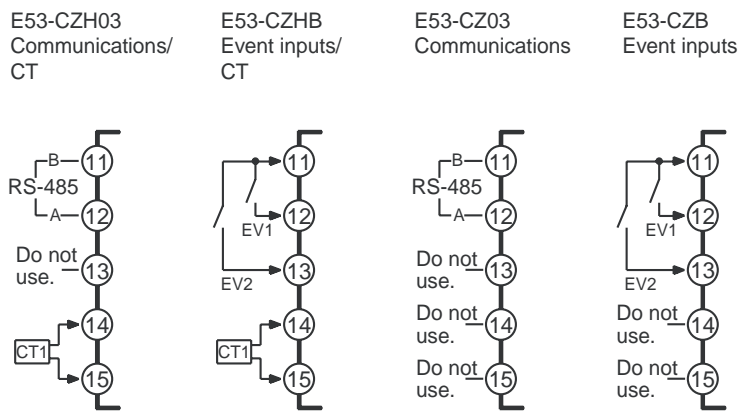

### E5CZ-U

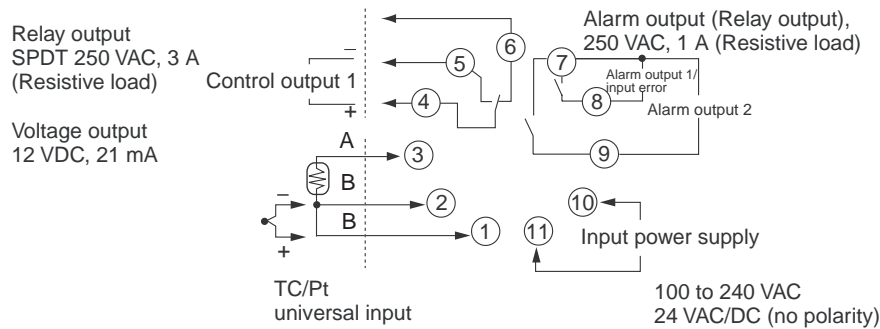

**Note:** For the Wiring Socket, purchase the P2CF-11 or PG3A-11 separately.

# Nomenclature

## E5CZ E5CZ-U

The front panel is the same for the E5CZ and E5CZ-U.

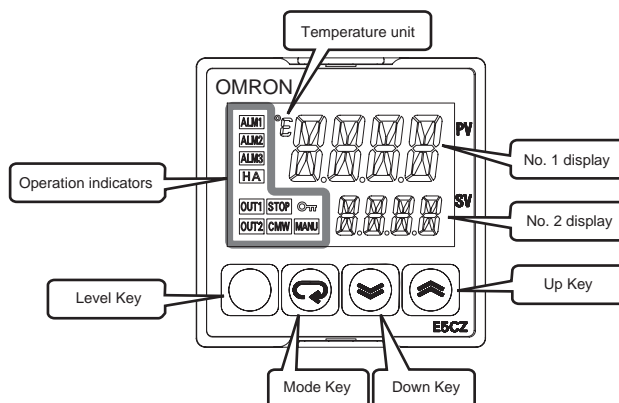

# Dimensions

## E5CZ Terminal Models

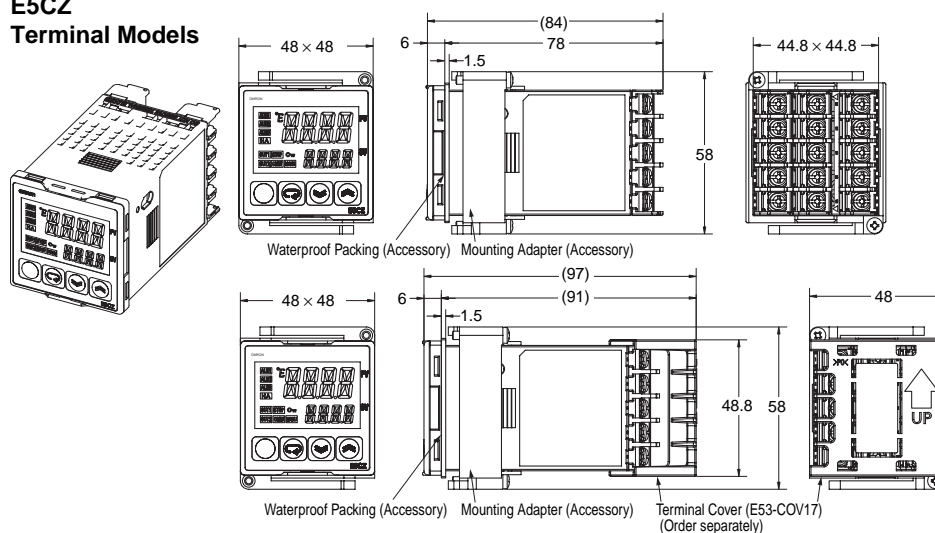

**Note:** The terminal block cannot be removed.

### Panel Cutout

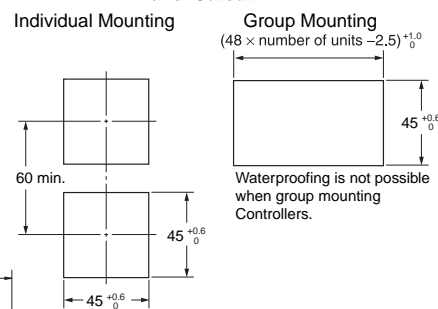

- Recommended panel thickness is 1 to 5 mm.
- Group mounting is not possible in the vertical direction. (Maintain the specified mounting space between Controllers.)
- To mount the Controller so that it is waterproof, insert the waterproof packing onto the Controller.
- When two or more Controllers are mounted, make sure that the surrounding temperature does not exceed the ambient operating temperature given in the specifications.

## E5CZ-U Plug-in Models

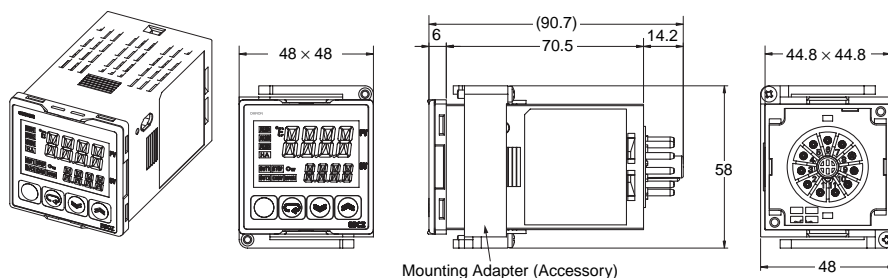

**Note:** There is no waterproof function for the E5CZ-U.

### Panel Cutout

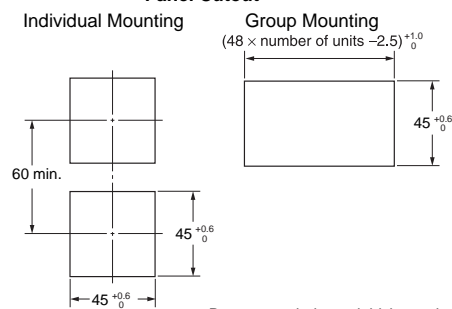

- Recommended panel thickness is 1 to 5 mm.
- Group mounting is not possible in the vertical direction. (Maintain the specified mounting space between Controllers.)
- When two or more Controllers are mounted, make sure that the surrounding temperature does not exceed the ambient operating temperature given in the specifications.

# E5CZ/E5CZ-U

## Accessories

### USB-Serial Conversion Cable (Order Separately)

E58-CIFQ1

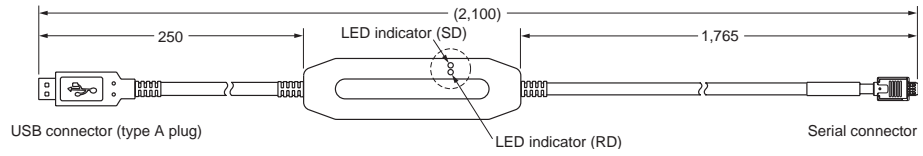
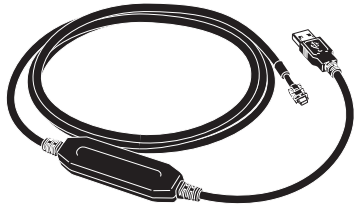

### Terminal Cover (Order Separately)

E53-COV17

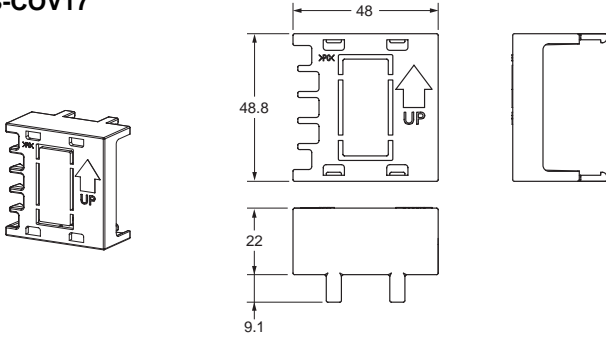

**Note:** The E53-COV10 cannot be used.

### Waterproof Packing

Y92S-29 (for DIN 48 × 48)

Order the Waterproof Packing separately if it becomes lost or damaged.

The Waterproof Packing can be used to achieve an IP66 (indoor use) degree of protection.

(Deterioration, shrinking, or hardening of the waterproof packing may occur depending on the operating environment. Therefore, periodic replacement is recommended to ensure the level of waterproofing specified in IP66 (indoor use). The time for periodic replacement depends on the operating environment. Be sure to confirm this point at your site. Consider one year a rough standard. OMRON shall not be liable for the level of water resistance if the customer does not perform periodic replacement.)

The Waterproof Packing does not need to be attached if a waterproof structure is not required.

**Note:** There is no waterproof function for the E5CZ-U.

### Unit Labels (Order Separately)

Y92S-L1 Type

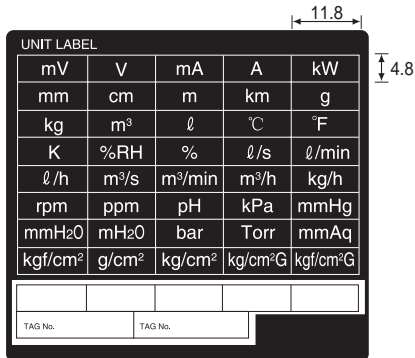

### Current Transformers (Order Separately)

E54-CT1

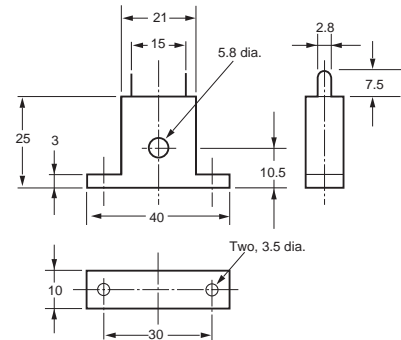
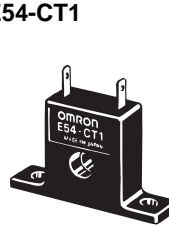

E54-CT3

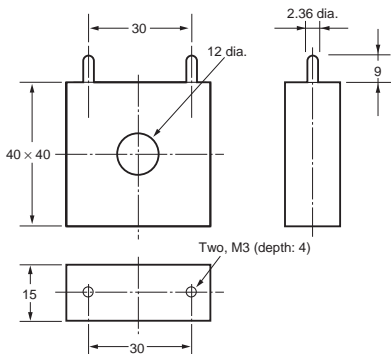

### E54-CT3 Accessory

#### • Armature

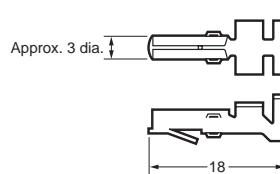

#### • Plug

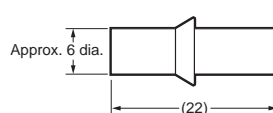

### Connection Example

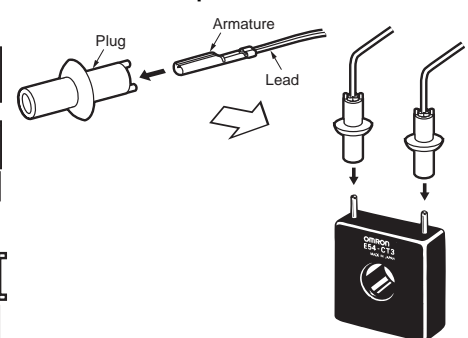

**Adapter (Order Separately)**

- Note:** 1. Use this Adapter when the panel has already been prepared for the E5B□.  
 2. Only black is available.

**Y92F-45**

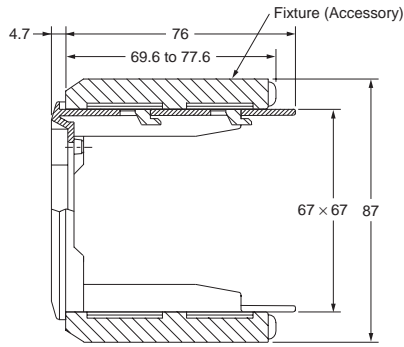
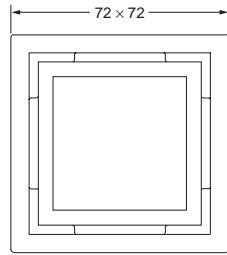
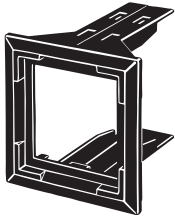

**Mounted to E5CZ**

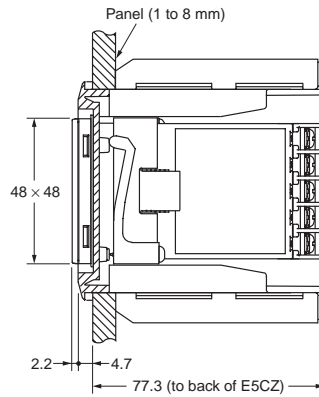
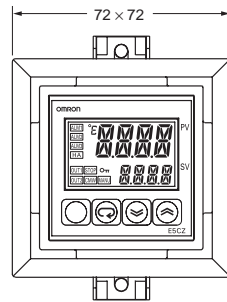
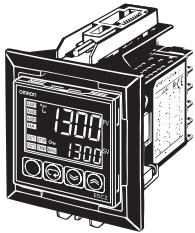

**E5CZ-U Wiring Socket (Order Separately)**

**Front-connecting Socket**

**P2CF-11**

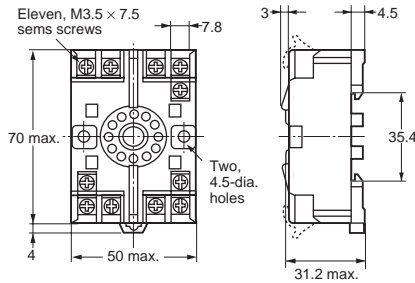
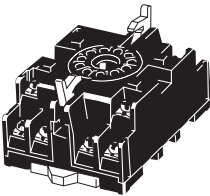

**Terminal Layout/Internal Connections (Top View)**

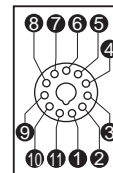

**Mounting Holes**

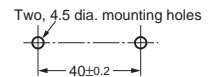

**Note:** Can also be mounted to a DIN track.

**Note:** A model with finger protection (P2CF-11-E) is also available.

**Back-connecting Socket**

**P3GA-11**

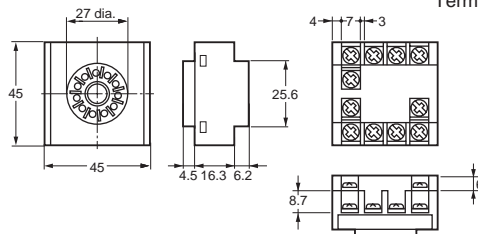
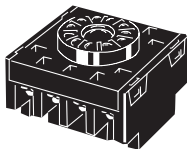

**Terminal Layout/Internal Connections (Bottom View)**

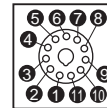

- Note:** 1. Using any other sockets will adversely affect accuracy. Use only the specified sockets.  
 2. A Protective Cover for finger protection (Y92A-48G) is also available.

## These Best-selling General-purpose Temperature Controllers Are Now Even Better.

- Controllers now available with analog inputs.
- Faster sampling at 250 ms.
- Transfer output provided for easy output to recorders.
- Models available with a loop break alarm (LBA) and heater short alarm (HS alarm).
- Manual output provided.
- Easy setting with 11-segment displays.
- New protocol called Modbus is installed in the models with communications.
- USB-Serial conversion cable is available.

**Note:** Refer to Precautions on page 33.



96 × 96 mm  
E5AZ



48 × 96 mm  
E5EZ

**NEW**

**Note:** Refer to page 30 for information on changes in comparison to previous models.

## Main I/O Functions

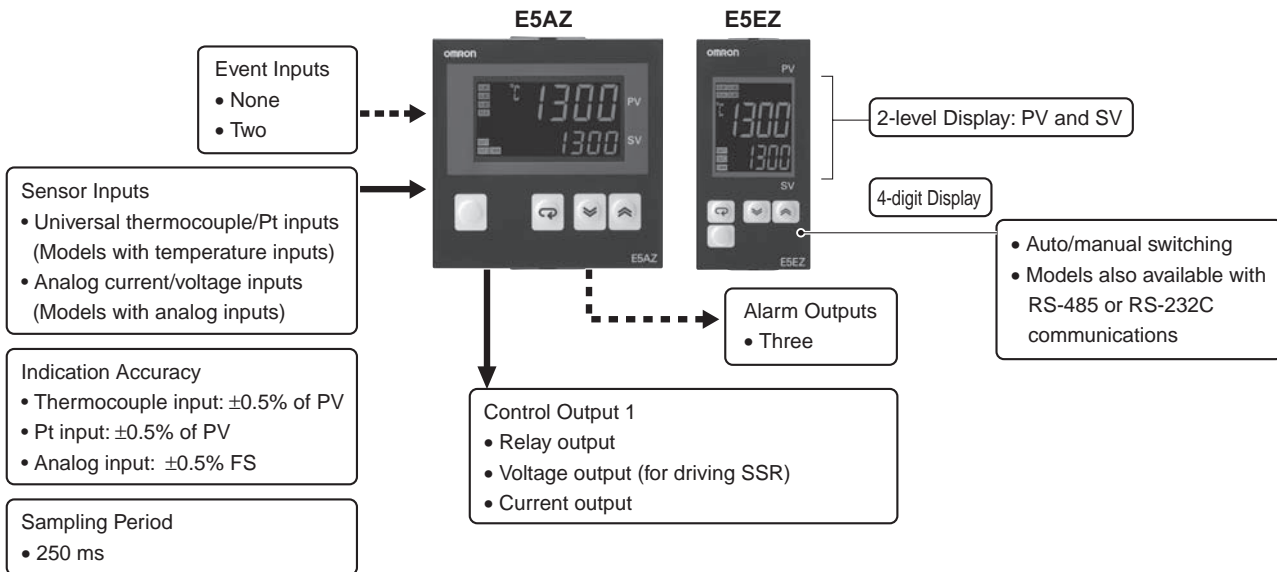

## Model Number Structure

### Model Number Legend

#### Controllers

E5AZ/EZ-□3□□□□□  
1 2 3 4 5 6

#### 1. Control Output 1

- R: Relay output
- Q: Voltage output (for driving SSR)
- C: Current output

#### 2. Number of Alarms

- 3: Three alarms

#### 3. Heater Burnout/Heater Short

- Blank: None
- H: Heater burnout/Heater short detection (CT1)

#### 4. Option

- Blank: None
- M: Option Unit can be mounted.

#### 5. Input Type

- T: Thermocouple, infrared sensor/platinum resistance thermometer
- L: Analog current/voltage input

#### 6. Power Supply Voltage

- Blank: 100 to 240 VAC
- D: 24 VAC/VDC

#### Option Units

E53-AZ□  
1 2

#### 1. Applicable Controller

- AZ: E5AZ/E5EZ

#### 2. Function

- 01: RS-232C communications
- 03: RS-485 communications
- B: Two event inputs

## Ordering Information

### Controllers with Terminal Blocks

Size	Power supply voltage	Input type	Alarm output	Control output	Functions		Previous model	New model
					Heater burnout	Mounting option units		
1/4 DIN 96 × 96 × 78 (W × H × D)	100 to 240 VAC	Thermocouple or Resistance thermometer	3	Relay output	No	No	E5AZ-R3 E5AZ-A3 + E53-AZR	E5AZ-R3T
				Voltage output (for driving SSR)	No	No	E5AZ-Q3 E5AZ-A3 + E53-AZQ	E5AZ-Q3T
				Current output	No	No	E5AZ-C3 E5AZ-A3 + E53-AZC	E5AZ-C3T
				Relay output	No	Yes	E5AZ-R3 + E53-AZM	E5AZ-R3MT
				Voltage output (for driving SSR)	No	Yes	E5AZ-Q3 + E53-AZM	E5AZ-Q3MT
				Current output	No	Yes	E5AZ-C3 + E53-AZM	E5AZ-C3MT
				Relay output	Yes (CT1)	Yes	E5AZ-R3 + E53-AZM + E53-AZH	E5AZ-R3HMT
				Voltage output (for driving SSR)	Yes (CT1)	Yes	E5AZ-Q3 + E53-AZM + E53-AZH	E5AZ-Q3HMT
				Relay output	Yes (CT1)	Yes	None	E5AZ-R3HML
	24 VAC/VDC	Analog (current/ voltage)	3	Relay output	No	Yes	None	E5AZ-R3MTD
				Voltage output (for driving SSR)	No	Yes	None	E5AZ-Q3MTD
				Current output	No	Yes	None	E5AZ-C3MTD
				Relay output	Yes (CT1)	Yes	None	E5AZ-R3HMTD
				Voltage output	Yes (CT1)	Yes	None	E5AZ-Q3HMTD
				Relay output	Yes (CT1)	Yes	None	E5AZ-R3HMLD
				Voltage output (for driving SSR)	Yes (CT1)	Yes	None	E5AZ-Q3HMLD
				Current output	---	Yes	None	E5AZ-C3MLD

## Controllers with Terminal Blocks

Size	Power supply voltage	Input type	Alarm output	Control output	Functions		Previous model	New model
					Heater burnout	Mounting option units		
1/8 DIN 48 × 96 × 78 (W × H × D)	100 to 240 VAC	Thermocouple or Resistance thermometer	3	Relay output	No	No	E5EZ-R3 E5EZ-A3 + E53-AZR	E5EZ-R3T
				Voltage output (for driving SSR)	No	No	E5EZ-Q3 E5EZ-A3 + E53-AZQ	E5EZ-Q3T
				Current output	No	No	E5EZ-C3 E5EZ-A3 + E53-AZC	E5EZ-C3T
				Relay output	No	Yes	E5EZ-R3 + E53-AZM	E5EZ-R3MT
				Voltage output (for driving SSR)	No	Yes	E5EZ-Q3 + E53-AZM	E5EZ-Q3MT
				Current output	No	Yes	E5EZ-C3 + E53-AZM	E5EZ-C3MT
				Relay output	Yes (CT1)	Yes	E5EZ-R3 + E53-AZM + E53-AZH	E5EZ-R3HMT
				Voltage output (for driving SSR)	Yes (CT1)	Yes	E5EZ-Q3 + E53-AZM + E53-AZH	E5EZ-Q3HMT
				Relay output	Yes (CT1)	Yes	None	E5EZ-R3HML
	Analog (current/ voltage)	3	Voltage output (for driving SSR)	Yes (CT1)	Yes	None	E5EZ-Q3HML	
			Current output	No	Yes	None	E5EZ-C3ML	
			Relay output	No	Yes	None	E5EZ-R3MTD	
	24 VAC/VDC	Thermocouple or Resistance thermometer	3	Voltage output (for driving SSR)	No	Yes	None	E5EZ-Q3MTD
				Current output	No	Yes	None	E5EZ-C3MTD
				Relay output	Yes (CT1)	Yes	None	E5EZ-R3HMTD
				Voltage output	Yes (CT1)	Yes	None	E5EZ-Q3HMTD
				Relay output	Yes (CT1)	Yes	None	E5EZ-R3HMLD
				Voltage output (for driving SSR)	Yes (CT1)	Yes	None	E5EZ-Q3HMLD
Analog (current/ voltage)		3	Current output	-	Yes	None	E5EZ-C3MLD	

## Option Units

Name	Function	Model
Communications Unit	RS-232C Communications	E53-AZ01
	RS-485 Communications	E53-AZ03
Event Input Unit	Event input	E53-AZB

## Accessories (Order Separately)

### USB-Serial Conversion Cable

Model
E58-CIFQ1

### Terminal Cover

Connectable models	Model
E5AZ	E53-COV11
E5EZ	

### Waterproof Packing

Connectable models	Model
E5AZ	Y92S-P4
E5EZ	Y92S-P5

### Current Transformers (CTs)

Hole diameter	Model
5.8 dia.	E54-CT1
12.0 dia.	E54-CT3



## Specifications

### Ratings

<b>Power supply voltage</b>	<b>100 to 240 VAC, 50/60 Hz</b>	<b>24 VAC, 50/60 Hz or 24 VDC</b>
<b>Operating voltage range</b>	85% to 110% of rated supply voltage	
<b>Power consumption</b>	8.5 VA	6 VA (24 VAC)/4 W (24 VDC)
<b>Sensor input</b>	Models with temperature inputs Thermocouple: K, J, T, E, L, U, N, R, S, or B Platinum resistance thermometer: Pt100 or JPt100 Infrared temperature sensor: 10 to 70°C, 60 to 120°C, 115 to 165°C, or 140 to 260°C Voltage input: 0 to 50 mV	
	Models with analog inputs Current input: 4 to 20 mA or 0 to 20 mA Voltage input: 1 to 5 V, 0 to 5 V, or 0 to 10 V	
<b>Input impedance</b>	Current input: 150 Ω, Voltage input: 1 MΩ (Use a 1:1 connection when connecting the ES2-HB.)	
<b>Control output</b>	<b>Relay output</b>	SPST-NO, 250 VAC, 5 A (resistive load), electrical life: 100,000 operations, minimum applicable load: 5 V, 10 mA
	<b>Voltage output (for driving SSR)</b>	Output voltage: 12 VDC +15%/–20% (PNP), max. load current: 40 mA, with short-circuit protection circuit
	<b>Current output</b>	4 to 20 mA DC/0 to 20 mA DC, load: 600 Ω max., resolution: approx. 2,700
<b>Alarm output</b>	SPST-NO, 250 VAC, 2 A (resistive load), electrical life: 100,000 operations, minimum applicable load: 5 V, 10 mA	
<b>Event input</b>	<b>Contact input</b>	ON: 1 kΩ max., OFF: 100 kΩ min.
	<b>Non-contact input</b>	ON: Residual voltage: 1.5 V max., OFF: Leakage current: 0.1 mA max.
	Outflow current: Approx. 7 mA per point	
<b>Control method</b>	ON/OFF control or 2-PID control (with auto-tuning)	
<b>Setting method</b>	Digital setting using front panel keys	
<b>Indication method</b>	11-segment digital display and individual indicators (7-segments displays also possible) Character height: E5AZ: PV: 15 mm, SV: 9.5 mm E5EZ: PV: 14 mm, SV: 9.5 mm	
<b>Other functions</b>	Manual output, heating/cooling control, transfer output (on some models), loop break alarm, multi SP, MV limiter, input digital filter, self-tuning, temperature input shift, run/stop, protection functions, etc.	
<b>Ambient operating temperature</b>	–10 to 55°C (with no icing or condensation)	
<b>Ambient operating humidity</b>	25% to 85%	
<b>Storage temperature</b>	–25 to 65°C (with no icing or condensation)	

## Input Ranges

### Thermocouples/Platinum Resistance Thermometers (Universal Inputs)

Input Type	Platinum resistance thermometer				Thermocouple												Infrared temperature sensor				Analog input			
	Pt100		JPt100		K	J	T	E	L	U	N	R	S	B	10 to 70°C	60 to 120°C	115 to 165°C	140 to 260°C						
Temperature range (°C)	850	500.0	100.0	500.0	1300	500.0	850	400.0	400	400.0	600	850	400	400.0	1300	1700	1700	1800	90	120	165	260	Usable in the following ranges by scaling: -1999 to 9999 or -199.9 to 999.9	
Setting number	0	1	2	3	4	5	6	7	8	9	10	11	12	13	14	15	16	17	18	19	20	21		22

The applicable standards for the input types are as follows:

K, J, T, E, N, R, S, B: IEC 584-1

L: Fe-CuNi, DIN 43710-1985

U: Cu-CuNi, DIN 43710-1985

Pt100: IEC 751

JPt100: JIS C 1604-1989, JIS C 1606-1989

Shaded settings are the default settings.







### Models with Analog Inputs

Input Type	Current		Voltage		
Input specification	4 to 20mA	0 to 20 mA	1 to 5 V	0 to 5 V	0 to 10 V
Setting range	Usable in the following ranges by scaling: -1999 to 9999, -199.9 to 999.9, -19.99 to 99.99 or -1.999 to 9.999				
Setting number	0	1	2	3	4

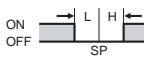
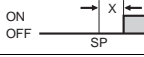
Shaded settings are the default settings.

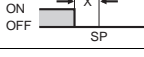
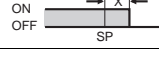
## Alarm Types

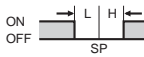
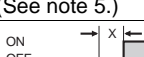
Select alarm types out of the 12 alarm types listed in the following table.

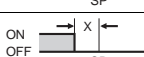
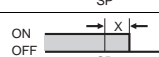
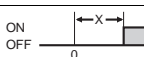
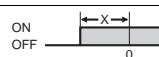
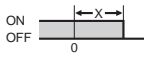
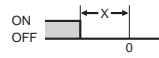
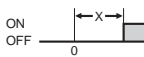
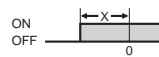
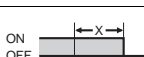
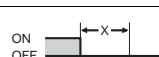
Set value	Alarm type	Alarm output operation	
		When X is positive	When X is negative
0	Alarm function OFF	Output OFF	
1 (See note 1.)	Upper- and lower-limit		(See note 2.)
2	Upper limit		
3	Lower limit		
4 (See note 1.)	Upper- and lower-limit range		(See note 3.)
5 (See note 1.)	Upper- and lower-limit with standby sequence		(See note 4.)
6	Upper-limit with standby sequence		
7	Lower-limit with standby sequence		
8	Absolute-value upper-limit		
9	Absolute-value lower-limit		
10	Absolute-value upper-limit with standby sequence		
11	Absolute-value lower-limit with standby sequence		
12 (See note 6.)	LBA (for alarm 1 type only)	---	

**Note: 1.** With set values 1, 4 and 5, the upper and lower limit values can be set independently for each alarm type, and are expressed as "L" and "H."

**2.** Set value: 1, Upper- and lower-limit alarm

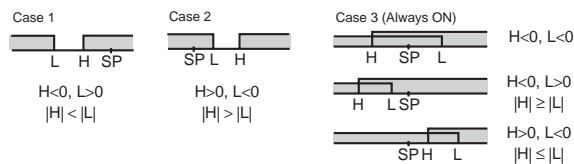

**3.** Set value: 4, Upper- and lower-limit range

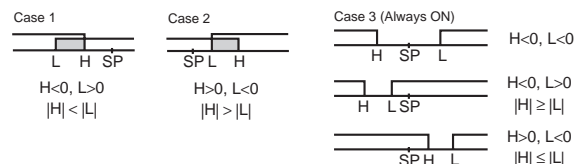

**4.** Set value: 5, Upper- and lower-limit with standby sequence  
For Upper- and Lower-Limit Alarm Described Above

- Case 1 and 2  
Always OFF when the upper-limit and lower-limit hysteresis overlaps.
- Case 3: Always OFF

**5.** Set value: 5, Upper- and lower-limit with standby sequence  
Always OFF when the upper-limit and lower-limit hysteresis overlaps.

**6.** Set value: 12, LBA (loop break alarm) can be set only for alarm 1 type.

Set the alarm types for alarms 1 to 3 independently in the initial setting level. The default setting is 2 (upper limit).

## Characteristics

<b>Indication accuracy</b>	Thermocouple: (See note 1.) (±0.5% of indicated value or ±1°C, whichever is greater) ±1 digit max. Platinum resistance thermometer: (±0.5% of indicated value or ±1°C, whichever is greater) ±1 digit max. Analog input: ±0.5% FS ±1 digit max. CT input: ±5% FS ±1 digit max.
<b>Influence of temperature (See note 2.)</b>	R, S, and B thermocouple inputs: (±1% of PV or ±10°C, whichever is greater) ±1 digit max. Other thermocouple inputs: (±1% of PV or ±4°C, whichever is greater) ±1 digit max. ±10°C for -100°C or less for K sensors Platinum resistance thermometer inputs: (±1% of PV or ±2°C, whichever is greater) ±1 digit max. Analog inputs: (±1% of FS) ±1 digit max.
<b>Influence of voltage (See note 2.)</b>	
<b>Hysteresis</b>	Models with thermocouple/platinum resistance thermometer input (universal input): 0.1 to 999.9 EU (in units of 0.1 EU) (See note 3.) Models with analog input: 0.01 to 99.99% FS (in units of 0.01% FS)
<b>Proportional band (P)</b>	Models with thermocouple/platinum resistance thermometer input (universal input): 0.1 to 999.9 EU (in units of 0.1 EU) (See note 3.) Models with analog input: 0.1 to 999.9% FS (in units of 0.1% FS)
<b>Integral time (I)</b>	0 to 3999 s (in units of 1 s)
<b>Derivative time (D)</b>	0 to 3999 s (in units of 1 s)
<b>Control period</b>	0.5, 1 to 99 s (in units of 1 s)
<b>Manual reset value</b>	0.0 to 100.0% (in units of 0.1%)
<b>Alarm setting range</b>	-1999 to 9999 (decimal point position depends on input type)
<b>Sampling period</b>	250 ms
<b>Affect of signal source resistance</b>	Thermocouple: 0.1°C/Ω max. (100 Ω max.) (See note 4.) Platinum resistance thermometer: 0.4°C/Ω max. (10 Ω max.)
<b>Insulation resistance</b>	20 MΩ min. (at 500 VDC)
<b>Dielectric strength</b>	2,000 VAC, 50 or 60 Hz for 1 min (between terminals with different charge)
<b>Vibration resistance</b>	<b>Malfunction</b>
	<b>Destruction</b>
<b>Shock resistance</b>	<b>Malfunction</b>
	<b>Destruction</b>
<b>Weight</b>	<b>E5AZ</b>
	<b>E5EZ</b>
<b>Degree of protection</b>	Front panel: IP66 (indoor use). Rear case: IP20, Terminals: IP00
<b>Memory protection</b>	Non-volatile memory (number of writes: 1,000,000 times)
<b>EMC</b>	Emission Enclosure: EN55011 Group1 Class A Emission AC Mains: EN55011 Group1 Class A Immunity ESD: EN61000-4-2 4 kV contact discharge (level 2) 8 kV air discharge (level 3) Immunity RF-interference: EN61000-4-3 10 V/m (80-1000 MHz, 1.4-2.0 GHz amplitude modulated) (level 3) 10 V/m (900 MHz pulse modulated) Immunity Conducted Disturbance: EN61000-4-6 3 V (0.15 to 80 MHz) (level 2) Immunity Burst: EN61000-4-4 2 kV Power-line (level 3) 1 kV I/O signal-line (level 3) (See note 5.) Immunity Surge: EN61000-4-5 1kV line to line Power line, output line (relay output) 2 kV line to ground Power line, output line (relay output) 1 kV line to ground Input line (communication) Immunity Voltage Dip/Interrupting: EN61000-4-11 0.5 cycle, 100% (rated voltage)
<b>Approved standards</b>	UL 61010C-1 CSA C22.2 No.1010.1
<b>Conformed standards</b>	EN61326, EN61010-1, IEC61010-1 VDE0106 Part 100 (Finger protection), when the terminal cover is mounted.

- Note: 1.** The indication accuracy of K thermocouples in the -200 to 1300°C range, T and N thermocouples at a temperature of -100°C max., and U and L thermocouples at any temperature is ±2°C ±1 digit maximum. The indication accuracy of the B thermocouple at a temperature of 400°C max. is not specified. The indication accuracy of the R and S thermocouples at a temperature of 200°C max. is ±3°C ±1 digit max.
- 2.** Conditions: Ambient temperature: -10°C to 23°C to 55°C, Voltage range: -15% to +10% of rated voltage
- 3.** "EU" stands for Engineering Unit and is used as the unit after scaling. For a temperature sensor, the EU is °C or °F.
- 4.** B, R, and S sensors: 0.2°C/Ω max. (100 Ω max.)

- 5.** When using the E53-AZB, E53-AZ01, or E53-AZ03 Option Unit with the E5AZ-□3□M□□ to satisfy the immunity burst requirements in the EN 61326 standard, always connect a ZCAT2035-0930 Clamp Filter (manufactured by TDK) to the cable for terminals 11, 12, and 13.

## USB-Serial Conversion Cable

<b>Applicable OS</b>	Windows 2000/XP/Vista
<b>Applicable software</b>	Thermo Mini
<b>Applicable models</b>	E5CZ/E5CZ-U/E5AZ/E5EZ
<b>USB interface standard</b>	Conforms to USB Specification 1.1.
<b>DTE speed</b>	38400 bps
<b>Connector specifications</b>	Computer: USB (type A plug) Temperature Controller: Setup Tool port (on bottom of Controller)
<b>Power supply</b>	Bus power (Supplied from USB host controller.)
<b>Power supply voltage</b>	5 VDC
<b>Current consumption</b>	70 mA
<b>Ambient operating temperature</b>	0 to 55°C (with no condensation or icing)
<b>Ambient operating humidity</b>	10% to 80%
<b>Storage temperature</b>	-20 to 60°C (with no condensation or icing)
<b>Storage humidity</b>	10% to 80%
<b>Altitude</b>	2,000 m max.
<b>Weight</b>	Approx. 100 g

**Note:** A driver must be installed in the personal computer. Refer to installation information in the operation manual for the Conversion Cable.

## Communications Specifications

<b>Transmission line connection method</b>	RS-485 multipoint RS-232C
<b>Communications</b>	RS-485 (two-wire, half duplex), RS-232C
<b>Synchronization method</b>	Start-stop synchronization
<b>Baud rate</b>	1200, 2400, 4800, 9600, 19200, or 38400 bps
<b>Transmission code</b>	ASCII
<b>Data length (See note.)</b>	7 or 8 bits
<b>Stop bits (See note.)</b>	1 or 2 bits
<b>Error detection</b>	Vertical parity (none, even, odd) Frame check sequence (FCS) with SYSWAY Block check character (BCC) with CompoWay/F or CRC-16 Modbus
<b>Flow control</b>	None
<b>Interface</b>	RS-485, RS-232C
<b>Retry function</b>	None
<b>Communications buffer</b>	40 bytes
<b>Send data wait time</b>	0 to 99 ms Default: 20 ms

**Note:** The baud rate, data length, stop bits, and vertical parity can be individually set using the Communications Setting Level.

## Current Transformer (Order Separately)

### Ratings

<b>Dielectric strength</b>	1,000 VAC for 1 min
<b>Vibration resistance</b>	50 Hz, 98 m/s <sup>2</sup>
<b>Weight</b>	E54-CT1: Approx. 11.5 g, E54-CT3: Approx. 50 g
<b>Accessories (E54-CT3 only)</b>	Armatures (2) Plugs (2)

### Heater Burnout and Heater Short Alarms

<b>Maximum heater current</b>	50 A AC
<b>Input current indication accuracy</b>	±5% FS ±1 digit max.
<b>Heater burnout alarm setting range</b>	0.1 to 49.9 A (in units of 0.1 A) 0.0 A: Heater burnout/Heater short alarm output turns OFF. 50.0 A: Heater burnout/Heater short alarm output turns ON. Minimum detection ON time: 190 ms (See note 1.)
<b>Heater short alarm setting range</b>	0.1 to 49.9 A (in units of 0.1 A) 0.0 A: Heater burnout/Heater short alarm output turns ON. 50.0 A: Heater burnout/Heater short alarm output turns OFF. Minimum detection OFF time: 190 ms (See note 2.)

**Note:** 1. If the ON time of control output 1 is less than 190 ms, heater burnout detection and the heater current will not be measured.  
 2. If the OFF time of control output 1 is less than 190 ms, heater short alarm and the heater current will not be measured.

### Electrical Life Expectancy Curve for Relays (Reference Values)

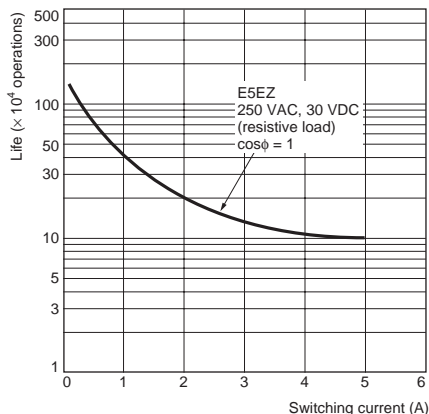

### E54-CT1 Thru-current (Io) vs. Output Voltage (Eo) (Reference Values)

Maximum continuous heater current: 50 A (50/60 Hz)  
 Number of windings: 400±2  
 Winding resistance: 18±2 Ω

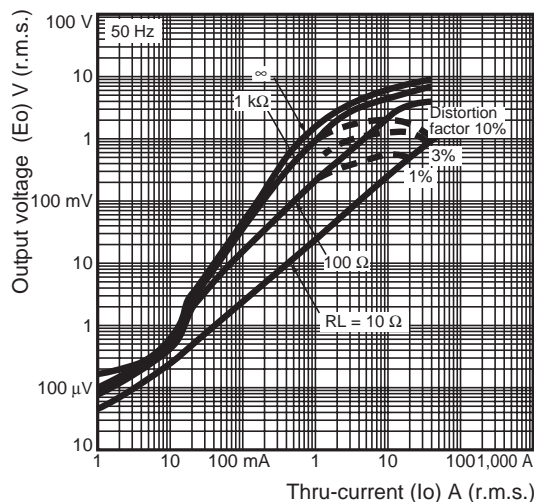

### E54-CT3 Thru-current (Io) vs. Output Voltage (Eo) (Reference Values)

Maximum continuous heater current: 120 A (50/60 Hz)  
 (Maximum continuous heater current for an OMRON Temperature Controller is 50 A.)  
 Number of windings: 400±2  
 Winding resistance: 8±0.8 Ω

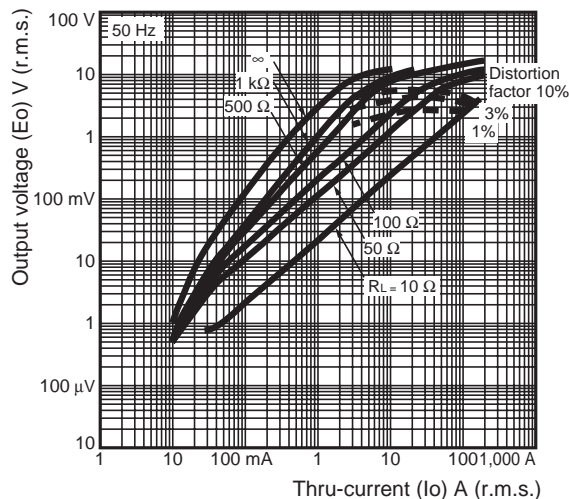

# E5AZ/E5EZ

## External Connections

- The voltage output for control output 1 is not electrically insulated from the internal circuits. When using a grounding thermocouple, do not connect any of the control output terminals to ground. If the control output terminals are connected to ground, errors will occur in the measured temperature values as a result of leakage current.

### E5AZ/E5EZ

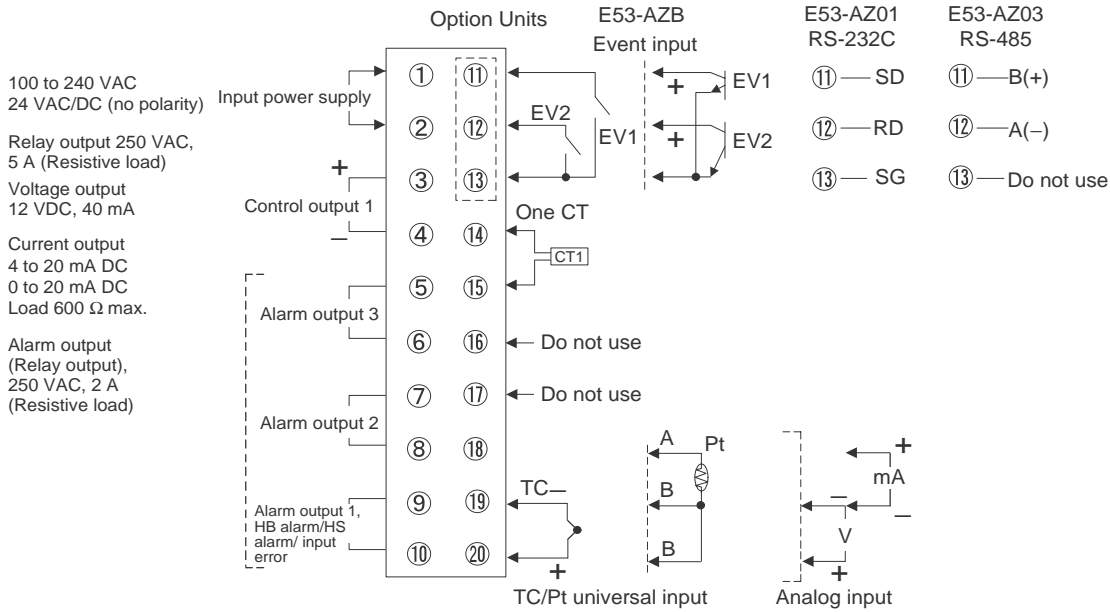

## Nomenclature

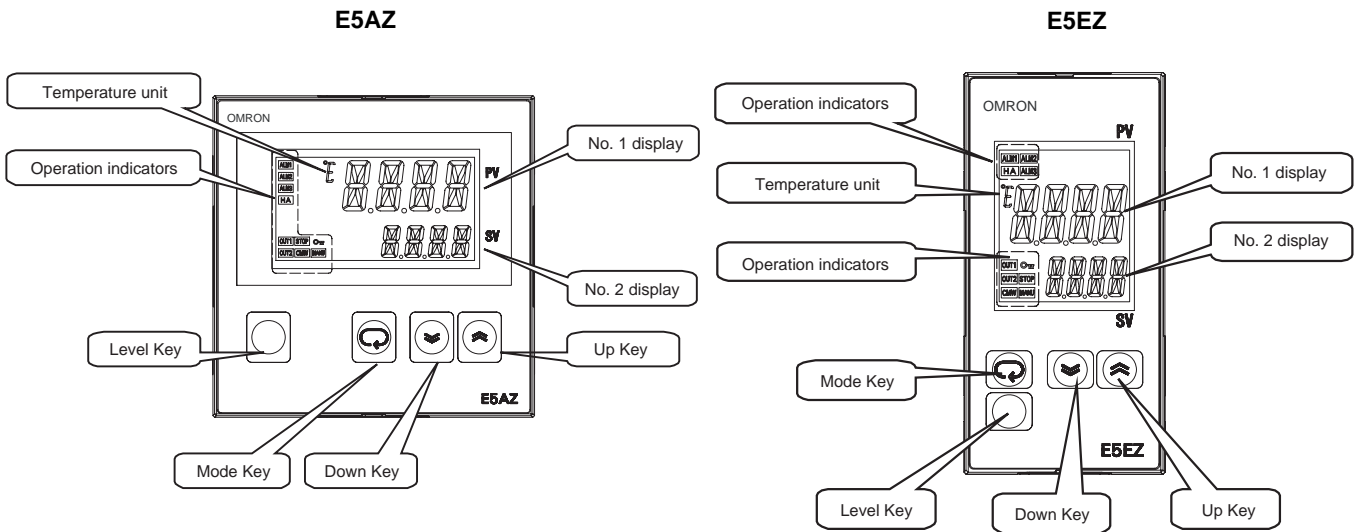

Dimensions

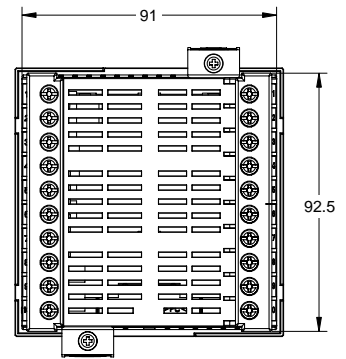
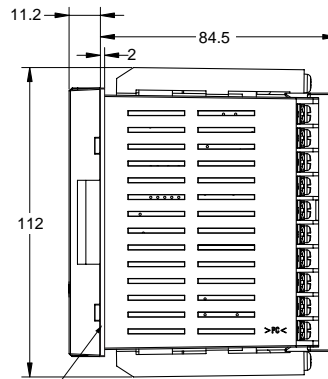
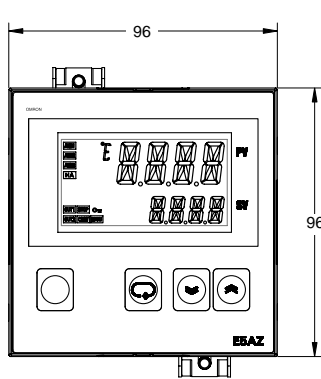
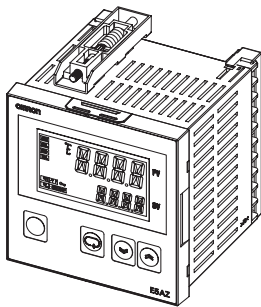
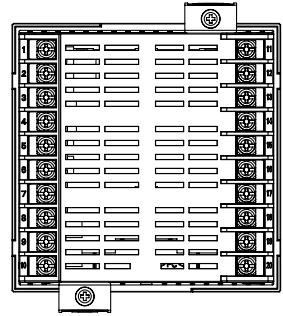
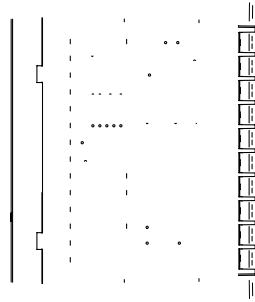
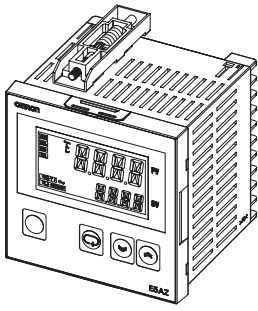

Waterproof Packing  
(Accessory)

Panel Cutout

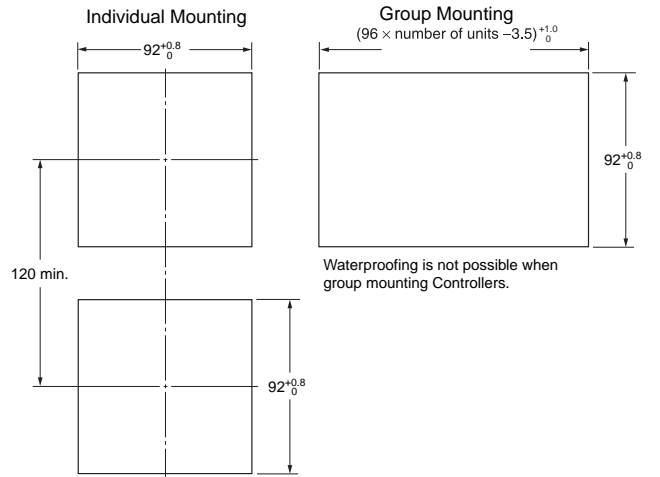

## E5EZ Terminal Models

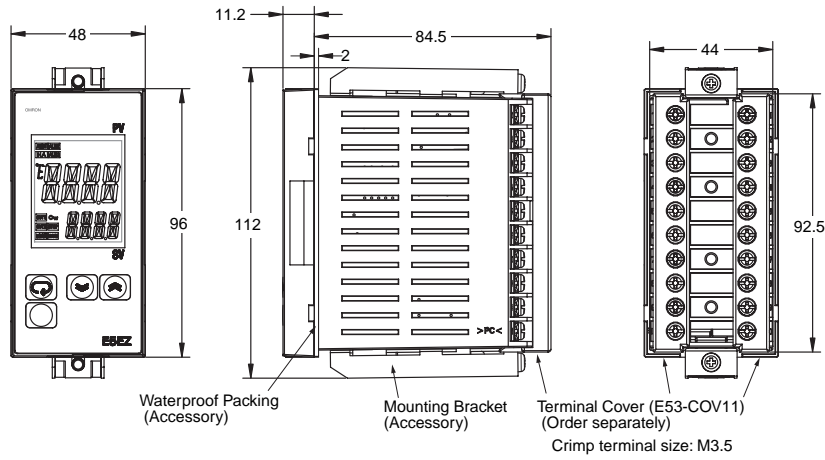
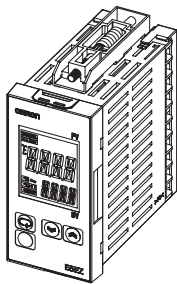
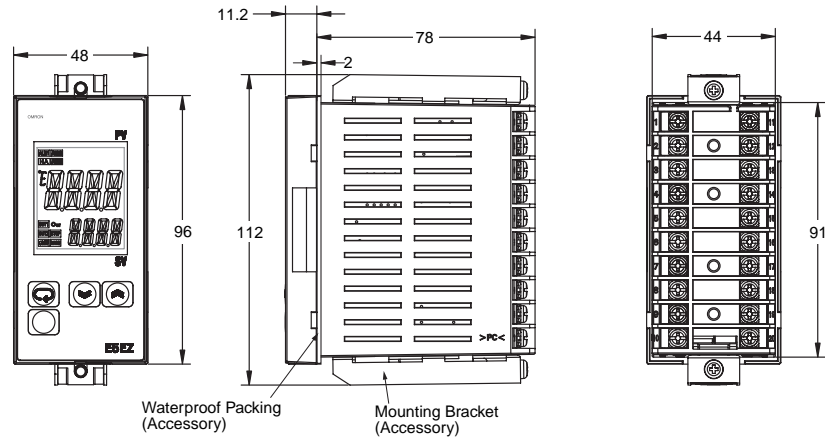
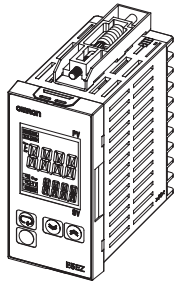

### Panel Cutout

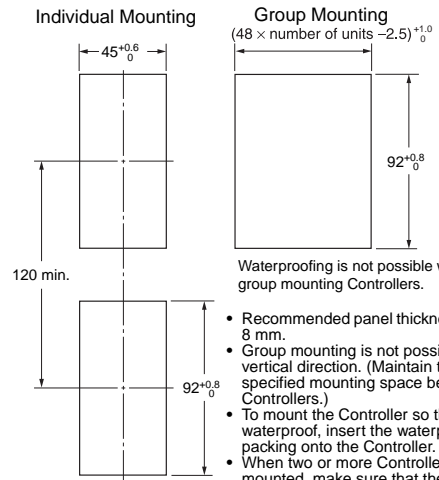

Waterproofing is not possible when group mounting Controllers.

- Recommended panel thickness is 1 to 8 mm.
- Group mounting is not possible in the vertical direction. (Maintain the specified mounting space between Controllers.)
- To mount the Controller so that it is waterproof, insert the waterproof packing onto the Controller.
- When two or more Controllers are mounted, make sure that the surrounding temperature does not exceed the ambient operating temperature given in the specifications.

**Note:** To remove the Controller from the case, loosen the screw at the bottom of the front panel with a screwdriver while pressing down on the hook at the top of the front panel.



Accessories

USB-Serial Conversion Cable (Order Separately)

E58-CIFQ1

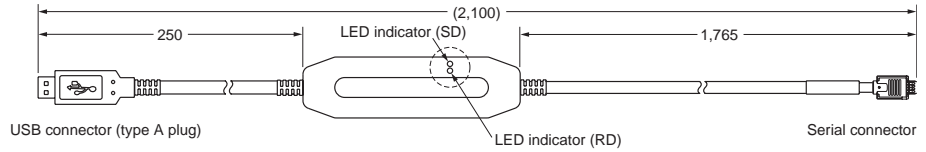
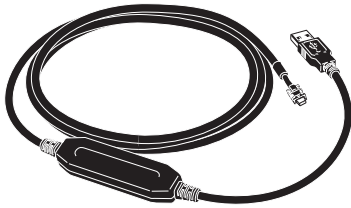

Terminal Covers

E53-COV11

(Two Covers provided.)  
(Order Separately)

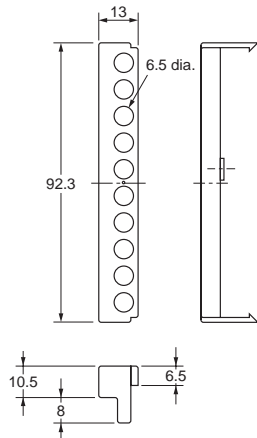
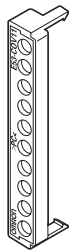

Waterproof Packing

Y92S-P4 (for DIN 96 × 96)

Y92S-P5 (for DIN 48 × 96)

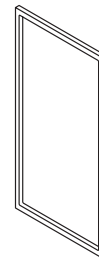
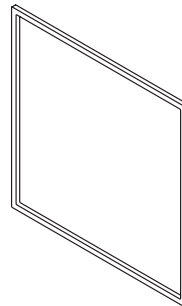

Order the Waterproof Packing separately if it becomes lost or damaged. The Waterproof Packing can be used to achieve an IP66 (indoor use) degree of protection.

(Deterioration, shrinking, or hardening of the waterproof packing may occur depending on the operating environment. Therefore, periodic replacement is recommended to ensure the level of waterproofing specified in IP66 (indoor use). The time for periodic replacement depends on the operating environment. Be sure to confirm this point at your site. Consider one year a rough standard. OMRON shall not be liable for the level of water resistance if the customer does not perform periodic replacement.)

The Waterproof Packing does not need to be attached if a waterproof structure is not required.

Unit Labels (Order Separately)

Y92S-L1 Type

UNIT LABEL					11.8
mV	V	mA	A	kW	4.8
mm	cm	m	km	g	
kg	m <sup>3</sup>	ℓ	°C	°F	
K	%RH	%	ℓ/s	ℓ/min	
ℓ/h	m <sup>3</sup> /s	m <sup>3</sup> /min	m <sup>3</sup> /h	kg/h	
rpm	ppm	pH	kPa	mmHg	
mmH <sub>2</sub> O	mH <sub>2</sub> O	bar	Torr	mmAq	
kgf/cm <sup>2</sup>	g/cm <sup>2</sup>	kg/cm <sup>2</sup>	kg/cm <sup>2</sup> G	kgf/cm <sup>2</sup> G	
TAG No.		TAG No.			

Current Transformers (Order Separately)

E54-CT1

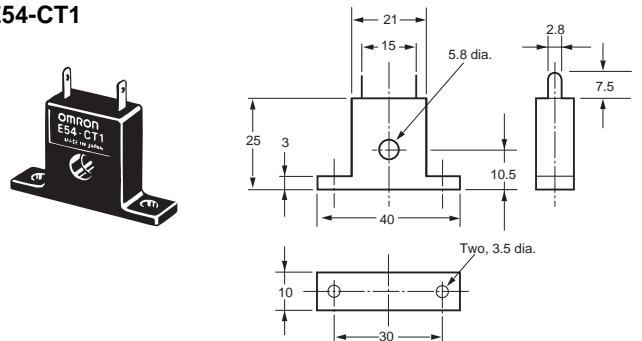

E54-CT3

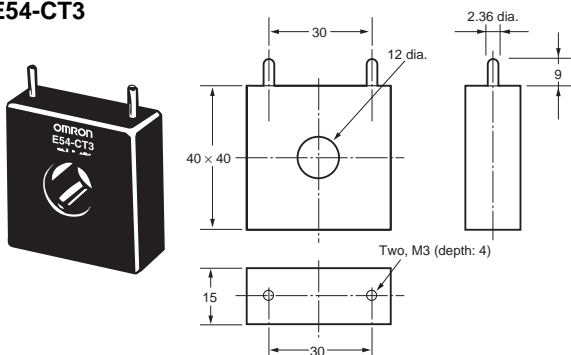

E54-CT3 Accessory

• Armature

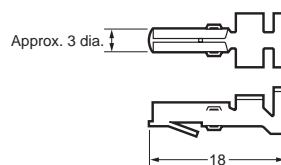

• Plug

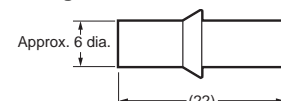

Connection Example

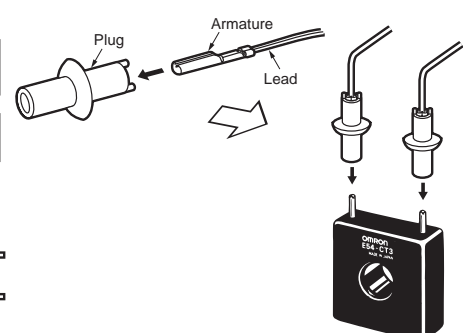

# Operation

## Setting Levels Diagram

This diagram shows all of the setting levels. To move to the advanced function setting level, you must enter passwords. Some parameters are not displayed depending on the protect level setting and the conditions of use. Control stops when you move from the operation level to the initial setting level.

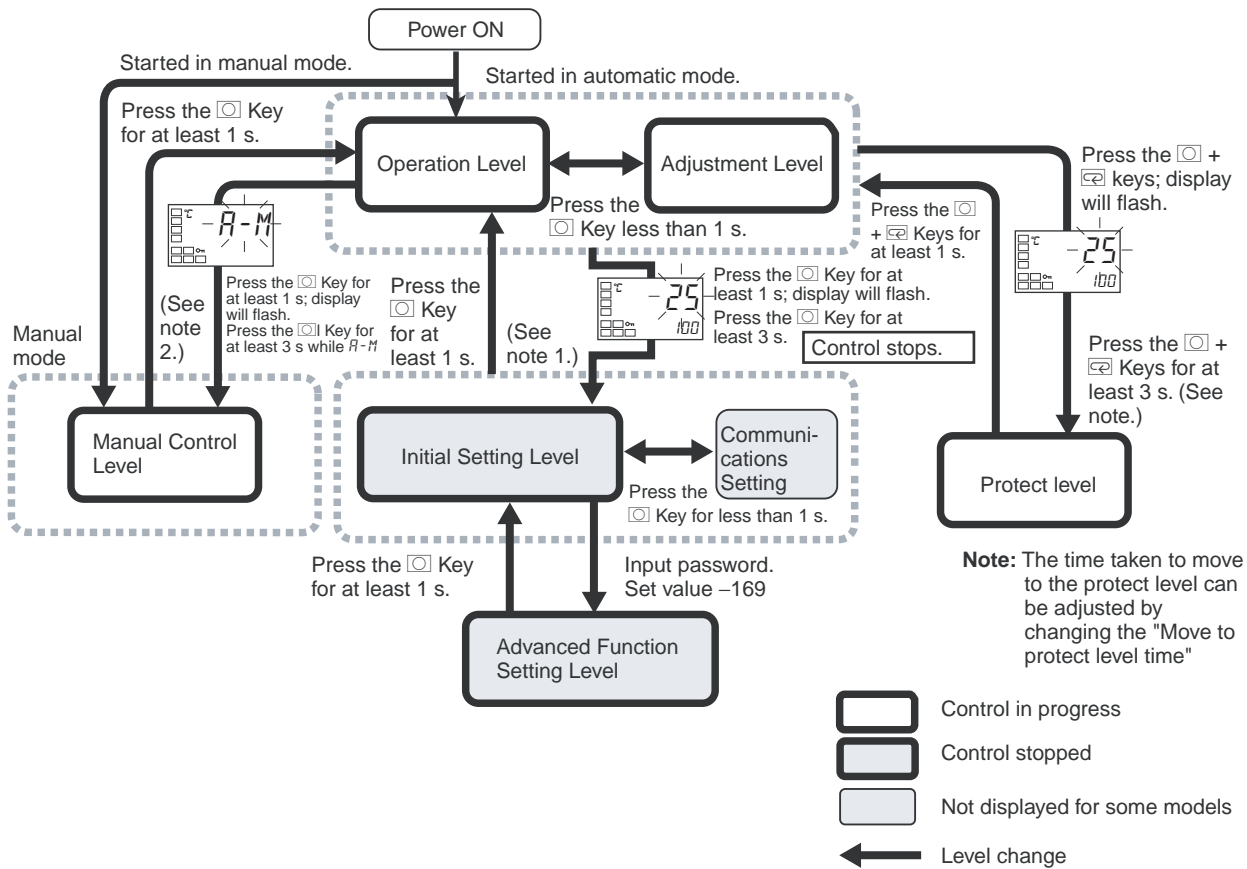

**Note:** The time taken to move to the protect level can be adjusted by changing the "Move to protect level time"

- Note:** 1. Moves to operation level by software reset.  
 2. From the manual control level, key operations can be used to move to the operation level only.

## Error Displays (Troubleshooting)

When an error occurs, the No.1 display shows the error code. Take necessary measure according to the error code, referring the table below.

No. 1 display	Meaning	Action	Output status at error	
			Control outputs	Alarm outputs
S.ERR (S. Err)	Input error (See note 2.)	Check the wiring of inputs for miswiring, disconnections, and short-circuits and check the input type.	OFF	Operates as above the upper limit.
	A/D converter error (See note 2.)	Check for an input error and then cycle the power supply. If the same error is still displayed, repairs will be necessary. If the Temperature Controller is normal after cycling the power supply, the error may have been caused by noise. Check for noise being generated nearby.	OFF	OFF
E111 (E111)	Memory error	Cycle the power supply. If the same error is still displayed, repairs will be necessary.	OFF	OFF
H.ERR (H. Err)	HB error (See note 2.)	If the Temperature Controller is normal after cycling the power supply, the error may have been caused by noise. Check for noise being generated nearby.	OFF	OFF

- Note:** 1. If the input value exceeds the display limit (-1999 to 9999), though it is within the control range, □□□□ will be displayed under -1999 and □□□□ above 9999. Under these conditions, control output and alarm output will operate normally. For details on the control range, refer to the E5CZ/E5CZ-U/E5AZ/E5EZ Digital Temperature Controllers User's Manual (Cat. No. H207).  
 2. These errors are displayed only when the PV/SP is displayed. Errors are not displayed in other display modes.



# Parameters

Some parameters are not displayed depending on the model of the Controller and parameter settings. For details, refer to the *E5CZ/E5CZ-U/E5AZ/E5EZ Digital Temperature Controllers User's Manual* (Cat. No. H207).

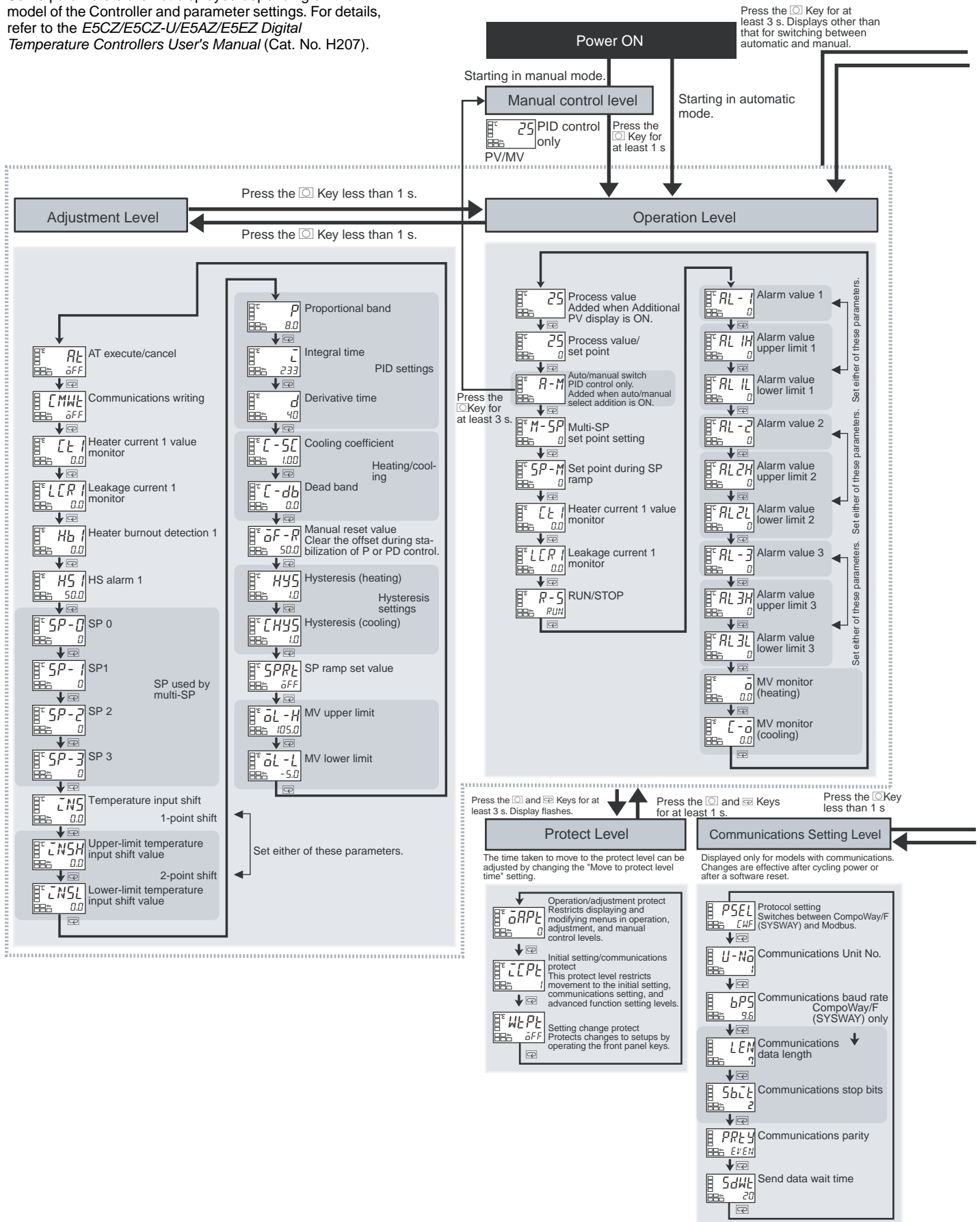

Press the Key for at least 1 s.

Press the Key less than 1 s.

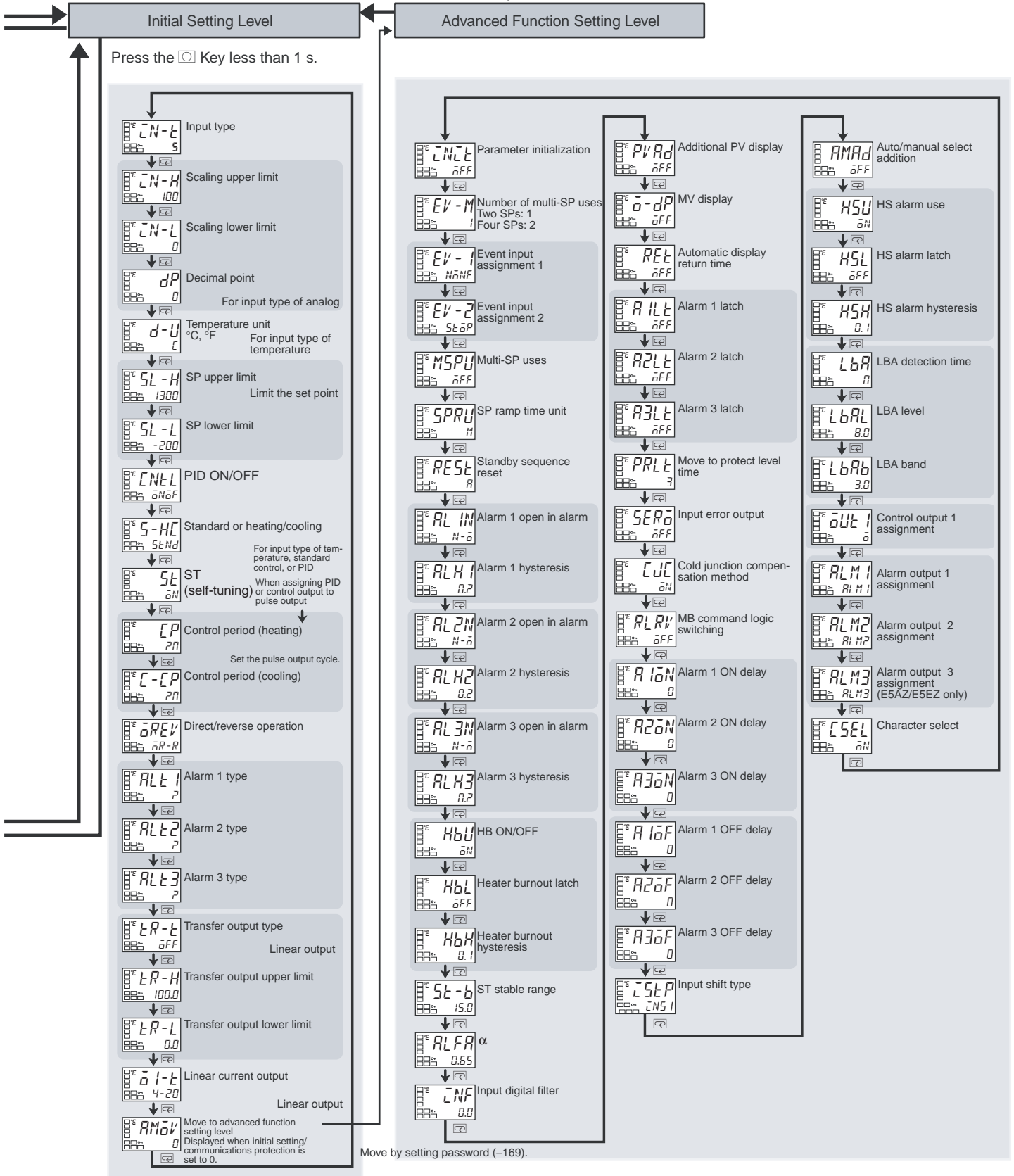

## Improved Functions

### Changes

Model numbers have been changed to allow for universal input specifications.

#### Before Change

E5□Z-□□□□ (models for thermocouples and platinum resistance thermometers)  
 None (models for analog input)  
 None (models for 24 VAC/VDC)

#### After Change

E5□Z-□□□□T (models for thermocouples and platinum resistance thermometers)  
 E5□Z-□□□□L (models for analog input)  
 E5□Z-□□□□D (models for 24 VAC/VDC)

### Precautions in Replacing Previous Controllers

- Previous E5□Z Controllers cannot be removed from the case for replacement with new models. Replace the case at the same time.

The following items have not changed in comparison to the previous E5□Z models: Panel cutout, Internal panel dimensions for panel mounting, wiring screw sizes, wiring terminal arrangement, and parameter setting methods.

### Improved Functions

The previous and new models can be easily differentiated by looking at the front panel. The OMRON logo is in a different position.

Item	Previous models (OMRON logo: lower left)	Improved models (OMRON logo: upper left)
<b>Front panel</b>  <b>E5CZ/E5CZ-U</b>		
<b>E5AZ</b>		
<b>E5EZ</b>		

## Specifications (Main Changes)

### Ratings

Item		Previous models	Improved models
Power consumption	E5CZ	7 VA (100 to 240 VAC, 50/60 Hz) 4 VA/3 W (24 VAC, 50/60 Hz or 24 VDC)	7.5 VA (100 to 240 VAC, 50/60 Hz) 5.5 VA/3.5 W (24 VAC, 50/60 Hz or 24 VDC)
	E5CZ-U	(No models with plug-in type)	6 VA (100 to 240 VAC, 50/60 Hz) 4.5 VA/2.5 W (24 VAC, 50/60 Hz or 24 VDC)
	E5AZ	9 VA (100 to 240 VAC, 50/60 Hz) 5 VA/4 W (24 VAC, 50/60 Hz or 24 VDC)	8.5 VA 6 VA/4 W
	E5EZ	9 VA (100 to 240 VAC, 50/60 Hz) 5 VA/4 W (24 VAC, 50/60 Hz or 24 VDC)	8.5 VA 6 VA/4 W
Sensor input		(No models with analog inputs)	E5□Z-□□□□L□ (Models with analog inputs added.) Current input: 4 to 20 mA or 0 to 20 mA Voltage input: 1 to 5 V, 0 to 5 V, or 0 to 10 V
Control output 1	Relay	E5CZ-R□□□□ SPST-NO, 250 VAC, 3 A (resistive load) Electrical life: 100,000 operations	E5CZ-R□□□□ SPST-NO, 250 VAC, 3 A (resistive load) Electrical life: 100,000 operations
		(No models with plug-in type)	E5CZ-R□□□□U SPDT, 250 VAC, 3 A (resistive load) Electrical life: 100,000 operations
		E5AZ-R□□□□ SPST-NO, 250 VAC, 5 A (resistive load) Electrical life: 100,000 operations	E5AZ-R□□□□□ SPST-NO, 250 VAC, 5 A (resistive load) Electrical life: 100,000 operations
		E5EZ-R□□□□ SPST-NO, 250 VAC, 5 A (resistive load) Electrical life: 100,000 operations	E5EZ-R□□□□□ SPST-NO, 250 VAC, 5 A (resistive load) Electrical life: 100,000 operations
	Voltage	E5CZ-Q□□□□ 12 VDC ±15% (PNP) Max. load current: 21 mA With short-circuit protection	E5CZ-Q□□□□ 12 VDC ±15% (PNP) Max. load current: 21 mA With short-circuit protection
		(No models with plug-in type)	E5CZ-Q□□□□U 12 VDC ±15% (PNP) Max. load current: 21 mA With short-circuit protection
		E5AZ-Q□□□□ 12 VDC +15%/–20% (PNP) Max. load current: 40 mA With short-circuit protection	E5AZ-Q□□□□□ 12 VDC +15%/–20% (PNP) Max. load current: 40 mA With short-circuit protection
		E5EZ-Q□□□□ 12 VDC +15%/–20% (PNP) Max. load current: 40 mA With short-circuit protection	E5EZ-Q□□□□□ 12 VDC +15%/–20% (PNP) Max. load current: 40 mA With short-circuit protection
	Current	E5CZ-C□□□□ 4 to 20 mA DC Load: 600 Ω max. Resolution: Approx. 2,600	E5CZ-C□□□□ 4 to 20 mA DC or 0 to 20 mA DC Load: 600 Ω max. Resolution: Approx. 2,700
		E5AZ-C□□□□ 4 to 20 mA DC Load: 600 Ω max. Resolution: Approx. 2,600	E5AZ-C□□□□ 4 to 20 mA DC or 0 to 20 mA DC Load: 600 Ω max. Resolution: Approx. 2,700
		E5EZ-C□□□□ 4 to 20 mA DC Load: 600 Ω max. Resolution: Approx. 2,600	E5EZ-C□□□□ 4 to 20 mA DC or 0 to 20 mA DC Load: 600 Ω max. Resolution: Approx. 2,700
	Display method	E5CZ/CZ-U	7-segment digital display and single-LED indicators
E5AZ/EZ		7-segment digital display and single-LED indicators	11-segment digital display and single-LED indicator (Improved visibility) (A 7-segment digital display also possible.)
Transfer output		(No models with transfer outputs)	E5□Z-C□□□□ Allocated to current output 4 to 20 mA DC or 0 to 20 mA DC Load: 600 Ω max. Resolution: Approx. 2,700 (4 to 20 mA DC)

## Other Functions

Item	Previous models	Improved models
Display	---	Display character switch (7-segment/11-segment)
Input	Temperature input shift (1-point shift for temperature input, 2-point shift for no-contact sensor input)	Temperature input shift (2-point shift also possible for temperature input)
Output	---	Manual outputs
	---	Loop break alarm
Control	Control period: 1 to 99 s	Control period: 0.5 or 1 to 99 s
Alarm	---	Alarm delays

## Characteristics

Item	Previous models	Improved models
Sampling period	500 ms	250 ms

## Communications Specifications

Item	Previous models	Improved models
Communications protocols	CompoWay/F (SYSWAY)	CompoWay/F (SYSWAY), Modbus
Baud rate	1200, 2400, 4800, 9600, 19200 bps	1200, 2400, 4800, 9600, 19200, 38400 bps

## Heater Burnout/Heater Short Alarm Characteristics

Item		Previous models	Improved models
Maximum heater current	E5CZ	E5CZ-□2M□ with E53-CNH□N Single-phase 50 A AC	E5CZ-□2M□□ with E53-CZH□ Single-phase 50 A AC
	E5AZ/EZ	E5□Z-A3 with E53-AZM and E53-AZH E5□Z-R3 with E53-AZM and E53-AZH E5□Z-Q3 with E53-AZM and E53-AZH Single-phase 50 A AC	E5□Z-□3HM□□ Single-phase 50 A AC
Heater short alarm		---	Heater short alarm



## Precautions

### ⚠ CAUTION

Do not touch the terminals while power is being supplied. Doing so may occasionally result in minor injury due to electric shock.



Do not allow pieces of metal, wire clippings, or fine metallic shavings or filings from installation to enter the product. Doing so may occasionally result in electric shock, fire, or malfunction.



Do not use the product where subject to flammable or explosive gas. Otherwise, minor injury from explosion may occasionally occur.



Do not leave the conversion cable connected to the product. Malfunction may occur due to noise in the cable.



Do not use the Temperature Controller or Conversion Cable if it is damaged. Doing so may occasionally result in minor electric shock or fire.



Never disassemble, modify, or repair the product or touch any of the internal parts. Minor electric shock, fire, or malfunction may occasionally occur.



#### CAUTION - Risk of Fire and Electric Shock

- a) This product is UL recognized as Open Type Process Control Equipment. It must be mounted in an enclosure that does not allow fire to escape externally.
- b) More than one disconnect switch may be required to de-energize the equipment before servicing the product.
- c) Signal inputs are SELV, limited energy. (See note 1.)
- d) Caution: To reduce the risk of fire or electric shock, do not interconnect the outputs of different Class 2 circuits. (See note 2.)



If the output relays are used past their life expectancy, contact fusing or burning may occasionally occur. Always consider the application conditions and use the output relays within their rated load and electrical life expectancy. The life expectancy of output relays varies considerably with the output load and switching conditions.



Tighten the terminal screws to between 0.74 and 0.90 N·m. Loose screws may occasionally result in fire. (See note 3.)



Set the parameters of the product so that they are suitable for the system being controlled. If they are not suitable, unexpected operation may occasionally result in property damage or accidents.



A malfunction in the product may occasionally make control operations impossible or prevent alarm outputs, resulting in property damage. To maintain safety in the event of malfunction of the product, take appropriate safety measures, such as installing a monitoring device on a separate line.



Do not allow pieces of metal or wire cuttings to get inside connectors. Failure to do so may occasionally result in minor electric shock, fire, or damage to equipment.



Do not allow dust and dirt to collect between the pins in the connector on the Conversion Cable. Failure to do so may occasionally result in fire.



When inserting the body of the Temperature Controller into the case, confirm that the hooks on the top and bottom are securely engaged with the case. If the body of the Temperature Controller is not inserted properly, faulty contact in the terminal section or reduced water resistance may occasionally result in fire or malfunction.



- Note:**
1. An SELV circuit is one separated from the power supply with double insulation or reinforced insulation, that does not exceed 30 V r.m.s. and 42.4 V peak or 60 VDC.
  2. A class 2 power supply is one tested and certified by UL as have the current and voltage of the secondary output restricted to specific levels.
  3. The tightening torque for E5CZ-U is 0.5 N·m.

## Precautions for Safe Use

Be sure to observe the following precautions to prevent malfunction or adverse affects on the performance or functionality of the product. Not doing so may occasionally result in faulty operation.

1. This product is specifically designed for indoor use only. Do not use this product outdoors or in any of the following places:
  - Places directly subject to heat radiated from heating equipment.
  - Places subject to splashing liquid or oil atmosphere.
  - Places subject to direct sunlight.
  - Places subject to dust or corrosive gas (in particular, sulfide gas and ammonia gas).
  - Places subject to intense temperature change.
  - Places subject to icing and condensation.
  - Places subject to vibration and large shocks.
2. Use and store the product within the rated ambient temperature and humidity. Gang-mounting two or more Temperature Controllers, or mounting Temperature Controllers above each other may cause heat to build up inside the Temperature Controllers, which will shorten their service life. In such a case, use forced cooling by fans or other means of air ventilation to cool down the Temperature Controllers.
3. To allow heat to escape, do not block the area around the product. Do not block the ventilation holes on the product.
4. Be sure to wire properly with correct polarity of terminals.
5. Use the specified size (M3.5, width 7.2 mm or less) crimped terminals for wiring. To connect bare wires to the terminal block, use stranded or solid copper wires with a gage of AWG24 to AWG14 (equal to a cross-sectional area of 0.205 to 2.081 mm<sup>2</sup>). (The stripping length is 5 to 6 mm.) Up to two wires of the same size and type or two crimp terminals can be inserted into a single terminal.
6. Do not wire the terminals that are not used.
7. To avoid inductive noise, keep the wiring for the product's terminal block away from power cables carry high voltages or large currents. Also, do not wire power lines together with or parallel to product wiring. Using shielded cables and using separate conduits or ducts is recommended. Attach a surge suppressor or noise filter to peripheral devices that generate noise (in particular, motors, transformers, solenoids, magnetic coils, or other equipment that have an inductance component). When a noise filter is used at the power supply, first check the voltage or current, and attach the noise filter as close as possible to the product. Allow as much space as possible between the product and devices that generate powerful high frequencies (high-frequency welders, high-frequency sewing machines, etc.) or surge.
8. Use this product within the rated load and power supply.
9. Make sure that the rated voltage is attained within 2 seconds of turning ON the power by using a switch or relay contact. If the voltage is applied gradually, the power may not be reset or output malfunctions may occur.
10. Make sure that the Temperature Controller has 30 minutes or more to warm up after turning ON the power before starting actual control operations to ensure the correct temperature display.
11. When executing self-tuning, turn ON power to the load (e.g., heater) at the same time as or before supplying power to the product. If power is turned ON to the product before turning ON power to the load, self-tuning will not be performed properly and optimum control will not be achieved.
12. A switch or circuit breaker must be provided close to the product. The switch or circuit breaker must be within easy reach of the operator, and must be marked as a disconnecting means for this unit.
13. Always turn OFF the power supply before pulling out the interior of the product, and never touch nor apply shock to the terminals or electronic components. When inserting the interior of the product, do not allow the electronic components to touch the case.
14. Do not use paint thinner or similar chemical to clean with. Use standard grade alcohol.
15. Design the system (e.g., control panel) considering the 2 seconds of delay that the product's output to be set after power ON.
16. The output may turn OFF when shifting to certain levels. Take this into consideration when performing control.
17. The number of EEPROM write operations is limited. Therefore, use RAM write mode when frequently overwriting data during communications or other operations.

18. Always touch a grounded piece of metal before touching the Temperature Controller to discharge static electricity from your body.
19. Control output that is voltage output is not isolated from the internal circuits. When using a grounded thermocouple, do not connect any of the control output terminals to ground. (Doing so may result in an unwanted circuit path, causing error in the measured temperature.)
20. When replacing the body of the Temperature Controller, check the condition of the terminals. If corroded terminals are used, contact failure in the terminals may cause the temperature inside the Temperature Controller to increase, possibly resulting in fire. If the terminals are corroded, replace the case as well.
21. Use suitable tools when taking the Temperature Controller apart for disposal. Sharp parts inside the Temperature Controller may cause injury.
22. Check the orientation of the connectors on the Conversion Cable before connecting the Conversion Cable. Do not force a connector if it does not connect smoothly. Using excessive force may damage the connector.
23. Do not place heavy object on the Conversion Cable, bend the cable past its natural bending radius, or pull on the cable with undue force.
24. Do not connect or disconnect the Conversion Cable while communications are in progress. Product faults or malfunction may occur.
25. Make sure that the Conversion Cable's metal components are not touching the external power terminals.
26. Do not touch the connectors on the Conversion Cable with wet hands. Electrical shock may result.

## Precautions for Correct Use Service Life

1. Use the product within the following temperature and humidity ranges:
  - Temperature: -10 to 55°C (with no icing or condensation)
  - Humidity: 25% to 85%
 If the product is installed inside a control board, the ambient temperature must be kept to under 55°C, including the temperature around the product.
2. The service life of electronic devices like Temperature Controllers is determined not only by the number of times the relay is switched but also by the service life of internal electronic components. Component service life is affected by the ambient temperature: the higher the temperature, the shorter the service life and, the lower the temperature, the longer the service life. Therefore, the service life can be extended by lowering the temperature of the Temperature Controller.
3. When two or more Temperature Controllers are mounted horizontally close to each other or vertically next to one another, the internal temperature will increase due to heat radiated by the Temperature Controllers and the service life will decrease. In such a case, use forced cooling by fans or other means of air ventilation to cool down the Temperature Controllers. When providing forced cooling, however, be careful not to cool down the terminals sections alone to avoid measurement errors.

## Measurement Accuracy

1. When extending or connecting the thermocouple lead wire, be sure to use compensating wires that match the thermocouple types.
2. When extending or connecting the lead wire of the platinum resistance thermometer, be sure to use wires that have low resistance and keep the resistance of the three lead wires the same.
3. Mount the product so that it is horizontally level.
4. If the measurement accuracy is low, check to see if input shift has been set correctly.

## Waterproofing

The degree of protection is as shown below. Sections without any specification on their degree of protection or those with IP□0 are not waterproof.

E5CZ E5AZ E5EZ	Front panel: IP66 (indoor use) Rear case: IP20, Terminal section: IP00
E5CZ-U	Front panel: Equivalent to IP50, rear case: IP20, Terminals: IP00

## Precautions for Operation

1. It takes approximately 2 seconds for the outputs to turn ON from after the power supply is turned ON. Due consideration must be given to this time when incorporating Temperature Controllers in a sequence circuit.
2. When using self-tuning, turn ON power for the load (e.g., heater) at the same time as or before supplying power to the Temperature Controller. If power is turned ON for the Temperature Controller before turning ON power for the load, self-tuning will not be performed properly and optimum control will not be achieved.
3. When starting operation after the Temperature Controller has warmed up, turn OFF the power and then turn it ON again at the same time as turning ON power for the load. (Instead of turning the Temperature Controller OFF and ON again, switching from STOP mode to RUN mode can also be used.)
4. Avoid using the Controller in places near a radio, television set, or wireless installing. These devices can cause radio disturbances which adversely affect the performance of the Controller.

## USB-Serial Conversion Cable

1. The disk that is included with the Conversion Cable is designed for a computer CD-ROM driver. Never attempt to play the disk in a general-purpose audio player.
2. Do not connect or disconnect the Conversion Cable connector repeatedly over a short period of time. The computer may malfunction.
3. After connecting the Conversion Cable to the computer, check the COM port number before starting communications. The computer requires time to recognize the cable connection. This delay does not indicate failure.
4. Do not connect the Conversion Cable through a USB hub. Doing so may damage the Conversion Cable.
5. Do not use an extension cable to extend the Conversion Cable length when connecting to the computer. Doing so may damage the Conversion Cable.
6. For models with communications, the same port is used by the Setting Tool port and for communications via the communications terminals. Do not use communications via the communications terminals when using the Setting Tool port.

## Mounting

### Mounting to the Panel

#### E5CZ

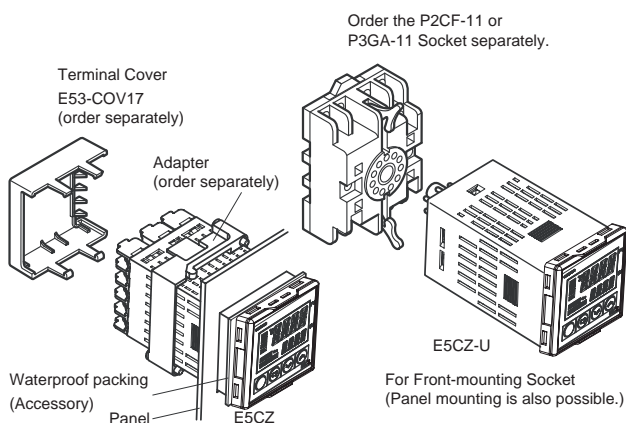

1. For waterproof mounting, waterproof packing must be installed on the Controller. Waterproofing is not possible when group mounting Controllers. Waterproof packing is not necessary when there is no need for the waterproof function. There is no waterproof function for the E5CZ-U.
2. Insert the E5CZ/E5CZ-U into the mounting hole in the panel.
3. Push the adapter from the terminals up to the panel, and temporarily fasten the E5CZ/E5CZ-U.
4. Tighten the two fastening screws on the adapter. Alternately tighten the two screws little by little to maintain a balance. Tighten the screws to a torque of 0.29 to 0.39 N·m.

#### E5EZ/E5AZ

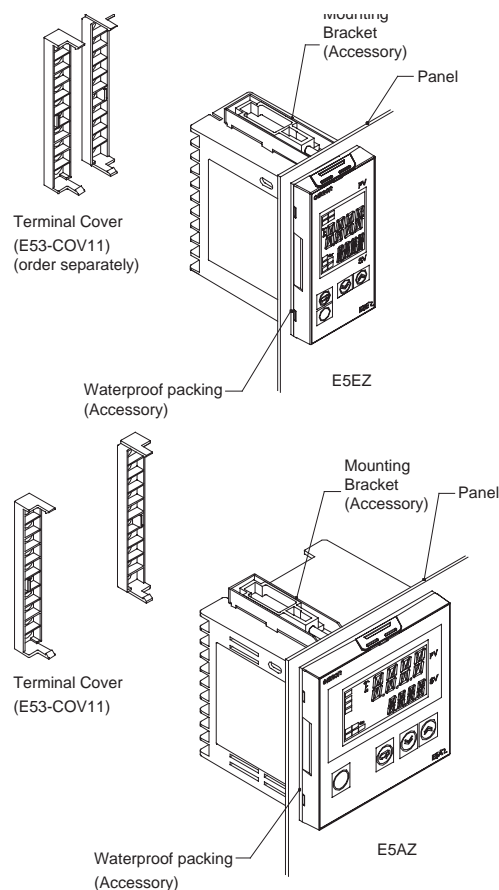

1. For waterproof mounting, waterproof packing must be installed on the Controller. Waterproofing is not possible when group mounting Controllers. Waterproof packing is not necessary when there is no need for the waterproof function.
2. Insert the E5AZ/E5EZ into the square mounting hole in the panel (thickness: 1 to 8 mm). Attach the Mounting Brackets provided with the product to the mounting grooves on the top and bottom surfaces of the rear case.
3. Use a ratchet to alternately tighten the screws on the top and bottom Mounting Brackets little by little to maintain balance, until the ratchet turns freely.

### Mounting the Terminal Cover

For the E5CZ, make sure the "UP" characters on the Cover are in the correct position and insert the Cover into the holes at the top and bottom.

For the E5EZ or E5AZ, fit the E53-COV11 Terminal Cover over the upper hook. Mount it in the direction shown in the above diagram. If the Terminal Cover is mounted in the opposite direction, proper mounting of the fixtures may not be possible.

## Removing the Temperature Controller from the Case

### E5CZ/EZ/AZ

The Temperature Controller can be removed from the case to perform maintenance without removing the terminal leads. This is possible for only the E5CZ, E5AZ, and E5EZ, and not for the E5CZ-U. Check the specifications of the case and Temperature Controller before removing the Temperature Controller from the case.

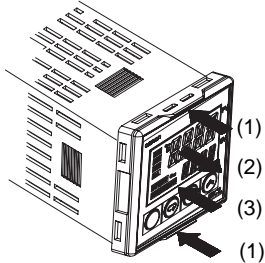

E5CZ/CZ-U

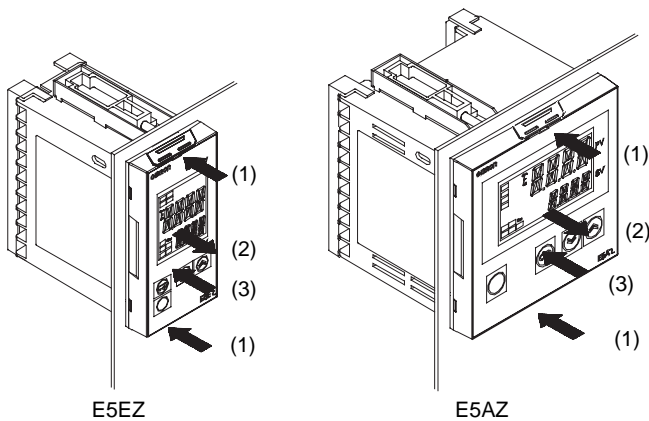
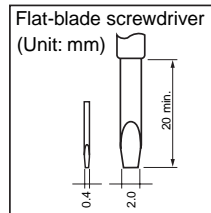

E5EZ

E5AZ

1. Insert a flat-blade screwdriver into the two tool insertion holes (one on the top and one on the bottom) to release the hooks.
2. Insert the flat-blade screwdriver in the gap between the front panel and rear case, and pull out the front panel slightly. Hold the top and bottom of the front panel and carefully pull it out toward you, without applying unnecessary force.
3. When inserting the E5CZ/EZ/AZ, check to make sure that the sealing rubber is in place and push the E5CZ/EZ/AZ toward the rear case until it snaps into position. While pushing the E5CZ/EZ/AZ into place, push down on the hooks on the top and bottom surfaces of the rear case so that the hooks are securely locked in place. Be sure that electronic components do not come into contact with the case.

## Precautions when Wiring

- Separate input leads and power lines in order to prevent external noise.
- Use wires with a gage of AWG24 (cross-sectional area: 0.205 mm<sup>2</sup>) to AWG14 (cross-sectional area: 2.081 mm<sup>2</sup>) twisted-pair cable (stripping length: 5 to 6 mm).
- Use crimp terminals when wiring the terminals.
- Tighten the terminal screws to a torque of 0.74 to 0.90 N·m.
- Use the following types of crimp terminals for M3.5 screws.



- Do not remove the terminal block. Doing so may result in malfunction or failure.

# E5EZ-PRR

## A position proportional control model for the E5EZ-PRR series

- Depth of only 78 mm.
- Various temperature inputs (thermocouple, platinum resistance thermometer, infrared temperature sensor, voltage inputs) and analog inputs (current, voltage)
- Makes use of high-visibility LCD, with three lines of 4-digit display, for simplicity and clarity
- 3 lines of display to observe PV/ SV/ MV (valve open percentage), clearly displaying the state of control (operations)
- Event input enables multi-SP selection and run/ stop function
- Alarm delay function
- Communications function
- Able to choose closed/floating control. In floating control, position proportional control can be performed without a potentiometer
- Equipped with a manual output function (equipped with an automatic/manual key)
- CE marking and UL/CSA certification

**Note:** Refer to Precautions on page 59.



48 × 96 × 78 (W × H × D)



## Model Number Structure

### Model Number Legend

E5EZ-PRR□□□□  
1 2 3 4 5 6

**1. Control method**

P: Valve control

**2. Control output 1**

R: Relay (OPEN)

**3. Control output 2**

R: Relay (CLOSE)

**4. Number of alarms**

Blank: Not available

2: Two alarms

**5. Option**

Blank: Not available

01: RS-232C

03: RS-485

B: 2 event inputs

**6. Input Type**

T: Temperature

L: Analog input (current, voltage)

## Ordering Information

Size	Power supply voltage	Input type	Control method	Number of alarms	Communications function	Event input	Model			
1/8DIN 48 × 96 × 78 (W × H × D)	100 to 240 VAC	Temperature Input Type	Valve Control	None	None	None	E5EZ-PRRT			
				2		None	2 points	E5EZ-PRR2T		
						RS-232C	None	E5EZ-PRR2BT		
				2		RS-485		None	E5EZ-PRR201T	
						None	None	None	E5EZ-PRR203T	
				2		None			2 points	E5EZ-PRRL
		None			None	None		E5EZ-PRR2L		
		2		RS-232C				2 points	E5EZ-PRR2BL	
				RS-485		None		None	E5EZ-PRR201L	

### Accessories (Order Separately)

#### Unit Label

Model	Y92S-L1
-------	---------

#### Terminal Cover

Connectable models	Terminal block models
Model	E53-COV18

## Input Range

### Thermocouples / Platinum Resistance Thermometer

Input type	Platinum resistance thermometer		Thermocouple													ES1B Infrared temperature sensor				Analog input				
	Name	Pt100	JPt100	K	J	T	E	L	U	N	R	S	B	10 to 70°C	60 to 120°C	115 to 165°C	140 to 260°C	0 to 50 mV						
Temperature range (°C)	1800																		Usable in the following ranges by scaling: -1999 to 9999 or -199.9 to 999.9					
	1700																							
	1600																							
	1500																							
	1400																							
	1300																							
	1200																							
	1100																							
	1000																							
	900																							
	800																							
	700																							
	600																							
	500																							
	400																							
	300																							
	200																							
	100																							
	0																							
	-100																							
	-200																							
Setting number	0	1	2	3	4	5	6	7	8	9	22	10	11	12	23	13	14	15	16	17	18	19	20	21

The applicable standards for each of the above input ranges are as follows:

K, J, T, E, N, R, S, B: JIS C1602-1995, IEC 584-1

L: Fe-CuNi, DIN 43710-1985

U: Cu-CuNi, DIN 43710-1985

JPt100: JIS C 1604-1989, JIS C 1606-1989

Pt100: JIS C 1604-1997 IEC 751

### Models with Analog Inputs

Parameters	Current [mA]		Voltage [V]		
		4 to 20	0 to 20	1 to 5	0 to 5
Set value	0	1	2	3	4
Minimum Setting Unit (Set Value, Alarm)	(Scaling, according to the location of the decimal point)				

■ indicates factory settings.

### Optional Functions

Type	Performance
RS-232C	Baud Rate: 1200/2400/4800/9600/19200bps
RS-485	
Event Input	ON: Maximum of 1 KΩ OFF: Minimum of 100 KΩ

## Specifications

### Ratings

<b>Power supply voltage</b>		100 to 240 VAC, 50/60 Hz
<b>Operating voltage range</b>		85% to 110% of rated supply voltage
<b>Power consumption</b>		10 VA (10 W)
<b>Sensor input</b>		Temperature input type Thermocouple: K, J, T, E, L, U, N, R, S, B Platinum resistance thermometer: Pt100, JPt100 Infrared temperature sensor: 10 to 70°C, 60 to 120°C, 115 to 165°C, 140 to 260°C Voltage input: 0 to 50 mV
		Analog (current, voltage) input type Current input: 4 to 20 mA, 0 to 20 mA Voltage input: 1 to 5 V, 0 to 5 V, 0 to 10 V
<b>Control output</b>	<b>Relay output (OUT1,OUT2)</b>	SPST-NO, 250 VAC 1A (resistive load) Electrical life: 100,000 operations, minimum applicable load: 5 V, 10 mA
<b>Potentiometer input</b>		100 Ω to 2.5 KΩ
<b>Alarm output</b>		SPST-NO, 250 VAC 2 A (resistive load) Electrical life: 100,000 operations, minimum applicable load: 5 V, 10 mA.
<b>Event input</b>	<b>Contact input</b>	ON: 1 kΩ max., OFF: 100 kΩ min.
	<b>Non-contact input</b>	ON: Residual voltage: 1.5 V max., OFF: Leakage current: 0.1 mA max.
		Outflow current: Approx. 7 mA per point
<b>Control method</b>		2-PID control
<b>Setting method</b>		Digital setting using front panel keys
<b>Indication method</b>		7-segment digital display and single-lighting indicators Character height: PV: 9 mm; SV: 7 mm; MV: 6.8 mm
<b>Other functions</b>		According to controller model
<b>Ambient operating temperature</b>		-10 to 55°C (with no icing or condensation)
<b>Ambient operating humidity</b>		25% to 85%
<b>Storage temperature</b>		-25 to 65°C (with no icing or condensation)

### Communications Specifications

<b>Transmission line connection</b>	RS-485: Multidrop RS-232C:Point-to-point
<b>Communications method (See note 1.)</b>	RS-485 (two-wire, half duplex)/RS-232C
<b>Synchronization method</b>	Start-stop synchronization
<b>Baud rate</b>	1,200/2,400/4,800/9,600/19,200 bps
<b>Communications code</b>	ASCII
<b>Data length (See note 2.)</b>	7 or 8 bits
<b>Stop bits (See note 2.)</b>	1 or 2 bits
<b>Error detection</b>	Vertical parity (none, even, odd) Block check character (BCC)
<b>Flow control</b>	Not available
<b>Interface</b>	RS-485/RS-232C
<b>Retry function</b>	Not available

# E5EZ-PRR

## Specifications

### Characteristics

<b>Indication accuracy</b>	Thermocouple: ( $\pm 0.5\%$ of indicated value or $\pm 1^\circ\text{C}$ , whichever is greater) $\pm 1$ digit max. (See note 1.) Platinum resistance thermometer: ( $\pm 0.5\%$ of indicated value or $\pm 1^\circ\text{C}$ , whichever is greater) $\pm 1$ digit max. Analog Input: $\pm 0.5\%$ FS $\pm 1$ digit max. Potentiometer Input: $\pm 5\%$ FS $\pm 1$ digit max.
<b>Influence of temperature</b> (See note 2.)	R, S, and B thermocouple inputs: ( $\pm 1\%$ of PV or $\pm 10^\circ\text{C}$ , whichever is greater) $\pm 1$ digit max.
<b>Influence of voltage</b> (See note 2.)	Other thermocouple inputs: ( $\pm 1\%$ of PV or $\pm 4^\circ\text{C}$ , whichever is greater) $\pm 1$ digit max. * $\pm 10^\circ\text{C}$ for $-100^\circ\text{C}$ or less for K sensors Platinum resistance thermometer inputs: ( $\pm 1\%$ of PV or $\pm 2^\circ\text{C}$ , whichever is greater) $\pm 1$ digit max. Analog inputs: ( $\pm 1\%$ of FS) $\pm 1$ digit max.
<b>Proportional band (P)</b>	0.1 to 999.9 EU (in units of 0.1 EU)
<b>Integral time (I)</b>	0 to 3999 s (in units of 1 s) With floating control, 1 to 3999 s
<b>Derivative time (D)</b>	0 to 3999 s (in units of 1 s)
<b>Control period</b>	1 to 99 s (in units of 1 s)
<b>Manual reset value</b>	0.0% to 100.0% (in units of 0.1%)
<b>Alarm setting range</b>	-1999 to 9999 (decimal point position depends on input type)
<b>Sampling period</b>	500 ms
<b>Insulation resistance</b>	20 M $\Omega$ min. (at 500 VDC)
<b>Dielectric strength</b>	2000 VAC, 50 or 60 Hz for 1min (between terminals of different charge)
<b>Vibration resistance</b>	10 to 55 Hz, 20 m/s <sup>2</sup> for 10min each in X, Y, and Z directions
<b>Shock resistance</b>	100 m/s <sup>2</sup> , 3 times each in X, Y, and Z directions
<b>Weight</b>	Approx. 260 g
<b>Memory protection</b>	EEPROM (non-volatile memory) (number of writes: 100,000 operations)
<b>EMC</b>	Emission enclosure: EN55011 (GB/T 6113.1, 2) 1 group, type A Emission AC mains: EN55011 (GB/T 6113.1, 2) 1 group, type A (See note 2.) Immunity ESD: IEC61000-4-2 (GB/T 17626.2) 4 kV contact discharge (series 2) 6 kV air discharge (series 3)  Immunity RF interference: IEC61000-4-3 (GB/T 17626.3): 10 V/m, 80 MHz-1 GHz (series) Immunity-conducted disturbance: EC61000-4-6 (GB/T 17626.6): 3 V(0.15-80 MHz) (series 3) Surges (shocks): IEC61000-4-5 (GB/T 17626.5): 2 kV power supply line (series 3) 1 kV I/O signal line (series 4)
<b>Approved standards</b>	UL61010C-1, CSA C22.2 No.1010.1
<b>Conformed standards</b>	EN61326, EN61010-1 (IEC61010-1)

**Note:** 1. The indication accuracy of K thermocouples in the -200 to 1300°C range, T and N thermocouples at a temperature of -100°C max., and U and L thermocouples at any temperature is  $\pm 2^\circ\text{C} \pm 1$  digit maximum. The indication accuracy of the B thermocouple at a temperature of 400°C max. is not specified. The indication accuracy of the R and S thermocouples at a temperature of 200°C max. is  $\pm 3^\circ\text{C} \pm 1$  digit max.

2. For E5EZ-PRR□03-model products, in order to satisfy the conduction and emission specifications of EN61326CLASS A, a magnetic ring (TDK: ZAT1730-0730) should be added to the communications line between the K3SC unit and the controller.



# Dimensions

**Note:** All units are in millimeters unless otherwise indicated.

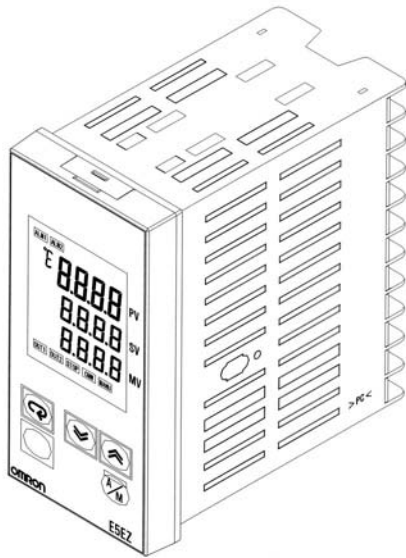

## Panel Cutout

Mounted Separately

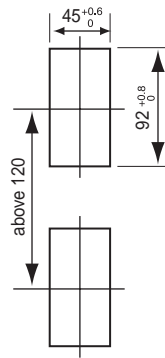

Group Mounted

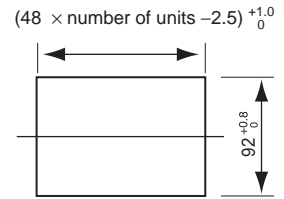

- Recommended panel thickness is 1 to 8 mm.
- Group mounting is not possible in the vertical direction. (Maintain the specified mounting space between Controllers.)
- When two or more Controllers are mounted, make sure that the surrounding temperature does not exceed the allowable operating temperature specified in the specifications.

## Package Content

- 1 Temperature Gauge
- 2 Metallic Components For Installation
- 1 Operating Manual
- 1 Quality Certificate

During removal, please use a screwdriver to remove the clips on the top and bottom of the front covering panel, and then remove the temperature gauge's front panel.

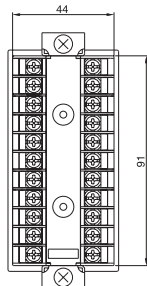
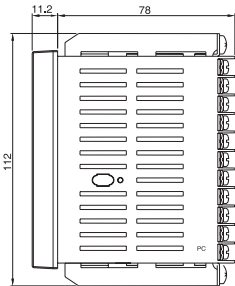

## Accessories

### Unit Labels (Order Separately)

Y92S-L1 Type

UNIT LABEL				
mV	V	mA	A	kW
mm	cm	m	km	g
kg	m <sup>3</sup>	ℓ	°C	°F
K	%RH	%	ℓ/s	ℓ/min
ℓ/h	m <sup>3</sup> /s	m <sup>3</sup> /min	m <sup>3</sup> /h	kg/h
rpm	ppm	pH	kPa	mmHg
mmH <sub>2</sub> O	mH <sub>2</sub> O	bar	Torr	mmAq
kgf/cm <sup>2</sup>	g/cm <sup>2</sup>	kg/cm <sup>2</sup>	kg/cm <sup>2</sup> G	kgf/cm <sup>2</sup> G
TAG No.		TAG No.		

### Terminal Covers (Order Separately)

E53-COV18 (Available only for E5EZ-PRR)

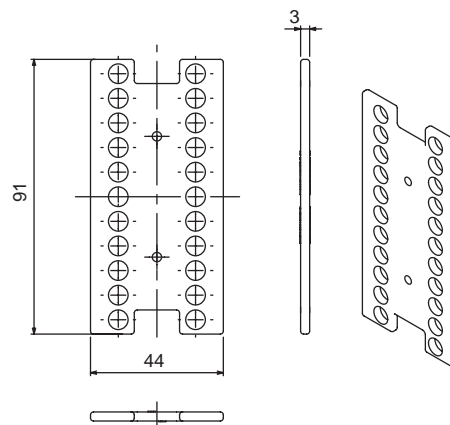

# E5EZ-PRR

## Wiring Terminals

- Standard insulation is applied to the temperature gauge's I/O sections. If reinforced insulation is required, connect the input and output terminals to a device without any exposed current-carrying parts, or to a device with standard insulation suitable for the maximum operation voltage of the power supply I/O section.
- For E5EZ-PRR□03-model products, in order to satisfy the conduction and emission specifications of EN61326CLASSA, a magnetic ring (TDK: ZAT1730-0730) should be added to the communications line between the K3SC unit and the controller.

### E5EZ-PRR

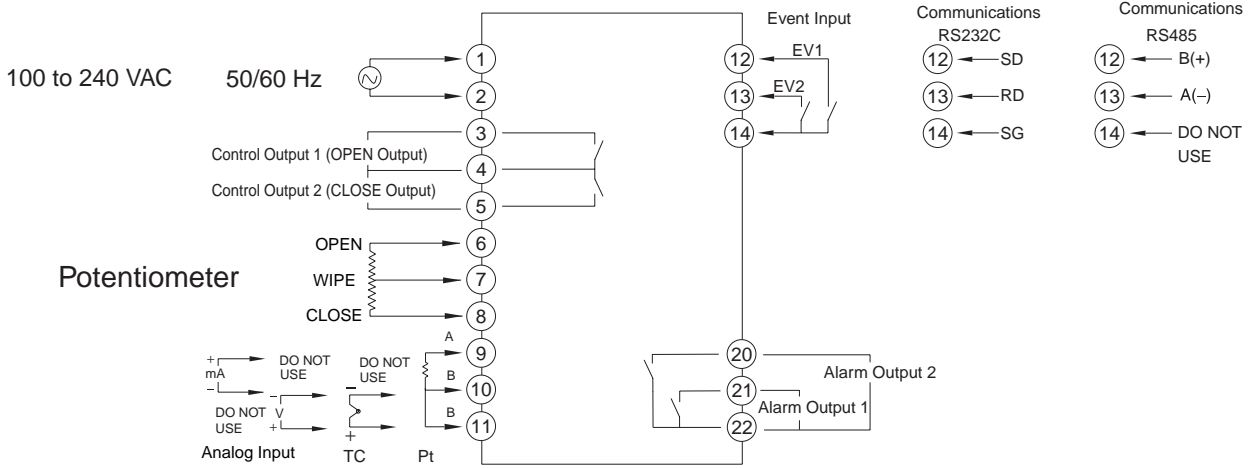

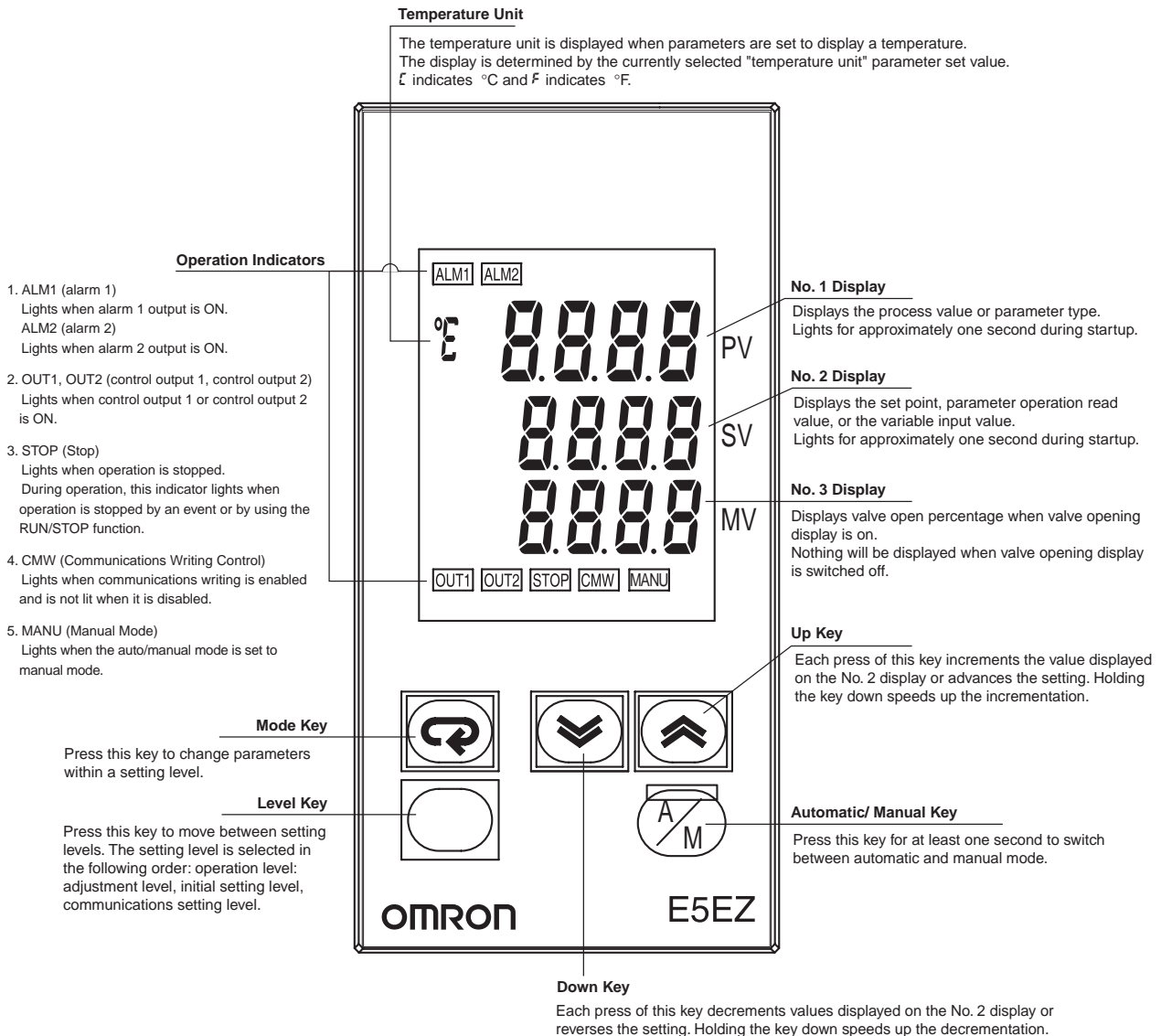

## Nomenclature

### E5EZ-PRR







# Operation

Initial hardware setup, including the sensor input type, alarm types, control periods, and other settings is done using parameter displays. The  and  keys are used to switch between parameters, and the amount of time that you press the keys determines which parameter you move to. Two typical examples are described as follows.

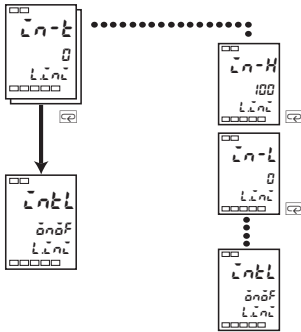

## Explanation of Examples

### Changing Parameters



 A  image means that there are parameters. Continue pressing the  key to change parameters until you reach the intended parameter.

### Changing Numbers

 Numeric data and selections in each screen can be changed by using the  and  keys.

## Typical Example 1

Input Type : 5K thermocouple -200°C to 1300°C  
 Control Method : PID Control  
 Alarm 1 Type : 2 upper limit (deviation)  
 Alarm Value 1 : 20°C (deviation)  
 Set value : 100°C

### Setup Procedure

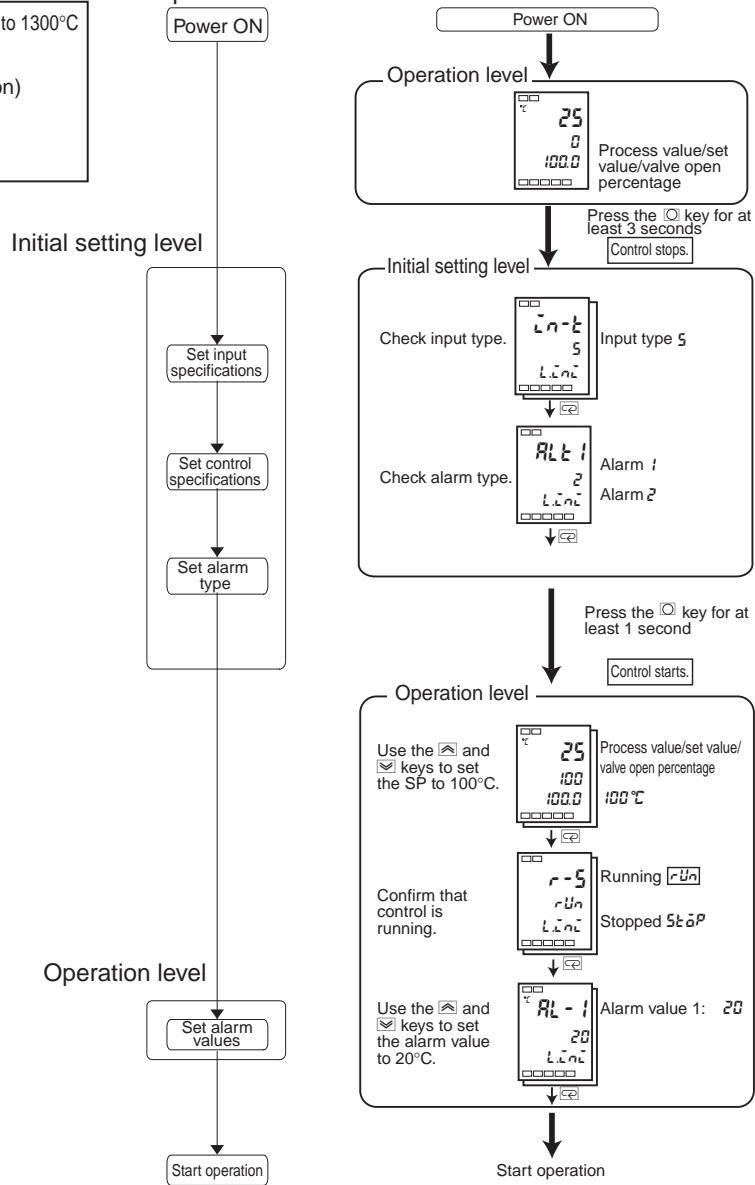

## Typical Example 2

Input type : 9T thermocouple -200°C to 400°C  
 Control method : PID control  
 Calculate PID constants by AT (auto-tuning).  
 Alarm 1 type : 2 upper limit  
 Set value : 150°C

### Setup Procedure

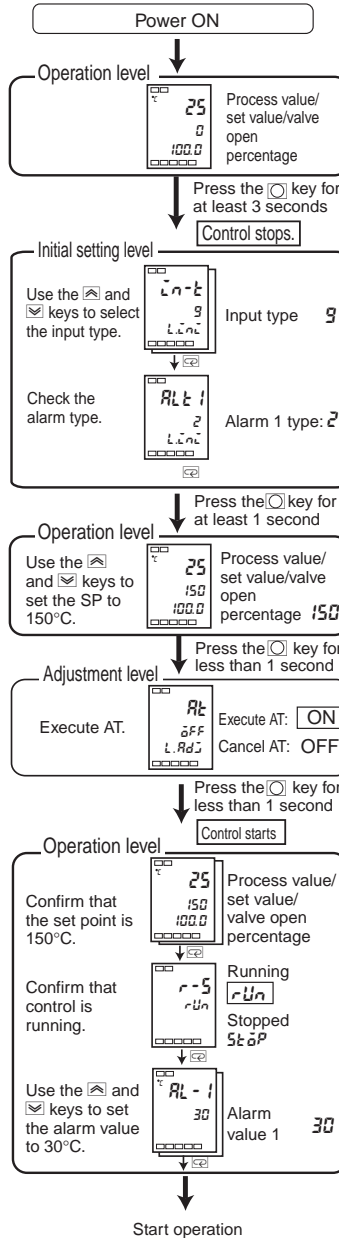
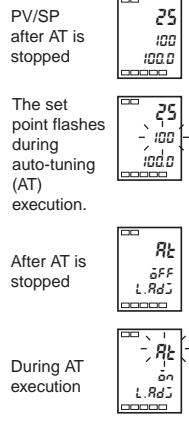
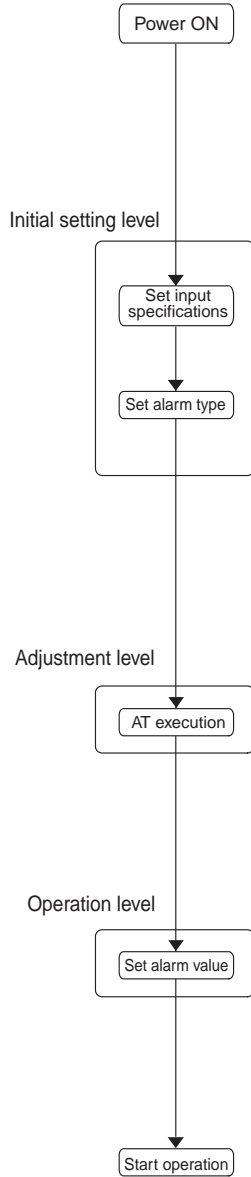

## Setting Level Configuration and Key Operations

Parameters are divided into groups, each called a “level.” Each of the set values (setup items) in these levels are called a “parameter.” The parameters on the E5EZ-PRR are divided into the following seven levels:

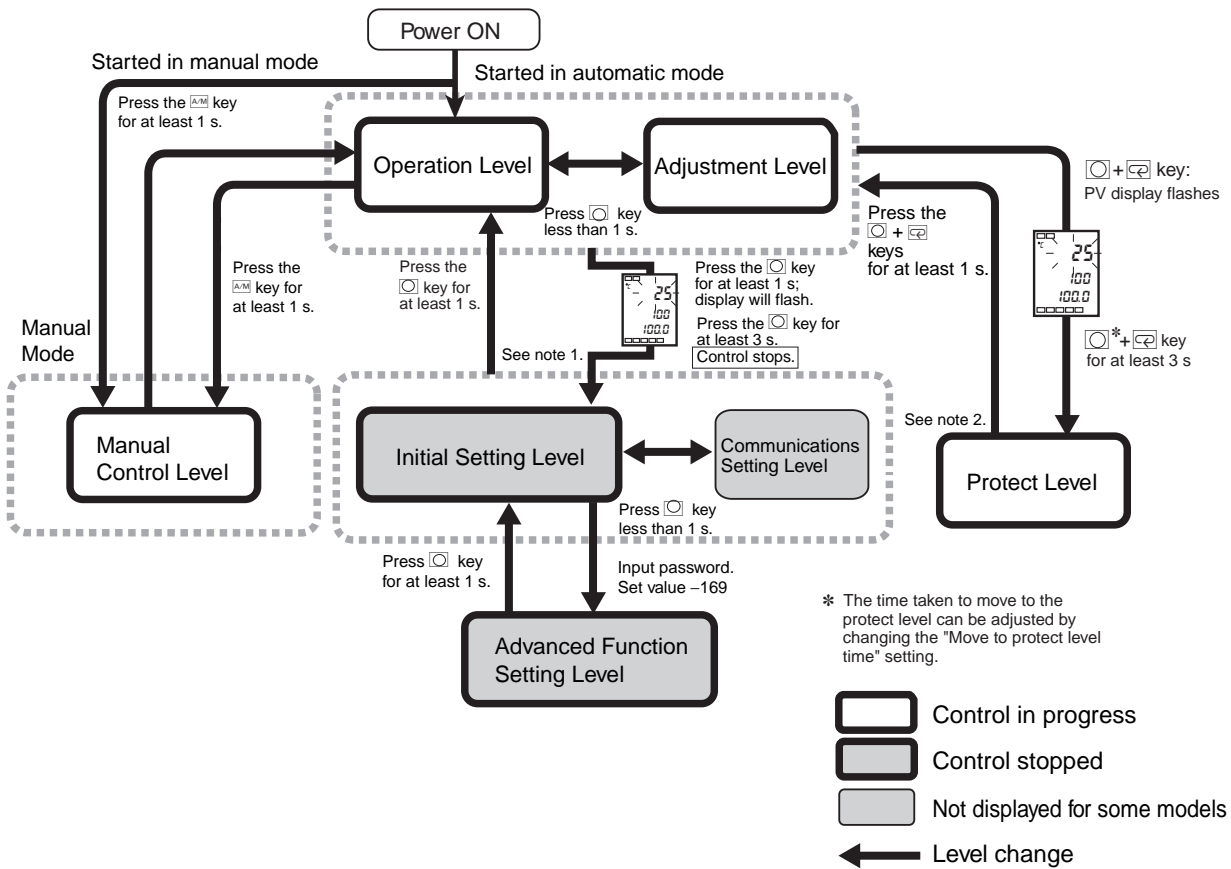

- Note:**
- When returning from the initial setting level to the operation level, the default in the operation level will be displayed.
  - When returning from the protect level to the operation level, the default in the operation level will be displayed.



	Control in Progress	Control Stopped
Protect level	Can be set.	---
Operation level	Can be set.	---
Adjustment level	Can be set.	---
Manual control level	Can be set.	---
Initial setting level	---	Can be set.
Advanced function setting level (See note.)	---	Can be set.
Communications setting level	---	Can be set.

**Note:** Set the parameters in the “initial setting/communications protect” under “protect level” to “0”, to activate advanced function setting level. Of these levels, the initial setting level, communications setting level, and advanced function setting level can be used only when control has stopped. Note that controller outputs are stopped when any of these three levels are selected. With the exception of operation level, the present level will be displayed. No. 3 display will show the following when settings are being changed:

No. 3 Display	Level name
Manual MV	Manual control level
L.P.r.t	Protect level
No display	Operation level
L.R.d.	Adjustment level
L.i.n.l	Initial setting level
L.c.o.n	Communications setting level
L.R.d.u	Advanced function setting level

## Descriptions of Each Level

### Protect Level

- To select this level, simultaneously press the  and  keys for at least 3 seconds. This level is to prevent unwanted or accidental modification of parameters. Protected levels will not be displayed, and so the parameters in that level cannot be modified.



### Operation Level

- This level is displayed when you turn the power ON. You can move to the protect level, initial setting level, manual control level and adjustment level from this level.
- Normally, select this level during operation. During operation, the process value and manipulated variable can be monitored, and the set points, alarm values, and upper- and lower-limit alarms can be monitored and modified.



### Adjustment Level

- To select this level, press the  key for less than one second.
- This level is for entering set values and offset values for control. This level contains parameters for setting the AT (auto-tuning), communications writing enable/disable, hysteresis, multi-SP, input shift values, heater burnout alarm (HBA) and PID constants. You can move to the top parameter of the operation level, initial setting level and protect level from here.

### Manual Control Level

- Pressing the  key under the operation/adjustment level for 1 second or more will activate manual mode, and switch to the manual control level. Under manual control, only "process value/set value/valve open percentage (manual MV)" can be displayed. Under the "process value/set value/valve open percentage (manual MV)" manual control level, pressing the  key for 1 second or more will switch to automatic mode, switch to the operation level, display the default in the level, and allow manual operation of MV in this mode.

### Initial Setting Level

- To access this level, press the  key for 3 or more seconds in the operation level or adjustment level. 1 second later, the PV display will blink. This level is used to indicate input type and select control method, control period, direct/reverse operation, and alarm type. You can move to the advanced function setting level or communications setting level from this level. Press the  key for at least 1 second to switch to the operation level. Press the  key less than 1 second to switch to the communications level.

### Advanced Function Setting Level

- To activate this level, set the parameters in the "initial setting/communications protect" under the "protect level" to "0" and then enter the password ("-169") in the initial setting level.
- The initial setting level can be accessed from this level.
- This level is for setting the automatic display return time, MV limiter, event input assignment, standby sequence, alarm hysteresis, and ST (self-tuning).

### Communications Setting Level

- To select this level, press the  key less than one second in the initial setting level. When the communications function is used, set the communications conditions in this level. Communicating with a personal computer (host computer) allows set points to be read and written, and manipulated variables to be monitored.

## Setting the Input Type

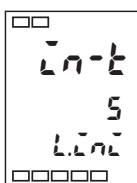

Input Types 5

The Controller supports four input types: platinum resistance thermometer, thermocouple, infrared temperature sensor, and analog inputs. Set the input type that matches the sensor that is used. In the product specifications, there are models with thermocouple/resistance thermometer inputs (universal input) and models with analog input. The settings differ depending on the model. Check to make sure which model you are using.

### List of Input Types

Input Type	Specifications	Set value	Input temperature setting range
Platinum Resistance Thermometer	Pt100	0	-200 to 850 (°C) / -300 to 1500 (°F)
		1	-199.9 to 500.0 (°C) / -199.9 to 900.0 (°F)
	2	0.0 to 100.0 (°C) / 0.0 to 210.0 (°F)	
	JPT100	3	-199.9 to 500.0 (°C) / -199.9 to 900.0 (°F)
4		0.0 to 100.0 (°C) / 0.0 to 210.0 (°F)	
Thermocouple	K	5	-200 to 1300 (°C) / -300 to 2300 (°F)
		6	-20.0 to 500.0 (°C) / 0.0 to 900.0 (°F)
	J	7	-100 to 850 (°C) / -100 to 1500 (°F)
		8	-20.0 to 400.0 (°C) / 0.0 to 750.0 (°F)
	T	9	-200 to 400 (°C) / -300 to 700 (°F)
		22	-199.9 to 400.0 (°C) / -199.9 to 700.0 (°F)
	E	10	0 to 600 (°C) / 0 to 1100 (°F)
	L	11	-100 to 850 (°C) / -100 to 1500 (°F)
	U	12	-200 to 400 (°C) / -300 to 700 (°F)
		23	-199.9 to 400.0 (°C) / -199.9 to 700.0 (°F)
	N	13	-200 to 1300 (°C) / -300 to 2300 (°F)
	R	14	0 to 1700 (°C) / 0 to 3000 (°F)
S	15	0 to 1700 (°C) / 0 to 3000 (°F)	
B	16	100 to 1800 (°C) / 300 to 3200 (°F)	
Infrared temperature sensor, ES1B	10°C to 70°C	17	0 to 90 (°C) / 0 to 190 (°F)
	60°C to 120°C	18	0 to 120 (°C) / 0 to 240 (°F)
	115°C to 165°C	19	0 to 165 (°C) / 0 to 320 (°F)
	140°C to 260°C	20	0 to 260 (°C) / 0 to 500 (°F)
Analog Input	0 to 50 mV	21	Either of the following ranges, by scaling: -1999 to 9999 or -199.9 to 999.9

The default is "5"

	Input Type	Specifications	Set value	Input temperature setting range
Analog Input Type	Current Input	4 to 20 mA	0	Use the following scales based on the range of measurements: -1999 to 9999 -199.9 to 999.9 -19.99 to 99.99 -1.999 to 9.999
		0 to 20 mA	1	
	Voltage Input	1 to 5 V	2	
		0 to 5 V	3	
		0 to 10 V	4	

The default is "0"

## Alarm Types

- Alarm outputs are determined by a combination of “alarm type,” “alarm value,” and “alarm hysteresis” alarm output conditions.
- This section describes the “alarm type,” “alarm value,” “upper-limit alarm” and “lower-limit alarm” parameters.

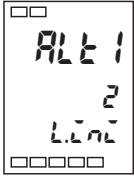

Alarm 1  
Type 2

Set values	Type	Alarm output operation	
		When X is positive	When X is negative
0	Alarm function OFF	Output OFF	
1 See note 1.	Upper-and lower-limit		See note 2.
2	Upper-limit		
3	Lower-limit		
4 See note 1.	Upper-and lower-limit range		See note 3.
5 See note 1.	Upper-and lower-limit with standby sequence		See note 4.
6	Upper-limit with standby sequence		
7	Lower-limit with standby sequence		
8	Absolute-value upper-limit		
9	Absolute-value lower-limit		
10	Absolute-value upper-limit with standby sequence		
11	Absolute-value lower-limit with standby sequence		

Note 1. Upper and lower-limit values can be set independently for each alarm type, and are expressed as L and H. The set values are 1, 4, and 5.

2. Set value: 1 (Upper-and lower-limit alarm)

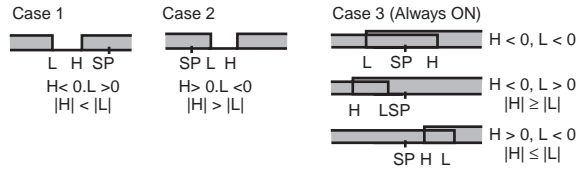

3. Set value: 4 (Upper-and lower-limit range)

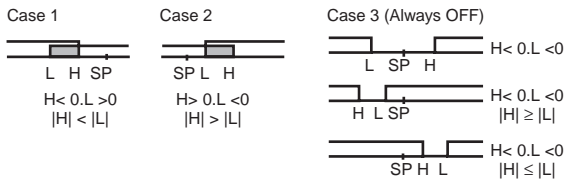

4. Set value: 5 (Upper-and lower-limit with standby sequence)

- The upper and lower limit alarms described above.
  - In cases 1 and 2, if there is significant overlap between the upper and lower limit values after hysteresis, the alarm will always be OFF.
- Examples of case 1 and 2: In case 3, under general conditions, the alarm is turned OFF.

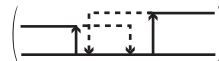

5. Set value: 5 (Upper-and lower-limit with standby sequence)

If there are any overlaps in the upper and lower limits for hysteresis, the alarm will always be OFF.

There are alarm types 1 to 2 (initial setting level), and settings should be made independently for each alarm.  
The default is 2: upper limit.



## Parameters

Parameters related to setting items for each level are marked in boxes in the following flowchart and brief descriptions are given as required. After finishing each setting, press the mode key to return to the beginning of each level.

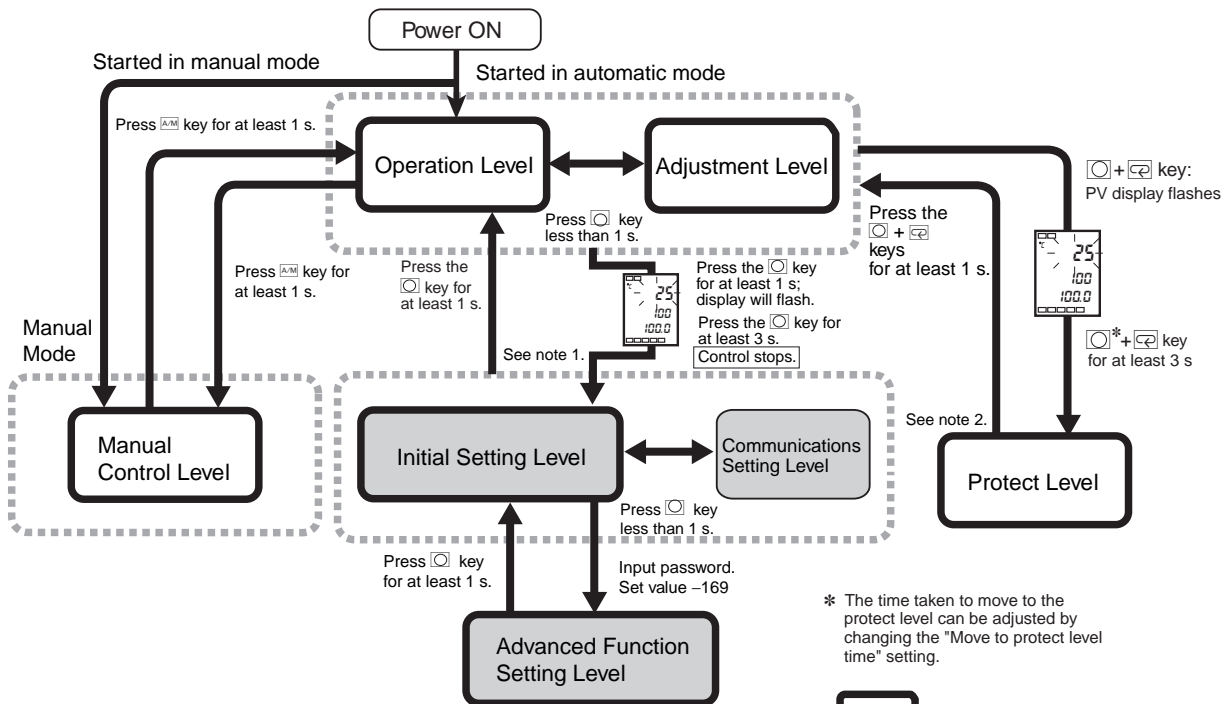

- Note 1:** When returning from the initial setting level to the operation level, the default in the operation level will be displayed.
- 2:** When returning from the protect level to the operation level, the default in the operation level will be displayed.

\* The time taken to move to the protect level can be adjusted by changing the "Move to protect level time" setting.

- Control in progress
- Control stopped
- Not displayed for some models
- Level change

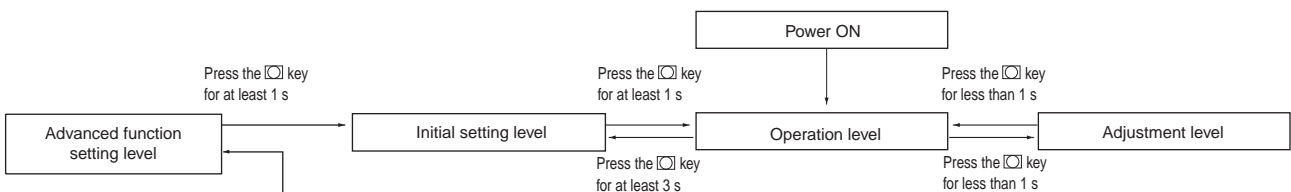
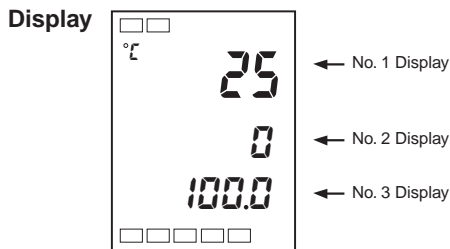

**Note:** To select the advanced function setting level, you must input the password (-169) in the initial setting level.

Parameter Flow

- In each level, if you press the mode key on the final parameter, you will return to the parameter at the top of the level.

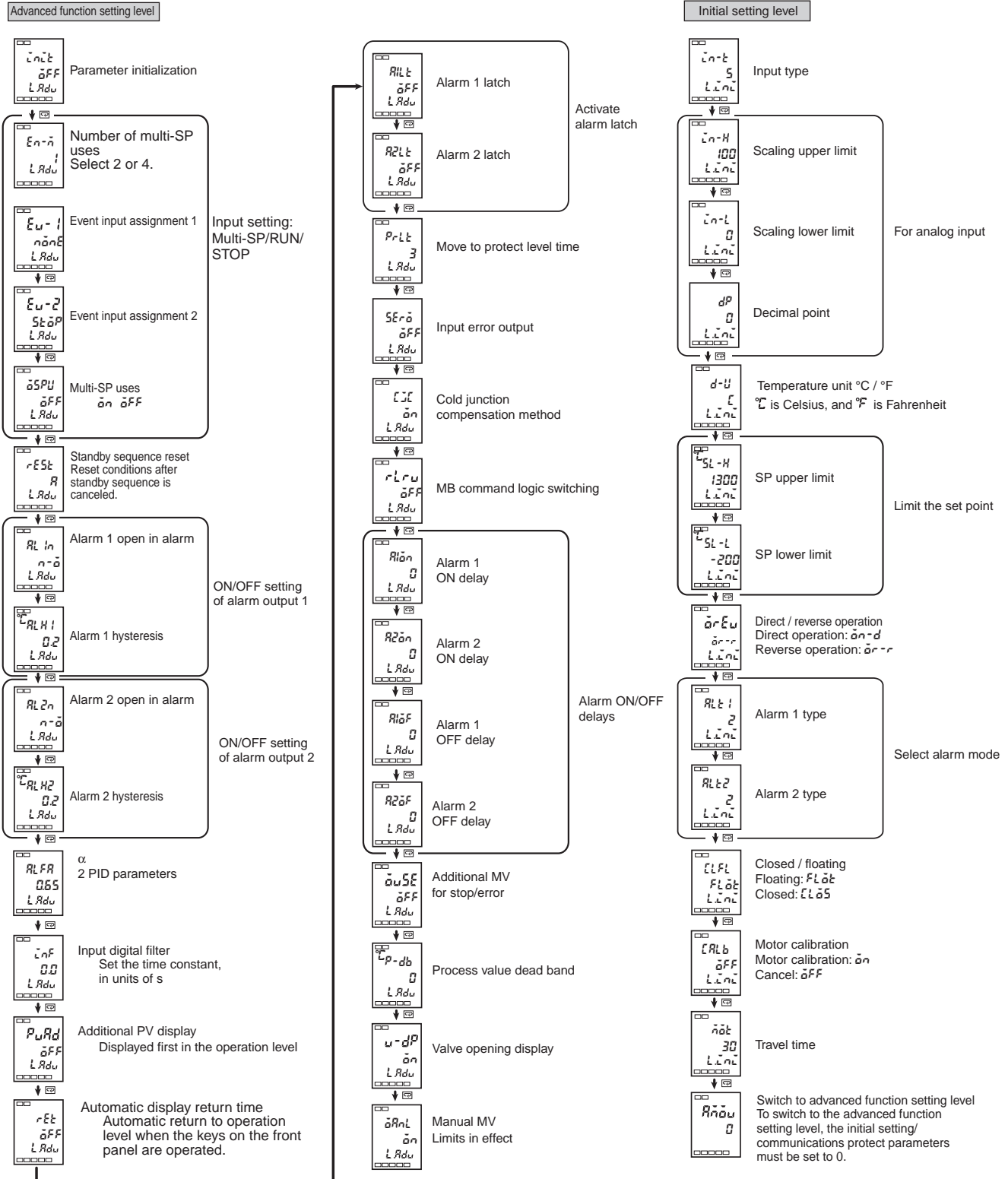

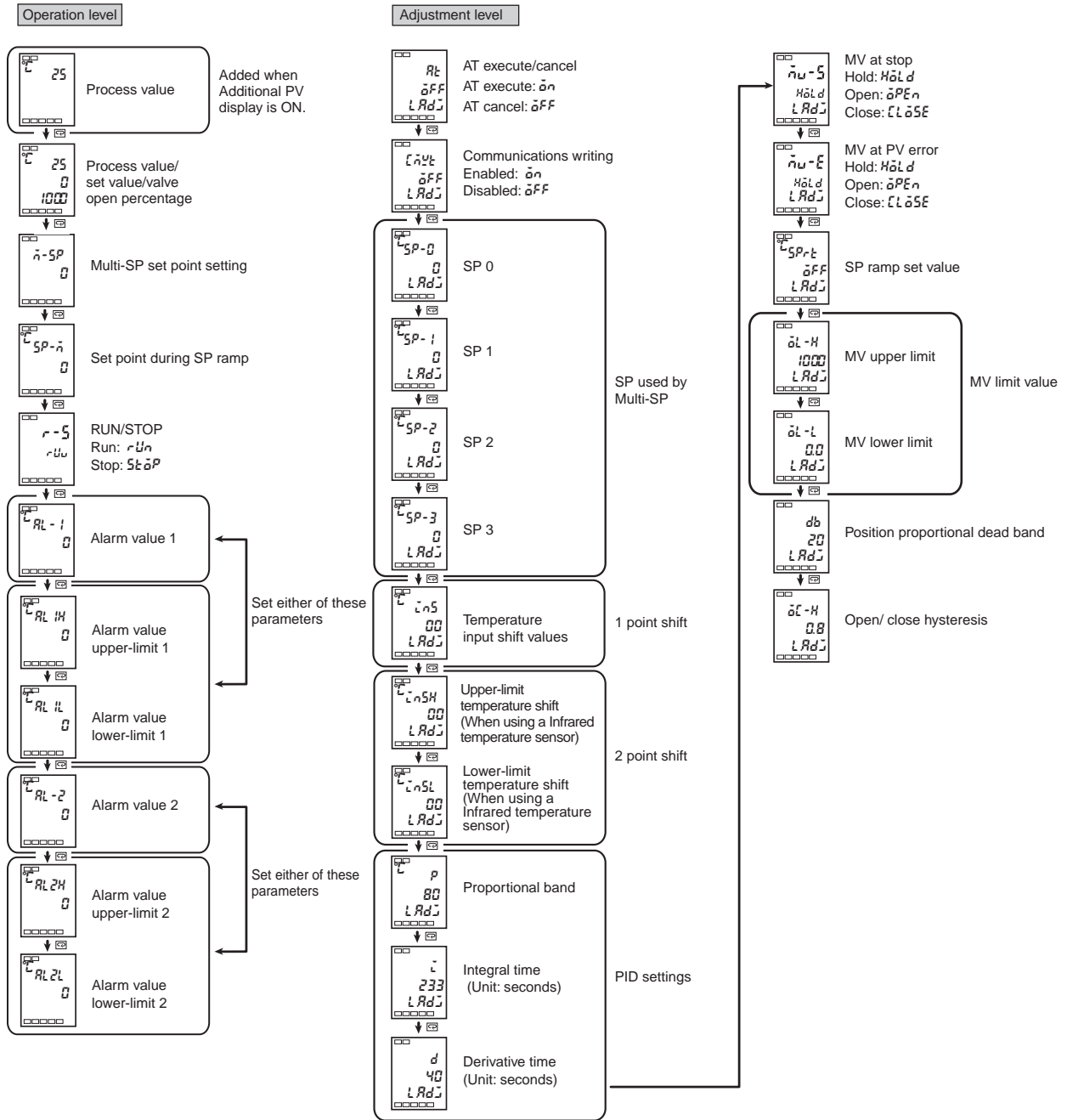

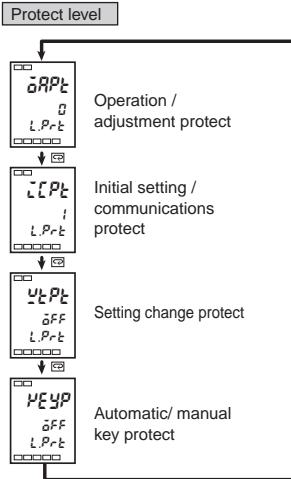

## Operation/ Adjustment Protect

The following table shows the relationship between set values and the range of protection.

Level		Set value			
		0	1	2	3
Operation level	PV	Can be displayed	Can be displayed	Can be displayed	Can be displayed
	PV/SP	Can be displayed and changed	Can be displayed and changed	Can be displayed and changed	Can be displayed
	Others	Can be displayed and changed	Can be displayed and changed	Cannot be displayed and moving to other levels is not possible	Cannot be displayed and moving to other levels is not possible
Adjustment level		Can be displayed and changed	Cannot be displayed and moving to other levels is not possible	Cannot be displayed and moving to other levels is not possible	Cannot be displayed and moving to other levels is not possible

- Parameters are not protected when the set value is set to 0.
- The default is 0.

## Initial Setting/ Communications Protect

This protect level restricts movement to the initial setting level, communications setting level, and advanced function setting level.

Set value	Initial setting level	Communications setting level	Advanced function setting level
0	Movement possible	Movement possible	Movement possible
1	Movement possible	Movement possible	Movement not possible
2	Movement not possible	Movement not possible	Movement not possible

- The default is 1.

## Setting Change Protect

This protect level restricts key operations.

Set value	Description
OFF	Settings can be changed using key operations.
ON	Settings cannot be changed using key operations. (The protect level settings, however, can be changed.)

- The default is OFF.

## Automatic/ Manual Key Protect

This protect level restricts key operations.

Set value	Description
OFF	Settings can be changed between automatic and manual mode using  key operations.
ON	Settings cannot be changed between automatic and manual mode using  key operations. (The protect level settings, however, can be changed.)

- The default is OFF.

## Setting Communications Parameters

- Each parameter is enabled when the power is reset.
- Match the communications specifications of the E5EZ-PRR and the host computer. If multiple devices are connected, ensure that the communications specifications for all devices in the system (except the Communications unit number) are the same.

Parameters	Symbol	Set (monitor) values	Settings	Default	Unit
Communications Unit number	U-nō	0 to 99		1	None
Baud rate	bP5	1.2, 2.4, 4.8, 9.6, 19.2	1.2, 2.4, 4.8, 9.6, 19.2	9.6	Kbps
Data length	LEn	7, 8		7	Length
Stop bits	Sbċt	1, 2		2	Bit
Parity	PrċtY	None, even, odd	nōnĒ, ĒuĒn, ādd	Even	None

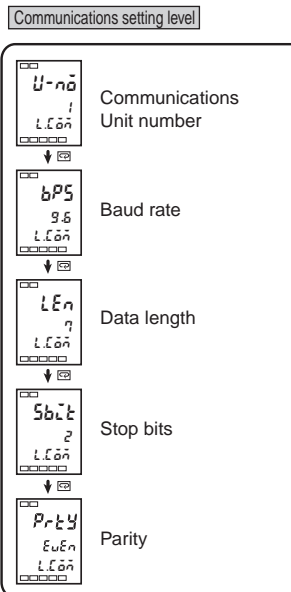

## Error Displays

When an error occurs, the error contents are shown on the No.1 display. This section describes how to check error codes on the display, and the actions to be taken to remedy the problems.



### Meaning

The input value has exceeded the input indication range(–1999 (–199.9) to 9999 (999.9)).

### Action

Check the wiring of inputs for miswiring, disconnections, and short-circuits and check the input type.

If no abnormality is found in the wiring and input type, turn the power OFF then back ON again.

If the display remains the same, the Controller must be replaced. If the display is restored, then the probable cause is electrical noise affecting the control system. Check for electrical noise.

### Operation at Error

After an error occurs, the error is displayed and the alarm outputs function as if the upper limit has been exceeded.

When the “input error output” parameter in the advanced function level is set to ON, the alarm 1 output turns ON whenever an input error occurs.

An error message is displayed when the PV or PV/SV/valve open percentage is displayed.



**Note.** When the manual MV, MV at stop, or MV at PV error is set, the control output corresponds to the set value.



### Meaning

Though this is not an error, it is displayed if the process value exceeds the display range when the control range is larger than the display range.

The display ranges are shown below.

- When less than –1,999 (–199.9) 
- When more than 9,999 (999.9) 

### Operation at Error

Control continues, allowing normal operation. The message is displayed when the PV or PV/SV/valve open percentage is displayed.

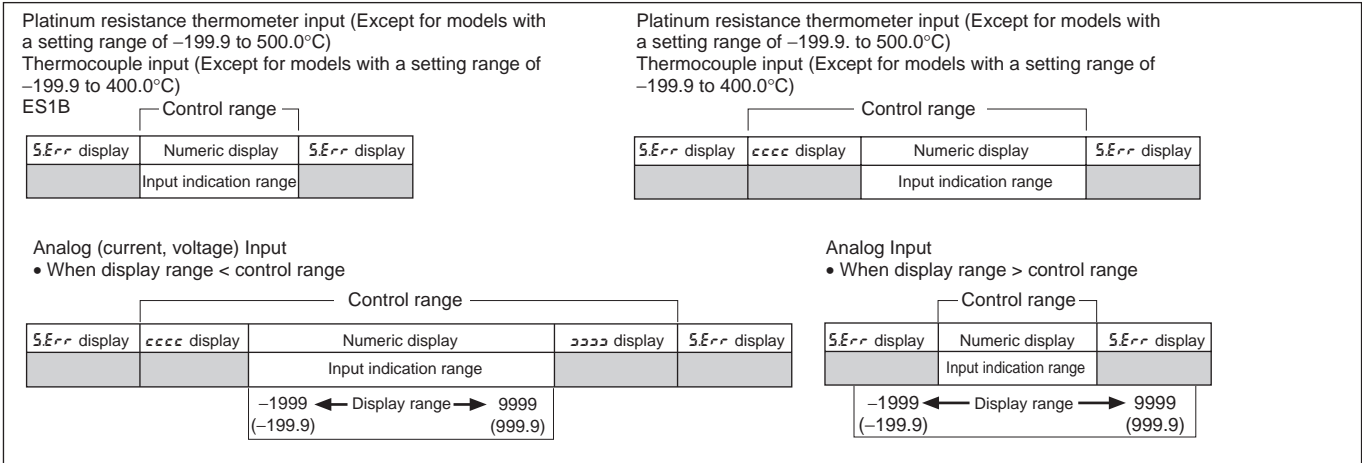

E!!!

## Memory Error

<b>Meaning</b>	Internal memory operation is in error.
<b>Action</b>	First, turn the power OFF then back ON again. If the display remains the same, the Controller must be repaired. If the display is restored, then the probable cause is electrical noise affecting the control system. Check for electrical noise.
<b>Operation at Error</b>	Control output and alarm output turn OFF.

- - - -

## Potentiometer Input Error

<b>Meaning</b>	Valve opening has exceeded its regular range of -10% to 110%.
<b>Action</b>	Check to see if there have been any wiring errors, burnouts, or short-circuits in the potentiometer. If there are no problems with the wiring, you can restart the power supply. If the display remains the same, the Controller must be replaced. If the display is restored, then the probable cause is interference which should be avoided.
<b>Operation at Error</b>	Control output will output MV based on the "MV during error" setting position. Alarm output will operate as normal.

Err

## Motor Calibration Error

<b>Meaning</b>	Motor calibration did not completely finish.
<b>Action</b>	After confirming the potentiometer and the wiring of the motor driving valve, perform motor calibration again.
<b>Operation at Error</b>	Control output and alarm output set to OFF.

## Position proportional control of a ceramic kiln

The control method whereby a potentiometer is used to read the amount of opening of a valve and then open or close the valve by means of an attached control motor is called position proportional control or on/off servo control.

### Application

To control a gas kiln using a position proportional control valve, select the control valve control type and configure the instrumentation as shown in the following example.

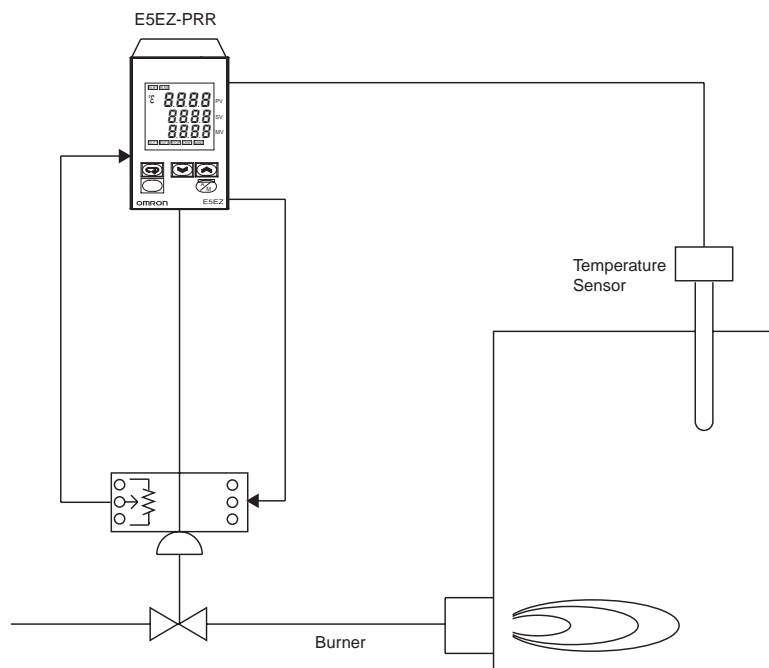
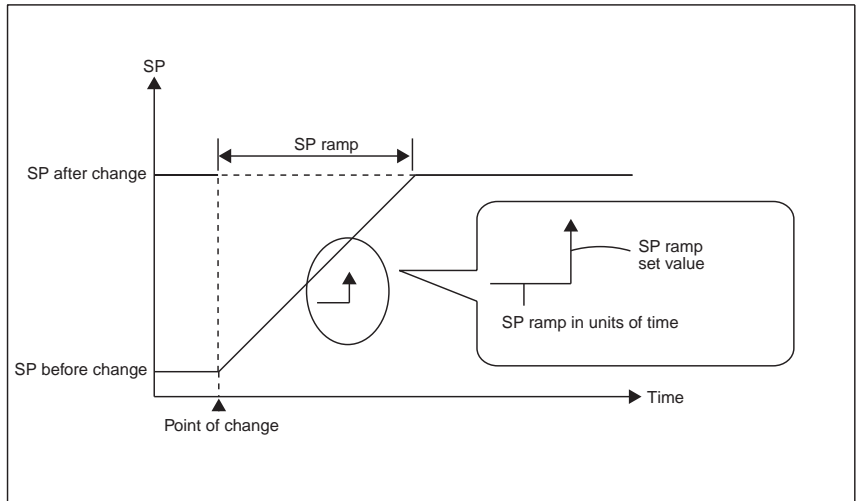
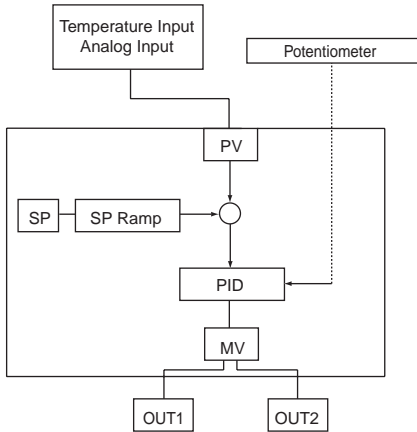

#### Note:

The SP ramp function allows limits to be placed on temperature changes which control the temperature within a specific range. This is useful for ceramic kiln, in which severe temperature changes may cause damage or corruption.

## Wiring

Input should be connected to terminals 9, 10, and 11 depending on input type. Connect the open side of the position proportional valve to OUT1, and connect the closed side to OUT2.

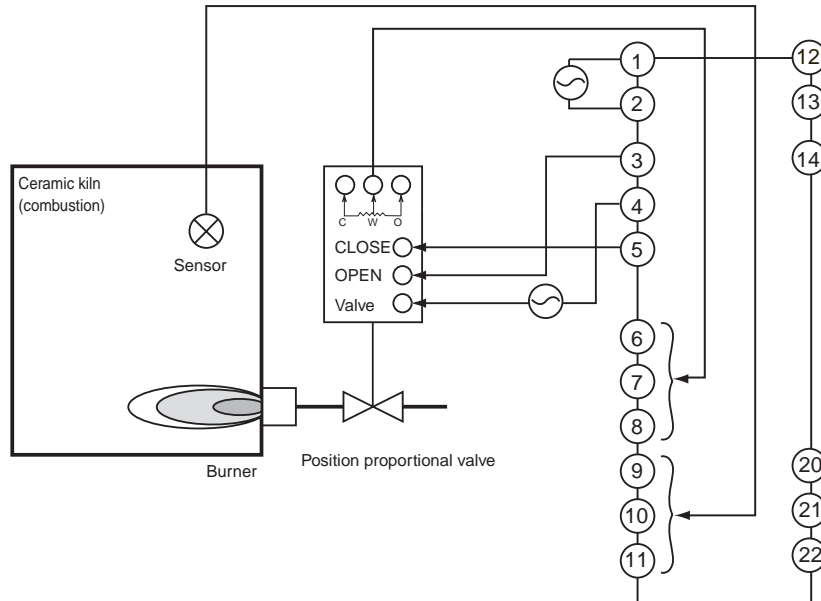

## Settings

Select the value control type and perform floating control using Position-proportional value with travel time\* of 45 seconds. Set SP ramp to change SP within a width of 10.0°C/minute.  
\*Time from completely open to completely close.

The related setting data and settings are as follows:

Direct/ reverse operation	= $\bar{a}r-r$ : Reverse operation (initial setting)
Closed/ floating	= $F\bar{L}\bar{a}t$ : Floating (initial setting)
Travel time	= 45 seconds
SP ramp set value	= "10"

The travel time and SP ramp set value are set in the following, and the initial settings are used for all other parameters.

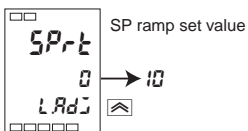
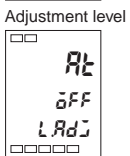
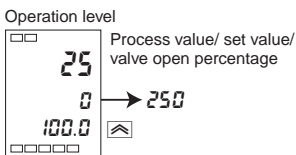
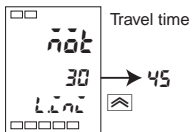
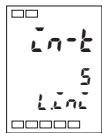

1. Press the  $\square$  key for at least 3 seconds to switch from the operation level to the initial setting level.
2. Press the  $\square$  key repeatedly to select " $\bar{a}r-r$ : Travel time". Press the  $\square$  key to set the value to "45".
3. Press the  $\square$  key for at least 1 second to return to the "operation level". When "present value/ set value/valve open percentage" is displayed, press the  $\square$  key to set the set value to "250".
4. Press the  $\square$  key for less than 1 second to switch from operation level to adjustment level.
5. Press the  $\square$  key repeatedly to select  $SP-r$ : SP ramp set value. Press the  $\square$  key, to set the value to "10".



## Adjustment

To adjust the PID constants, run AT.

## Settings for position proportional control

When position proportional control is selected, "Closed/Floating", "Motor calibration", "Travel time", "Position proportional dead band", "Open/Close hysteresis", "Operation at potentiometer input error", and "PV dead band" can be used.

### Closed/Floating

- Closed control  
Control whereby a potentiometer is connected to feed back the amount of opening of the valve.
- Floating control  
Control without feedback of the amount of opening of the valve. Control is possible without connecting a potentiometer.

### Motor calibration and travel time

Run "Motor calibration" when a potentiometer is connected for closed control or floating control that monitors the amount of valve opening.

This will also automatically set the "Travel time", which is the amount of time from when the valve is completely open to when the valve is completely closed.

When performing floating control without a potentiometer, it is necessary to manually set the "Travel time". Set the travel time to the amount of time from when the valve is completely open to when the valve is completely closed.

### Position proportional dead band and Open/Close hysteresis

The valve output hold interval (the duration of ON/OFF switching of open output and closed output) is set in "Position proportional dead band", and the hysteresis is set in "Open/Close hysteresis".

The relation to valve opening is shown below.

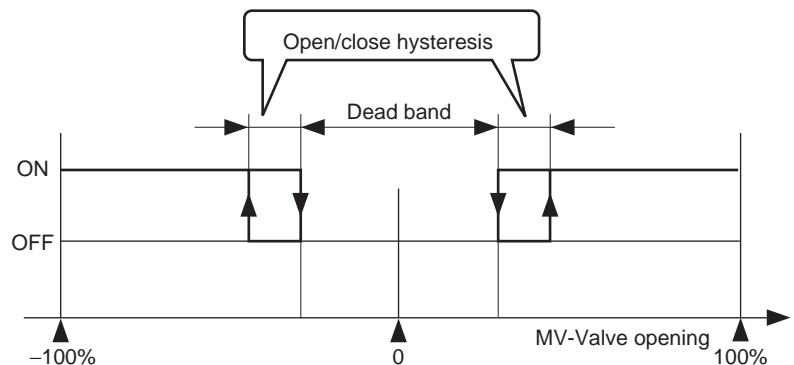

### PV dead band

When the present value is inside the PV dead band, this function is used to perform control for  $PV = SP$  and stop unnecessary output when the PV is close to the SP.

### Operation at potentiometer input error

Use this setting to select whether to stop control or switch to floating control and continue when a potentiometer error occurs during closed control.

## E5EZ-PRR

# Meeting all of your temperature control needs in a wide range of applications

## ES1B Infrared Temperature Sensor

Perform measurements with a contract-free sensor at minimal costs!



- Outputs electromotive forces identical to those of thermocouples, so that it can be connected directly to temperature controllers that generally use thermocouple input.
- 4 types of specifications. Can be used in all types of temperature measurements, from food products, packaging, and finished product, all the way to electrical engineering.
- 300 ms high-speed response (63% response time),  $\pm 1\%$  and PV's reenactment capabilities, ensuring high-accuracy temperature measurements.
- Compared to thermocouples, this product has the advantage of being resistant to aging, and can maintain steady real-time control.

**Note:** For more detailed information, please refer to other ES1B-related materials.

Shape, visual features	Specifications (temperature testing range)	Type
	10 to 70°C	ES1B
	60 to 120°C	
	115 to 165°C	
	140 to 260°C	

## ES1-L Series of Infrared Temperature Sensors

Able to measure temperatures without contact.

Damage-free, clean, and effective temperature management.

- Comes in two spot diameters: 3 mm dia. and 8 mm dia.
- Recreation accuracy kept within  $\pm 0.5^\circ\text{C}$ , with a response speed of 0.4 seconds (95%), along with high accuracy, realizing fast measurement.
- In addition to the original unit for use in medium temperatures (0 to  $+500^\circ\text{C}$ ), there are new models for use in medium to low temperatures ( $-50$  to  $+500^\circ\text{C}$ ) and high temperatures (0 to  $+1000^\circ\text{C}$ ).
- New long distance types enable measuring from distances of 500 mm and 1000 mm.
- By using a programmer (order separately), it is possible to monitor temperatures as well as make changes to the rate of emissions, switches between functions, and range of output.  
(The picture shows a programmer installed onto an ES1 unit.)



Type	Range of temperature measurements	Spot dimensions (See note 2.)	Type
For use with high temperatures	0 to $+1,000^\circ\text{C}$	35 mm dia. (distance of 1000 mm)	<b>ES1-LW100H</b>
		Below 40 mm dia. (distance of 500 mm)	<b>ES1-LW50H</b>
For use with medium to low temperatures	$-50$ to $+500^\circ\text{C}$ (See note 1.)	35 mm dia. (distance of 1000 mm)	<b>ES1-LW100</b>
		Below 40 mm dia. (distance of 500 mm)	<b>ES1-LW50</b>
For use with medium temperatures	0 to $+500^\circ\text{C}$	3 mm dia. (distance of 30 mm)	<b>ES1-LP3</b>
		8 mm dia. (distance of 100 mm)	<b>ES1-LP10</b>

**Note:** 1. At the time of shipment, the ES1-PRO model's range will have to be changed for 0 to  $+500^\circ\text{C}$ ,  $-50^\circ\text{C}$ .

2. This value is based on the energy restriction of 90%. The actual item must be at least 1.5 times larger.

**Note:** For more detailed information, please refer to other ES1-L-related materials.

## E52 Series of Temperature Sensors

Providing a diverse array of high-accuracy temperature sensors

- Used as a sensor for temperature controllers.
- Guaranteed that clients will be able to easily select the right model according to their temperature, location, and ambient operating conditions.
- Able to provide numerous models of various different categories, cases, lengths, and terminal shapes.
- Able to provide low-cost made-to-order models, as well as models for universal use.

**Note:** For more detailed information, please refer to other E52-related materials.



## Safety Precautions

### ⚠ CAUTION

Do not touch the terminals while power is being supplied. Doing so may occasionally result in minor injury due to electric shock.



Operate the Temperature Controller properly. Improper operation may cause minor or moderate injury or property damage.



Do not allow pieces of metal, wire clippings, or fine metallic shavings or filings from installation to enter the product. Doing so may occasionally result in electric shock, fire, or malfunction.



Do not use the product where subject to flammable or explosive gas. Otherwise, minor injury from explosion may occasionally occur.



Never disassemble, modify, or repair the product or touch any of the internal parts. Minor electric shock, fire, or malfunction may occasionally occur.



#### CAUTION - Risk of Fire and Electric Shock

- This product is UL listed as Open Type Process Control Equipment. It must be mounted in an enclosure that does not allow fire to escape externally.
- More than one disconnect switch may be required to de-energize the equipment before servicing the product.
- Signal inputs are SELV, limited energy. (See note 1.)
- Caution: To reduce the risk of fire or electric shock, do not interconnect the outputs of different Class 2 circuits. (See note 2.)



If the output relays are used past their life expectancy, contact fusing or burning may occasionally occur. Always consider the application conditions and use the output relays within their rated load and electrical life expectancy. The life expectancy of output relays varies considerably with the output load and switching conditions.



Loose screws may occasionally result in fire. Tighten terminal screws to the specified torque of 0.74 to 0.90 N·m.



Unexpected operation may result in equipment damage or accidents if the settings are not appropriate for the controlled system. Set the Temperature Controller as follows:



A malfunction in the Temperature Controller may occasionally make control operations impossible or prevent alarm outputs, resulting in property damage. To maintain safety in the event of malfunction of the Temperature Controller, take appropriate safety measures, such as installing a monitoring device on a separate line.



Be sure that the platinum resistance thermometer type and the input type set on the Temperature Controller are the same.



- Note:**
- A SELV circuit is one separated from the power supply with double insulation or reinforced insulation, that does not exceed 30 V r.m.s. and 42.4 V peak or 60 VDC.
  - A class 2 power supply is one tested and certified by UL as having the current and voltage of the secondary output restricted to specific levels.

## Precautions for Safe Use

Be sure to observe the following precautions to prevent operation failure, malfunction, or adverse affects on the performance and functions of the product. Not doing so may occasionally result in unexpected events.

- The product is designed for indoor use only. Do not use the product outdoors or in any of the following locations.
  - Places directly subject to heat radiated from heating equipment.
  - Places subject to splashing liquid or oil atmosphere.
  - Places subject to direct sunlight.
  - Places subject to dust or corrosive gas (in particular, sulfide gas and ammonia gas).
  - Places subject to intense temperature change.
  - Places subject to icing and condensation.
  - Places subject to vibration and large shocks.
- Use and store the product within the rated temperature and humidity ranges.
 

Group-mounting two or more Temperature Controllers, or mounting Temperature Controllers above each other may cause heat to build up inside the Temperature Controllers, which will shorten their service life. In such a case, use forced cooling by fans or other means of air ventilation to cool down the Temperature Controllers.
- To allow heat to escape, do not block the area around the product. Do not block the ventilation holes on the product.
- Use the specified size (M3.5, width of 7.2 mm or less) crimped terminals for wiring. To connect bare wires to the terminal block, use copper braided or solid wires with a gage of AWG24 to AWG14 (equal to a cross-sectional area of 0.205 to 2.081 mm<sup>2</sup>). (The stripping length is 5 to 6 mm.) Up to two wires of the same size and type, or two crimp terminals can be inserted into a single terminal.
- Be sure to wire properly with correct polarity of terminals. Do not wire any of the I/O terminals incorrectly.
- Do not wire the terminals that are not used.
- The voltage output (control output) is not electrically isolated from the internal circuits. When using a grounded temperature sensor, do not connect any of the control output terminals to ground. Otherwise unwanted current paths will cause measurement errors.
- To avoid inductive noise, keep the wiring for the Temperature Controller's terminal block away from power cables carrying high voltages or large currents. Also, do not wire power lines together with or parallel to Temperature Controller wiring. Using shielded cables and using separate conduits or ducts is recommended. Attach a surge suppressor or noise filter to peripheral devices that generate noise (in particular, motors, transformers, solenoids, magnetic coils or other equipment that have an inductance component).
 

When a noise filter is used at the power supply, first check the voltage or current, and attach the noise filter as close as possible to the temperature controller.

Allow as much space as possible between the Temperature Controller and devices that generate powerful high frequencies (high-frequency welders, high-frequency sewing machines, etc.) or surge.
- To reduce the risk of fire or electric shock, install the Temperature Controller in a controlled environment relatively free of contaminants.
- The outputs may turn OFF when shifting to certain levels. Take this into consideration when performing control.
- When turning OFF the power, use a switch or relay to ensure the voltage decreases immediately. Incorrect operation and data storage errors may occur if the voltage decreases slowly.
- Make sure that any Option Units are installed correctly. Do not remove the internal PCB when installing an Option Unit.
- When inserting the Temperature Controller into the case, do not force it into the case. Doing so will damage internal parts.
- The EEPROM has a limited write life. When overwriting data frequently, e.g., via communications, use RAM Mode.
- Use the product within the rated load and power supply.
- Use a switch, relay, or other contact so that the power supply voltage reaches the rated voltage within 2 seconds. If the applied voltage is increased gradually, the power supply may not be reset or malfunctions may occur.

17. When using PID operation (self-tuning), turn ON the power supply to the load (e.g., heater) at the same time or before turning the power supply to the Temperature Controller ON. If power is turned ON for the Temperature Controller before turning ON power supply to the load, self-tuning will not be performed properly and optimum control will not be achieved.
18. Design the system (e.g., control panel) to allow for the 2 seconds of delay required for the Temperature Controller's output to stabilize after the power is turned ON.
19. A switch or circuit breaker should be provided close to this unit. The switch or circuit breaker should be within easy reach of the operator, and must be marked as a disconnecting means for this unit.
20. Approximately 30 minutes is required for the correct temperature to be displayed after turning the power supply to the Temperature Controller ON. Turn the power supply ON at least 30 minutes prior to starting control operations.
21. When extending the thermocouple lead wires, always use compensating conductors suitable for the type of thermocouple. Do not extend the lead wires on a platinum resistance thermometer. Use only low-resistance wire (5  $\Omega$  max. per line) for lead wires and make sure that the resistance is the same for all three wires.
22. When drawing out the Temperature Controller from the case, do not apply force that would deform or alter the Temperature Controller.
23. When drawing out the Temperature Controller from the case to replace the Temperature Controller, check the status of the terminals. If corroded terminals are used, contact faults with the terminals may cause the temperature inside the Temperature Controller to increase, possibly resulting in fire. If the terminals are corroded, replace the rear case as well.
24. When drawing out the Temperature Controller from the case, turn the power supply OFF first, and absolutely do not touch the terminals or electronic components or apply shock to them. When inserting the Temperature Controller, do not allow the electronic components to come into contact with the case.
25. Static electricity may damage internal components. Always touch grounded metal to discharge any static electricity before handling the Temperature Controller. When drawing out the Temperature Controller from the case, do not touch the electronic components or patterns on the board with your hand. Hold the Temperature Controller by the edge of the front panel when handling it.
26. Do not use paint thinner or similar chemical to clean with. Use standard grade alcohol.
27. Use tools when separating parts for disposal. Contact with the sharp internal parts may cause injury.

## Precautions for Correct Use

### Service Life

1. Use the product within the following temperature and humidity ranges:  
Temperature:  $-10$  to  $55^{\circ}\text{C}$  (with no icing or condensation)  
Humidity: 25% to 85%  
If the product is installed inside a control board, the ambient temperature must be kept to under  $55^{\circ}\text{C}$ , including the temperature around the product.
2. The service life of electronic devices like Temperature Controllers is determined not only by the number of times the relay is switched but also by the service life of internal electronic components. Component service life is affected by the ambient temperature: the higher the temperature, the shorter the service life and, the lower the temperature, the longer the service life. Therefore, the service life can be extended by lowering the temperature of the Temperature Controller.
3. When two or more Temperature Controllers are mounted horizontally close to each other or vertically next to one another, the internal temperature will increase due to heat radiated by the Temperature Controllers and the service life will decrease. In such a case, use forced cooling by fans or other means of air ventilation to cool down the Temperature Controllers. When providing forced cooling, however, be careful not to cool down the terminals sections alone to avoid measurement errors.

### Measurement Accuracy

1. When extending or connecting the thermocouple lead wire, be sure to use compensating wires that match the thermocouple types.
2. When extending or connecting the lead wire of the platinum resistance thermometer, be sure to use wires that have low resistance and keep the resistance of the three lead wires the same.
3. Mount the product so that it is horizontally level.
4. If the measurement accuracy is low, check to see if input shift has been set correctly.

### Operating Precautions

1. It takes approximately two seconds for the outputs to turn ON from after the power supply is turned ON. Due consideration must be given to this time when incorporating Temperature Controllers in a sequence circuit.
2. When using self-tuning, turn ON power for the load (e.g., heater) at the same time as or before supplying power to the Temperature Controller. If power is turned ON for the Temperature Controller before turning ON power for the load, self-tuning will not be performed properly and optimum control will not be achieved.
3. When starting operation after the Temperature Controller has warmed up, turn OFF the power and then turn it ON again at the same time as turning ON power for the load. (Instead of turning the Temperature Controller OFF and ON again, switching from STOP mode to RUN mode can also be used.)
4. Avoid using the Controller in places near a radio, television set, or wireless installing. These devices can cause radio disturbances which adversely affect the performance of the Controller.

### Mounting (E5EZ-PRR)

1. Insert the E5EZ-PRR into the mounting hole in the panel from the front.
2. Push the mounting bracket along the E5EZ-PRR body from the terminals up to the panel, and secure it temporarily.
3. Tighten the fixing screw on each mounting bracket alternately until the ratchet stops tightening.

#### E5EZ-PRR

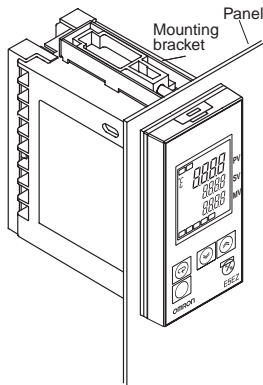

### Removing the Temperature Controller from the Case

To remove the Temperature Controller from case, use a suitable Phillips screwdriver for the screw located at the bottom on the front panel.

1. Insert the tools (see drawing above) into the slots (one on the top and one on the bottom) and release the hooks.
2. Insert the tool in the space between the front and rear panels and slightly pull out the front panel. Hold the top and bottom of the front panel and pull toward yourself to remove it.
3. Match up the upper and lower claws with the connection points and insert the Option Unit. Mount the Option Unit in the center.
4. Insert the Unit into the rear case until you hear a click. When inserting the Unit, press down the hooks on the top and bottom of the rear case so that they firmly hook on the inserted Unit. Make sure that electronic parts do not come in contact with the case.

#### E5EZ-PRR

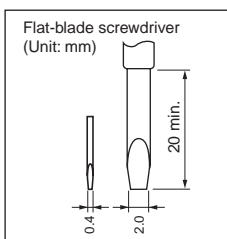
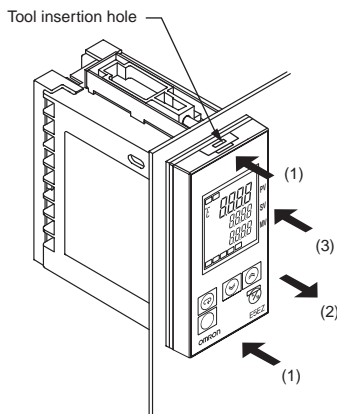

### Precautions when Wiring

- Separate input leads and power lines in order to prevent external noise.
- Use wires with a gage of AWG24 (cross-sectional area: 0.205 mm<sup>2</sup>) to AWG14 (cross-sectional area: 2.081 mm<sup>2</sup>) twisted-pair cable (stripping length: 5 to 6 mm).
- Use crimp terminals when wiring the terminals.
- Tighten the terminal screws to a torque of 0.74 to 0.9 N-m.
- Use the following types of crimp terminals for M3.5 screws.

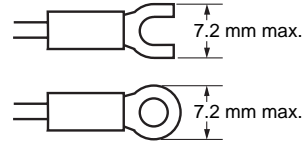

- Do not remove the terminal block. Doing so will result in malfunction or failure.





# Warranty and Application Considerations

## Read and Understand This Catalog

Please read and understand this catalog before purchasing the products. Please consult your OMRON representative if you have any questions or comments.

## Warranty and Limitations of Liability

### WARRANTY

OMRON's exclusive warranty is that the products are free from defects in materials and workmanship for a period of one year (or other period if specified) from date of sale by OMRON.

OMRON MAKES NO WARRANTY OR REPRESENTATION, EXPRESS OR IMPLIED, REGARDING NON-INFRINGEMENT, MERCHANTABILITY, OR FITNESS FOR PARTICULAR PURPOSE OF THE PRODUCTS. ANY BUYER OR USER ACKNOWLEDGES THAT THE BUYER OR USER ALONE HAS DETERMINED THAT THE PRODUCTS WILL SUITABLY MEET THE REQUIREMENTS OF THEIR INTENDED USE. OMRON DISCLAIMS ALL OTHER WARRANTIES, EXPRESS OR IMPLIED.

### LIMITATIONS OF LIABILITY

OMRON SHALL NOT BE RESPONSIBLE FOR SPECIAL, INDIRECT, OR CONSEQUENTIAL DAMAGES, LOSS OF PROFITS, OR COMMERCIAL LOSS IN ANY WAY CONNECTED WITH THE PRODUCTS, WHETHER SUCH CLAIM IS BASED ON CONTRACT, WARRANTY, NEGLIGENCE, OR STRICT LIABILITY.

In no event shall the responsibility of OMRON for any act exceed the individual price of the product on which liability is asserted.

IN NO EVENT SHALL OMRON BE RESPONSIBLE FOR WARRANTY, REPAIR, OR OTHER CLAIMS REGARDING THE PRODUCTS UNLESS OMRON'S ANALYSIS CONFIRMS THAT THE PRODUCTS WERE PROPERLY HANDLED, STORED, INSTALLED, AND MAINTAINED AND NOT SUBJECT TO CONTAMINATION, ABUSE, MISUSE, OR INAPPROPRIATE MODIFICATION OR REPAIR.

## Application Considerations

### SUITABILITY FOR USE

OMRON shall not be responsible for conformity with any standards, codes, or regulations that apply to the combination of products in the customer's application or use of the products.

Take all necessary steps to determine the suitability of the product for the systems, machines, and equipment with which it will be used.

Know and observe all prohibitions of use applicable to this product.

NEVER USE THE PRODUCTS FOR AN APPLICATION INVOLVING SERIOUS RISK TO LIFE OR PROPERTY WITHOUT ENSURING THAT THE SYSTEM AS A WHOLE HAS BEEN DESIGNED TO ADDRESS THE RISKS, AND THAT THE OMRON PRODUCTS ARE PROPERLY RATED AND INSTALLED FOR THE INTENDED USE WITHIN THE OVERALL EQUIPMENT OR SYSTEM.

## Disclaimers

### PERFORMANCE DATA

Performance data given in this catalog is provided as a guide for the user in determining suitability and does not constitute a warranty. It may represent the result of OMRON's test conditions, and the users must correlate it to actual application requirements. Actual performance is subject to the OMRON *Warranty and Limitations of Liability*.

### CHANGE IN SPECIFICATIONS

Product specifications and accessories may be changed at any time based on improvements and other reasons. Consult with your OMRON representative at any time to confirm actual specifications of purchased product.

### DIMENSIONS AND WEIGHTS

Dimensions and weights are nominal and are not to be used for manufacturing purposes, even when tolerances are shown.

#### OMRON Corporation

Industrial Automation Company  
Control Devices Division H.Q.  
Industrial Component Division  
2-2-1 Nishikusatsu, Kusatsu-shi,  
Shiga, 525-0035 Japan  
Tel: (81) 77-565-5160/Fax: (81) 77-565-5569

#### Regional Headquarters

OMRON EUROPE B.V.  
Wegalaan 67-69-2132 JD Hoofddorp  
The Netherlands  
Tel: (31)2356-81-300/Fax: (31)2356-81-388  
OMRON Industrial Automation Global: [www.ia.omron.com](http://www.ia.omron.com)

#### OMRON ELECTRONICS LLC

One Commerce Drive Schaumburg,  
IL 60173-5302 U.S.A.  
Tel: (1) 847-843-7900/Fax: (1) 847-843-7787

#### OMRON ASIA PACIFIC PTE. LTD.

No. 438A Alexandra Road # 05-05/08 (Lobby 2),  
Alexandra Technopark, Singapore 119967  
Tel: (65) 6835-3011/Fax: (65) 6835-2711

#### OMRON (CHINA) CO., LTD.

Room 2211, Bank of China Tower,  
200 Yin Cheng Zhong Road,  
PuDong New Area, Shanghai, 200120, China  
Tel: (86) 21-5037-2222/Fax: (86) 21-5037-2200

#### Authorized Distributor:

© OMRON Corporation 2009 All Rights Reserved.  
In the interest of product improvement,  
specifications are subject to change without notice.

Cat. No. H209-E1-03

Printed in Japan  
0909