

DESCRIPTION: FEMALE - HIGH DENSITY - MACHINED CONTACTS - VERTICAL

MATERIALS AND FINISH:

SHELL: STEEL MATERIAL, NICKEL FINISH
 INSULATOR: PA6T = 260°C, UL 94V-0 RATED, BLACK
 CONTACT MATERIAL: BRASS
 CONTACT FINISH: FULL GOLD FLASH
 SEAL MATERIAL: F04 FLEXIBLE ADHESIVE

ELECTRICAL:

CONTACT CURRENT RATING: 5 AMPS
 CONTACT RESISTANCE: 30 Milliohms Max.
 DIELECTRIC WITHSTANDING VOLTAGE: 1,000VAC Min.
 INSULATION RESISTANCE: 5,000 Megohms Min.
 TEMPERATURE RATING: -55° ~ +105° C

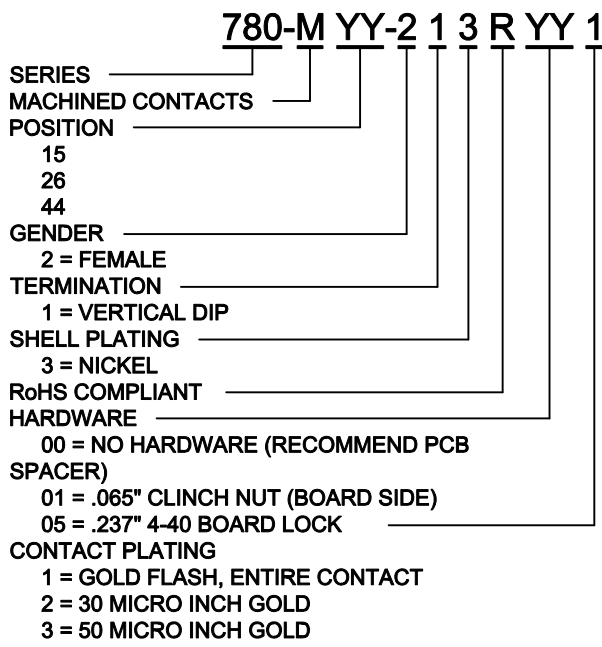
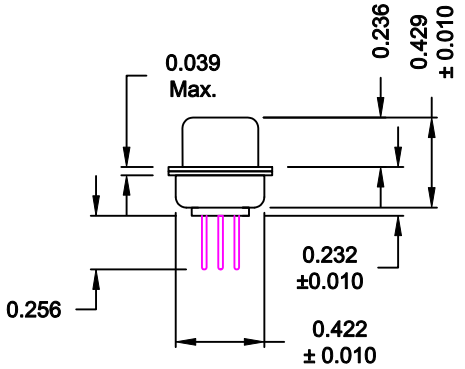
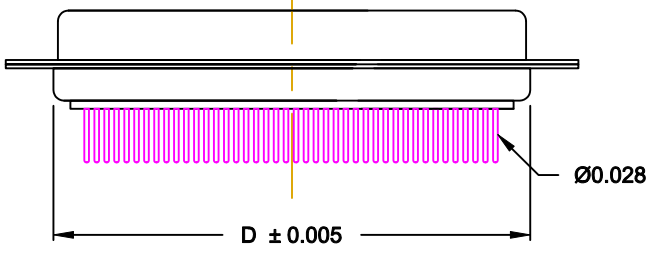
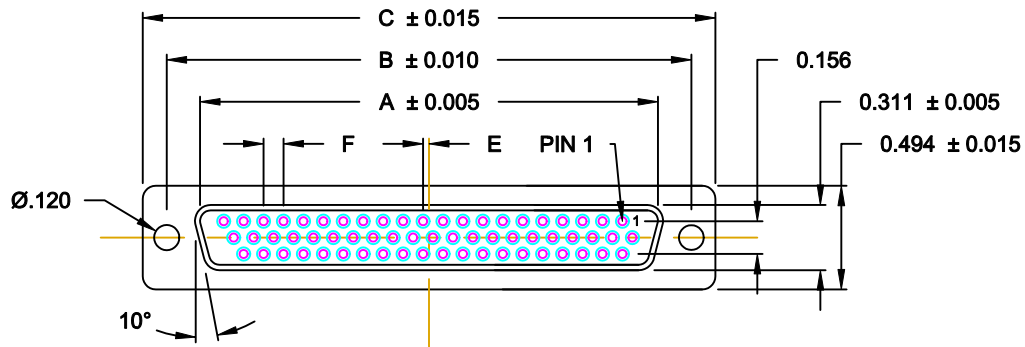

MEETS IP67 STANDARDS

DO NOT SCALE FROM DRAWING

DIMENSIONS (IN.)						
No. OF PINS	A	B	C	D	E	F
15	0.643	0.984	1.213	0.759	0.010	0.090
26	0.971	1.312	1.541	1.083	0.020	0.090
44	1.511	1.852	2.088	1.625	0.020	0.090

	THESE DRAWINGS AND SPECIFICATIONS ARE THE PROPERTY OF NorComp AND SHALL NOT BE REPRODUCED, COPIED OR USED AS THE BASIS FOR THE MANUFACTURE OF SALE OF APPARATUS WITHOUT WRITTEN PERMISSION.		DRAWN: P. JENKINS	DATE: 03-16-07
			CHECKED:	DATE:
<h1>NorComp</h1>		SCALE: 1 : 1	SHEET 1	OF 4
		DWG NO. 780-MYY-213RYY1		

RoHS COMPLIANT

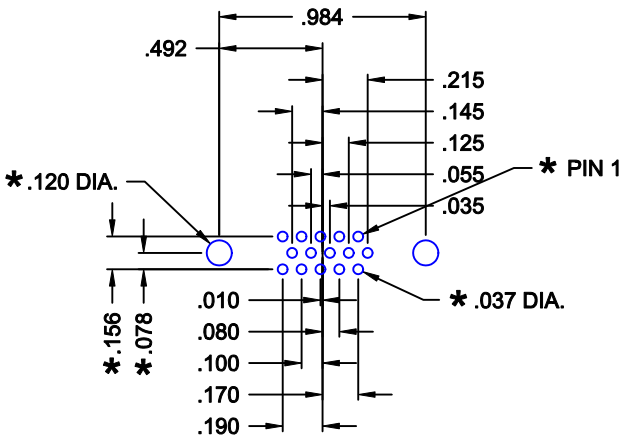

15 POSITION

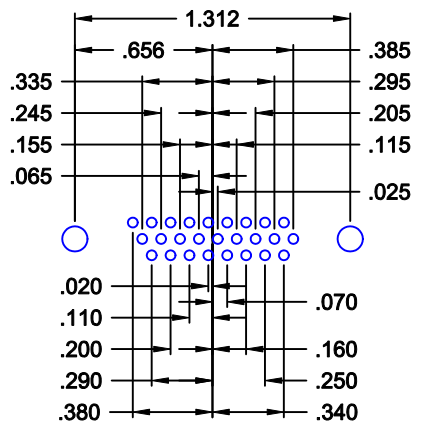

26 POSITION

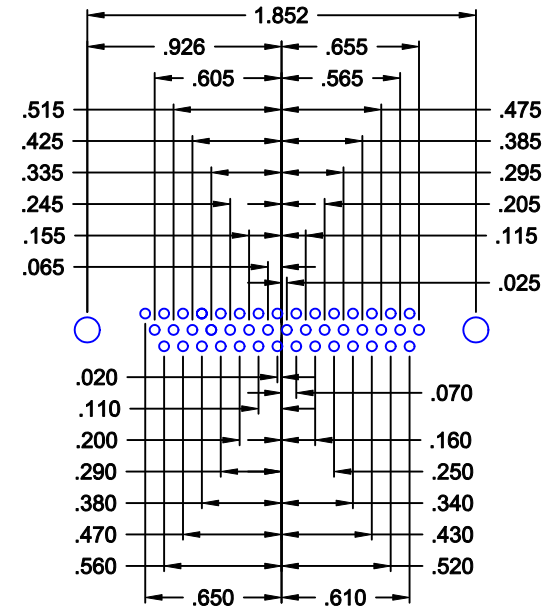

44 POSITION

* TYP. ON ALL SIZES

DO NOT SCALE FROM DRAWING

RoHS COMPLIANT

	THESE DRAWINGS AND SPECIFICATIONS ARE THE PROPERTY OF NorComp AND SHALL NOT BE REPRODUCED, COPIED OR USED AS THE BASIS FOR THE MANUFACTURE OF SALE OF APPARATUS WITHOUT WRITTEN PERMISSION.		DRAWN: P. JENKINS	DATE: 06-24-09
			CHECKED:	DATE:
NorComp		SCALE: 1 : 1	SHEET 2 OF 4	REV 6
		DWG NO. 780-MYY-213RYY1		

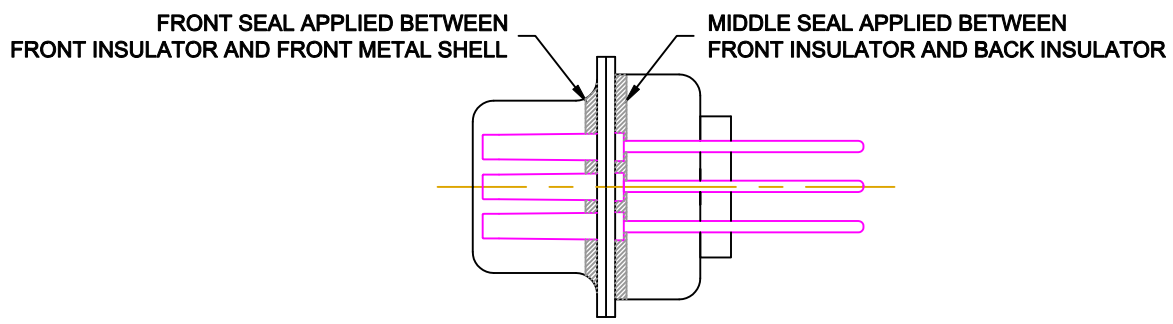
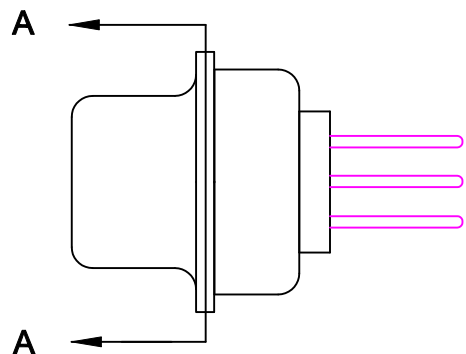

DETAIL A-A

DO NOT SCALE FROM DRAWING

	THESE DRAWINGS AND SPECIFICATIONS ARE THE PROPERTY OF NorComp AND SHALL NOT BE REPRODUCED, COPIED OR USED AS THE BASIS FOR THE MANUFACTURE OR SALE OF APPARATUS WITHOUT WRITTEN PERMISSION.		DRAWN: C. SMITH	DATE: 03-26-09	
			CHECKED:	DATE:	
<h1>NorComp</h1>			SCALE: 2.5 : 1	SHEET 3 OF 4	REV 6
			DWG NO. 780-MYY-213RYY1		

RoHS COMPLIANT

HARDWARE OPTIONS

01X 0.065" (BOARD SIDE) - CN1

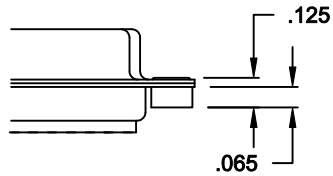

05X 0.237" (BOARD SIDE) - CN10

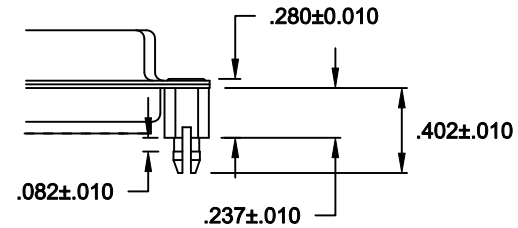

DO NOT SCALE FROM DRAWING



THESE DRAWINGS AND SPECIFICATIONS ARE THE PROPERTY OF NorComp AND SHALL NOT BE REPRODUCED, COPIED OR USED AS THE BASIS FOR THE MANUFACTURE OR SALE OF APPARATUS WITHOUT WRITTEN PERMISSION.

DRAWN: M. SIGMON		DATE: 01-21-11	
CHECKED:		DATE:	
SCALE: N.T.S.	SHEET 4	OF 4	REV 6
DWG NO. 780-MYY-213RYY1			

RoHS COMPLIANT

NorComp