

SMD Power Inductor CDC4D20



Description

- Ferrite drum core construction.
- Magnetically unshielded.
- L × W × H: 5.0 × 5.0 × 2.0 mm Max.
- Product weight: 106mg(Ref.)
- Moisture Sensitivity Level: 1
- RoHS compliance.

Environmental Data

- Operating temperature range: -40°C ~ +85°C (including coil's self temperature rise)
- Storage temperature range: -40°C ~ +85°C
- Solder reflow temperature: 260 °C peak.

Packaging

- Carrier tape and reel packaging
- 7.0" diameter reel
- 1000pcs per reel

Applications

- Ideally used in EL drive as EL lamp inverter inductors.

Dimension - [mm]

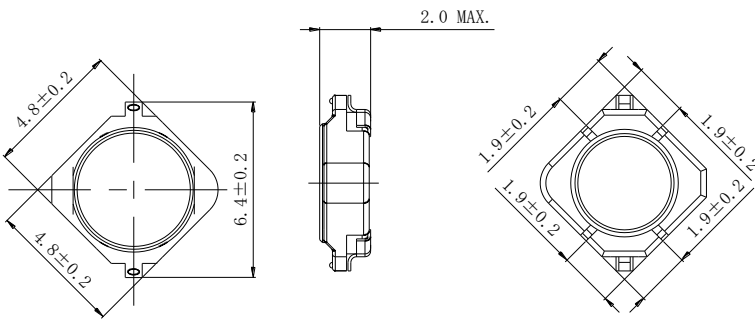

Land pattern and Schematics - [mm]

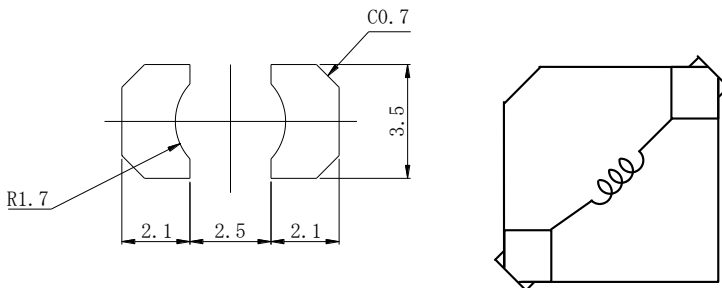



Electrical Characteristics

Part Name	Stamp	Inductance [Within] ※1	D.C.R.(Ω) Max. (Typ.) (at 20°C)	Saturation Current (mA) ※2	Temperature Rise Current (mA) ※3
CDC4D20NP-101KC	A	100μH±10%	1.77 (1.48)	275	230
CDC4D20NP-121KC	B	120μH±10%	1.97(1.65)	250	220
CDC4D20NP-151KC	C	150μH±10%	2.61(2.18)	230	195
CDC4D20NP-181KC	D	180μH±10%	2.73(2.28)	210	190
CDC4D20NP-221KC	E	220μH±10%	3.20(2.67)	190	180
CDC4D20NP-271KC	F	270μH±10%	3.66(3.05)	170	160
CDC4D20NP-331KC	G	330μH±10%	5.16(4.30)	160	135
CDC4D20NP-391KC	H	390μH±10%	5.66(4.72)	140	130
CDC4D20NP-471KC	J	470μH±10%	7.30(6.08)	130	110
CDC4D20NP-561KC	K	560μH±10%	8.40(6.99)	120	105
CDC4D20NP-681KC	L	680μH±10%	9.60(8.00)	110	90
CDC4D20NP-821KC	M	820μH±10%	14.1(11.7)	100	75
CDC4D20NP-102KC	N	1.0mH±10%	16.2(13.5)	90	70
CDC4D20NP-122KC	P	1.2mH±10%	18.6(15.5)	80	65
CDC4D20NP-152KC	Q	1.5mH±10%	23.8(19.8)	75	55
CDC4D20NP-182KC	R	1.8mH±10%	27.1(22.6)	65	55
CDC4D20NP-222KC	S	2.2mH±10%	31.6(26.3)	60	50
CDC4D20NP-272KC	T	2.7mH±10%	38.9(32.4)	55	45
CDC4D20NP-332KC	U	3.3mH±10%	43.7(36.4)	50	40
CDC4D20NP-392KC	V	3.9mH±10%	50.9(42.4)	45	38
CDC4D20NP-472KC	W	4.7mH±10%	72.1(60.0)	40	34

※1. Inductance measuring condition: at 1 kHz.

※2. Saturation current: The value of D.C. current when the inductance decreases to 90% of it's nominal value.

※3. Temperature rise current: The value of D.C. current when the temperature rise is $\Delta t=40^{\circ}\text{C}$ ($T_a=20^{\circ}\text{C}$).

SMD Power Inductor CDC4D20



Saturation Current & Temperature Rise Graph

— L (20°C) — ΔT

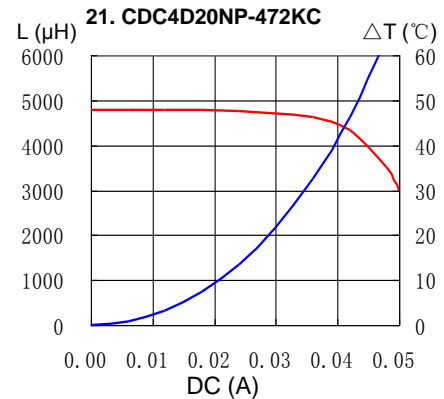
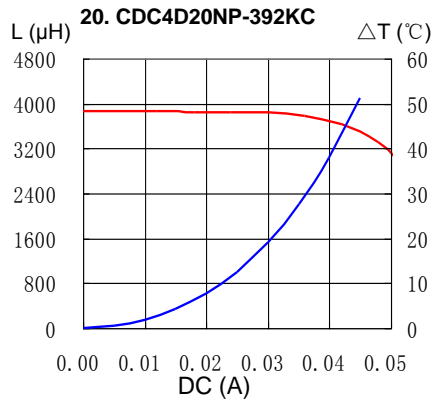
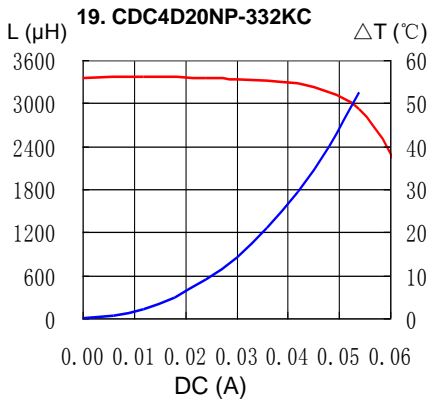
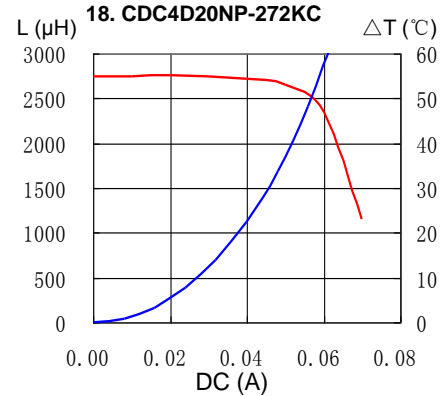
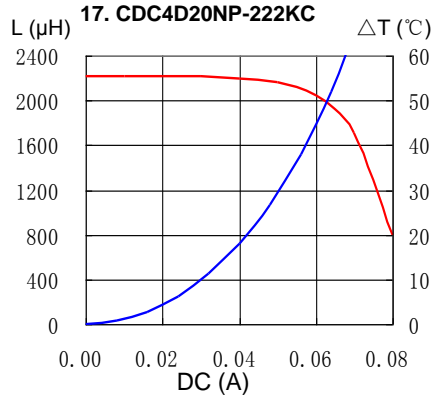
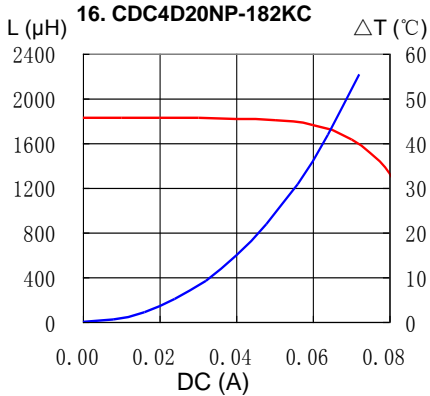
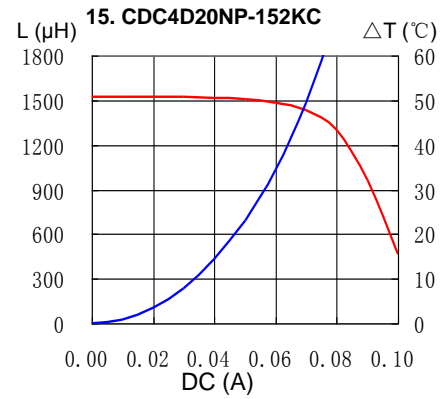
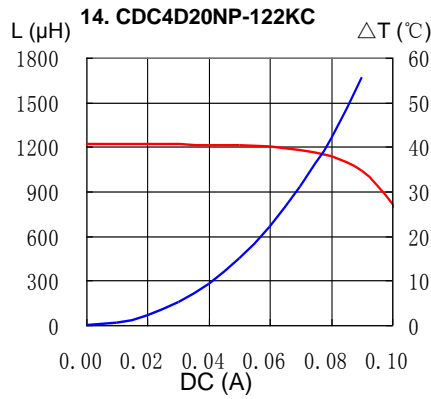
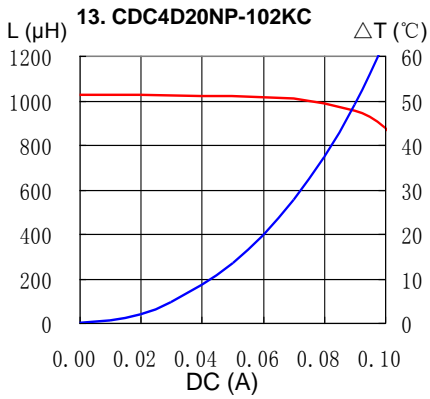

SMD Power Inductor CDC4D20



Solder Reflow Condition

Heat Endurance

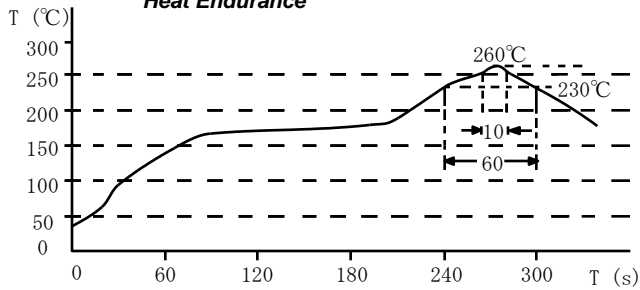

Temperature Chart

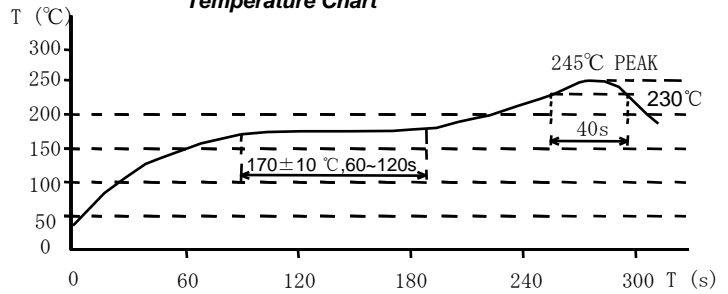

Please refer to the sales offices on our website - <http://www.sumida.com>

Hong Kong

Tel.+852-2880-6781
FAX.+852-2565-9600
sales@hk.sumida.com

Saitama(Japan)

Tel.+81-48-691-7300
FAX.+81-48-691-7340
sales@jp.sumida.com

Chicago

Tel.+1-847-545-6700
FAX. +1-847-545-6720
sales@us.sumida.com

Shanghai

Tel.+86-21-5836-3299
FAX.+86-21-5836-3266
shanghai.sales@cn.sumida.com

Seoul

Tel.+82-2-6237-0777
FAX.+82-2-6237-0778
sales@kr.sumida.com

Obernzell

Tel.+49-8591-937-0
FAX. +49-8591-937-103
contact@eu.sumida.com

Shenzhen

Tel.+86-755-8291-0228
FAX.+86-755-8291-0338
shenzhen.sales@cn.sumida.com

Singapore

Tel.+65-6296-3388
FAX.+65-6841-4426
sales@sg.sumida.com

Neumarkt

Tel.+49-9181-4509-110
FAX. +49-9181-4509-310
infocomp@eu.sumida.com

Taipei

Tel.+886-2-8751-2737
FAX.+886-2-8751-2738
sales@tw.sumida.com

San Jose

Tel.+1-408-321-9660
FAX.+1-408-321-9308
sales@us.sumida.com