



NEVALO SSL System

CN58 LED Light Module (LLM)

4 LED, 350mA, 3000 CCT

Features

- › Inter-changeable light modules and optics
- › 340 lumens in 3000K color temperature
- › 18, 25 and 45 degree optics
- › Mechanically keyed and color coded interconnect for easy installation
- › Protection with NEVALO driver
 - » Thermal shutdown
 - » Short circuit
 - » Input surge voltage
 - » Over voltage
 - » Over current
- › Lifetime: 50,000 hours minimum
- › Integrated thermal pad
- › Dry and damp location compatible
- › Accepts future and improved LEDs and optics
- › 5 year warranty with NEVALO system

The NEVALO CN58 LED Light Module (LLM) offers plug-and-play versatility for flexibility, performance, and speed to market in a multi-lumen, energy efficient package. It is uniquely designed to allow inter-changeability by the lighting OEM designer to select between multiple lumen outputs, color temperatures, CRIs and beam distributions in the same package. Designed with thermal and electrical protection and when used with the NEVALO SSL System the CN58 LLM comes with a 5 year warranty.

APPLICATIONS

- › Residential and Light Commercial
- › Downlights
- › Track and Spots

MECHANICAL CONSTRUCTION

Base Housing: Glass Filled PBT - White

Thermal Pad: Silicone

LED Board: Aluminum clad PCB

Washer: Steel, Zinc Plated

Screws: Steel, Zinc Plated

Optic TIR: Optical grade acrylic

Top Ring: Glass Filled PBT - White

Compression Ring: Urethane

ELECTRICAL CHARACTERISTICS

Component	Material
Maximum Forward Voltage	14 Volts
Maximum Forward Current	350 mA

ENVIRONMENTAL

Storage Temperature: -40°C to 85°C

Operating Temperature: -20°C to 85°C

Humidity: 5-85% non-condensing

ROHS Compliant: Yes

ORDERING INFORMATION

CCT (1) (K)	LLM Lumen (lm) Typ/ includes Optics Tc=60° C	LLM Lumen (lm) Typ/ includes Optics Tc=25° C	CRI	Color Consistency SDCM	Drive Current	LLM Efficacy (2) (lm/W) Typ/ includes Optics Tc=25° C	NEVALO (3) System Budget	Beam Distribution Angle (degrees)	Part Number
3000	320	340	80	4	350mA	84	14	Spot 18°	2154196-1
3000	320	340	80	4	350mA	84	14	Narrow Flood 25°	2154196-2
3000	320	340	80	4	350mA	84	14	Flood 45°	2154196-3

(1) CCT Tolerance: 3045K ± 100K

(2) Individual results may vary from the typical values.

(3) System Budget is a unique NEVALO SSL system feature that allows the appropriate LED Light Module (LLM) loading to the driver. Orange = 350mA and matches color coding on driver.

nevalo.com
te.com

© 2011 Tyco Electronics Corporation. All Rights Reserved.

9-1773459-0 CIS PDF 03/2011

NEVALO, TE (logo) and TE Connectivity are trademarks of the TE Connectivity group of companies and its licensors.

Other products, logos, and company names mentioned herein may be trademarks of their respective owners.



NEVALO SSL System

CN58 LED Light Module (LLM)

4 LED, 350mA, 3000 CCT

APPROVALS

Parameter	Standard
USA Safety	UL 8750 Recognized (pending)
International Safety	CE mark to IEC 62031:2008 (pending)

DOCUMENTS

Click for link to document	
Product Specification	108-2451
Application Specification	114-13293
Instruction Sheet	408-10422
Customer Drawing	2154196-1 2154196-2 2154196-3 2154172-1 2154175-1

WIRING BUS

Configuration	Length	Part Number
Straight to Straight	300mm	2154172-1
Straight to Right Angle Down	300mm	2154175-1

Use a factory assembled wiring bus to connect driver to LLM or build your own at the [online configurator](#)



PRODUCT DIMENSIONS

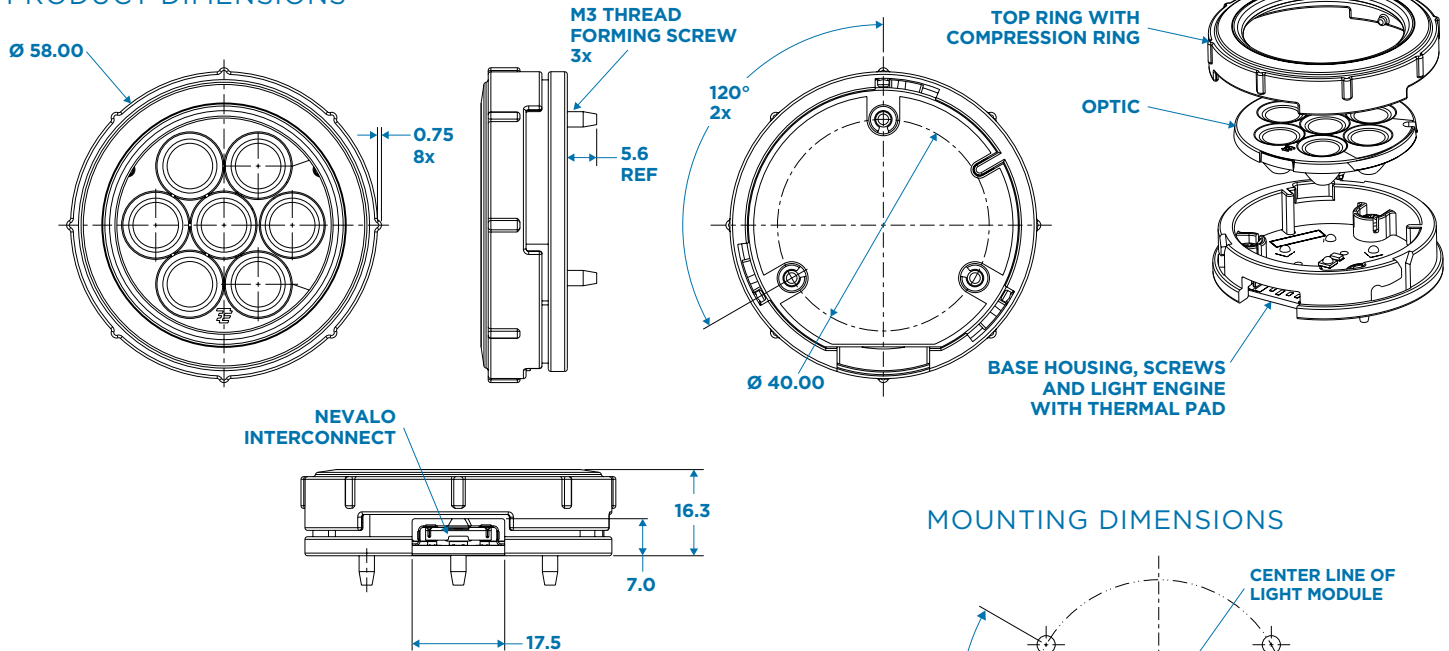

MOUNTING DIMENSIONS

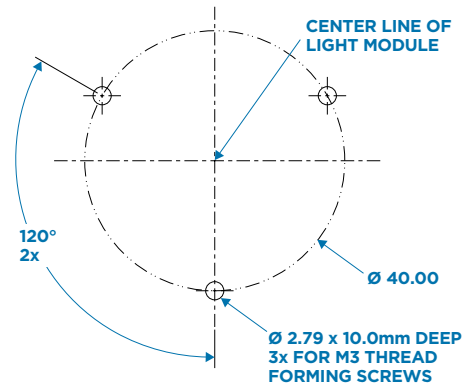

DRILL TEMPLATE KIT

Allows you to easily locate drill hole positions to attach LED light modules (LLM) to the light fixture.



[nevalo.com](#)
[te.com](#)

NEVALO SSL System

CN58 LED Light Module (LLM)

4 LED, 350mA, 3000 CCT

PHOTOMETRICS: 3000K CCT

Spot 18°

Imperial Units

Metric Units

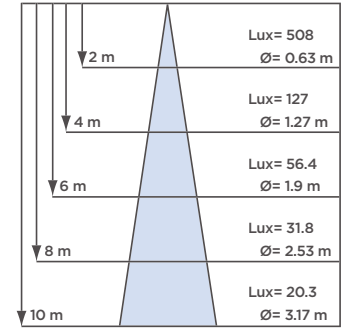
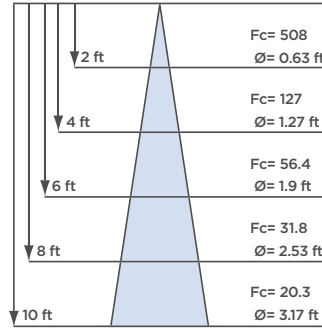
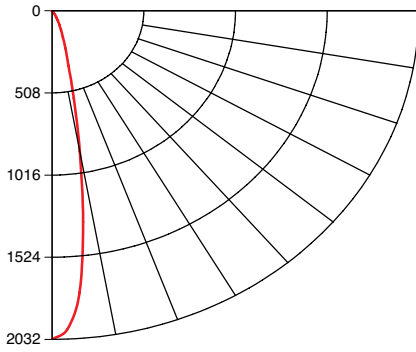

Narrow Flood 25°

Imperial Units

Metric Units

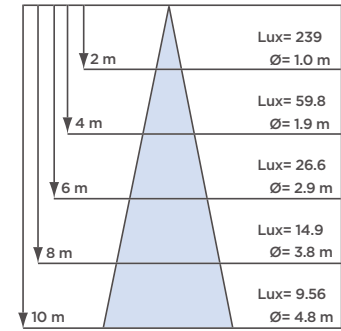
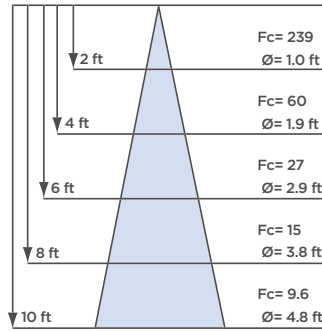
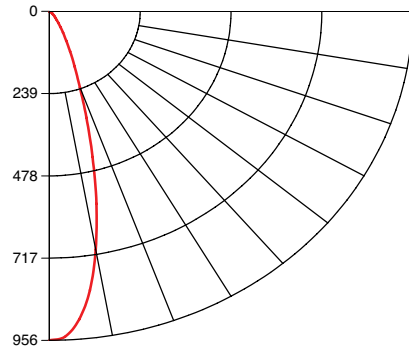

Flood 45°

Imperial Units

Metric Units

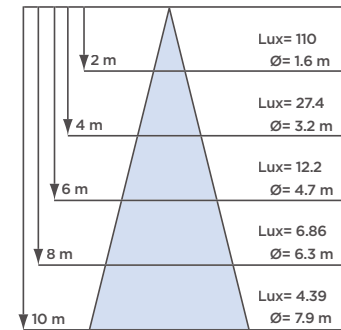
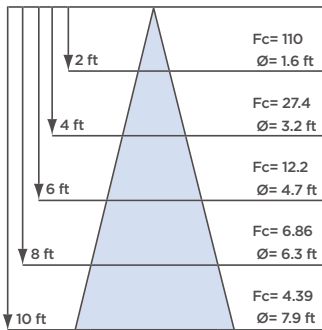
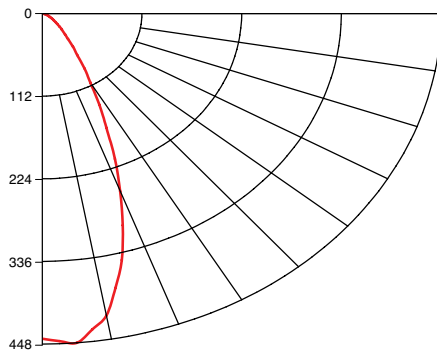

nevalo.com
te.com

© 2011 Tyco Electronics Corporation. All Rights Reserved.
9-1773459-0 CIS PDF 03/2011
NEVALO, TE (logo) and TE Connectivity are trademarks of the TE Connectivity group of companies and its licensors.
Other products, logos, and company names mentioned herein may be trademarks of their respective owners.



NEVALO SSL System

CN58 LED Light Module (LLM)

4 LED, 350mA, 3000 CCT

THERMAL LLM

Each LLM has a corresponding Thermal LLM which when placed in a lighting application can be connected to the NEVALO Thermal Test instrument. This unique accessory allows for an immediate thermal profile of the final product.





Thermal LLM board shown

LLM Part Number	Thermal LLM Part Number	Thermal Test Instrument Part Number
2154196-1	2154210-1	2154265-1
2154196-2		
2154196-3		

THERMAL TEST INSTRUMENT

A complementary test instrument is used to confirm the thermal protection and performance of every LLM in your fixture. The evaluation tool includes Break Out Box, Thermal Monitor Testing Software, and Interconnect Cables.



NEVALO SSL Thermal Ratings	LLM Tcase		
LED Driver Shutdown	85 - 105°C		
Thermal Tool : Red	> 85°C		
Thermal Tool : Yellow	75 - 85°C		
Thermal Tool : Green	< 75°C		
Thermal Dot	88°C		

nevalo.com
te.com