

## Ultra-High Precision Hermetically Sealed Bulk Metal<sup>®</sup> Foil Resistor with Zero TCR, no Humidity Effect and 0.005 % Tolerance within a Unique Construction, Minimizing the Effects of Stress Factors



### INTRODUCTION

The new VHP100 type represents a metrology breakthrough. A new construction concept combined with special treatments make this resistor the first choice in the most demanding instrumentation and laboratory applications.

The ability of the new VHP100 to minimize the changes in resistance value when the resistor is subjected to load variations and thermal stresses, ensure the ultra high performances for the tight metrology specifications.

The total error budget of 2 ppm drift and the high speed recovery represent an improvement of almost an order of magnitude on the earlier model.

Vishay has achieved an essentially Zero Temperature Coefficient Resistor in the VHP100 type. This oil filled hermetically sealed device makes unique use of foil on ceramic in such a way that self cancelling responses to temperature are produced by combining equal and opposite effects. This product is sold only in hermetic packages because applications requiring this level of temperature stability require humidity stability as well.

The value of the hermetic enclosure over the molded part is in the long term performance. The hermetic sealing prevents the ingress of moisture and oxygen, while the oil acts as a thermal conductor.

### TCR WINDOW DEFINITION

The TCR of the VHP100 is so small that an additional definition - **window**, has been introduced. The window definition requires that the absolute resistance remain within the stated window over the temperature range specified. The resistance of the VHP100 resistor stays within a 60 ppm window over the entire military temperature range of - 55 °C to + 125 °C (figures 1 and 3).

A window of 10 ppm is available for the laboratory instrument range (+ 15 °C to + 45 °C); see figure 4 - type VHP101.

### TCR TRACKING

Tracking of the VHP100 resistor is also vastly superior to conventional precision resistors. Typical  $\pm 5$  ppm/°C precision resistors have a worst-case tracking of 10 ppm/°C (wirewounds, thick film, thin film) or a difference between resistors of 1000 ppm (10 ppm/°C x 100 °C) when temperature changes from + 25 °C to + 125 °C. For a 3 ppm/°C tracking (Vishay S102C) the difference will be 300 ppm (3 ppm/°C x 100 °C) for the same temperature range. The VHP100 resistors will track to 60 ppm from - 55 °C to + 125 °C, a five-fold improvement over the S102C resistor.

### FEATURES

- Essentially zero TCR
- Absolute resistance change (**window**):  
VHP100 < 60 ppm (- 55 °C to + 125 °C)  
VHP101 < 10 ppm (+ 15 °C to + 45 °C)
- Tolerance: to  $\pm 0.005$  % (50 ppm) - (available to  $\pm 0.001$  % (10 ppm))
- No humidity effect: hermetically sealed against moisture
- Load life stability:  $\pm 50$  ppm typical for 2000 h, 70 °C at 0.3 W
- Shelf life stability:  $\pm 2$  ppm typical after at least 6 years
- Resistance range: 100  $\Omega$  to 150 k $\Omega$  (higher or lower values available on request)
- Vishay Foil resistors are not restricted to standard values; specific "as required" values can be supplied at no extra cost or delivery (e.g. 1K2345 vs. 1K)
- Electrostatic discharge (ESD) up to 25 000 V
- Non inductive, non capacitive design
- Rise time: 1 ns effectively no ringing
- Thermal stabilization < 1 s
- Current noise: 0.010  $\mu\text{V}_{\text{RMS}}/\text{V}$  of applied voltage (< - 40 dB)
- Thermal EMF: 0.05  $\mu\text{V}/^\circ\text{C}$  typical
- Voltage coefficient: < 0.1 ppm/V
- Inductance: < 0.08  $\mu\text{H}$
- Non hot spot design
- Hermeticity:  $10^{-7}$  atmospheric cc/s max.
- Terminal finish: lead (Pb)-free, tin/lead alloy
- Compliant to RoHS directive 2002/95/EC
- Oil filled as standard, **air filled available upon request**
- Load-life stability can be considerably improved through in-house oriented tests



Available  
**RoHS\***  
COMPLIANT

### POST MANUFACTURING OPERATIONS ENHANCE THE ALREADY GREATER STABILITY OF FOIL RESISTORS

These PMO operations are uniquely applicable to resistors made of resistive foil and they take the already superior stability of foil devices one step further. The PMO operations described are not applicable to thick film, thin film, or wire. They constitute an exercising of the resin that bonds the foil to the substrate.

The exercises that are employed are (1) temperature cycling (2) short time overload, and (3) accelerated load life.

### TEMPERATURE CYCLING

This exercise is done initially in the chip stage of all production and will eliminate any fallout in the PMO cycling. The cycling exercises the bonding resin and relaxes the foil without reducing the bonding strength. A small reduction in resistance is tolerable during this PMO operation.

\* Pb containing terminations are not RoHS compliant, exemptions may apply

### SHORT TIME OVERLOAD

The STO operation is performed on all resistors during manufacturing. Its function is to eliminate sports (if any) so this PMO operation is further assurance.

### ACCELERATED LOAD

The standard load-life curve of a foil resistor exhibits a change in the beginning and not much change after the first 100 h. This knee in the load-life curve can be removed so that the resistor is now always on the flat part of the curve by employing the PMO exercise of accelerated loading. How much acceleration is a function of the application and should be worked out between our applications engineering department and your design team.

These same operations when applied to resistors of thick film, thin film, and wire have vastly different consequences and are applicable to foil only. They are an enhancement to foil performance but can drive other devices out of tolerance or open. The failure mechanisms in these other devices are too numerous to discuss here but suffice it to say, foil is the least affected by these PMO operations and they should be considered when the level of stability required is beyond the published limits for standard product.

**FIGURE 1 - A TYPICAL VHP100 RESISTANCE TEMPERATURE CURVE**

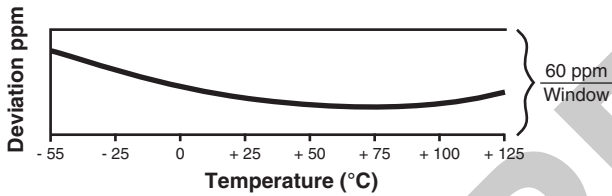

**FIGURE 2 - POWER DERATING CURVE**

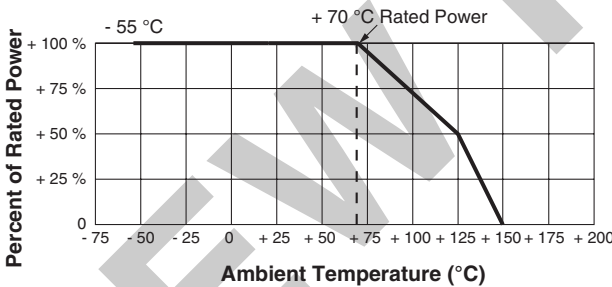

**FIGURE 3 - TYPICAL CURVES WITHIN THE 60 ppm WINDOW, VHP100 TCR FOR MIL RANGE**

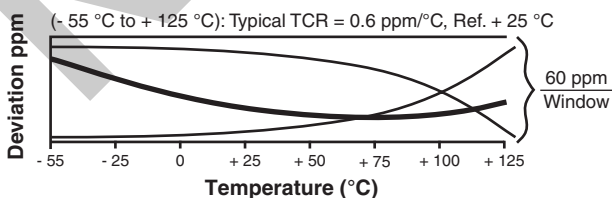

**FIGURE 4 - TYPICAL CURVES WITHIN 10 ppm WINDOW, VHP101 LABORATORY INSTRUMENT RANGE**

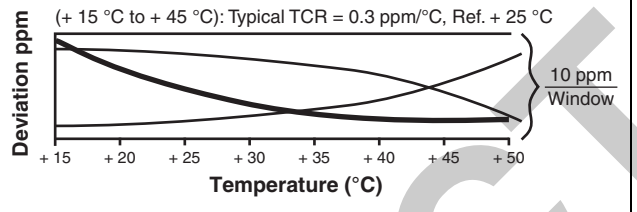

**FIGURE 5 - STANDARD PRINTING**

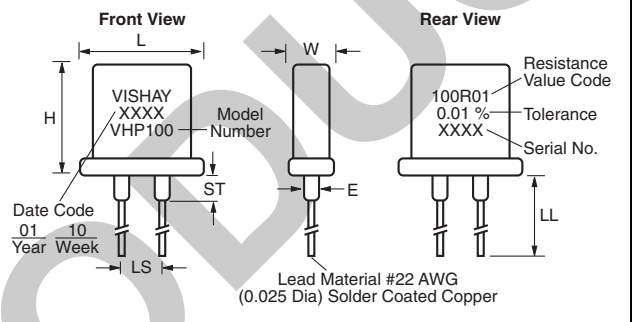

TOLERANCE	RESISTANCE SPECIFIED IN SIGNIFICANT DIGITS
± 1.0 %	3
± 0.1 %	4
± 0.01 %	5
± 0.005 %	6

**Note**  
The number of significant digits of resistance accuracy to be printed on the resistor should be in accordance with the specified tolerance

**TABLE 1 - VHP100 SERIES DIMENSIONS**

		INCHES	mm
VHP100	W	0.162 ± 0.020	4.11 ± 0.51
	L	0.415 ± 0.020	10.54 ± 0.51
VHP101	H	0.430 ± 0.020	10.92 ± 0.51
	LL	1.000 ± 0.125	25.4 ± 3.18
	LS <sup>(1)</sup>	0.150 ± 0.010	3.81 ± 0.25
	ST	0.100 maximum	2.54 maximum
	E	0.070 maximum	1.78 maximum

**Note**  
<sup>(1)</sup> For 0.200 lead spacing, specify **VHP102 (60 ppm)** or **VHP103 (10 ppm)**.

**TABLE 2 - VHP100 SPECIFICATIONS**

<b>Resistance Range</b>	100 Ω to 150 kΩ
<b>Tolerance at + 25 °C</b>	± 0.005 % to ± 1.0 %
<b>Power</b>	0.3 W at + 70 °C (see figure 2)
<b>Load Life Stability (1)</b> (for 2000 h)	0.3 W at + 70 °C; ± 0.015 % (150 ppm) maximum ΔR 0.15 W at + 125 °C; ± 0.015 % (150 ppm) maximum ΔR
<b>Shelf-Life Stability</b>	± 0.0002 % (2 ppm) after 6 years
<b>Thermal EMF</b> Due to temperature difference between leads Due to self-heating at 0.1 W	0.05 μV/°C 0 to 1 μV
<b>High Frequency Operation</b> Rise/decay time Inductance (L) Capacitance (C)	1.0 ns for 1 kΩ without ringing 0.1 μH maximum, 0.08 μH typical 1.0 pF maximum, 0.5 pF typical
<b>Maximum Working Voltage</b>	300 V
<b>Voltage Coefficient</b>	< 0.1 ppm/V
<b>Current Noise</b>	< 0.010 μV (RMS)/V (- 40 dB)
<b>Hermeticity</b>	10 <sup>-7</sup> atmospheric cc/s maximum

**Note**

(1) Load/life stability is considerably improved by reducing the temperature, power, or through in-house oriented tests.

**TABLE 3 - GLOBAL PART NUMBER INFORMATION (2)**

**NEW GLOBAL PART NUMBER: Y007880K2500A9L (preferred part number format)**

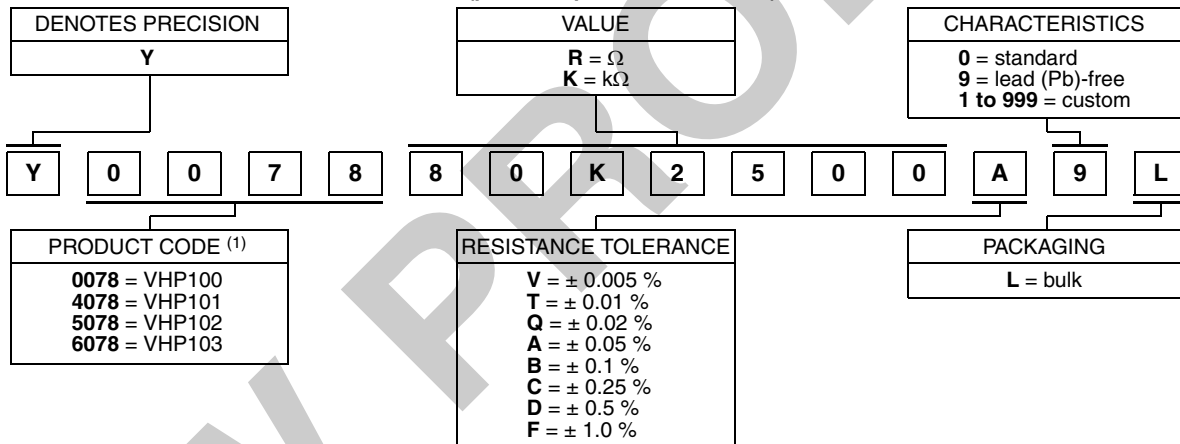

FOR EXAMPLE: ABOVE GLOBAL ORDER Y0078 80K2500 A 9 L:

TYPE: VHP100  
VALUE: 80.25 kΩ  
ABSOLUTE TOLERANCE: ± 0.05 %  
TERMINATION: lead (Pb)-free  
PACKAGING: bulk

**HISTORICAL PART NUMBER: VHP100T 80K250 A B (will continue to be used)**

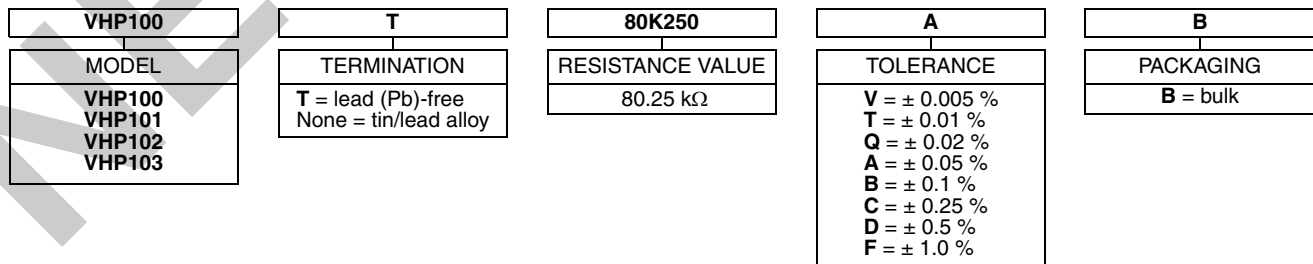

**Notes**

(1) For 0.200 lead spacing, specify **VHP102 (60 ppm)** or **VHP103 (10 ppm)**.

(2) For non-standard requests, please contact application engineering.



## Disclaimer

ALL PRODUCTS, PRODUCT SPECIFICATIONS AND DATA ARE SUBJECT TO CHANGE WITHOUT NOTICE.

Vishay Precision Group, Inc., its affiliates, agents, and employees, and all persons acting on its or their behalf (collectively, "VPG"), disclaim any and all liability for any errors, inaccuracies or incompleteness contained herein or in any other disclosure relating to any product.

The product specifications do not expand or otherwise modify VPG's terms and conditions of purchase, including but not limited to, the warranty expressed therein.

VPG makes no warranty, representation or guarantee other than as set forth in the terms and conditions of purchase. **To the maximum extent permitted by applicable law, VPG disclaims (i) any and all liability arising out of the application or use of any product, (ii) any and all liability, including without limitation special, consequential or incidental damages, and (iii) any and all implied warranties, including warranties of fitness for particular purpose, non-infringement and merchantability.**

Information provided in datasheets and/or specifications may vary from actual results in different applications and performance may vary over time. Statements regarding the suitability of products for certain types of applications are based on VPG's knowledge of typical requirements that are often placed on VPG products. It is the customer's responsibility to validate that a particular product with the properties described in the product specification is suitable for use in a particular application. You should ensure you have the current version of the relevant information by contacting VPG prior to performing installation or use of the product, such as on our website at [vpgsensors.com](http://vpgsensors.com).

No license, express, implied, or otherwise, to any intellectual property rights is granted by this document, or by any conduct of VPG.

The products shown herein are not designed for use in life-saving or life-sustaining applications unless otherwise expressly indicated. Customers using or selling VPG products not expressly indicated for use in such applications do so entirely at their own risk and agree to fully indemnify VPG for any damages arising or resulting from such use or sale. Please contact authorized VPG personnel to obtain written terms and conditions regarding products designed for such applications.

Product names and markings noted herein may be trademarks of their respective owners.

Copyright Vishay Precision Group, Inc., 2014. All rights reserved.