



UM10899

TEA1833DB1361 45 W demo board

Rev. 1 — 26 August 2015

User manual

Document information

Info	Content
Keywords	TEA1833DB1361, TEA1833TS, TEA1833LTS, notebook adapter
Abstract	This user manual provides the specification, schematics and PCB layout of the TEA1833DB1361 45 W (90 W peak) demo board. See the data sheet and application note for more information on the TEA1833TS/LTS IC.



Revision history

Rev	Date	Description
v.1	20150826	first issue

Contact information

For more information, please visit: <http://www.nxp.com>

For sales office addresses, please send an email to: salesaddresses@nxp.com

1. Introduction

WARNING

Lethal voltage and fire ignition hazard



The non-insulated high voltages that are present when operating this product, constitute a risk of electric shock, personal injury, death and/or ignition of fire.

This product is intended for evaluation purposes only. It shall be operated in a designated test area by personnel qualified according to local requirements and labor laws to work with non-insulated mains voltages and high-voltage circuits. This product shall never be operated unattended.

The TEA1833DB1361 demo board demonstrates the capabilities of the low-cost 6-pin TEA1833TS/LTS Switched-Mode Power Supply (SMPS) controller. This user manual describes the specification, the schematics, and the PCB layout of the TEA1833DB1361 45 W demo board. See the data sheet and application note for more information on the TEA1833TS/LTS IC.

Remark: Unless otherwise specified, all values are typical values.

1.1 Features

- Low no-load power (< 55 mW at 230 V (AC), output still in regulation)
- 200 % peak power
- Universal mains supply operation
- Low ripple and noise
- Small form factor
- Low-cost design
- Frequency reduction at low load to improve efficiency
- Efficiency DoE 2016 and COC 2014 compliant
- EMI CISPR22 compliant
- Brownin and brownout protection
- Output OverVoltage Protection (OVP)
- OverTemperature Protection (OTP)
- OverPower Protection with high/low compensation
- OverCurrent Protection (OCP)
- Output Short Circuit Protection (OSCP)

2. Safety warning

The TEA1833DB1361 demo board input is connected to the mains voltage. Avoid touching the board while it is connected to the mains voltage and when it is in operation. An isolated housing is obligatory when used in uncontrolled, non-laboratory environments. Galvanic isolation from the mains phase using a fixed or variable transformer is always recommended. [Figure 1](#) shows the symbols on how to recognize these devices.

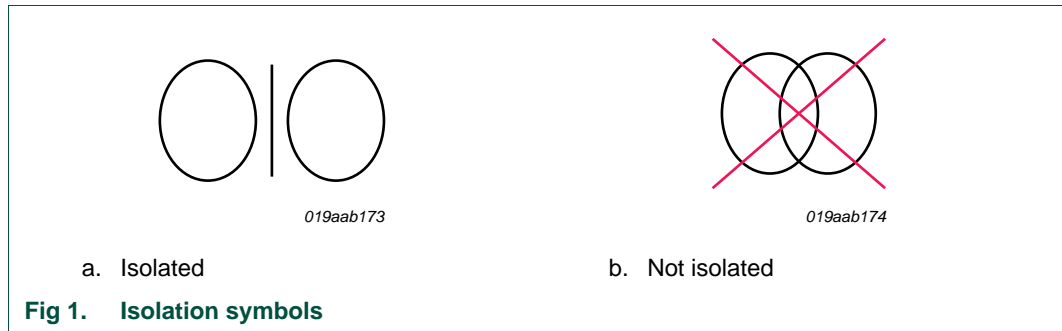

3. Power supply specification

[Table 1](#) lists the specification of the TEA1833DB1361 demo board.

Table 1. TEA1833DB1361 specifications

Symbol	Parameter	Value
V_i	input voltage	90 V to 264 V
f_i	input frequency	47 Hz to 64 Hz
P_i	input power	< 55 mW; no-load
V_o	output voltage	19.5 V
$V_{o(ripple)(p-p)}$	ripple output voltage	< 150 mV (p-p); full load; 20 MHz bandwidth; 10 μ F capacitor at end of cable
$P_{o(nom)}$	nominal output power	45 W
$P_{o(peak)}$	peak output power	> 90 W; 2 ms peak load during 50 % continuous load; 100 V (AC); 50 Hz; measured at end of cable
$V_{o(peak)}$	output voltage during peak load	> 18 V; 2 ms 200 % peak load during 50 % continuous load; 100 V (AC); 50 Hz; measured at end of cable
t_{holdup}	hold-up time	> 5 ms; 115 V (AC); 60 Hz; full load
$t_{startup}$	start-up time	< 2 s; 115 V (AC); 60 Hz < 3 s; 90 V (AC); 60 Hz
η	efficiency	> 89 %; average; measured at end of cable > 88 %; at 10 % load > 60 %; at 0.6 % load (= at 270 mW load)
$V_{line(reg)}$	line voltage regulation	< 1 %; 90 V (AC) to 264 V (AC); measured at the PCB
$V_{load(reg)}$	load voltage regulation	< 1 %; no-load to full load (2.3 A); measured at the PCB
EMI	conducted EMI	> 5 dB margin; according to CISPR22
$P_{o(opp)}$	OPP trigger level	55 W to 65 W; over full input voltage range
$V_{O(ovp)}$	overvoltage protection output voltage	< 24 V (DC)
V_{bi}	brownin voltage	75 V (AC) to 85 V (AC)
V_{bo}	brownout voltage	65 V (AC) to 75 V (AC); over full load range
$P_{i(shorted_output)}$	average input power at continuously shorted output	< 1 W; 264 V (AC)
T_{otp}	overtemperature protection temperature	105 °C; ± 5 °C; diode and NTC same temperature

4. Board photographs



Fig 2. TEA1833DB1361 demo board photograph - Top view

5. Performance

Performance figures are based on PCB design:

- Schematic version: v.3 (see [Figure 15](#))

5.1 Efficiency

Efficiency measurements are taken using an automated test program containing a temperature stability detection algorithm. The output voltage and output current are measured using a 4-wire current sense configuration directly at the PCB connector. Measurements are performed for:

- 115 V/60 Hz
- 230 V/50 Hz

Table 2. High load efficiency

Measured directly at the PCB; see [Section 5.1.1](#) for more information about how to calculate efficiency at end of cable.

Condition	Efficiency at specified load					
	10 %; 4.5 W	25 %; 11.25 W	50 %; 22.5 W	75 %; 33.75 W	100 %; 45 W	4-point average
115 V (AC)/60 Hz	89.21 %	90.61 %	90.36 %	90.01 %	89.21 %	90.05 %
230 V (AC)/50 Hz	88.41 %	90.61 %	90.57 %	90.70 %	90.64 %	90.63 %

Table 3. Low load efficiency

Measured directly at the PCB

Condition	Efficiency at specified load			
	0.2 W; 0.44 %	0.5 W; 1.11 %	1 W; 2.22 %	2 W; 4.44 %
115 V (AC)/60 Hz	78.44 %	86.00 %	88.30 %	89.48 %
230 V (AC)/50 Hz	70.21 %	81.31 %	84.93 %	86.91 %

After subtracting 0.975 % from the 4-point average efficiency result for cable losses, the board complies with all efficiency standards listed below.

Table 4. Efficiency standards

Standard	10 % load	4-point average (25 %; 50 %; 75 %; 100 %)
COC 2014	78.43 %	88.43 %
COC 2016	78.85 %	88.85 %
DoE 2008	-	84.26 %
DoE 2016	-	87.73 %
Energy Star 2.0	-	86.03 %

5.1.1 Cable loss

At full load, the cable loss reduces the efficiency by:

$$\Delta\eta = \frac{P_{cable}}{\eta \cdot P_{nom}} \cdot 100 \% = \frac{I_{nom}^2 \cdot R_{cable}}{\eta \cdot P_{nom}} \cdot 100 \% = \frac{(2.3 \text{ A})^2 \cdot R_{cable}}{0.9 \cdot 45 \text{ W}} \cdot 100 \% \quad (1)$$

$$= R_{cable} \cdot 13 \%$$

- The resistance of a 1.8 m 20 AWG cable is approximately 120 mΩ which reduces the efficiency at full load by $13\% \times 120\text{ m}\Omega = 1.56\%$.
- For the 4-point average, the result of the formula above must be multiplied by 0.625¹ so for the 4-point average the efficiency is reduced by 0.97%.
- At a 10% load, the influence of the cable can already be neglected.

Table 5. Cable loss for different types of cable

Cable thickness (AWG)	Cable length (m)	Resistance at 20 °C (mΩ)	Efficiency loss (4-point average) (%)
16	1.2	32	0.26
	1.8	47	0.39
18	1.2	50	0.41
	1.8	75	0.71
20	1.2	80	0.65
	1.8	120	0.97

5.1.2 Output diode

Replacing the 20 A Schottky diode (D5 in [Figure 15](#)) by a 40 A Schottky diode, for example, the Vishay V40100C can improve the efficiency about 0.5%.

5.2 No-load power consumption

Measurement details:

- Power meter Yokogawa WT210
- Integrated over 36 s
- AC source Agilent 6812B
- No probes or ground clips connected to board

Table 6. No-load power measurements

Input condition	No-load power
90 V (AC)/60 Hz	25.7 mW
115 V (AC)/60 Hz	28.5 mW
230 V (AC)/50 Hz	51.3 mW
264 V (AC)/50 Hz	62.0 mW

Table 7. No-load power requirements

Standard	No-load power
COC 2014	150 mW
COC 2016	75 mW
DoE 2008	300 mW
DoE 2016	100 mW
Energy Star 2.0	300 mW

1. At low output current, the cable losses rapidly decrease: reducing the output current by a factor 2 decreases the cable losses by a factor 4.

5.3 Load regulation

The output voltage as a function of load current is measured directly at the PCB and at the end of the cable at 115 V (AC)/60 Hz.

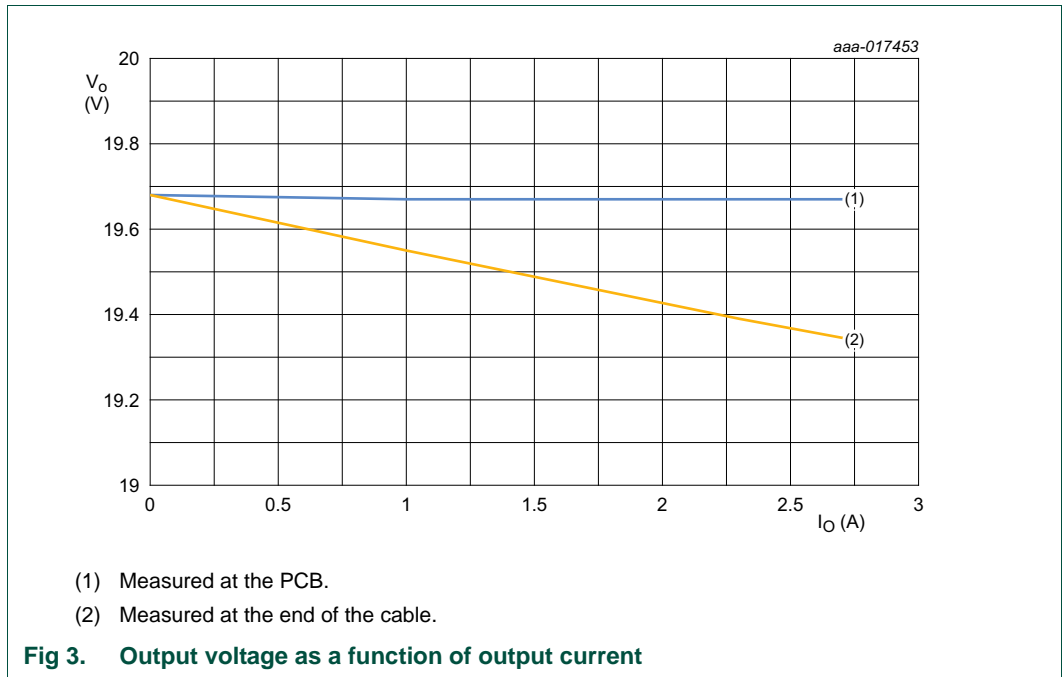

5.4 Line regulation

The output voltage as a function of mains input voltage is measured directly at the PCB at full load (2.3 A) and at 60 Hz.

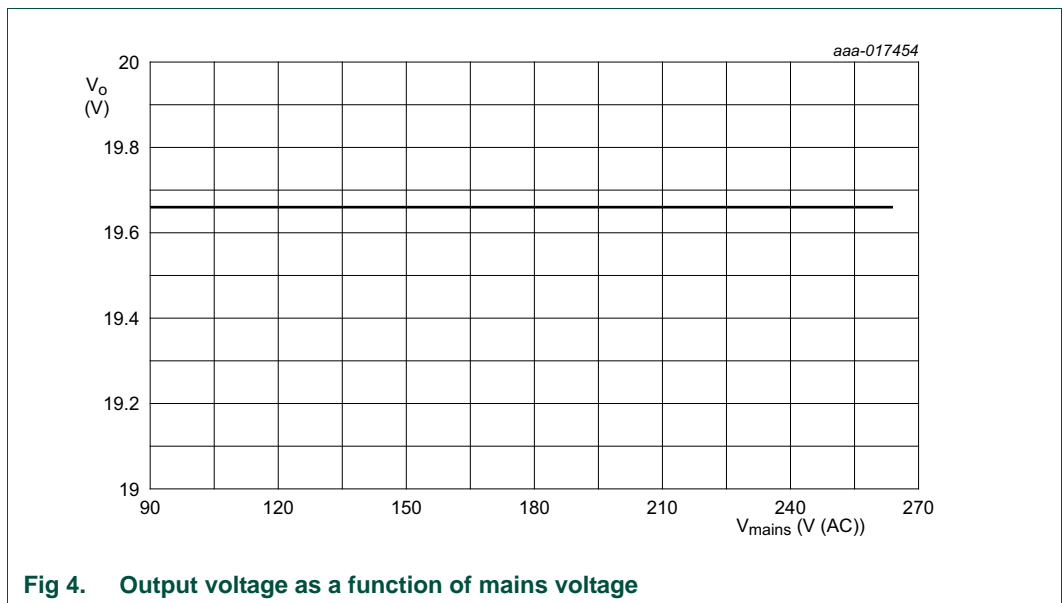

5.5 High/low line compensation

The maximum continuous output power is measured at the PCB as function of the mains voltage at 60 Hz.

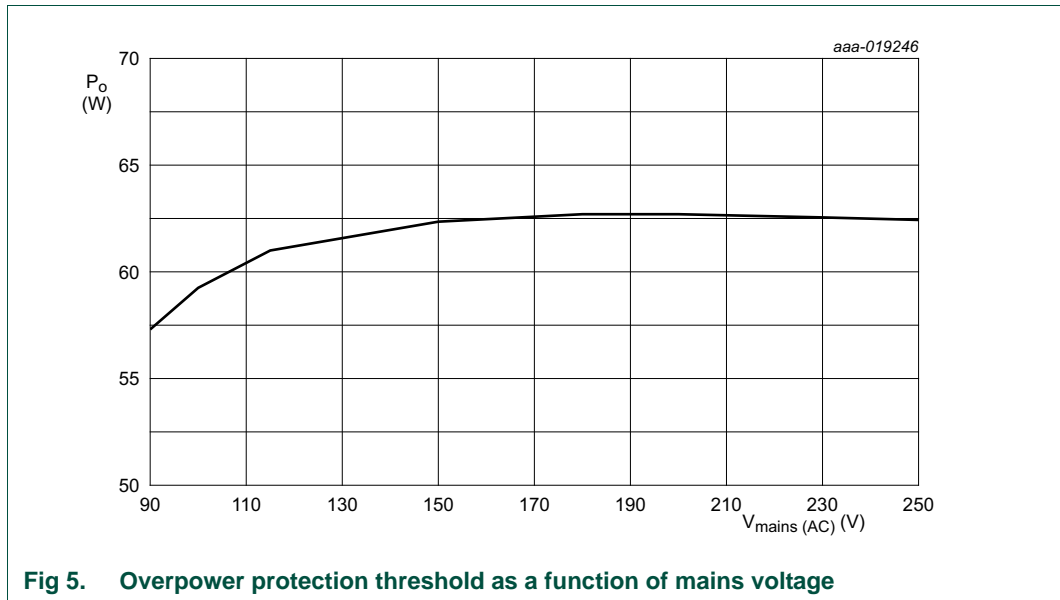

If necessary, the OPP level can be increased by decreasing resistors R11 and R12 to 0.47 Ω and increasing capacitor C1 to 82 μF. In that case resistor R13 must be increased to limit the output power at high input voltages. See the *TEA1833 application note* ([Ref. 3](#)) for more information about how to tune R13 and R27.

5.6 Peak power

5.6.1 Example 1

- Load: 200 % peak (4.6 A) for 2 ms when continuously running at 50 % load (10 ms)
- Input voltage: 100 V (AC); 47 Hz
- Output voltage: remains above 18 V (18.55 V)

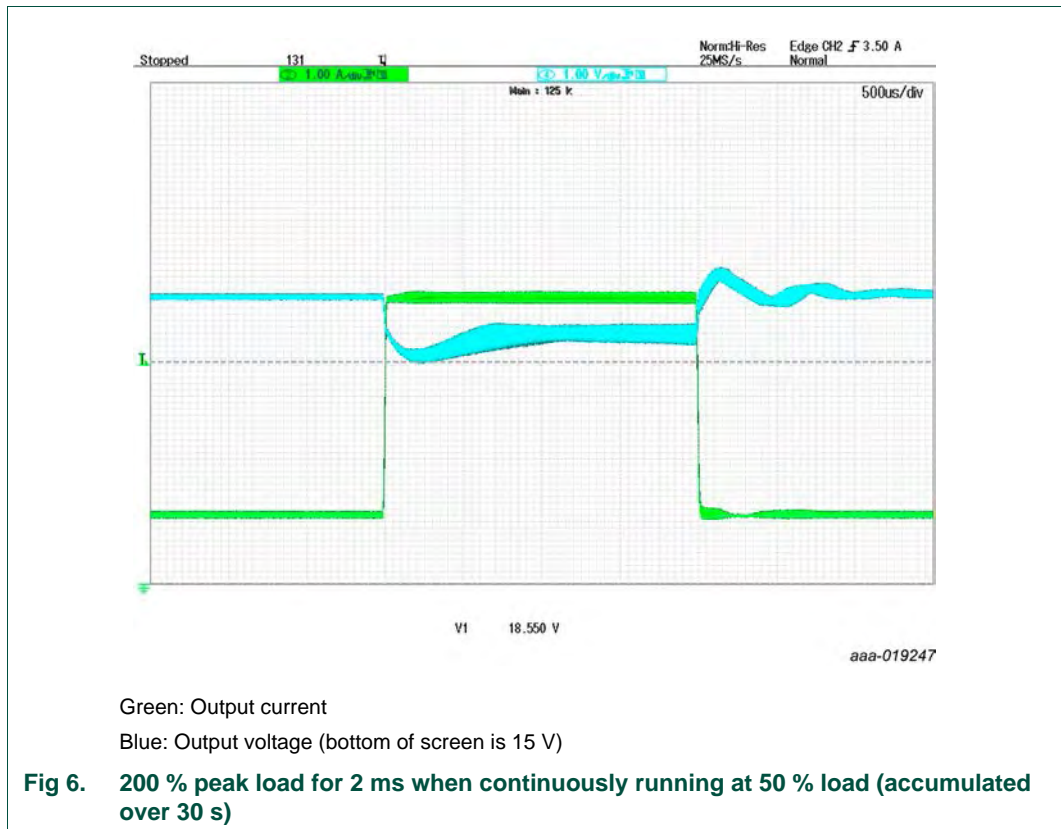

The output voltage was measured at end of the cable.

5.6.2 Example 2

- Load: 200 % peak (4.6 A) for 1 ms when continuously running at 100 % load (10 ms)
- Input voltage: 90 V (AC); 47 Hz
- Output voltage: remains above 17 V (17.66 V)

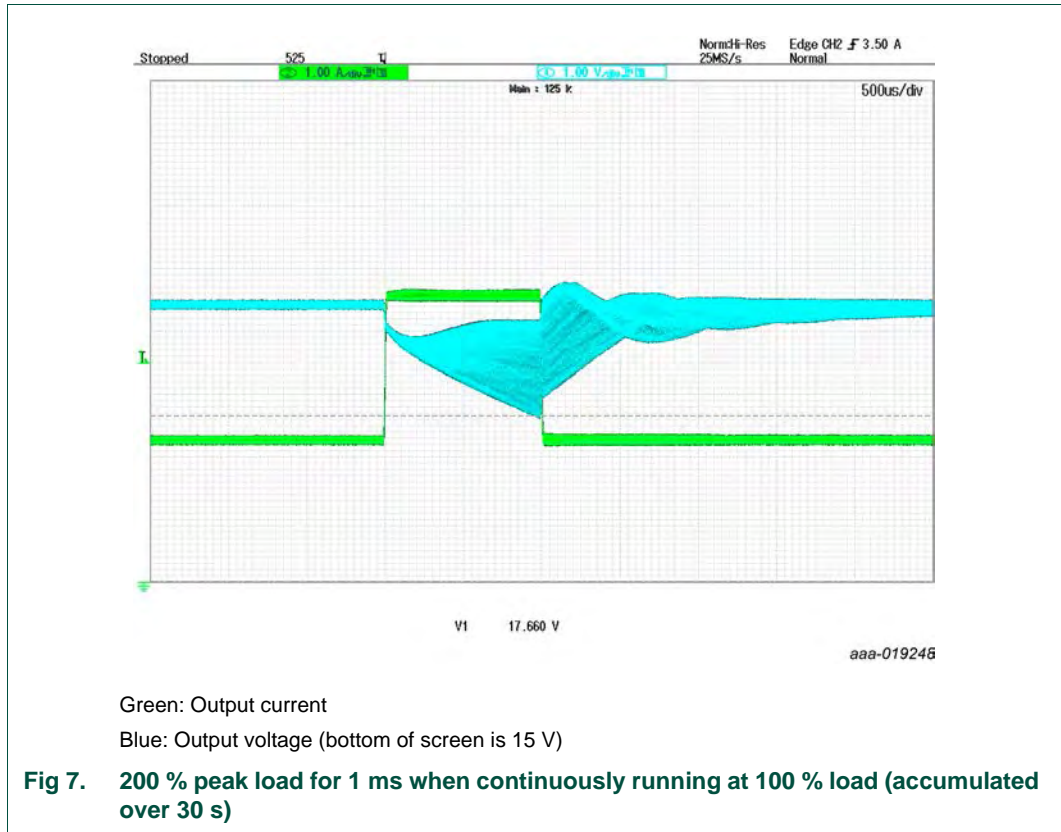

The output voltage was measured at end of the cable.

For an even higher or longer peak load, decrease current sense resistor and increase bulk capacitor (also increases the maximum continuous output power) or increase the output capacitor.

5.7 VCC voltage

The VCC voltage is measured at different input and loading conditions. It is within a safe margin of the UVLO level and the OVP level.

Table 8. VCC voltage

The two voltages are the minimum and the maximum value of the VCC ripple.

Condition	90 V (AC)/60 Hz	264 V (AC)/50 Hz
no-load	13.55 V to 18.05 V	13.85 V to 18.30 V
90 W peak load	27.10 V to 27.85 V	26.05 V to 26.75 V

5.8 Brownout and start-up level

Brownout and start-up level were measured at no-load and at full load in 0.5 V steps.

Table 9. Brownout and start-up level

Condition	Start-up voltage	Brownout voltage
no-load	83.5 V (AC)	73.5 V (AC)
full load (2.3 A)	83.5 V (AC)	75.0 V (AC)

5.9 OverVoltage Protection (OVP)

Applying a short circuit across the LED of the photocoupler (U2) creates an output overvoltage condition. The output voltage is measured directly at the PCB.

Table 10. Maximum output voltage

Condition	115 V (AC)/60 Hz	230 V (AC)/50 Hz
no-load	23.7 V	23.7 V
full load (2.3 A)	23.7 V	23.7 V

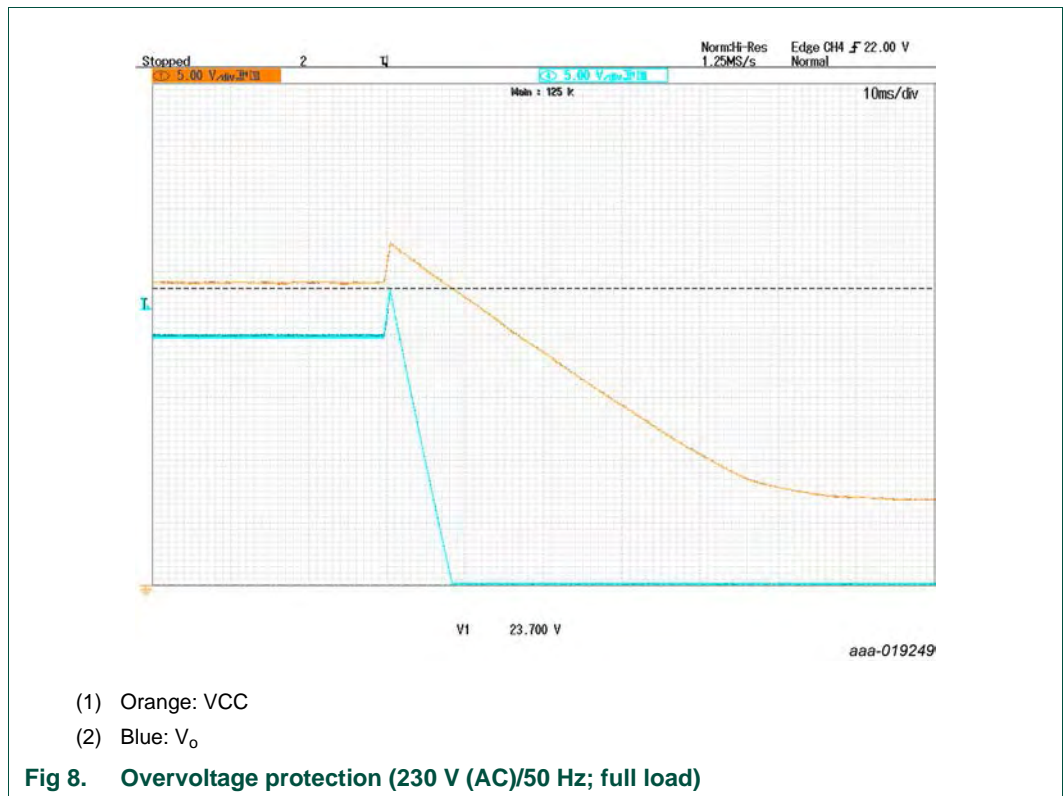

The OVP trigger level can be adjusted by changing resistor R27. For example, decreasing R27 to 68 kΩ decreases the OVP trigger level to 21.8 V.

5.10 Start-up time

The start-up time was measured without connecting any voltage probes. All capacitors were fully discharged before starting up.

Table 11. Start-up time measured at three input voltages

Input voltage	Start-up time
90 V (AC)/60 Hz	2.35 s
115 V (AC)/60 Hz	1.56 s
230 V (AC)/50 Hz	0.64 s

5.11 Start-up sequence

Figure 9 and Figure 10 show waveforms of some essential voltages. These waveforms were captured during start-up at full load.

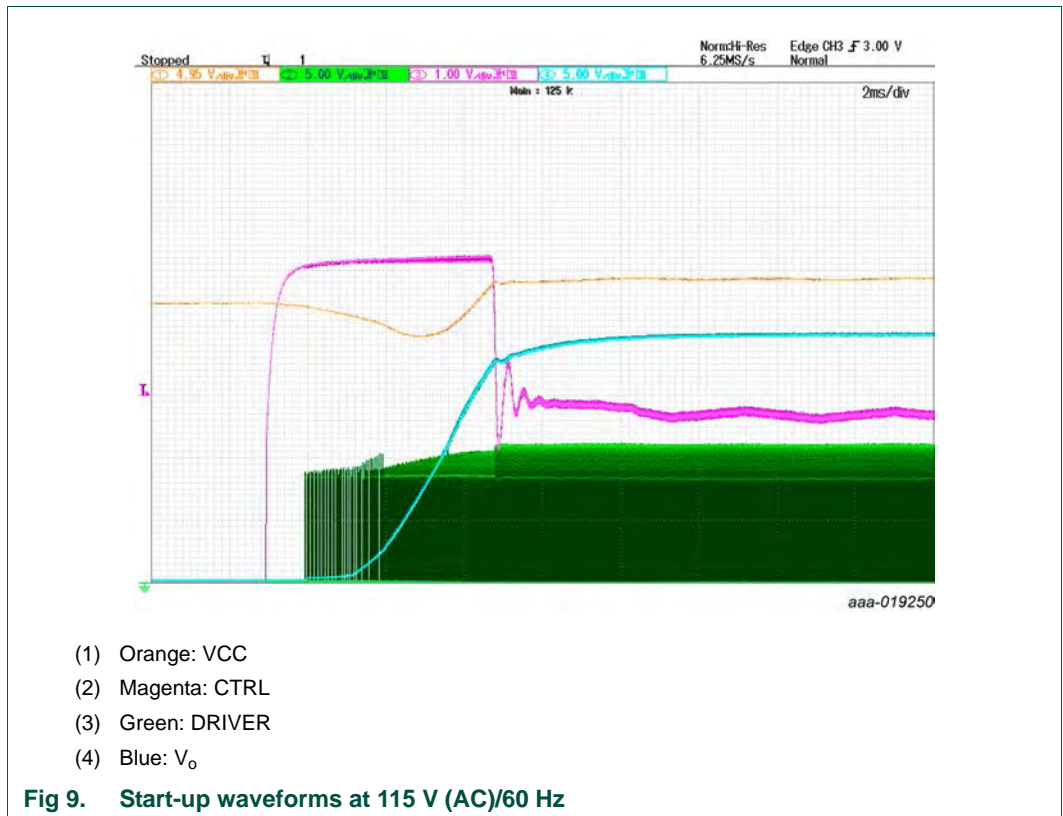



5.12 Hold-up time

The hold-up time at 115 V (AC)/50 Hz is 9.5 ms.

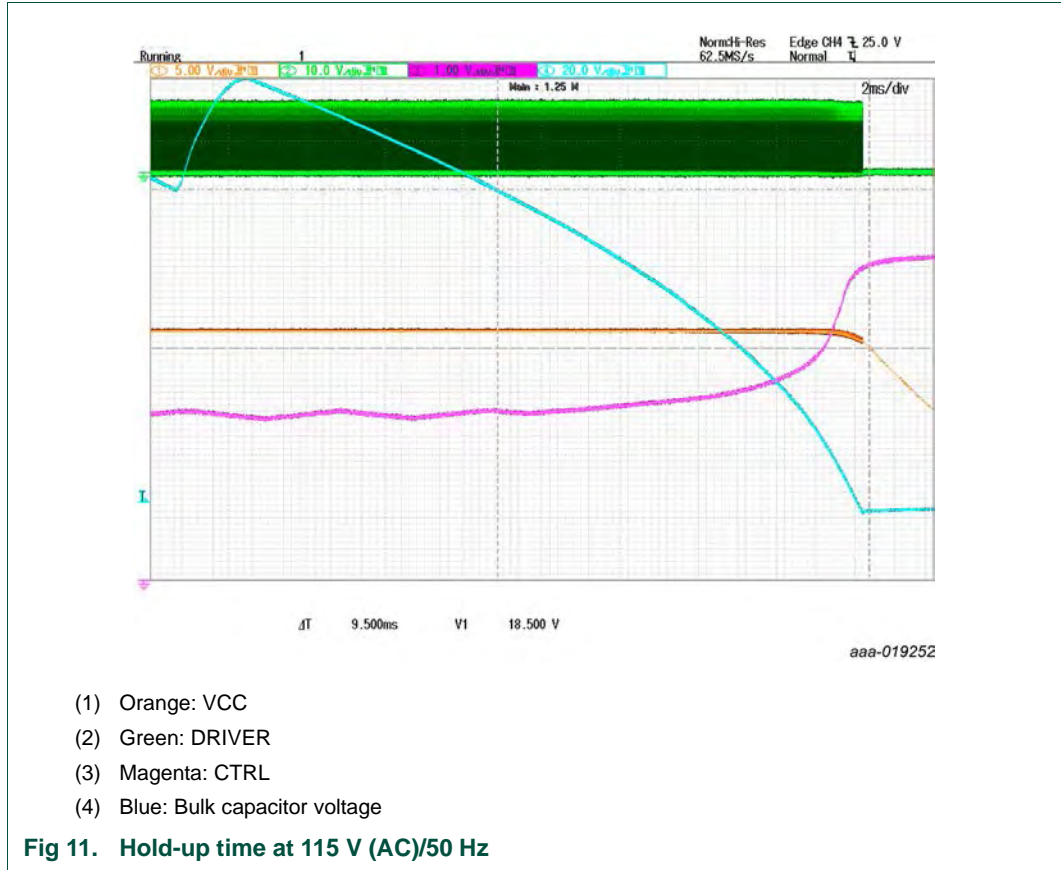

The hold-up time was measured from the last valley of the bulk capacitor ripple (worst case moment for mains interruption) until the output voltage starts to drop (drops to below 18.5 V).

5.13 Average input power at continuously shorted output

Measurement details:

- Output was shorted at the end of the cable
- Power meter Yokogawa WT210
- Current range 5 A
- Integration time 36 s

Table 12. Input power at continuously shorted output

Condition	Input power
90 V (AC)/60 Hz	167 mW
115 V (AC)/60 Hz	179 mW
230 V (AC)/50 Hz	596 mW
264 V (AC)/50 Hz	721 mW

5.14 Output ripple and noise

Measured at full load with a 10 μ F/50 V capacitor (United Chemi Con; KY series) at end of the cable. The oscilloscope bandwidth was limited to 20 MHz.

Table 13. Output ripple and noise

Condition	V _{o(ripple)} (p-p)
90 V (AC)	81 mV (p-p)
264 V (AC)	81 mV (p-p)

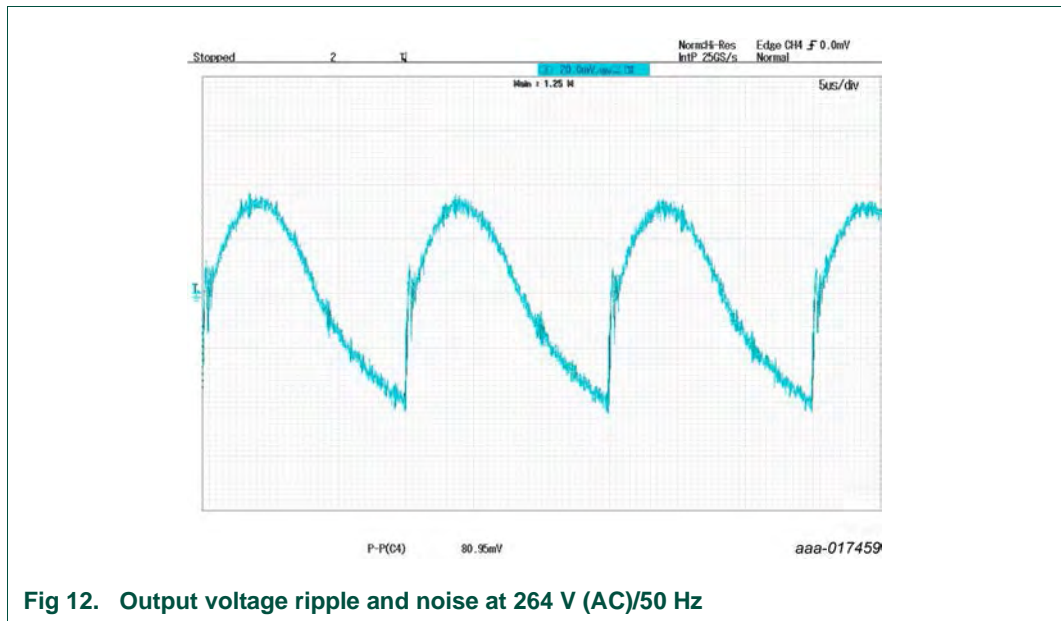

Fig 12. Output voltage ripple and noise at 264 V (AC)/50 Hz

5.15 OverTemperature Protection (OTP)

The external OTP triggers at 105 °C, measured in an oven at 115 V (AC)/60 Hz at no-load operation.

5.16 EMI performance

Conducted EMI measurement details:

- Full load (passive load 8.33 Ω at end of cable)
- Supply voltage 115 V (AC) and 230 V (AC)
- Frequency range 150 kHz to 30 MHz
- Test receiver Rohde & Schwarz ESPI3
- Line impedance stabilization network Rohde & Schwarz ENV216

Remark: In [Figure 13](#) and [Figure 14](#), the blue line is the peak measurement result and the black line is the average measurement result.

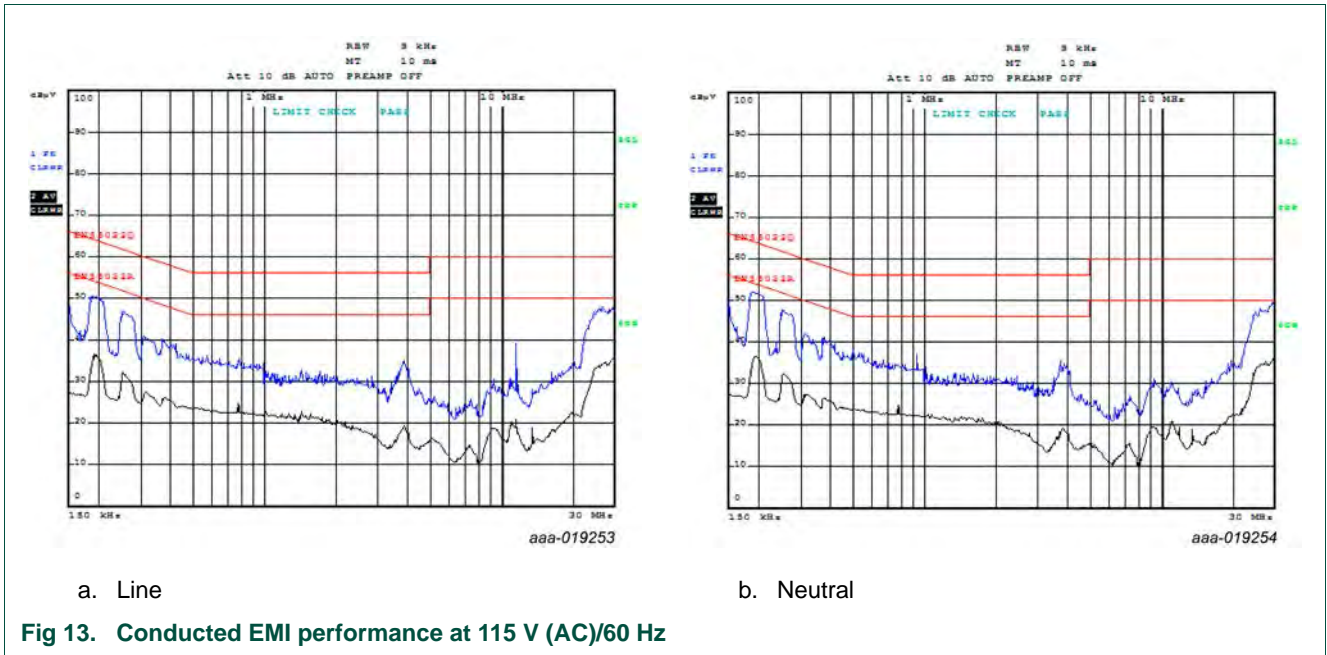

Fig 13. Conducted EMI performance at 115 V (AC)/60 Hz

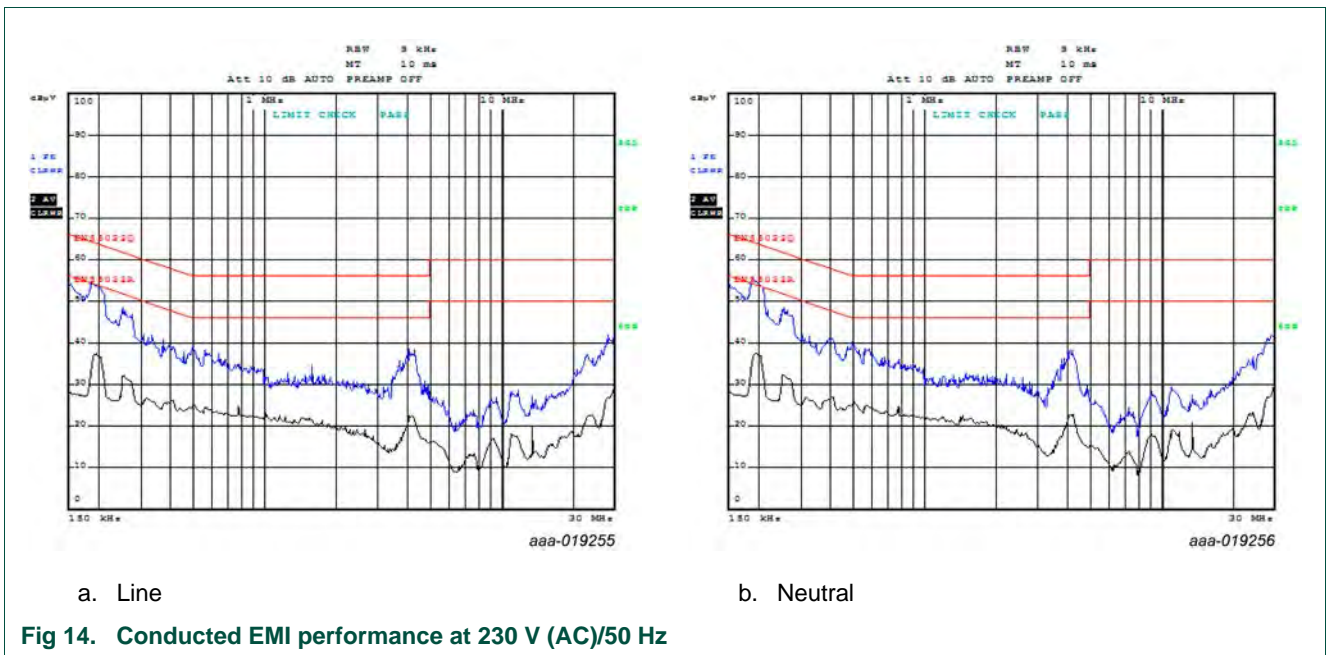

Fig 14. Conducted EMI performance at 230 V (AC)/50 Hz

6. Schematic

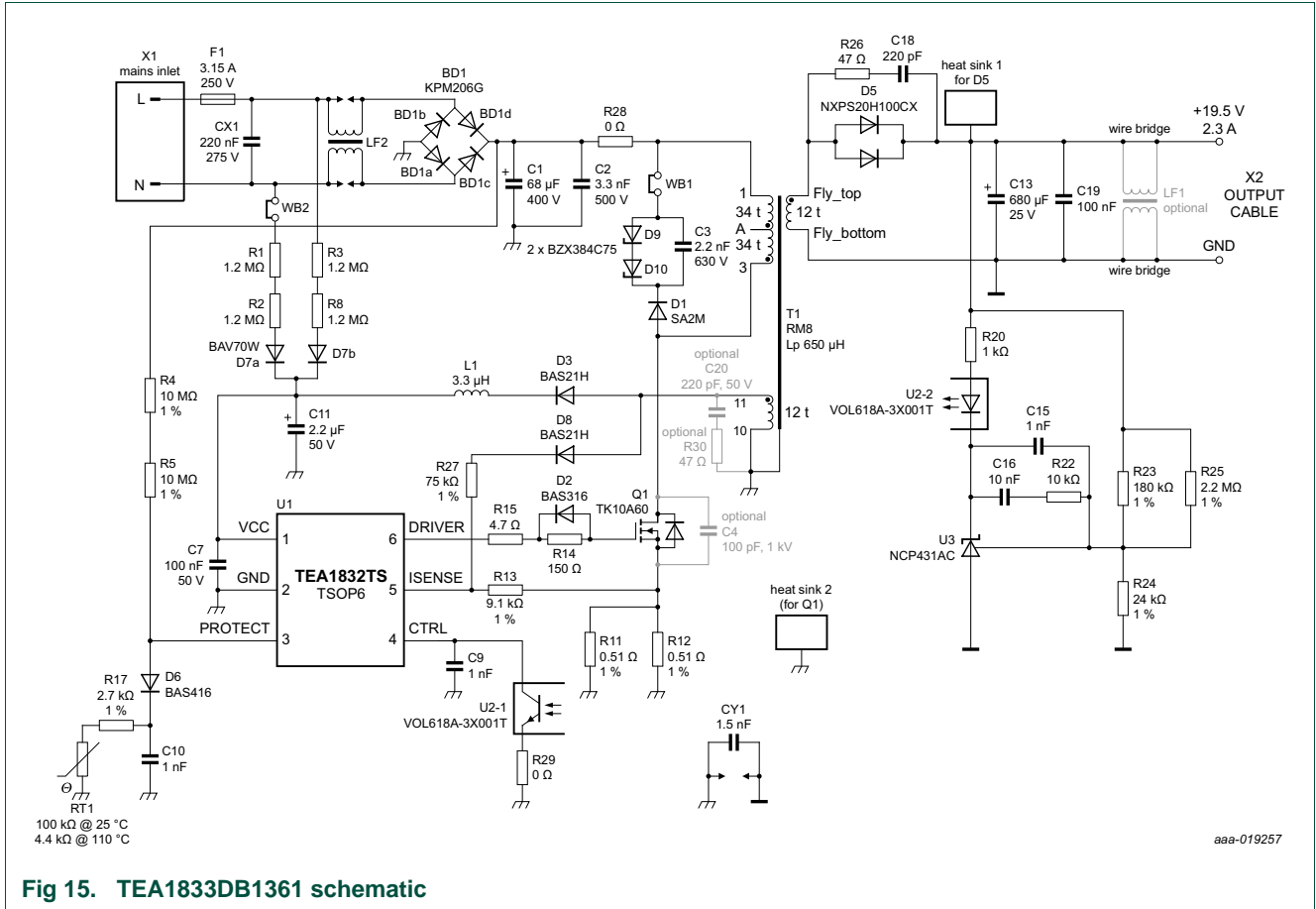

Fig 15. TEA1833DB1361 schematic

7. Bill Of Materials (BOM)

Table 14. TEA1833DB1361 bill of materials

Reference	Description and values	Part number	Manufacturer
BC1	not mounted; ferrite core; on pin CY1	74270073	Würth Elektronik
BD1	bridge diode; 2 A; 600 V	KBP206G	Diodes Inc.
C1	capacitor; 68 μ F; 400 V; 105 $^{\circ}$ C	400BXW68MEFC18X20	Rubycon
C2	capacitor; 3.3 nF; 1 kV; X7R; 1206	-	-
C3	capacitor; 2.2 nF; 630 V; X7R; 1206	-	-
C4	capacitor; not mounted; 100 pF; 1 kV; X7R; 1206	-	-
C7	capacitor; 100 nF; 50 V; X7R; 0603	-	-
C9; C10; C15	capacitor; 1 nF; 50 V; X7R; 0603	-	-
C11	capacitor; 2.2 μ F; 50 V; 105 $^{\circ}$ C; 5 mm \times 11 mm	50YXJ2R2MTA5X11	Rubycon
C13	capacitor; 680 μ F; 25 V; 105 $^{\circ}$ C; 10 mm \times 20 mm	EKZE250ELL681MJ20S	United Chemi Con
C16	capacitor; 10 nF; 50 V; X7R; 0603	-	-
C18	capacitor; 220 pF; 100 V; NPO; 0805	-	-
C19	capacitor; 100 nF; 50 V; X7R; 1206	-	-
C20	capacitor; not mounted; 220 pF; 50 V; X7R; 0603	-	-
CX1	capacitor; 220 nF; 275 V (AC); X2	-	HJC
CY1	capacitor; 1.5 nF; 250 V (AC); Y1	DE1E3KX152MA5BA01	Murata
D1	diode; 1 kV; 2 A	SA2M-E3/61T	Vishay
D2	diode; 100 V; 250 mA	BAS316	NXP Semiconductors
D3; D8	diode; 200 V; 200 mA	BAS21H	NXP Semiconductors
D5	diode; Schottky; 100 V; 2 \times 10 A; TO220	NXPS20H100CX	NXP Semiconductors
D6	diode; 85 V; 200 mA	BAS416	NXP Semiconductors
D7	diode; dual; common cathode; 85 V; 100 mA	BAV70W	NXP Semiconductors
D9; D10	diode; Zener; 75 V; 250 mW; SOD323F	BZX84J-B75	NXP Semiconductors
F1	fuse; slow blow; 3.15 A; 250 V (AC)	MST 3.15A 250V	Multicomp
HS1	heat sink for Q1	-	-
HS2	heat sink for D5	-	-
L1	inductor; 3.3 μ H; 1.2 A	LQM2HPN3R3MG0L	Murata
LF1	choke; common mode; not mounted; shorted by wire bridge; diameter = 0.8 mm; pitch 5.08 mm	-	-
LF2	choke; common mode; 2 \times 6.8 mH	B82721K2122N20	EPCOS
M1; M2	screw; M3 \times 8; for mounting Q1 and D5	-	-
M3; M4	spring washer; M3; for mounting Q1 and D5	-	-
M5; M6	nut; M3; for mounting Q1 and D5	-	-
Q1	MOSFET; N-channel; 600 V; 10 A	TK10A60D	Toshiba

Table 14. TEA1833DB1361 bill of materials ...continued

Reference	Description and values	Part number	Manufacturer
R1; R2; R3; R8	resistor; 1.2 M Ω ; 1206	-	-
R5; R6	resistor; 10 M Ω ; 1 %; 1206	-	-
R11; R12	resistor; 0.51 Ω ; 1 %; 500 mW; 1206	-	-
R13	resistor; 9.1 k Ω ; 1 %; 0603	-	-
R14	resistor; 150 Ω ; 0805	-	-
R15	resistor; 4.7 Ω ; 0805	-	-
R17	resistor; 2.7 k Ω ; 1 %; 0603	-	-
R20	resistor; 1.0 k Ω ; 0805	-	-
R22	resistor; 10 k Ω ; 0603	-	-
R23	resistor; 180 k Ω ; 1 %; 0603	-	-
R24	resistor; 24 k Ω ; 1 %; 0603	-	-
R25	resistor; 2.2 M Ω ; 0603	-	-
R26	resistor; 47 Ω ; 0805	-	-
R27	resistor; 75 k Ω ; 1 %; 0603	-	-
R28	resistor; 0 Ω ; 2512	-	-
R29	resistor; 0 Ω ; 0603	-	-
R30	resistor; not mounted; 47 Ω ; 0603	-	-
RT1	resistor; NTC; 100 k Ω	NTCLE100E3104JB0	Vishay
T1	transformer; RM8 (see Section 9)	TF-RM080-207R	Shenzhen Belta
U1	flyback controller	TEA1833TS	NXP Semiconductors
U2	photocoupler; CTR = 100 % to 200 % at IF = 1 mA	VOL618A-3X001T	Vishay
U3	shunt regulator; 2.5 V	NCP431ACSNT1G	ON Semiconductor
WB1; WB2	wire bridge; diameter = 0.8 mm; pitch = 5.08 mm	-	-
X1	mains inlet	770W-X2/10	Qualtek
X2	output cable; 20 AWG; 1.8 m	-	-

9. Transformer specification

- Manufacturer: Shenzhen Belta Technology Co. Ltd.
- Shenzhen Belta part number: TF-RM080-207R

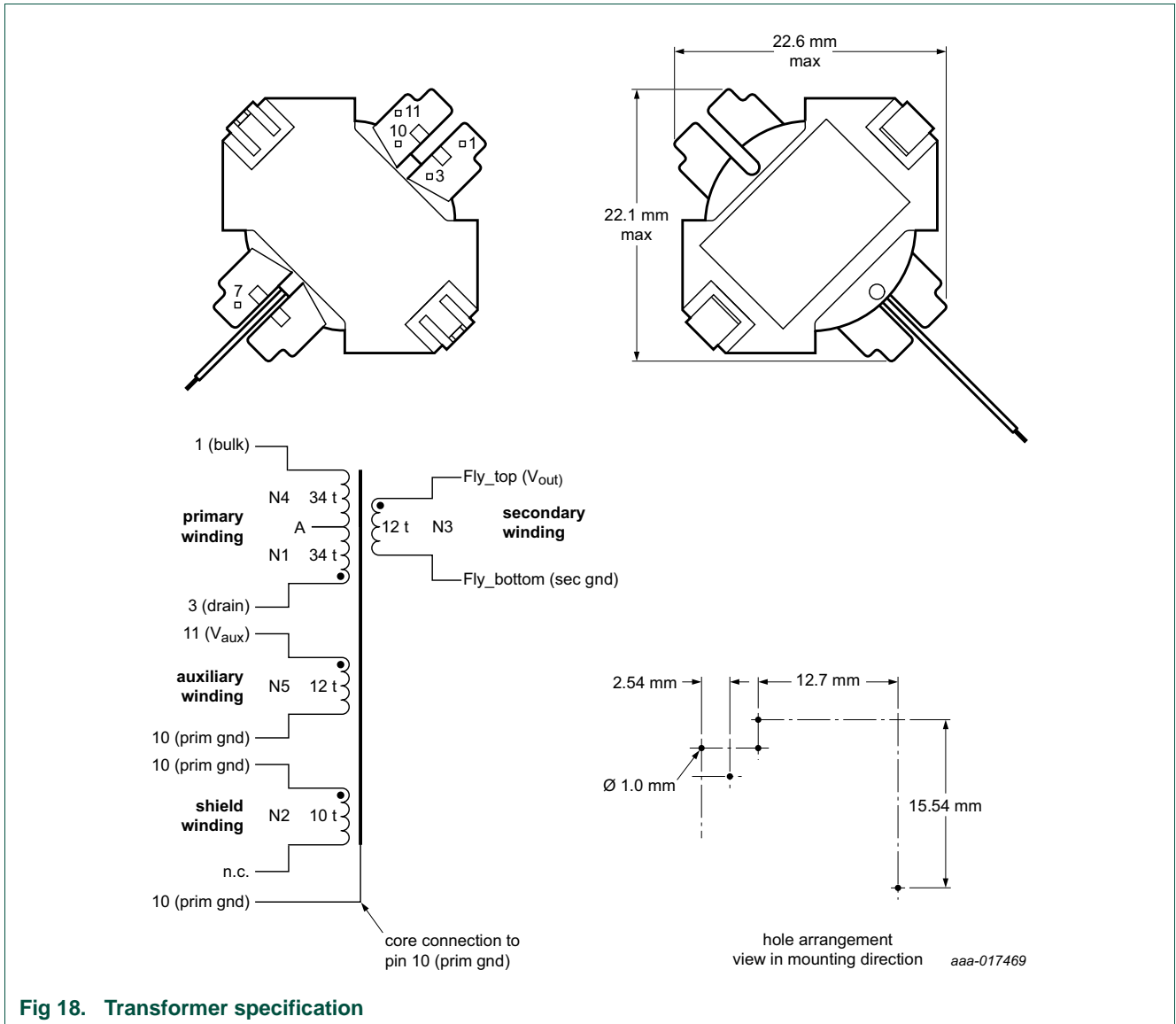

Table 15. Electrical characteristics

Parameter	Value	Conditions
DC resistance	1110 mΩ	primary
	45 mΩ	secondary
	527 mΩ	auxiliary
primary inductance	650 μH	10 kHz
leakage inductance ^[1]	5.8 μH	100 kHz; 100 mV (RMS)
winding ratio	prim:sec:auxiliary	5.67:1.0:1.0

[1] Secondary and auxiliary winding shorted

Table 16. Winding specification

Winding ^[1]	Wire	Turns	Start	Finish	Purpose
N1	1 × 0.224 mm	34	pin 3	A ^[2]	primary
N2	4 × 0.18 mm	10	pin 10	-	shield
N3	1 × 0.5 mm TEX-E	12	fly top	fly bottom	secondary
N4	1 × 0.224 mm	34	A ^[2]	pin 1	primary
N5	1 × 0.15 mm	12	pin 10	pin 11	auxiliary

[1] 1 layer of mylar tape after each winding.

[2] Intermediate connection A is not connected to a pin.

10. Abbreviations

Table 17. Abbreviations

Acronym	Description
SMPS	Switched-Mode Power Supply
OCP	OverCurrent Protection
OPP	OverPower Protection
OTP	OverTemperature Protection
UVLO	UnderVoltage LockOut
LED	Light-Emitting Diode
OVP	OverVoltage Protection
EMI	ElectroMagnetic Interference

11. References

- [1] **TEA1833TS data sheet** — GreenChip SMPS control IC
- [2] **TEA1833LTS data sheet** — GreenChip SMPS control IC
- [3] **AN11675 application note** — GreenChip TEA1833(L)TS fixed frequency flyback controller

12. Legal information

12.1 Definitions

Draft — The document is a draft version only. The content is still under internal review and subject to formal approval, which may result in modifications or additions. NXP Semiconductors does not give any representations or warranties as to the accuracy or completeness of information included herein and shall have no liability for the consequences of use of such information.

12.2 Disclaimers

Limited warranty and liability — Information in this document is believed to be accurate and reliable. However, NXP Semiconductors does not give any representations or warranties, expressed or implied, as to the accuracy or completeness of such information and shall have no liability for the consequences of use of such information. NXP Semiconductors takes no responsibility for the content in this document if provided by an information source outside of NXP Semiconductors.

In no event shall NXP Semiconductors be liable for any indirect, incidental, punitive, special or consequential damages (including - without limitation - lost profits, lost savings, business interruption, costs related to the removal or replacement of any products or rework charges) whether or not such damages are based on tort (including negligence), warranty, breach of contract or any other legal theory.

Notwithstanding any damages that customer might incur for any reason whatsoever, NXP Semiconductors' aggregate and cumulative liability towards customer for the products described herein shall be limited in accordance with the *Terms and conditions of commercial sale* of NXP Semiconductors.

Right to make changes — NXP Semiconductors reserves the right to make changes to information published in this document, including without limitation specifications and product descriptions, at any time and without notice. This document supersedes and replaces all information supplied prior to the publication hereof.

Suitability for use — NXP Semiconductors products are not designed, authorized or warranted to be suitable for use in life support, life-critical or safety-critical systems or equipment, nor in applications where failure or malfunction of an NXP Semiconductors product can reasonably be expected to result in personal injury, death or severe property or environmental damage. NXP Semiconductors and its suppliers accept no liability for inclusion and/or use of NXP Semiconductors products in such equipment or applications and therefore such inclusion and/or use is at the customer's own risk.

Applications — Applications that are described herein for any of these products are for illustrative purposes only. NXP Semiconductors makes no representation or warranty that such applications will be suitable for the specified use without further testing or modification.

Customers are responsible for the design and operation of their applications and products using NXP Semiconductors products, and NXP Semiconductors accepts no liability for any assistance with applications or customer product design. It is customer's sole responsibility to determine whether the NXP Semiconductors product is suitable and fit for the customer's applications and products planned, as well as for the planned application and use of customer's third party customer(s). Customers should provide appropriate design and operating safeguards to minimize the risks associated with their applications and products.

NXP Semiconductors does not accept any liability related to any default, damage, costs or problem which is based on any weakness or default in the customer's applications or products, or the application or use by customer's third party customer(s). Customer is responsible for doing all necessary testing for the customer's applications and products using NXP Semiconductors products in order to avoid a default of the applications and the products or of the application or use by customer's third party customer(s). NXP does not accept any liability in this respect.

Export control — This document as well as the item(s) described herein may be subject to export control regulations. Export might require a prior authorization from competent authorities.

Evaluation products — This product is provided on an "as is" and "with all faults" basis for evaluation purposes only. NXP Semiconductors, its affiliates and their suppliers expressly disclaim all warranties, whether express, implied or statutory, including but not limited to the implied warranties of non-infringement, merchantability and fitness for a particular purpose. The entire risk as to the quality, or arising out of the use or performance, of this product remains with customer.

In no event shall NXP Semiconductors, its affiliates or their suppliers be liable to customer for any special, indirect, consequential, punitive or incidental damages (including without limitation damages for loss of business, business interruption, loss of use, loss of data or information, and the like) arising out of the use of or inability to use the product, whether or not based on tort (including negligence), strict liability, breach of contract, breach of warranty or any other theory, even if advised of the possibility of such damages.

Notwithstanding any damages that customer might incur for any reason whatsoever (including without limitation, all damages referenced above and all direct or general damages), the entire liability of NXP Semiconductors, its affiliates and their suppliers and customer's exclusive remedy for all of the foregoing shall be limited to actual damages incurred by customer based on reasonable reliance up to the greater of the amount actually paid by customer for the product or five dollars (US\$5.00). The foregoing limitations, exclusions and disclaimers shall apply to the maximum extent permitted by applicable law, even if any remedy fails of its essential purpose.

Safety of high-voltage evaluation products — The non-insulated high voltages that are present when operating this product, constitute a risk of electric shock, personal injury, death and/or ignition of fire. This product is intended for evaluation purposes only. It shall be operated in a designated test area by personnel that is qualified according to local requirements and labor laws to work with non-insulated mains voltages and high-voltage circuits.

The product does not comply with IEC 60950 based national or regional safety standards. NXP Semiconductors does not accept any liability for damages incurred due to inappropriate use of this product or related to non-insulated high voltages. Any use of this product is at customer's own risk and liability. The customer shall fully indemnify and hold harmless NXP Semiconductors from any liability, damages and claims resulting from the use of the product.

Translations — A non-English (translated) version of a document is for reference only. The English version shall prevail in case of any discrepancy between the translated and English versions.

12.3 Trademarks

Notice: All referenced brands, product names, service names and trademarks are the property of their respective owners.

GreenChip — is a trademark of NXP Semiconductors N.V.

13. Contents

1	Introduction	3
1.1	Features	3
2	Safety warning	4
3	Power supply specification	5
4	Board photographs	6
5	Performance	7
5.1	Efficiency	7
5.1.1	Cable loss	7
5.1.2	Output diode	8
5.2	No-load power consumption	8
5.3	Load regulation	9
5.4	Line regulation	9
5.5	High/low line compensation	10
5.6	Peak power	11
5.6.1	Example 1	11
5.6.2	Example 2	12
5.7	VCC voltage	12
5.8	Brownout and start-up level	13
5.9	OverVoltage Protection (OVP)	13
5.10	Start-up time	14
5.11	Start-up sequence	14
5.12	Hold-up time	16
5.13	Average input power at continuously shorted output	16
5.14	Output ripple and noise	17
5.15	OverTemperature Protection (OTP)	17
5.16	EMI performance	17
6	Schematic	19
7	Bill Of Materials (BOM)	20
8	PCB layout	22
9	Transformer specification	23
10	Abbreviations	25
11	References	25
12	Legal information	26
12.1	Definitions	26
12.2	Disclaimers	26
12.3	Trademarks	26
13	Contents	27

Please be aware that important notices concerning this document and the product(s) described herein, have been included in section 'Legal information'.

© NXP Semiconductors N.V. 2015. All rights reserved.

For more information, please visit: <http://www.nxp.com>
 For sales office addresses, please send an email to: salesaddresses@nxp.com

Date of release: 26 August 2015
 Document identifier: UM10899