

High-performance Regulator IC Series for PCs

# Termination Regulators for DDR-SDRAMs



**BD3533F/FVM/EKN(1A),BD3531F(1.5A),BD3532F/EFV/KN(3A)**

### ●Description

BD3533/31/32 is a termination regulator compatible with JEDEC DDR-SDRAM, which functions as a linear power supply incorporating an N-channel MOSFET and provides a sink/source current capability up to 1A, 1.5A, and 3A respectively. A built-in high-speed OP-AMP specially designed offers an excellent transient response. Requires 3.3 volts or 5.0 volts as a bias power supply to drive the N-channel MOSFET. Has an independent reference voltage input pin (VDDQ) and an independent feedback pin (VTTs) to maintain the accuracy in voltage required by JEDEC, and offers an excellent output voltage accuracy and load regulation. Also has a reference power supply output pin (VREF) for DDR-SDRAM or a memory controller. When EN pin turns to "Low", VTT output becomes "Hi-Z" while VREF output is kept unchanged, compatible with "Self Refresh" state of DDR-SDRAM.

### ●Features

- 1) Incorporates a push-pull power supply for termination (VTT)
- 2) Incorporates a reference voltage circuit (VREF)
- 3) Incorporates an enabler
- 4) Incorporates an undervoltage lockout (UVLO)
- 5) Employs SOP8 package
- 6) Employs MSOP8 package
- 7) Employs HQFN20V package
- 8) Employs HTSSOP-B20 package
- 9) Employs VQFN28V package
- 10) Incorporates a thermal shutdown protector (TSD)
- 11) Operates with input voltage from 2.7 to 5.5 volts
- 12) Compatible with Dual Channel (DDR-II)

### ●Use

Power supply for DDR I/II - SDRAM

### ●Line up

Parameter	BD3533F/FVM/EKN	BD3531F	BD3532F/EFV/KN
Output Current	±1.0A	±1.5A	±3A
Vcc Range	2.7V~5.5V	4.5V~5.5V	4.3~5.5V
Soft Start Function	○	×	○
Temperature	-20~100°C	-10~100°C	-40~100°C
Package	SOP8/MSOP8/HQFN20V	SOP8	SOP8/HTSSOP-B20/VQFN28

●ABSOLUTE MAXIMUM RATINGS

◎BD3533F/FVM/EKN

Parameter	Symbol	BD3533F	BD3533FVM	BD3533EKN	Unit
Input Voltage	VCC	7 *1*2	7 *1*2	7 *1*2	V
Enable Input Voltage	VEN	7 *1*2	7 *1*2	7 *1*2	V
Termination Input Voltage	VTT_IN	7 *1*2	7 *1*2	7 *1*2	V
VDDQ Reference Voltage	VDDQ	7 *1*2	7 *1*2	7 *1*2	V
Output Current	ITT	3	1	3	A
Power Dissipation1	Pd1	560 *3	437.5 *5	500 *6	mW
Power Dissipation2	Pd2	690 *4	-	750 *7	mW
Power Dissipation3	Pd3	-	-	1750 *8	mW
Power Dissipation4	Pd4	-	-	2000 *9	mW
Operating Temperature Range	Topr	-20~+100	-20~+100	-20~+100	°C
Storage Temperature Range	Tstg	-55~+150	-55~+150	-55~+150	°C
Maximum Junction Temperature	Tjmax	+150	+150	+150	°C

\*1 Should not exceed Pd.

\*2 Instantaneous surge voltage, back electromotive force and voltage under less than 10% duty cycle.

\*3 Reduced by 4.48mW for each increase in Ta of 1°C over 25°C(With no heat sink).

\*4 Reduced by 5.52mW for each increase in Ta of 1°C over 25°C(When mounted on a board 70mm×70mm×1.6mm Glass-epoxyPCB).

\*5 Reduced by 3.5mW for each increase in Ta of 1°C over 25°C(With no heat sink).

\*6 Ta≥25°C(no heat sink)4mW/°C increase.

\*7 Ta≥25°C(when mounted on 70mm x 70mm x 1.6mm Glass-epoxy PCB which does not have copper on the back side).

\*8 Ta≥25°C(when mounted on 70mm x 70mm x 1.6mm Glass-epoxy PCB which has 1 layer ( 60mm x 60mm ) of copper on the back side)14mW/°C increase.

\*9 Ta≥25°C(When mounted on board 70mm x 70mm x 1.6mm Glass-epoxy PCB which has 2 layers ( 60mm x 60mm ) of copper on the back side )16mW/°C increase.

◎BD3531F

Parameter	Symbol	Limit	Unit
Input Voltage	VCC	7 *1	V
EN Input Voltage	VEN	7 *1	V
Termination Input Voltage	VTT_IN	7 *1	V
VDDQ Reference Voltage	VDDQ	7 *1	V
Output Current	ITT	3	A
Power Dissipation1	Pd1	560 *2	mW
Power Dissipation2	Pd2	690 *3	mW
Operating Temperature Range	Topr	-10~	°C
Storage Temperature Range	Tstg	-55~	°C
Maximum Junction Temperature	Tjmax	+150	°C

\*1 Should not exceed Pd.

\*2 Reduced by 4.48mW for each increase in Ta of 1°C over 25°C(With no heat sink).

\*3 Reduced by 5.52mW for each increase in Ta of 1°C over 25°C(When mounted on a board 70mm×70mm×1.6mm Glass-epoxyPCB).

◎BD3532F/EFV/KN

Parameter	Symbol	BD3532F	BD3532EFV	BD3532KN	Unit
Input Voltage	VCC	7 *1	7 *1	7 *1	V
Enable Input Voltage	VEN	7 *1	7 *1	7 *1	V
Termination Input Voltage	VTT_IN	7 *1	7 *1	7 *1	V
VDDQ Reference Voltage	VDDQ	7 *1	7 *1	7 *1	V
Output Current	ITT	3	3	3	A
Power Dissipation1	Pd1	560 *2	-	460 *5	mW
Power Dissipation2	Pd2	690 *3	1000 *4	725 *6	mW
Operating Temperature Range	Topr	-40~+100	-40~+100	-40~+100	°C
Storage Temperature Range	Tstg	-55~+150	-55~+150	-55~+150	°C
Maximum Junction Temperature	Tjmax	+150	+150	+150	°C

\*1 Should not exceed Pd.

\*2 Reduced by 4.48mW for each increase in Ta of 1°C over 25°C(With no heat sink).

\*3 Reduced by 5.52mW for each increase in Ta of 1°C over 25°C(When mounted on a board 70mm×70mm×1.6mm Glass-epoxyPCB).

\*4 Reduced by 8.0mW for each increase in Ta of 1°C over 25°C(When mounted on a board 70mm×70mm×1.6mm Glass-epoxyPCB).

\*5 Reduced by 3.68mW for each increase in Ta of 1°C over 25°C(With no heat sink).

\*6 Reduced by 5.80mW for each increase in Ta of 1°C over 25°C(When mounted on a board 70mm×70mm×1.6mm Glass-epoxyPCB).

●RECOMMENDED OPERATING CONDITIONS

◎BD3533F/FVM/EKN(Ta=25°C)

Parameter	Symbol	MIN	MAX	Unit
Input Voltage	VCC	2.7	5.5	V
Termination Input Voltage	VTT_IN	1.0	5.5	V
VDDQ Reference Voltage	VDDQ	1.0	2.75	V
Enable Input Voltage	VEN	-0.3	5.5	V

◎BD3531F(Ta=25°C)

Parameter	Symbol	MIN	MAX	Unit
Input Voltage	VCC	4.5	5.5	V
Termination Input Voltage	VTT_IN	1.0	5.5	V
EN Input Voltage	VEN	-0.3	5.5	V

◎BD3532F/EFV/KN(Ta=25°C)

Parameter	Symbol	MIN	MAX	Unit
Input Voltage	VCC	4.3	5.5	V
Termination Input Voltage	VTT_IN	1.0	5.5	V
EN Input Voltage	VEN	-0.3	5.5	V

★ No radiation-resistant design is adopted for the present product.

●ELECTRICAL CHARACTERISTICS

◎BD3533F/FVM/EKN

ELECTRICAL CHARACTERISTICS(unless otherwise noted, Ta=25°C VCC=3.3V VEN=3V VDDQ=1.8V VTT\_IN=1.8V)

Parameter	Symbol	Standard Value			Unit	Condition
		MIN	TYP	MAX		
Standby Current	IST	-	0.8	1.6	mA	VEN=0V
Bias Current	ICC	-	2	4	mA	VEN=3V
[Enable]						
High Level Enable Input Voltage	VENHIGH	2.3	-	5.5	V	
Low Level Enable Input Voltage	VENLOW	-0.3	-	0.8	V	
Enable Pin Input Current	IEN	-	7	10	uA	VEN=3V
[Termination]						
Termination Output Voltage 1	VTT1	VREF -30m	VREF	VREF +30m	V	ITT=-1.0A to 1.0A Ta=0°C to 100°C *7
Termination Output Voltage 2	VTT2	VREF -30m	VREF	VREF +30m	V	VCC=5V, VDDQ=2.5V VTT_IN=2.5V ITT=-1.0A to 1.0A Ta=0°C to 100°C *7
Source Current	ITT+	1.0	-	-	A	
Sink Current	ITT-	-	-	-1.0	A	
Load Regulation	$\Delta$ VTT	-	-	50	mV	ITT=-1.0A to 1.0A
Line Regulation	Reg.l	-	20	40	mV	
Upper Side ON Resistance 1	HRON1	-	0.45	0.9	Ω	
Lower Side ON Resistance 1	LRON1	-	0.45	0.9	Ω	
Upper Side ON Resistance 2	HRON2	-	0.4	0.8	Ω	VCC=5V, VDDQ=2.5V VTT_IN=2.5V
Lower Side ON Resistance 2	LRON2	-	0.4	0.8	Ω	VCC=5V, VDDQ=2.5V VTT_IN=2.5V

\*7 Design Guarantee

●ELECTRICAL CHARACTERISTICS

◎BD3533F/FVM/EKN

ELECTRICAL CHARACTERISTICS(unless otherwise noted, Ta=25°C VCC=3.3V VEN=3V VDDQ=1.8V VTT\_IN=1.8V)

Parameter	Symbol	Standard Value			Unit	Condition
		MIN	TYP	MAX		
[Input of Reference Voltage]						
Input Impedance	ZVDDQ	70	100	130	kΩ	
Output Voltage1	VREF1	1/2 × VDDQ -18m	1/2 × VDDQ	1/2 × VDDQ +18m	V	IREF=-5mA to 5mA Ta=0°C to 100°C <sup>*7</sup>
Output Voltage2	VREF2	1/2 × VDDQ -40m	1/2 × VDDQ	1/2 × VDDQ +40m	V	IREF=-10mA to 10mA Ta=0°C to 100°C <sup>*7</sup>
Output Voltage3	VREF3	1/2 × VDDQ -25m	1/2 × VDDQ	1/2 × VDDQ +25m	V	VCC=5V, VDDQ=VTT_IN=2.5V IREF=-5mA to 5mA Ta=0°C to 100°C <sup>*7</sup>
Output Voltage4	VREF4	1/2 × VDDQ -40m	1/2 × VDDQ	1/2 × VDDQ +40m	V	VCC=5V, VDDQ=VTT_IN=2.5V IREF=-10mA to 10mA Ta=0°C to 100°C <sup>*7</sup>
[Reference voltage]						
Source Current	IREF+	20	-	-	mA	
Sink Current	IREF-	-	-	-20	mA	
[UVLO]						
UVLO OFF Voltage	VUVLO	2.40	2.55	2.70	V	VCC : sweep up
Hysteresis Voltage	ΔVUVLO	100	160	220	mV	VCC : sweep down

\*7 Design Guarantee

◎BD3531F

ELECTRICAL CHARACTERISTICS(unless otherwise noted, Ta=25°C VCC=5V VEN=3V VDDQ=2.5V VTT\_IN=2.5V)

Parameter	Symbol	Standard Value			Unit	Condition
		MIN	TYP	MAX		
Standby Current	IST	-	0.8	1.6	mA	VEN=0V
Bias Current	ICC	-	2	4	mA	
[Enable]						
Hi Level Enable Input Voltage	VENHI	2	-	5.5	V	
Low Level Enable Input Voltage	VENLOW	-0.3	-	0.8	V	
Enable Pin Input Current	IEN	-	7	10	uA	VEN=3V
[Termination]						
Termination Output Voltage	VTT	VREF -30mV	VREF	VREF +30mV	V	Io=-1.5A to 1.5A Ta=0°C to 100°C <sup>*8</sup>
Source Current	ITT+	1.5	-	-	A	
Sink Current	ITT-	-	-	-1.5	A	
Load Regulation	ΔVTT	-	-	40	mV	Io=-1.5A to 1.5A
Line Regulation	Reg.I	-	20	40	mV	VCC=4.5V to 5.5V
Upper Side ON Resistance	HRON	-	0.4	0.8	Ω	
Lower Side ON Resistance	LRON	-	0.4	0.8	Ω	
[Input of Reference Voltage]						
Input Impedance	ZVDDQ	-	100	-	kΩ	
[Reference voltage]						
Output Voltage1	VREF1	1/2 × VDDQ-30m	1/2 × VDDQ	1/2 × VDDQ+30m	V	IREF=0mA
Output Voltage2	VREF2	1/2 × VDDQ -40m	1/2 × VDDQ	1/2 × VDDQ +40m	V	IREF=-10mA to 10mA Ta=0°C to 100°C <sup>*8</sup>
Source Current	IREF+	10	20	-	mA	
Sink Current	IREF-	-	-20	-10	mA	
[UVLO]						
UVLO OFF Voltage	VUVLO	4.2	4.35	4.5	V	VCC : Sweep up
Hysteresis Voltage	ΔVUVLO	100	160	220	mV	VCC : Sweep down

\*8 Design Guarantee

Parameter	Symbol	Standard Value			Unit	Condition
		MIN	TYP	MAX		
Standby Current	IST	-	0.8	1.6	mA	VEN=0V
Bias Current	ICC	-	2	4	mA	
[Enable]						
Hi Level Enable Input Voltage	VENHI	2.3	-	5.5	V	VCC=4.3V to 5.5V Ta=0°C to 100°C *9
Low Level Enable Input Voltage	VENLOW	-0.3	-	0.8	V	VCC=4.3V to 5.5V Ta=0°C to 100°C *9
Enable Pin Input Current	IEN	-	7	10	uA	VEN=3V
[Termination]						
Termination Output Voltage	VTT	VREF -30mV	VREF	VREF +30mV	V	Io=-3A to 3A Ta=0°C to 100°C *9
Source Current	ITT+	3	-	-	A	
Sink Current	ITT-	-	-	-3	A	
Load Regulation	$\Delta$ VTT	-	-	40	mV	Io=-3A to 3A
Line Regulation	Reg.I	-	20	40	mV	VCC=4.3V to 5.5V
Upper Side ON Resistance	HRON	-	0.2	0.4	$\Omega$	
Lower Side ON Resistance	LRON	-	0.2	0.4	$\Omega$	
[Input of Reference Voltage]						
Input Impedance	ZVDDQ	70	100	130	k $\Omega$	
Output Voltage1	VREF1	1/2 × VDDQ -30mV	1/2 × VDDQ	1/2 × VDDQ +30mV	V	IREF=0mA
Output Voltage2	VREF2	1/2 × VDDQ -40mV	1/2 × VDDQ	1/2 × VDDQ +40mV	V	IREF=-10mA to 10mA Ta=0°C to 100°C *9
Output Voltage1'	VREF1'	1/2 × VDDQ -30mV	1/2 × VDDQ	1/2 × VDDQ +30mV	V	VDDQ=VTT_IN1=VTT_IN2=1.8V IREF=0mA
Output Voltage2'	VREF2'	1/2 × VDDQ -40mV	1/2 × VDDQ	1/2 × VDDQ +40mV	V	VDDQ=VTT_IN1=VTT_IN2=1.8V IREF=-10mA to 10mA Ta=0°C to 100°C *9
Source Current1	IREF1+	20	-	-	mA	
Sink Current1	IREF1-	-	-	-20	mA	
Source Current2	IREF2+	20	-	-	mA	VDDQ=VTT_IN1=VTT_IN2=1.8V
Sink Current2	IREF2-	-	-	-20	mA	VDDQ=VTT_IN1=VTT_IN2=1.8V
[UVLO]						
UVLO OFF Voltage	VUVLO	4.0	4.15	4.3	V	VCC : sweep up
Hysteresis Voltage	$\Delta$ VUVLO	100	160	220	mV	VCC : sweep down

\*9 Design Guarantee

●Reference Data

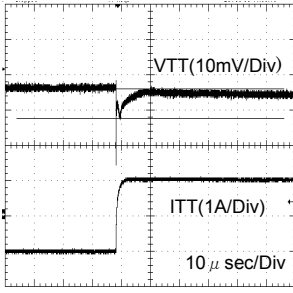

Fig.1 DDR I (-1A→1A) BD3531

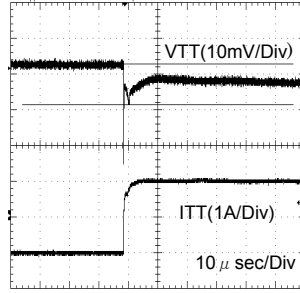

Fig.2 DDR I (-1A→1A) BD3532

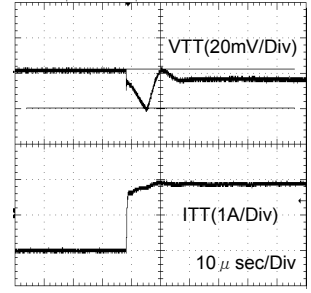

Fig.3 DDR I (-1A→1A) BD3533

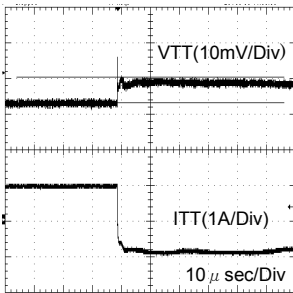

Fig.4 DDR I (1A→-1A) BD3531

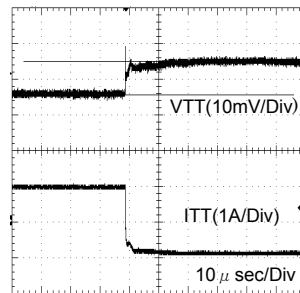

Fig.5 DDR I (1A→-1A) BD3532

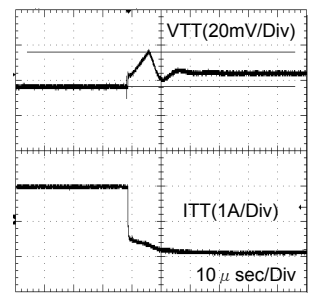

Fig.6 DDR I (1A→-1A) BD3533

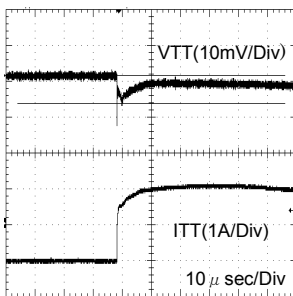

Fig.7 DDR II (-1A→1A) BD3531

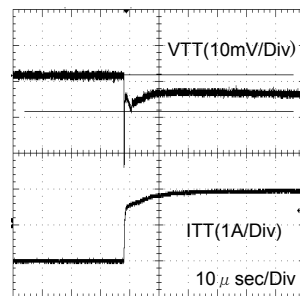

Fig.8 DDR II (-1A→1A) BD3532

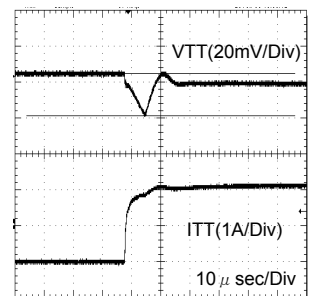

Fig.9 DDR II (-1A→1A) BD3533

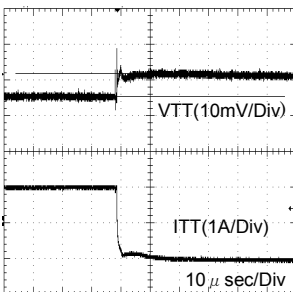

Fig.10 DDR II (1A→-1A) BD3531

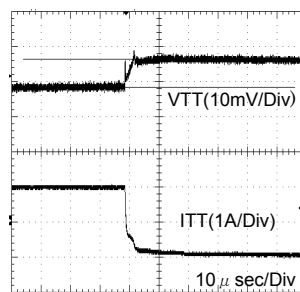

Fig.11 DDR II (1A→-1A) BD3532

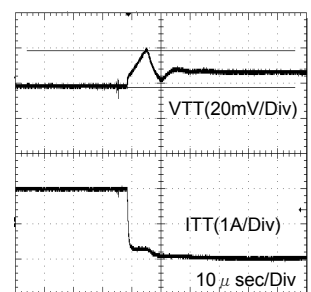

Fig.12 DDR II (1A→-1A) BD3533

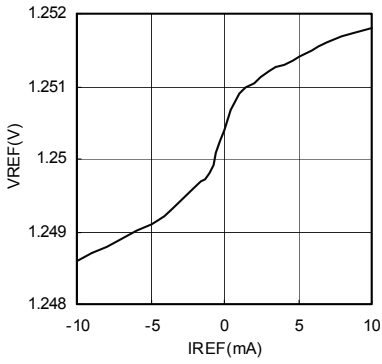

Fig.13 IREF-VREF (DDR- I )

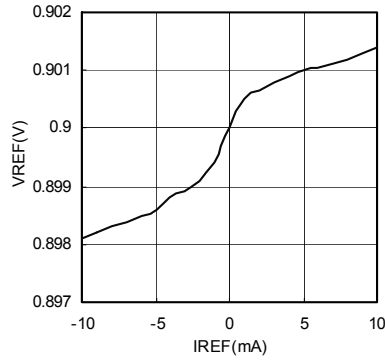

Fig.14 IREF-VREF (DDR- II )

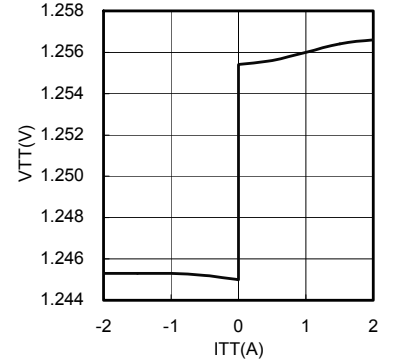

Fig.15 ITT-VTT (DDR- I )

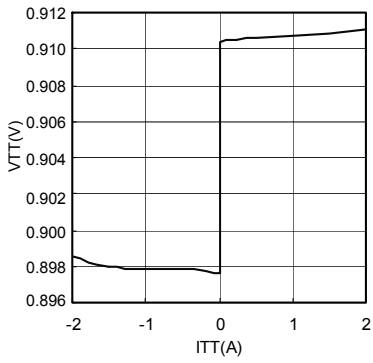

Fig.16 ITT-VTT (DDR- II )

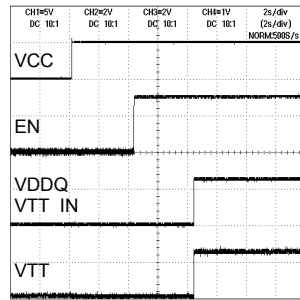

Fig.17 Input Sequence 1

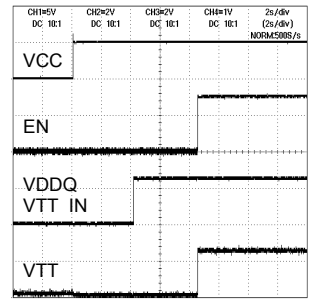

Fig.18 Input Sequence 2

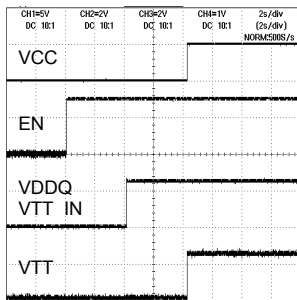

Fig.19 Input Sequence 3

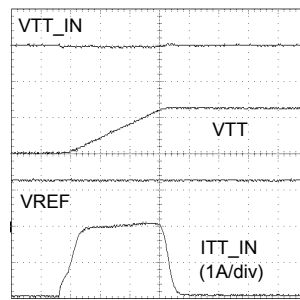
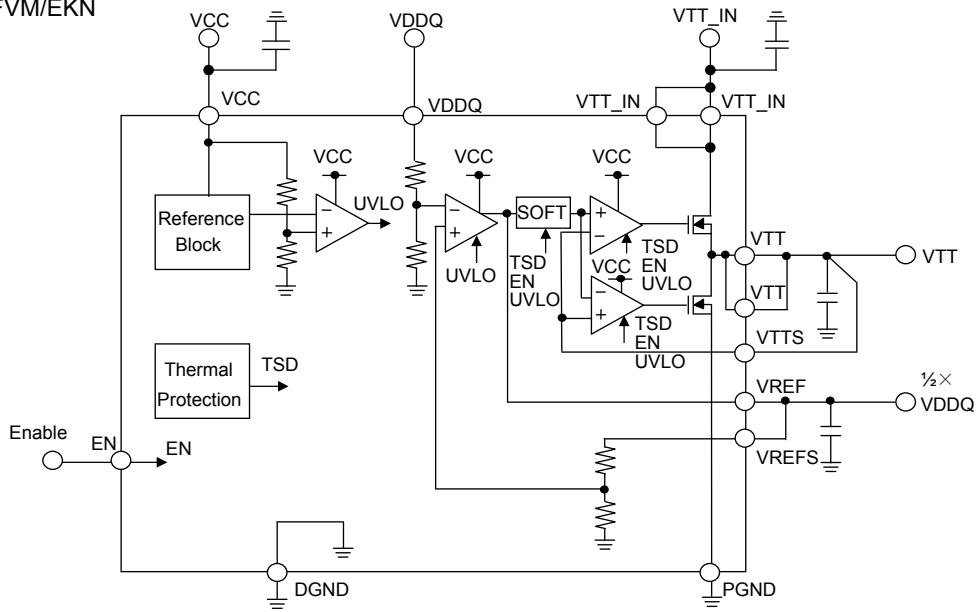

Fig.20 Start up Wave Form

●BLOCK DIAGRAM

©BD3533F/FVM/EKN



©BD3531F

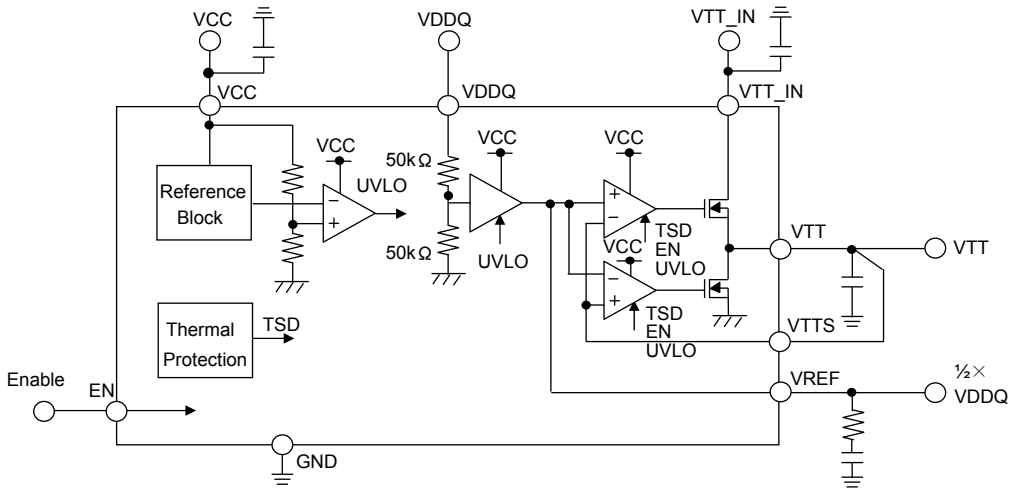

©BD3532F/FVM/EKN

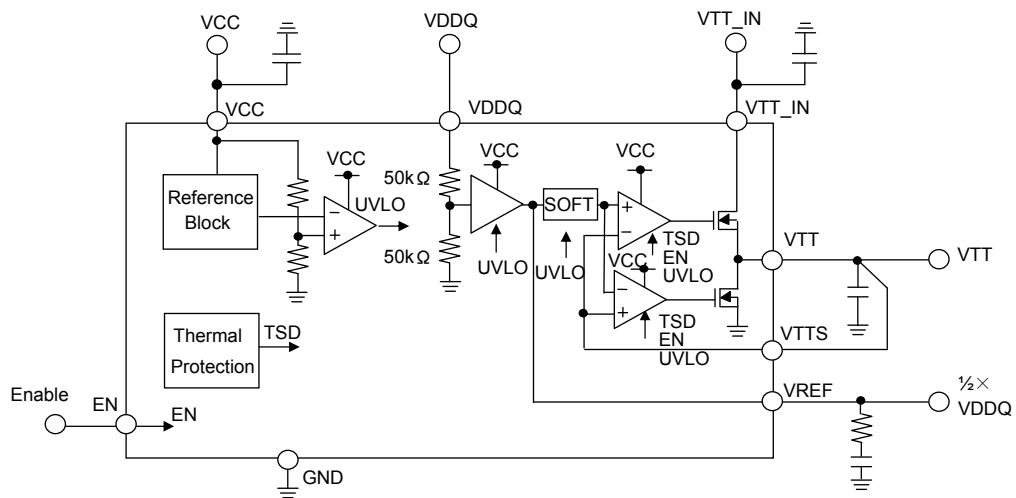



●PIN CONFIGURATION

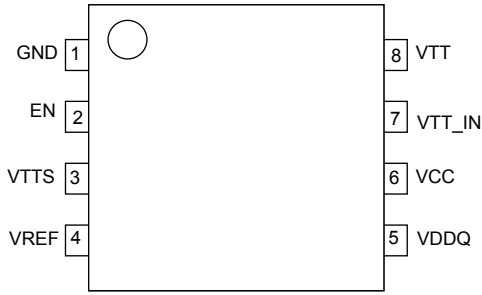

●PIN FUNCTION

PIN No.	PIN NAME	PIN FUNCTION
1	GND	GND Pin
2	EN	Enable Input Pin
3	VTTS	Detector Pin for Termination Voltage
4	VREF	Reference Voltage Output Pin
5	VDDQ	Reference Voltage Input Pin
6	VCC	VCC Pin
7	VTT_IN	Termination Input Pin
8	VTT	Termination Output Pin

●PIN CONFIGURATION

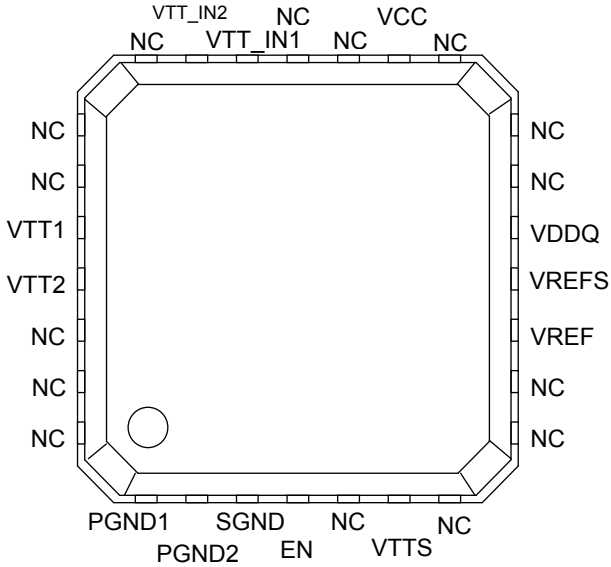

●PIN FUNCTION

PIN No.	PIN NAME	PIN FUNCTION
1	PGND1	Power Ground Pin 1
2	PGND2	Power Ground Pin 2
3	SGND	Ground Pin for Reference Voltage
4	EN	Enable Input Pin
5	N.C.	Non Connection
6	VTTS	Detector Pin for Termination Voltage
7	N.C.	Non Connection
8	N.C.	Non Connection
9	N.C.	Non Connection
10	VREF	Reference Voltage Output Pin
11	VREFS	Detector Pin for Reference Voltage
12	VDDQ	Reference Voltage Input Pin
13	N.C.	Non Connection
14	N.C.	Non Connection
15	N.C.	Non Connection
16	VCC	VCC Pin
17	N.C.	Non Connection
18	N.C.	Non Connection
19	VTT_IN1	Termination Input Pin 1
20	VTT_IN2	Termination Input Pin 2
21	N.C.	Non Connection
22	N.C.	Non Connection
23	N.C.	Non Connection
24	VTT1	Termination Output Pin 1
25	VTT2	Termination Output Pin 2
26	N.C.	Non Connection
27	N.C.	Non Connection
28	N.C.	Non Connection

●PIN CONFIGURATION

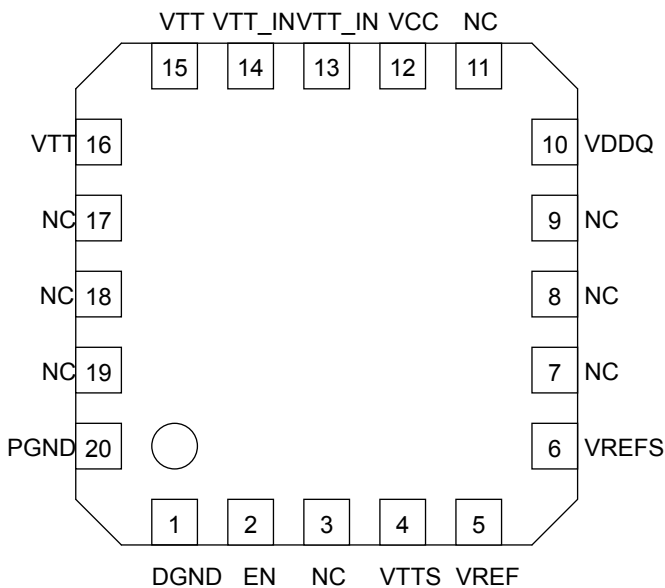

●PIN FUNCTION

PIN No.	PIN NAME	PIN FUNCTION
1	DGND	Digital Ground Pin
2	EN	Enable Input Pin
3	NC	Non Connection
4	VTTS	Detector Pin for Termination Voltage
5	VREF	Reference Voltage Output Pin
6	VREFS	Detector Pin for Reference Voltage
7	NC	Non Connection
8	NC	Non Connection
9	NC	Non Connection
10	VDDQ	Reference Voltage Input Pin
11	NC	Non Connection
12	VCC	VCC Pin
13	VTT_IN	Termination Input Pin
14	VTT_IN	Termination Input Pin
15	VTT	Termination Output Pin
16	VTT	Termination Output Pin
17	NC	Non Connection
18	NC	Non Connection
19	NC	Non Connection
20	PGND	Power Ground Pin

●PIN CONFIGURATION

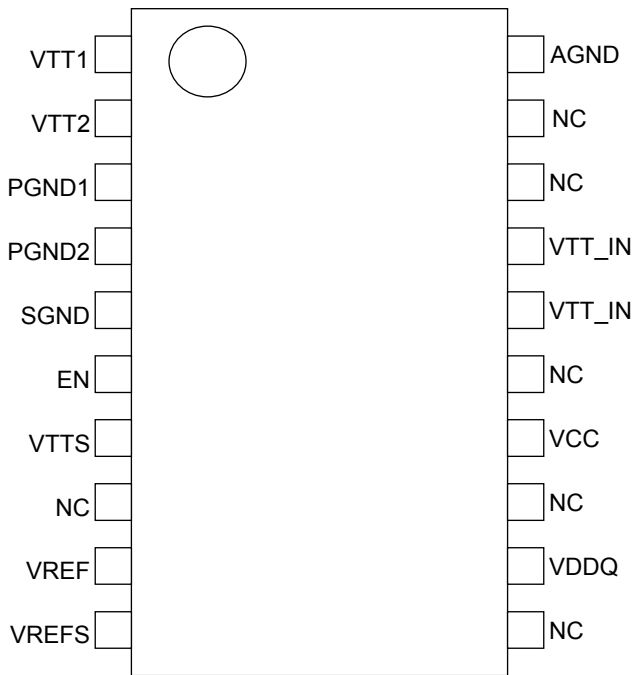

●PIN FUNCTION

PIN No.	PIN NAME	PIN FUNCTION
1	VTT1	Termination Output Pin 1
2	VTT2	Termination Output Pin 2
3	PGND1	Power Ground Pin 1
4	PGND2	Power Ground Pin 2
5	SGND	Ground Pin for Reference Voltage
6	EN	Enable Input Pin
7	VTTS	Detector Pin for Termination Voltage
8	N.C.	Non Connection
9	VREF	Reference Voltage Output Pin
10	VREFS	Detector Pin for Reference Voltage
11	N.C.	Non Connection
12	VDDQ	Reference Voltage Input Pin
13	N.C.	Non Connection
14	VCC	VCC Pin
15	N.C.	Non Connection
16	VTT_IN1	Termination Input Pin 1
17	VTT_IN2	Termination Input Pin 2
18	N.C.	Non Connection
19	N.C.	Non Connection
20	AGND	Ground Pin for Analog Ground
-	FIN	Substrate (Connected to AGND)

●Description of operations

• VCC

In BD3533/31/32, an independent power input pin is provided for an internal circuit operation of the IC. This is used to drive the amplifier circuit of the IC, and its maximum current rating is 4 mA. The power supply voltage is 3.3 to 5.5 volts (BD3533) or 5 volts (BD3531/32). It is recommended to connect a bypass capacitor of 1 μF or so to VCC.

• VDDQ

Reference input pin for the output voltage, that may be used to satisfy the JEDEC requirement for DDR-SDRAM (VTT = 1/2VDDQ) by dividing the voltage inside the IC with two 50 kΩ voltage-divider resistors

For BD3533, care must be taken to an input noise to VDDQ pin because this IC also cuts such noise input into half and provides it with the voltage output divided in half. Such noise may be reduced with an RC filter consisting of such resistance and capacitance (220 Ω and 2.2 μF, for instance) that may not give significant effect to voltage dividing inside the IC.

• VTT\_IN

VTT\_IN is a power supply input pin for VTT output. Voltage in the range between 1.0 and 5.5 volts may be supplied to this VTT\_IN terminal, but care must be taken to the current limitation due to on-resistance of the IC and the change in allowable loss due to input/output voltage difference.

Generally, the following voltages are supplied:

- DDR I VTT\_IN=2.5V
- DDR II VTT\_IN=1.8V

Higher impedance of the voltage input at VTT\_IN may result in oscillation or degradation in ripple rejection, which must be noted. To VTT\_IN terminal, it is recommended to use a 10 μF capacitor characterized with less change in capacitance. But it may depend on the characteristics of the power supply input and the impedance of the pc board wiring, which must be carefully checked before use.

• VREF

In BD3533/31/32, a reference voltage output pin independent from VTT output is given to provide a reference input for a memory controller and a DRAM. Even if EN pin turns to “Low” level, VREF output is kept unchanged, compatible with “Self Refresh” state of DRAM. The maximum current capability of VREF is 20 mA, and a suitable capacitor is needed to stabilize the output voltage. It is recommended to use a combination of a 1.0 to 2.2 μF ceramic capacitor characterized with less change in capacitance and a 0.5 to 2.2 Ω phase compensator resistor, or a 10μF ceramic or tantalum capacitor instead. For an application where VREF current is low, a capacitor of lower capacitance may be used. If VREF current is 1 mA or less, it is possible to secure a phase margin with a ceramic capacitor of 1 μF more or less.

• VTTS

An independent pin provided to improve load regulation of VTT output. In case that longer wiring is needed to the load at VTT output, connecting VTTS from the load side may improve the load regulation.

• VTT

A DDR memory termination output pin. BD3533/31/32 has a sink/source current capability of  $\pm 1.0A/\pm 1.5A/\pm 3.0A$  respectively. The output voltage tracks the voltage divided in half at VDDQ pin. VTT output is turned to OFF when VCC UVLO or thermal shutdown protector is activated with EN pin level turned to "Low". Do not fail to connect a capacitor to VTT output pin for a loop gain phase compensation and a reduction in output voltage variation in the event of sudden change in load. Insufficient capacitance may cause an oscillation. High ESR (Equivalent Series Resistance) of the capacitor may result in increase in output voltage variation in the event of sudden change in load. It is recommended to use a 220  $\mu F$  functional polymer capacitor (OS-CON, POS-CAP, NEO-CAP), though it depends on ambient temperature and other conditions. A low ESR ceramic capacitor may reduce a loop gain phase margin and may cause an oscillation, which may be improved by connecting a resistor in series with the capacitor.

• EN

With an input of 2.3 volts or higher, the level at EN pin turns to "High" to provide VTT output. If the input is lowered to 0.8 volts or less, the level at EN pin turns to "Low" and VTT status turns to Hi-Z. But if VCC and VDDQ are established, VREF output is maintained.

● Evaluation Board

■ BD3533F Evaluation Board Circuit

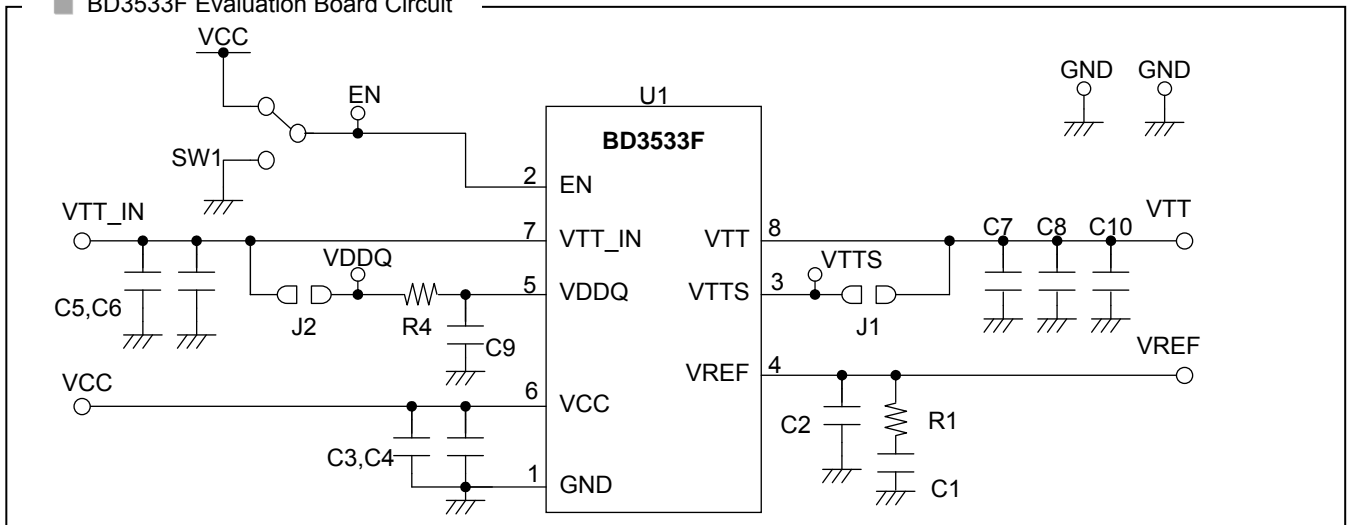

■ BD3533F Evaluation Board Application Components

Part No	Value	Company	Parts Name
U1	-	ROHM	BD3533F
R1	-	-	-
R4	220 $\Omega$	ROHM	MCR032200
J1	0 $\Omega$	-	-
J2	0 $\Omega$	-	-
C1	-	-	-
C2	10 $\mu F$	KYOCERA	CM21B106M06A
C3	1 $\mu F$	KYOCERA	CM105B105K06A

Part No	Value	Company	Parts Name
C4	-	-	-
C5	10 $\mu F$	KYOCERA	CM21B106M06A
C6	-	-	-
C7	-	-	-
C8	-	-	-
C9	2.2 $\mu F$	KYOCERA	CM105B225K06A
C10	220 $\mu F$	SANYO	2R5TPE220MF

■ BD3533F (SOP8) Evaluation Board Layout

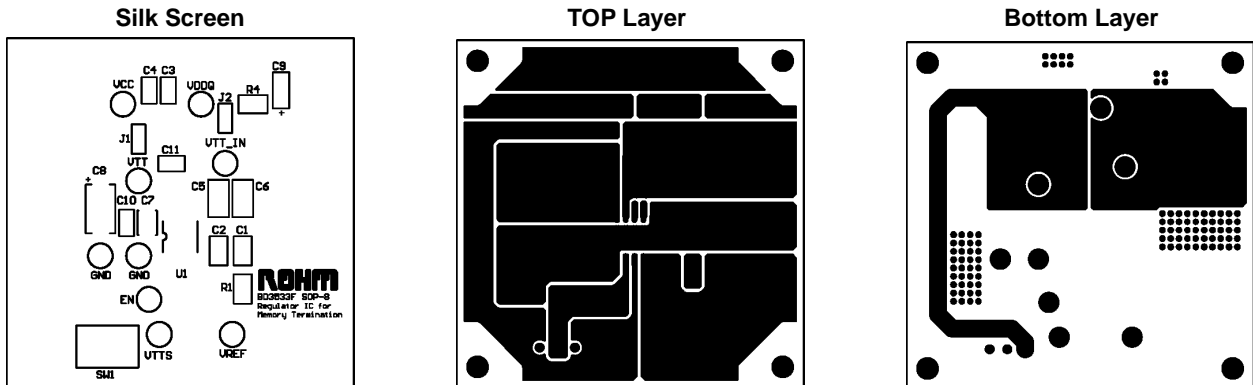

Versions for MSOP8 and HQFN20V packages are also available. In addition, BD3533F/FVM/EKN(1A), BD3531F(1.5A), and BD3532F/EFV/KN(3A) are available.

● Heat loss

Thermal design must be conducted with the operation under the conditions listed below (which are the guaranteed temperature range requiring consideration on appropriate margins etc.):

1. Ambient temperature Ta: 100°C or lower
2. Chip junction temperature Tj: 150°C or lower

The chip junction temperature Tj can be considered as follows. See Page 14/16 for  $\theta_{ja}$ .

Most of heat loss in BD3533/31/32 occurs at the output N-channel FET. The power lost is determined by multiplying the voltage between VIN and Vo by the output current. As this IC employs the power PKG, the thermal derating characteristics significantly depends on the pc board conditions. When designing, care must be taken to the size of a pc board to be used.

$$\text{Power dissipation (W)} = \{\text{Input voltage (V}_{TT\_IN}) - \text{Output voltage (V}_{TT=1/2VDDQ})\} \times I_o \text{ (Ave)}$$

If VTT\_IN = 1.8 volts, VDDQ=1.8 volts, and Io (Ave)=0.5 A, for instance, the power dissipation is determined as follows:  
 Power dissipation (W) = {1.8 (V) – 0.9 (V)} × 0.5 (A) = 0.4 (W)

● NOTE FOR USE

1. Absolute maximum ratings

For the present product, thoroughgoing quality control is carried out, but in the event that applied voltage, working temperature range, and other absolute maximum rating are exceeded, the present product may be destroyed. Because it is unable to identify the short mode, open mode, etc., if any special mode is assumed, which exceeds the absolute maximum rating, physical safety measures are requested to be taken, such as fuses, etc.

2. GND potential

Bring the GND terminal potential to the minimum potential in any operating condition.

3. Thermal design

Consider allowable loss (Pd) under actual working condition and carry out thermal design with sufficient margin provided.

4. Terminal-to-terminal short-circuit and erroneous mounting

When the present IC is mounted to a printed circuit board, take utmost care to direction of IC and displacement. In the event that the IC is mounted erroneously, IC may be destroyed. In the event of short-circuit caused by foreign matter that enters in a clearance between outputs or output and power-GND, the IC may be destroyed.

5. Operation in strong electromagnetic field

The use of the present IC in the strong electromagnetic field may result in maloperation, to which care must be taken.

6. Built-in thermal shutdown protection circuit

The present IC incorporates a thermal shutdown protection circuit (TSD circuit). The working temperature is 175°C (standard value) and has a -15°C (standard value) hysteresis width. When the IC chip temperature rises and the TSD circuit operates, the output terminal is brought to the OFF state. The built-in thermal shutdown protection circuit (TSD circuit) is first and foremost intended for interrupt IC from thermal runaway, and is not intended to protect and warrant the IC.

Consequently, never attempt to continuously use the IC after this circuit is activated or to use the circuit with the activation of the circuit premised.

7. Capacitor across output and GND

In the event a large capacitor is connected across output and GND, when Vcc and VIN are short-circuited with 0V or GND for some kind of reasons, current charged in the capacitor flows into the output and may destroy the IC. Use a capacitor smaller than 1000  $\mu$ F between output and GND.

8. Inspection by set substrate

In the event a capacitor is connected to a pin with low impedance at the time of inspection with a set substrate, there is a fear of applying stress to the IC. Therefore, be sure to discharge electricity for every process. As electrostatic measures, provide grounding in the assembly process, and take utmost care in transportation and storage. Furthermore, when the set substrate is connected to a jig in the inspection process, be sure to turn OFF power supply to connect the jig and be sure to turn OFF power supply to remove the jig.

9. Inputs to IC terminals

This device is a monolithic IC with P<sup>+</sup> isolation between P-substrate and each element as illustrated below. This P-layer and the N-layer of each element form a PN junction which works as:

- a diode if the electric potentials at the terminals satisfy the following relationship; GND>Terminal A>Terminal B, or
- a parasitic transistor if the electric potentials at the terminals satisfy the following relationship; Terminal B>GND Terminal A.

The structure of the IC inevitably forms parasitic elements, the activation of which may cause interference among circuits, and/or malfunctions contributing to breakdown. It is therefore requested to take care not to use the device in such manner that the voltage lower than GND (at P-substrate) may be applied to the input terminal, which may result in activation of parasitic elements.

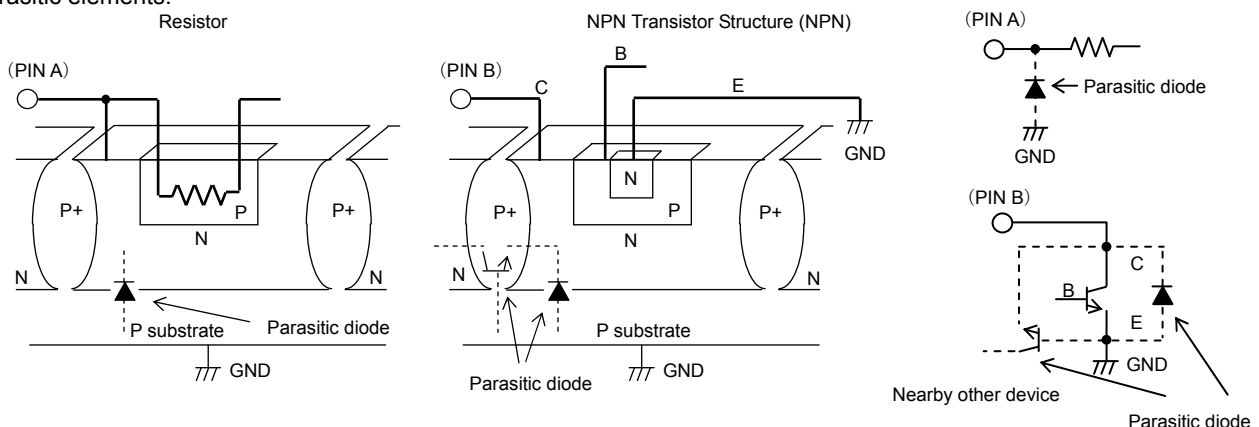

10. GND wiring pattern

When both a small-signal GND and high current GND are present, single-point grounding (at the set standard point) is recommended, in order to separate the small-signal and high current patterns, and to be sure the voltage change stemming from the wiring resistance and high current does not cause any voltage change in the small-signal GND. In the same way, care must be taken to avoid wiring pattern fluctuations in any connected external component GND.

11. Output capacitor (C1)

Do not fail to connect a output capacitor to VREF output terminal for stabilization of output voltage. The capacitor connected to VREF output terminal works as a loop gain phase compensator. Insufficient capacitance may cause an oscillation. It is recommended to use a low temperature coefficient 1-10 μF ceramic capacitor, though it depends on ambient temperature and load conditions. It is therefore requested to carefully check under the actual temperature and load conditions to be applied.

12. Output capacitor (C4)

Do not fail to connect a capacitor to VTT output pin for stabilization of output voltage. This output capacitor works as a loop gain phase compensator and an output voltage variation reducer in the event of sudden change in load. Insufficient capacitance may cause an oscillation. And if the equivalent series resistance (ESR) of this capacitor is high, the variation in output voltage increases in the event of sudden change in load. It is recommended to use a 47-220 μF functional polymer capacitor, though it depends on ambient temperature and load conditions. Using a low ESR ceramic capacitor may reduce a loop gain phase margin and cause an oscillation, which may be improved by connecting a resistor in series with the capacitor. It is therefore requested to carefully check under the actual temperature and load conditions to be applied.

13. Input capacitors (C2 and C3)

These input capacitors are used to reduce the output impedance of power supply to be connected to the input terminals (VCC and VTT\_IN). Increase in the power supply output impedance may result in oscillation or degradation in ripple rejecting characteristics. It is recommended to use a low temperature coefficient 1μF (for VCC) and 10μF (for VTT\_IN) capacitor, but it depends on the characteristics of the power supply input, and the capacitance and impedance of the pc board wiring pattern. It is therefore requested to carefully check under the actual temperature and load conditions to be applied.

14. Input terminals (VCC, VDDQ, VTT\_IN and EN)

VCC, VDDQ, VTT\_IN and EN terminals of this IC are made up independent one another. To VCC terminal, the UVLO function is provided for malfunction protection. Irrespective of the input order of the inputs terminals, VTT output is activated to provide the output voltage when UVLO and EN voltages reach the threshold voltage while VREF output is activated when UVLO voltage reaches the threshold. If VDDQ and VTT\_IN terminals have equal potential and common impedance, any change in current at VTT\_IN terminal may result in variation of VTT\_IN voltage, which affects VDDQ terminal and may cause variation in the output voltage. It is therefore required to perform wiring in such manner that VDDQ and VTT\_IN terminals may not have common impedance. If impossible, take appropriate corrective measures including suitable CR filter to be inserted between VDDQ and VTT\_IN terminals.

15. VTT terminal

A terminal used to improve load regulation of VTT output. Connection with VTT terminal must be done not to have common impedance with high current line, which may offer better load regulation of VTT output.

16. Operating range

Within the operating range, the operation and function of the circuits are generally guaranteed at an ambient temperature within the range specified. The values specified for electrical characteristics may not be guaranteed, but drastic change may not occur to such characteristics within the operating range.

17. Allowable loss Pd

For the allowable loss, the thermal derating characteristics are shown in the Exhibit, which should be used as a guide. Any uses that exceed the allowable loss may result in degradation in the functions inherent to IC including a decrease in current capability due to chip temperature increase. Use within the allowable loss.

18. Built-in thermal shutdown protection circuit

Thermal shutdown protection circuit is built-in to prevent thermal breakdown. Turns VTT output to OFF when the thermal shutdown protection circuit activates. This thermal shutdown protection circuit is originally intended to protect the IC itself. It is therefore requested to conduct a thermal design not to exceed the temperature under which the thermal shutdown protection circuit can work.

19. The use in the strong electromagnetic field may sometimes cause malfunction, to which care must be taken.

In the event that load containing a large inductance component is connected to the output terminal, and generation of back-EMF at the start-up and when output is turned OFF is assumed, it is requested to insert a protection diode.

20. In the event that load containing a large inductance component is connected to the output terminal, and generation of back-EMF at the start-up and when output is turned OFF is assumed, it is requested to insert a protection diode.

(Example)

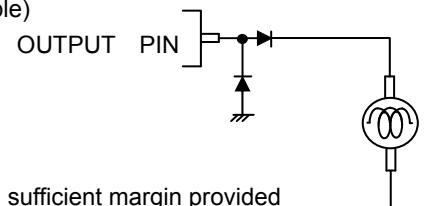

21. We are certain that examples of applied circuit diagrams are recommendable,

but you are requested to thoroughly confirm the characteristics before using the IC.

In addition, when the IC is used with the external circuit changed, decide the IC with sufficient margin provided while consideration is being given not only to static characteristics but also variations of external parts and our IC including transient characteristics.

●POWER DISSIPATION

◎SOP8(BD3533F/31F/32F)

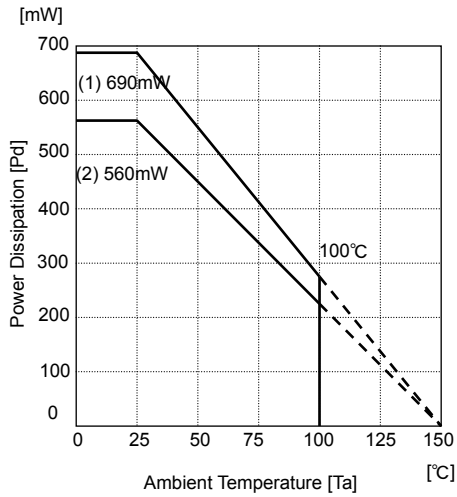

- (1) 70mm×70mm×1.6mm Glass-epoxy PCB  
 $\theta_{j-c}=181^{\circ}\text{C/W}$
- (2) With no heat sink  
 $\theta_{j-a}=222^{\circ}\text{C/W}$

◎MSOP8(BD3533FVM)

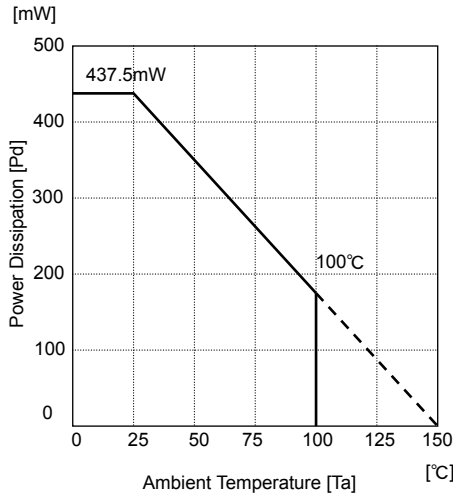

- With no heat sink  
 $\theta_{j-a}=286^{\circ}\text{C/W}$

◎HQFN20V(BD3533EKN)

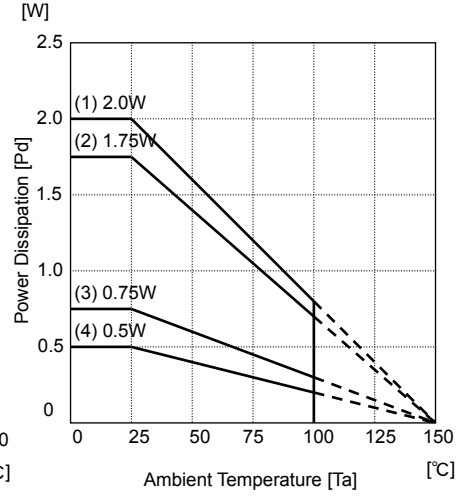

- (1) With no heat sink  
 $\theta_{j-a}=250^{\circ}\text{C/W}$
- (2) PCB (substrate surface copper foil area : None)  
 $\theta_{j-a}=166.7^{\circ}\text{C/W}$
- (3) PCB Single-layer substrate  
(substrate surface copper foil area : 15mm×15mm)  
 $\theta_{j-a}=71.4^{\circ}\text{C/W}$
- (4) PCB Double-layer substrate  
(substrate surface copper foil area : 60mm×60mm)  
 $\theta_{j-a}=62.5^{\circ}\text{C/W}$

◎HTSSOP-B20(BD3532EFV)

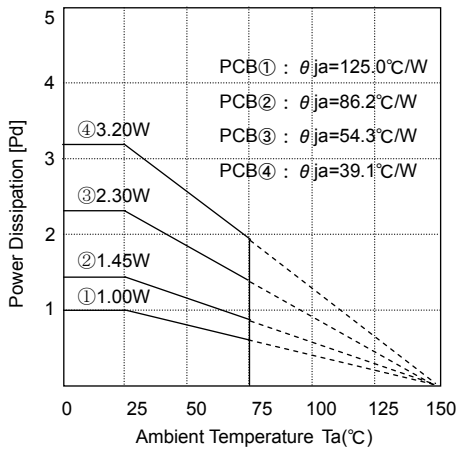

- PCB① :  $\theta_{j-a}=125.0^{\circ}\text{C/W}$
  - PCB② :  $\theta_{j-a}=86.2^{\circ}\text{C/W}$
  - PCB③ :  $\theta_{j-a}=54.3^{\circ}\text{C/W}$
  - PCB④ :  $\theta_{j-a}=39.1^{\circ}\text{C/W}$
- measure : TH-156 (Kuwano Denki)  
measure condition : Rohm Standard Board  
PCB size : 70mm×70mm×1.6mm  
(Thermal via in the board) Connect the board with the exposed area at the bottom surface of the package by soldering.
- PCB① : Single-layer substrate
  - PCB② : Double-layer substrate (substrate surface copper foil area : 15mm×15mm)
  - PCB③ : Double-layer substrate (substrate surface copper foil area : 70mm×70mm)

◎VQFN28(BD3532KN)

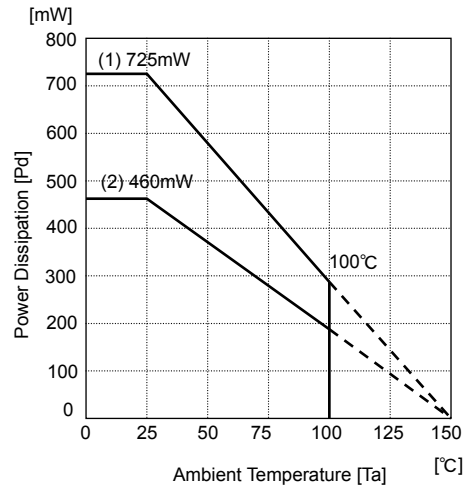

- (2) 70mm×70mm×1.6mm Glass-epoxy PCB  
 $\theta_{j-c}=172^{\circ}\text{C/W}$
- (2) With no heat sink  
 $\theta_{j-a}=270^{\circ}\text{C/W}$

● Ordering part number

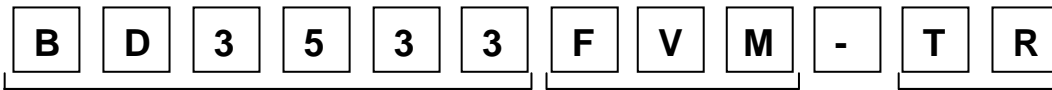

Part Number  
 • BD3533  
 • BD3531  
 • BD3532

Package Type  
 • F : SOP8  
 • FVM : MSOP8  
 • HFV : HTSSOP-B20  
 • KN : VQFN28  
 • EKN : HQFN20V

TR Emboss tape reel opposite draw-out side: 1 pin  
 E2 Emboss tape reel opposite draw-out side: 1 pin

**SOP8**

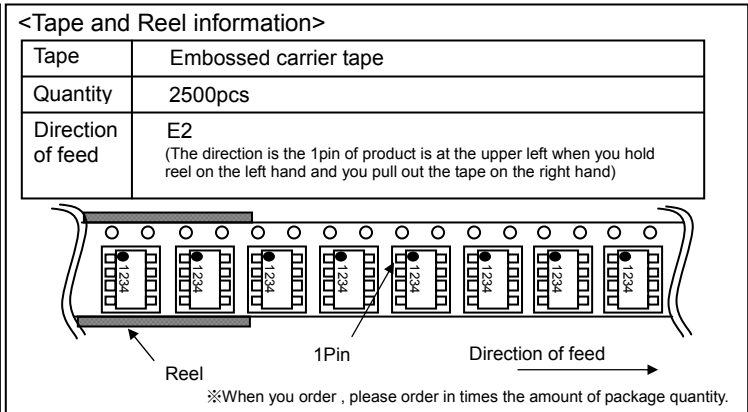
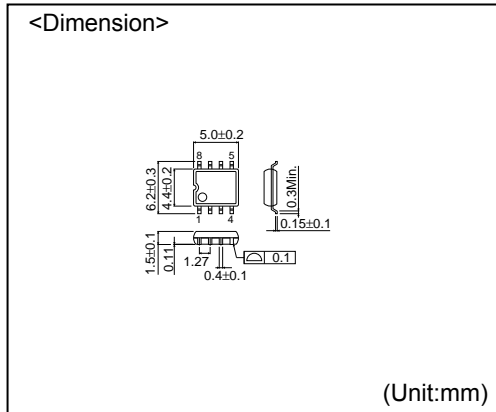

**MSOP8**

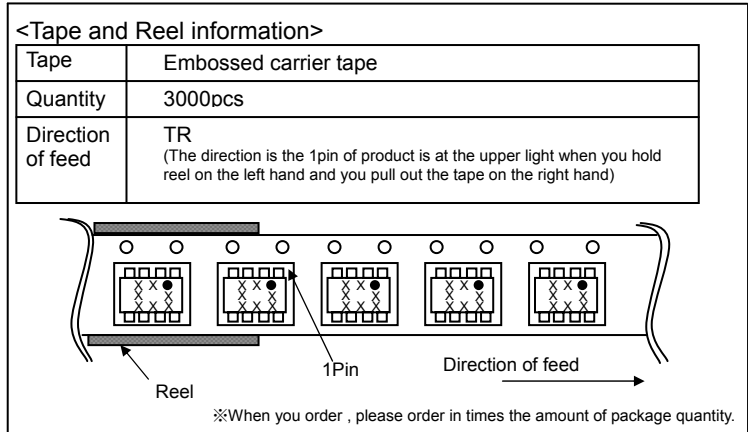
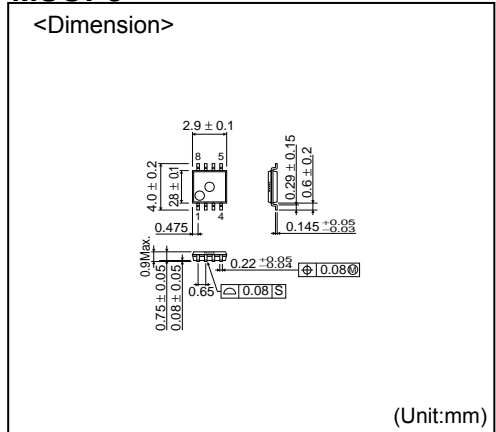

**HTSSOP-B20**

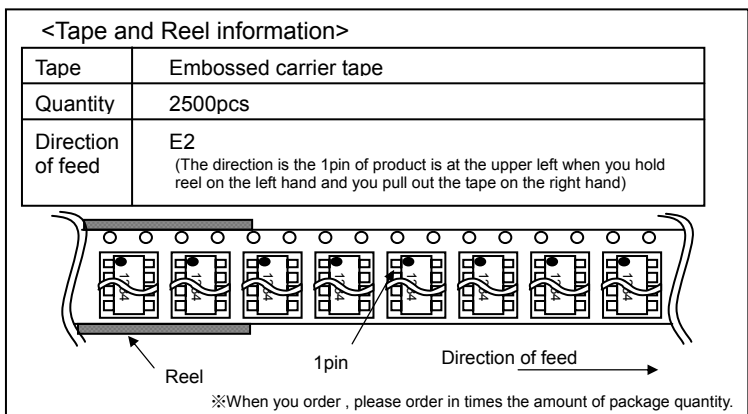
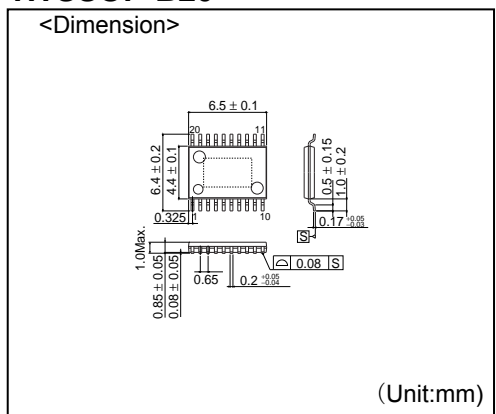

## VQFN28

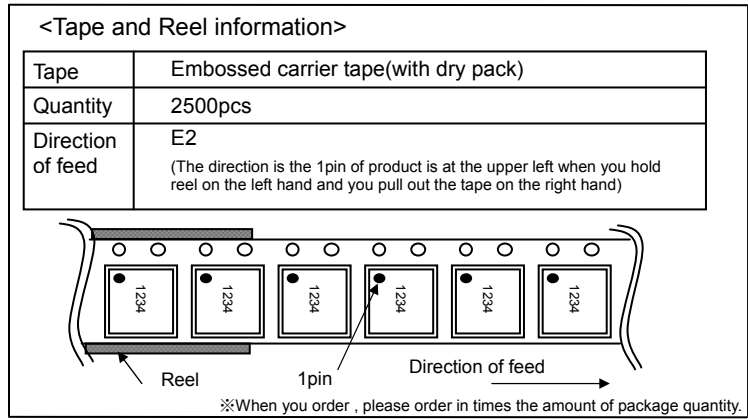
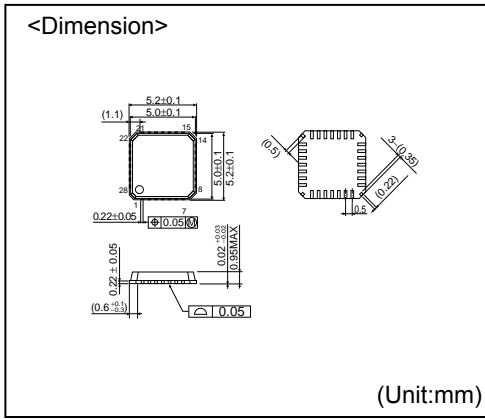

## HQFN20V

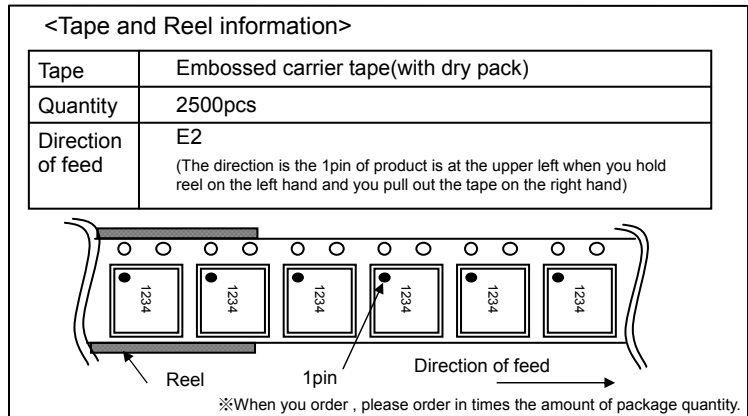
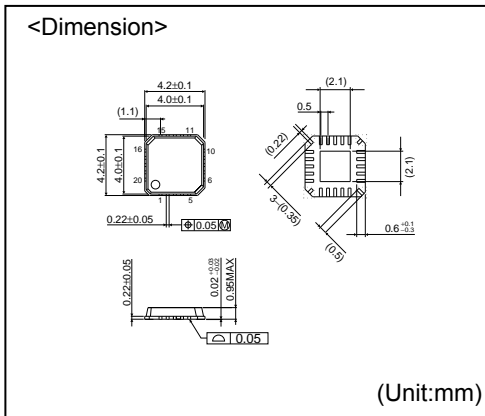

- The contents described herein are correct as of October, 2008
- The contents described herein are subject to change without notice. For updates of the latest information, please contact and confirm with ROHM CO.,LTD.
- Any part of this application note must not be duplicated or copied without our permission.
- Application circuit diagrams and circuit constants contained herein are shown as examples of standard use and operation. Please pay careful attention to the peripheral conditions when designing circuits and deciding upon circuit constants in the set.
- Any data, including, but not limited to application circuit diagrams and information, described herein are intended only as illustrations of such devices and not as the specifications for such devices. ROHM CO.,LTD. disclaims any warranty that any use of such devices shall be free from infringement of any third party's intellectual property rights or other proprietary rights, and further, assumes no liability of whatsoever nature in the event of any such infringement, or arising from or connected with or related to the use of such devices.
- Upon the sale of any such devices, other than for buyer's right to use such devices itself, resell or otherwise dispose of the same, implied right or license to practice or commercially exploit any intellectual property rights or other proprietary rights owned or controlled by ROHM CO., LTD. is granted to any such buyer.
- The products described herein utilize silicon as the main material.
- The products described herein are not designed to be X ray proof.

The products listed in this catalog are designed to be used with ordinary electronic equipment or devices (such as audio visual equipment, office-automation equipment, communications devices, electrical appliances and electronic toys). Should you intend to use these products with equipment or devices which require an extremely high level of reliability and the malfunction of which would directly endanger human life (such as medical instruments, transportation equipment, aerospace machinery, nuclear-reactor controllers, fuel controllers and other safety devices), please be sure to consult with our sales representative in advance.

Contact us for further information about the products.

<b>San Diego</b>	TEL: +1-858-625-3630	FAX: +1-858-625-3670	<b>Tianjin</b>	TEL: +86-22-23029181	FAX: +86-22-23029183
<b>Atlanta</b>	TEL: +1-770-754-5972	FAX: +1-770-754-0691	<b>Shanghai</b>	TEL: +86-21-6279-2727	FAX: +86-21-6247-2066
<b>Boston</b>	TEL: +1-978-371-0382	FAX: +1-928-438-7164	<b>Hangzhou</b>	TEL: +86-571-87658072	FAX: +86-571-87658071
<b>Chicago</b>	TEL: +1-847-368-1006	FAX: +1-847-368-1008	<b>Nanjing</b>	TEL: +86-25-8689-0015	FAX: +86-25-8689-0393
<b>Dallas</b>	TEL: +1-469-287-5366	FAX: +1-469-362-7973	<b>Ningbo</b>	TEL: +86-574-87654201	FAX: +86-574-87654208
<b>Denver</b>	TEL: +1-303-708-0908	FAX: +1-303-708-0858	<b>Qingdao</b>	TEL: +86-532-5779-312	FAX: +86-532-5779-653
<b>Detroit</b>	TEL: +1-248-348-9920	FAX: +1-248-348-9942	<b>Suzhou</b>	TEL: +86-512-6807-1300	FAX: +86-512-6807-2300
<b>Nashville</b>	TEL: +1-615-620-6700	FAX: +1-615-620-6702	<b>Wuxi</b>	TEL: +86-510-82702693	FAX: +86-510-82702992
<b>Mexico</b>	TEL: +52-33-3123-2001	FAX: +52-33-3123-2002	<b>Shenzhen</b>	TEL: +86-755-8307-3008	FAX: +86-755-8307-3003
<b>Düsseldorf</b>	TEL: +49-2154-9210	FAX: +49-2154-921400	<b>Dongguan</b>	TEL: +86-769-8393-3320	FAX: +86-769-8398-4140
<b>Munich</b>	TEL: +49-8999-216168	FAX: +49-8999-216176	<b>Fuzhou</b>	TEL: +86-591-8801-8698	FAX: +86-591-8801-8690
<b>Stuttgart</b>	TEL: +49-711-7272-370	FAX: +49-711-7272-3720	<b>Guangzhou</b>	TEL: +86-20-3878-8100	FAX: +86-20-3825-5965
<b>France</b>	TEL: +33-1-5697-3060	FAX: +33-1-5697-3080	<b>Huizhou</b>	TEL: +86-752-205-1054	FAX: +86-752-205-1059
<b>United Kingdom</b>	TEL: +44-1-908-306700	FAX: +44-1-908-235788	<b>Xiamen</b>	TEL: +86-592-238-5705	FAX: +86-592-239-8380
<b>Denmark</b>	TEL: +45-3694-4739	FAX: +45-3694-4789	<b>Zhuhai</b>	TEL: +86-756-3232-480	FAX: +86-756-3232-460
<b>Espoo</b>	TEL: +358-9725-54491	FAX: +358-9-7255-4499	<b>Hong Kong</b>	TEL: +852-2-740-6262	FAX: +852-2-375-8971
<b>Salo</b>	TEL: +358-2-7332234	FAX: +358-2-7332237	<b>Taipei</b>	TEL: +886-2-2500-6956	FAX: +886-2-2503-2869
<b>Oulu</b>	TEL: +358-8-5372930	FAX: +358-8-5372931	<b>Kaohsiung</b>	TEL: +886-7-237-0881	FAX: +886-7-238-7332
<b>Barcelona</b>	TEL: +34-9375-24320	FAX: +34-9375-24410	<b>Singapore</b>	TEL: +65-6332-2322	FAX: +65-6332-5662
<b>Hungary</b>	TEL: +36-1-4719338	FAX: +36-1-4719339	<b>Philippines</b>	TEL: +63-2-807-6872	FAX: +63-2-809-1422
<b>Poland</b>	TEL: +48-22-5757213	FAX: +48-22-5757001	<b>Thailand</b>	TEL: +66-2-254-4890	FAX: +66-2-256-6334
<b>Russia</b>	TEL: +7-495-739-41-74	FAX: +7-495-739-41-74	<b>Kuala Lumpur</b>	TEL: +60-3-7958-8355	FAX: +60-3-7958-8377
<b>Seoul</b>	TEL: +82-2-8182-700	FAX: +82-2-8182-715	<b>Penang</b>	TEL: +60-4-2286453	FAX: +60-4-2286452
<b>Masan</b>	TEL: +82-55-240-6234	FAX: +82-55-240-6236	<b>Kyoto</b>	TEL: +81-75-365-1218	FAX: +81-75-365-1228
<b>Dalian</b>	TEL: +86-411-8230-8549	FAX: +86-411-8230-8537	<b>Yokohama</b>	TEL: +81-45-476-2290	FAX: +81-45-476-2295
<b>Beijing</b>	TEL: +86-10-8525-2483	FAX: +86-10-8525-2489			

Excellence in Electronics

# ROHM

## ROHM CO., LTD.

21 Saiin Mizosaki-cho, Ukyo-ku, Kyoto  
615-8585, Japan  
TEL: +81-75-311-2121 FAX: +81-75-315-0172  
URL: <http://www.rohm.com>

Published by  
KTC LSI Development Headquarters  
LSI Business Promotion Group



### Notes

No copying or reproduction of this document, in part or in whole, is permitted without the consent of ROHM CO.,LTD.

The content specified herein is subject to change for improvement without notice.

The content specified herein is for the purpose of introducing ROHM's products (hereinafter "Products"). If you wish to use any such Product, please be sure to refer to the specifications, which can be obtained from ROHM upon request.

Examples of application circuits, circuit constants and any other information contained herein illustrate the standard usage and operations of the Products. The peripheral conditions must be taken into account when designing circuits for mass production.

Great care was taken in ensuring the accuracy of the information specified in this document. However, should you incur any damage arising from any inaccuracy or misprint of such information, ROHM shall bear no responsibility for such damage.

The technical information specified herein is intended only to show the typical functions of and examples of application circuits for the Products. ROHM does not grant you, explicitly or implicitly, any license to use or exercise intellectual property or other rights held by ROHM and other parties. ROHM shall bear no responsibility whatsoever for any dispute arising from the use of such technical information.

The Products specified in this document are intended to be used with general-use electronic equipment or devices (such as audio visual equipment, office-automation equipment, communication devices, electronic appliances and amusement devices).

The Products are not designed to be radiation tolerant.

While ROHM always makes efforts to enhance the quality and reliability of its Products, a Product may fail or malfunction for a variety of reasons.

Please be sure to implement in your equipment using the Products safety measures to guard against the possibility of physical injury, fire or any other damage caused in the event of the failure of any Product, such as derating, redundancy, fire control and fail-safe designs. ROHM shall bear no responsibility whatsoever for your use of any Product outside of the prescribed scope or not in accordance with the instruction manual.

The Products are not designed or manufactured to be used with any equipment, device or system which requires an extremely high level of reliability the failure or malfunction of which may result in a direct threat to human life or create a risk of human injury (such as a medical instrument, transportation equipment, aerospace machinery, nuclear-reactor controller, fuel-controller or other safety device). ROHM shall bear no responsibility in any way for use of any of the Products for the above special purposes. If a Product is intended to be used for any such special purpose, please contact a ROHM sales representative before purchasing.

If you intend to export or ship overseas any Product or technology specified herein that may be controlled under the Foreign Exchange and the Foreign Trade Law, you will be required to obtain a license or permit under the Law.

Thank you for your accessing to ROHM product informations.

More detail product informations and catalogs are available, please contact your nearest sales office.

**ROHM** Customer Support System

THE AMERICAS / EUROPE / ASIA / JAPAN

[www.rohm.com](http://www.rohm.com)

Contact us : [webmaster@rohm.co.jp](mailto:webmaster@rohm.co.jp)