

Deckel

\* = Mass durch Formkonizität nach unten verringert.  
Freimass - Toleranz nach DIN 16901-140

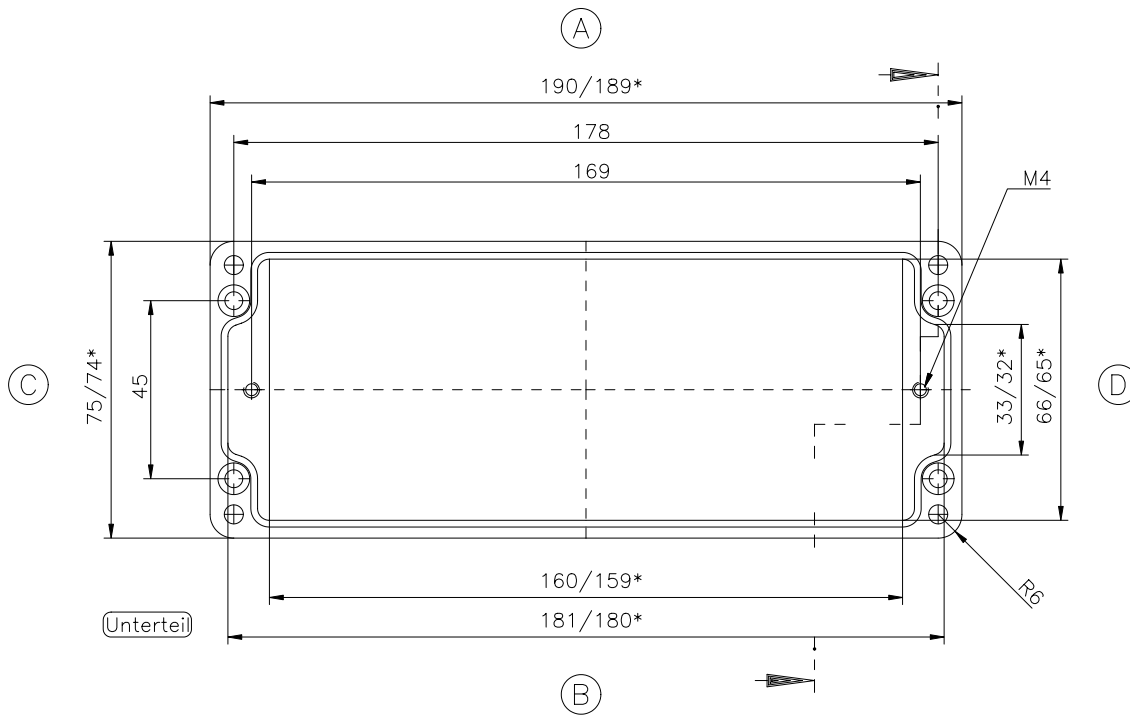

Unterteil

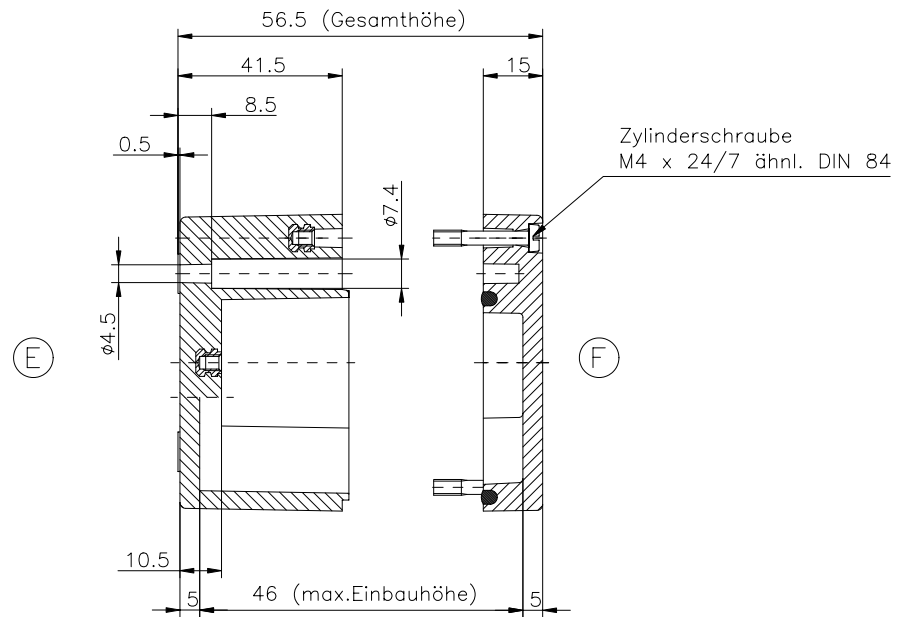

Zylinderschraube  
M4 x 24/7 ähnl. DIN 84