

Golden DRAGON

Lead (Pb) Free Product - RoHS Compliant

LCW W5SM



Released

Besondere Merkmale

- **Gehäusotyp:** weißes SMD Gehäuse, klarer Silikon - Verguss, Chip level conversion
- **Typischer Lichtfluss:** 75 lm bei 350 mA bis zu 154 lm bei 1 A (3500 K)
- **Besonderheit des Bauteils:** hocheffiziente Lichtquelle bei geringem Platzbedarf
- **Farbort:** $x = 0,42$, $y = 0,40$ nach CIE 1931 (weiß)
- **Farbtemperatur:** 2500 K bis 4800 K
- **Farbwiedergabeindex:** 80
- **Abstrahlwinkel:** Lambertscher Strahler (120°)
- **Technologie:** ThinGaN
- **optischer Wirkungsgrad:** 87 lm/W bei 100 mA (3500 K)
- **Gruppierungsparameter:** Lichtstrom, Farbort
- **Verarbeitungsmethode:** für alle SMT-Bestücktechniken geeignet
- **Lötmethode:** Reflow Löten
- **Vorbehandlung:** nach JEDEC Level 2
- **Gurtung:** 24-mm Gurt mit 400/Rolle, $\varnothing 180$ mm
- **ESD-Festigkeit:** ESD-sicher bis 2 kV nach JESD22-A114-D
- **Erweiterte Korrosionsfestigkeit:**
Details siehe Seite 15

Anwendungen

- Raumbelichtung: Deckenbeleuchtung, Nischenbeleuchtung, Kronleuchter, Hängeleuchten, Wandleuchter
- Flutlicht
- Effekt- und Akzentbeleuchtung: Vitrinen, Möbelbeleuchtung, Markierungsbeleuchtung
- Spezialbeleuchtung: Blitzlicht, Radbeleuchtung, Sicherheitsbeleuchtung
- Gebäudebeleuchtung: Fassadenbeleuchtung, Treppenbeleuchtung
- Auto: Innenbeleuchtung, Beleuchtung für Make-up-Spiegel
- Leselampen (z.B. Bus, Flugzeug)

Features

- **package:** white SMD package, colorless clear silicone resin; chip level conversion
- **typical Luminous Flux:** 75 lm at 350 mA up to 154 lm at 1 A (3500 K)
- **feature of the device:** high efficient lightsource at low space
- **color coordinates:** $x = 0.42$, $y = 0.40$ acc. to CIE 1931 (white)
- **color temperature:** 2500 K to 4800 K
- **color reproduction index:** 80
- **viewing angle:** Lambertian Emitter (120°)
- **technology:** ThinGaN
- **optical efficiency:** 87 lm/W at 100 mA (3500 K)
- **grouping parameter:** luminous flux, color coordinates
- **assembly methods:** suitable for all SMT assembly methods
- **soldering methods:** reflow soldering
- **preconditioning:** acc. to JEDEC Level 2
- **taping:** 24 mm tape with 400/reel, $\varnothing 180$ mm
- **ESD-withstand voltage:** up to 2 kV acc. to JESD22-A114-D
- **Superior Corrosion Robustness:**
details see page 15

Applications

- room lighting: ceiling light, cove lighting, chandeliers, pendants, sconces
- flood light
- effect and accent lighting: display cases, furniture illumination, marker lights
- specialty lighting: flashlight, bicycle headlamps, security lights
- architectural lighting: facade lighting, stairway lighting
- automotive interior lighting: dome lighting, make-up mirror illumination
- reading lamps (e.g. bus, airplane)

Bestellinformation
Ordering Information

Typ	Farbtemperatur	Lichtstrom ¹⁾ Seite 22	Lichtstärke ²⁾ Seite 22	Bestellnummer
Type	color temperature	Luminous Flux ¹⁾ page 22	Luminous Intensity ²⁾ page 22	Ordering Code
		$I_F = 350 \text{ mA}$ $\Phi_V \text{ (mlm)}$	$I_F = 350 \text{ mA}$ $I_V \text{ (mcd)}$	
LCW W5SM-JXKX-4U9X	2700 K	45000 ... 82000	18500 (typ.)	Q65110A9692
LCW W5SM-JYKY-4R9T	3000 K	52000 ... 97000	24800 (typ.)	Q65110A9693
LCW W5SM-JXKY-4O9Q	3500 K	45000 ... 97000	24000 (typ.)	Q65110A9681
LCW W5SM-JYKY-4L8N	4000 K	52000 ... 97000	24800 (typ.)	Q65110A9694
LCW W5SM-JYKZ-4J8K	4500 K	52000 ... 112000	27300 (typ.)	Q65110A9698

*Anm.: Die oben genannten Typbezeichnungen umfassen die bestellbaren Selektionen. Diese bestehen aus wenigen Helligkeitsgruppen (siehe **Seite 10** für nähere Informationen). Es wird nur eine einzige Helligkeitsgruppe pro Gurt geliefert. Z.B.: LCW W5SM-JXKX-4U9X bedeutet, dass auf dem Gurt nur eine der Helligkeitsgruppen -JX, -JY, -JZ oder -KX enthalten ist.
Um die Liefersicherheit zu gewährleisten, können einzelne Helligkeitsgruppen nicht bestellt werden.*

*Gleiches gilt für die Farben, bei denen Farbortgruppen gemessen und gruppiert werden. Pro Gurt wird nur eine Farbortgruppe geliefert. Z.B.: LCW W5SM-JXKX-4U9X bedeutet, dass auf dem Gurt nur eine der Farbortgruppen -4U bis -9X enthalten ist (siehe **Seite 5** für nähere Information).
Um die Liefersicherheit zu gewährleisten, können einzelne Farbortgruppen nicht bestellt werden.*

*Note: The above Type Numbers represent the order groups which include only a few brightness groups (see **page 10** for explanation). Only one group will be shipped on each reel (there will be no mixing of two groups on each reel). E.g. LCW W5SM-JXKX-4U9X means that only one group -JX, -JY, -JZ or -KX will be shippable for any one reel.
In order to ensure availability, single brightness groups will not be orderable.*

*In a similar manner for colors where chromaticity coordinate groups are measured and binned, single chromaticity coordinate groups will be shipped on any one reel. E.g. LCW W5SM-JXKX-4U9X means that only 1 chromaticity coordinate group -4U to -9X will be shippable on each reel (see **page 5** for explanation).
In order to ensure availability, single chromaticity coordinate groups will not be orderable.*

Grenzwerte
Maximum Ratings

Bezeichnung Parameter	Symbol Symbol	Wert Value	Einheit Unit
Betriebstemperatur Operating temperature range	T_{op}	- 40 ... + 110	°C
Lagertemperatur Storage temperature range	T_{stg}	- 40 ... + 110	°C
Sperrschichttemperatur Junction temperature	T_j	>150 for short term applications	°C
Sperrschichttemperatur Junction temperature	T_j	125	°C
Durchlassstrom Forward current ($T_S=25^\circ\text{C}$)	(min.) I_F (max.) I_F	100 1000	mA mA
Stoßstrom Surge current $t \leq 10 \mu\text{s}, D = 0.005, T_S=25^\circ\text{C}$	I_{FM}	2000	mA
Sperrspannung Reverse voltage ($T_S=25^\circ\text{C}$)	V_R	not designed for reverse operation	V

Kennwerte
Characteristics

($T_S = 25\text{ °C}$)

Bezeichnung Parameter	Symbol Symbol	Wert Value	Einheit Unit
Farbkoordinate x nach CIE 1931 ³⁾ Seite 22 (typ.) Chromaticity coordinate x acc. to CIE 1931 ³⁾ page 22 $I_F = 350\text{ mA}$	x	0.42	–
Farbkoordinate y nach CIE 1931 ³⁾ Seite 22 (typ.) Chromaticity coordinate y acc. to CIE 1931 ³⁾ page 22 $I_F = 350\text{ mA}$	y	0.40	–
Farbtemperatur ²⁾ Seite 22 (min.) Color temperature ²⁾ page 22 $I_F = 350\text{ mA}$ (max.)	T T T	2500 4800	K K
Abstrahlwinkel bei 50 % I_V (Vollwinkel) (typ.) Viewing angle at 50 % I_V	2φ	120	Grad deg.
Durchlassspannung ⁴⁾ Seite 22 (min.) Forward voltage ⁴⁾ page 22 (typ.) $I_F = 350\text{ mA}$ (max.)	V_F V_F V_F	2.7 3.2 3.7	V V V
Sperrstrom Reverse current (max.)	I_R	not designed for reverse operation	μA
Wärmewiderstand Thermal resistance Sperrschicht/Lötspad (typ.) Junction/soldering point (max.)	$R_{th\ JS}$ $R_{th\ JS}$	6.5 11*	K/W K/W

* $R_{th(max)}$ basiert auf statistischen Werten
 $R_{th(max)}$ is based on statistic values

Farbortgruppen³⁾ Seite 21
 Chromaticity Coordinate Groups³⁾ page 21

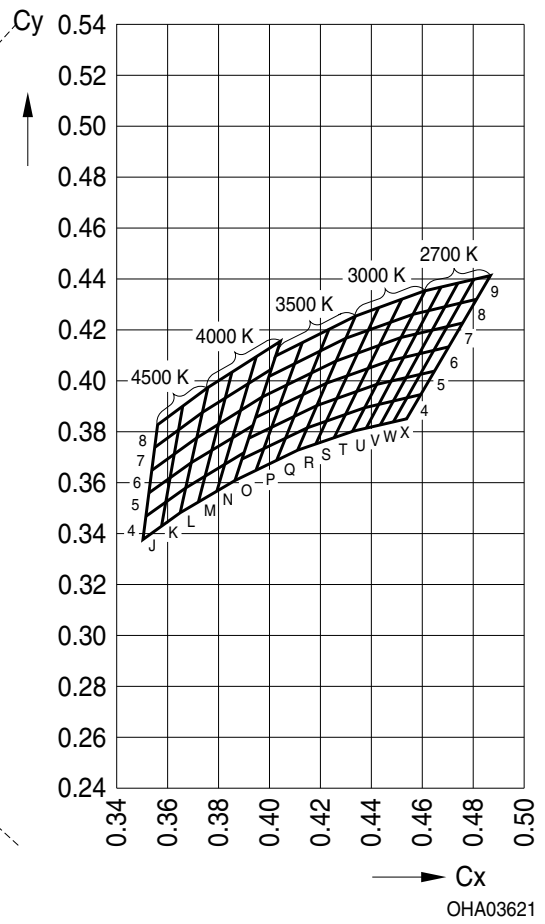
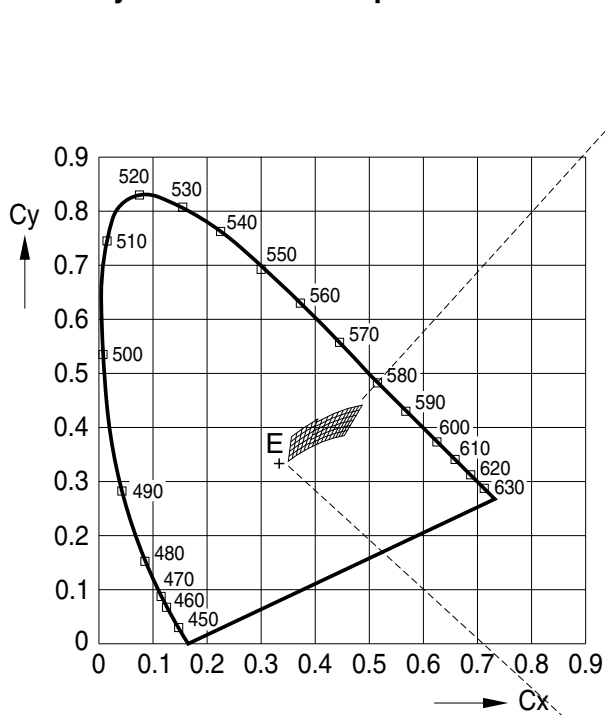

Farbtemperatur 2700 K
Color temperature 2700K

Gruppe Group	Cx	Cy
4U	0.433	0.380
	0.437	0.389
	0.443	0.391
	0.438	0.381
5U	0.437	0.389
	0.442	0.398
	0.448	0.400
	0.443	0.391
6U	0.442	0.398
	0.447	0.408
	0.453	0.409
	0.448	0.400
7U	0.447	0.408
	0.451	0.417
	0.458	0.418
	0.453	0.409
8U	0.451	0.417
	0.456	0.426
	0.462	0.427
	0.458	0.418
9U	0.456	0.426
	0.461	0.435
	0.467	0.437
	0.462	0.427
4V	0.438	0.381
	0.443	0.391
	0.448	0.392
	0.443	0.383
5V	0.443	0.391
	0.448	0.400
	0.453	0.401
	0.448	0.392

Gruppe Group	Cx	Cy
6V	0.448	0.400
	0.453	0.409
	0.459	0.410
	0.453	0.401
7V	0.453	0.409
	0.458	0.418
	0.464	0.420
	0.459	0.410
8V	0.458	0.418
	0.462	0.427
	0.469	0.429
	0.464	0.420
9V	0.462	0.427
	0.467	0.437
	0.474	0.438
	0.469	0.429
4W	0.443	0.383
	0.448	0.392
	0.454	0.393
	0.448	0.384
5W	0.448	0.392
	0.453	0.401
	0.459	0.402
	0.454	0.393
6W	0.453	0.401
	0.459	0.410
	0.464	0.412
	0.459	0.402
7W	0.459	0.410
	0.464	0.420
	0.470	0.421
	0.464	0.412

Gruppe Group	Cx	Cy
8W	0.464	0.420
	0.469	0.429
	0.475	0.430
	0.470	0.421
9W	0.469	0.429
	0.474	0.438
	0.480	0.440
	0.475	0.430
4X	0.448	0.384
	0.454	0.393
	0.459	0.394
	0.454	0.385
5X	0.454	0.393
	0.459	0.402
	0.465	0.404
	0.459	0.394
6X	0.459	0.402
	0.464	0.412
	0.470	0.413
	0.465	0.404
7X	0.464	0.412
	0.470	0.421
	0.476	0.423
	0.470	0.413
8X	0.470	0.421
	0.475	0.430
	0.481	0.432
	0.476	0.423
9X	0.475	0.430
	0.480	0.440
	0.487	0.441
	0.481	0.432

Farbtemperatur 3000 K
Color temperature 3000 K

Gruppe Group	Cx	Cy
4R	0.411	0.373
	0.415	0.381
	0.422	0.384
	0.418	0.375
5R	0.415	0.381
	0.419	0.390
	0.426	0.393
	0.422	0.384
6R	0.419	0.390
	0.422	0.399
	0.430	0.402
	0.426	0.393
7R	0.422	0.399
	0.426	0.408
	0.435	0.411
	0.430	0.402
8R	0.426	0.408
	0.430	0.417
	0.439	0.420
	0.435	0.411
9R	0.430	0.417
	0.434	0.425
	0.443	0.429
	0.439	0.420

Gruppe Group	Cx	Cy
4S	0.418	0.375
	0.422	0.384
	0.430	0.387
	0.425	0.378
5S	0.422	0.384
	0.426	0.393
	0.434	0.396
	0.430	0.387
6S	0.426	0.393
	0.430	0.402
	0.439	0.405
	0.434	0.396
7S	0.430	0.402
	0.435	0.411
	0.443	0.414
	0.439	0.405
8S	0.435	0.411
	0.439	0.420
	0.447	0.423
	0.443	0.414
9S	0.439	0.420
	0.443	0.429
	0.452	0.432
	0.447	0.423

Gruppe Group	Cx	Cy
4T	0.425	0.378
	0.430	0.387
	0.437	0.389
	0.433	0.380
5T	0.430	0.387
	0.434	0.396
	0.442	0.398
	0.437	0.389
6T	0.434	0.396
	0.439	0.405
	0.447	0.408
	0.442	0.398
7T	0.439	0.405
	0.443	0.414
	0.451	0.417
	0.447	0.408
8T	0.443	0.414
	0.447	0.423
	0.456	0.426
	0.451	0.417
9T	0.447	0.423
	0.452	0.432
	0.461	0.435
	0.456	0.426

Farbtemperatur 3500 K
Color temperature 3500 K

Gruppe Group	Cx	Cy
40	0.386	0.361
	0.389	0.369
	0.398	0.373
	0.394	0.365
50	0.389	0.369
	0.392	0.377
	0.401	0.381
	0.398	0.373
60	0.392	0.377
	0.394	0.385
	0.404	0.390
	0.401	0.381
70	0.394	0.385
	0.397	0.393
	0.407	0.398
	0.404	0.390
80	0.397	0.393
	0.400	0.401
	0.410	0.408
	0.407	0.398
90	0.400	0.401
	0.402	0.410
	0.413	0.415
	0.410	0.406

Gruppe Group	Cx	Cy
4P	0.394	0.365
	0.398	0.373
	0.406	0.377
	0.403	0.369
5P	0.398	0.373
	0.401	0.381
	0.410	0.386
	0.406	0.377
6P	0.401	0.381
	0.404	0.390
	0.413	0.394
	0.410	0.386
7P	0.404	0.390
	0.407	0.398
	0.416	0.403
	0.413	0.394
8P	0.407	0.398
	0.410	0.406
	0.420	0.412
	0.416	0.403
9P	0.410	0.406
	0.413	0.415
	0.423	0.420
	0.420	0.412

Gruppe Group	Cx	Cy
4Q	0.403	0.369
	0.406	0.377
	0.415	0.381
	0.411	0.373
5Q	0.406	0.377
	0.410	0.386
	0.419	0.390
	0.415	0.381
6Q	0.410	0.386
	0.413	0.394
	0.422	0.399
	0.419	0.390
7Q	0.413	0.394
	0.416	0.403
	0.426	0.408
	0.422	0.399
8Q	0.416	0.403
	0.420	0.412
	0.430	0.417
	0.426	0.408
9Q	0.420	0.412
	0.423	0.420
	0.434	0.425
	0.430	0.417

Farbtemperatur 4000 K
Color temperature 4000 K

Gruppe Group	Cx	Cy
4L	0.365	0.348
	0.367	0.358
	0.375	0.362
	0.372	0.352
5L	0.367	0.358
	0.369	0.368
	0.377	0.373
	0.375	0.362
6L	0.369	0.368
	0.371	0.378
	0.380	0.383
	0.377	0.373
7L	0.371	0.378
	0.374	0.387
	0.383	0.393
	0.380	0.383
8L	0.374	0.387
	0.376	0.397
	0.385	0.403
	0.383	0.393

Gruppe Group	Cx	Cy
4M	0.372	0.352
	0.375	0.362
	0.382	0.367
	0.379	0.356
5M	0.375	0.362
	0.377	0.373
	0.385	0.378
	0.382	0.367
6M	0.377	0.373
	0.380	0.383
	0.388	0.388
	0.385	0.376
7M	0.380	0.383
	0.383	0.393
	0.392	0.399
	0.388	0.388
8M	0.383	0.393
	0.385	0.403
	0.395	0.409
	0.392	0.399

Gruppe Group	Cx	Cy
4N	0.379	0.356
	0.382	0.367
	0.390	0.372
	0.386	0.361
5N	0.382	0.367
	0.385	0.376
	0.393	0.383
	0.390	0.372
6N	0.385	0.378
	0.388	0.388
	0.397	0.393
	0.393	0.383
7N	0.388	0.388
	0.392	0.399
	0.401	0.404
	0.397	0.393
8N	0.392	0.399
	0.395	0.409
	0.404	0.415
	0.401	0.404

Farbtemperatur 4500 K
Color temperature 4500 K

Gruppe Group	Cx	Cy
4J	0.350	0.337
	0.351	0.347
	0.359	0.352
	0.357	0.343
5J	0.351	0.347
	0.352	0.356
	0.361	0.362
	0.359	0.352
6J	0.352	0.356
	0.354	0.365
	0.363	0.371
	0.361	0.362
7J	0.354	0.365
	0.355	0.374
	0.364	0.381
	0.363	0.371

Gruppe Group	Cx	Cy
8J	0.355	0.374
	0.356	0.383
	0.366	0.390
	0.364	0.381
4K	0.357	0.343
	0.359	0.352
	0.367	0.358
	0.365	0.348
5K	0.359	0.352
	0.361	0.362
	0.369	0.368
	0.367	0.358

Gruppe Group	Cx	Cy
6K	0.361	0.362
	0.363	0.371
	0.371	0.378
	0.369	0.368
7K	0.363	0.371
	0.364	0.381
	0.374	0.387
	0.371	0.378
8K	0.364	0.381
	0.366	0.390
	0.376	0.397
	0.374	0.387

Helligkeits-Gruppierungsschema
Brightness Groups

Helligkeitsgruppe Brightness Group	Lichtstrom ^{1) Seite 22} Luminous Flux ^{1) page 22} Φ_v (lm)	Lichtstärke ^{2) Seite 22} Luminous Intensity ^{2) page 22} I_v (mcd)
JX	45000 ... 52000	16200 (typ.)
JY	52000 ... 61000	18800 (typ.)
JZ	61000 ... 71000	22000 (typ.)
KX	71000 ... 82000	25500 (typ.)
KY	82000 ... 97000	30000 (typ.)
KZ	97000 ... 112000	34800 (typ.)

Anm.: Die Standardlieferform von Serientypen beinhaltet eine Familiengruppe. Diese besteht aus wenigen Helligkeitsgruppen. Einzelne Helligkeitsgruppen sind nicht bestellbar.

Note: The standard shipping format for serial types includes a family group of only a few individual brightness groups. Individual brightness groups cannot be ordered.

Gruppenbezeichnung auf Etikett
Group Name on Label

Beispiel: JX-4U

Example: JX-4U

Helligkeitsgruppe Brightness Group	Farbortgruppe Chromaticity Coordinate Group
JX	4U

Anm.: In einer Verpackungseinheit / Gurt ist immer nur eine Helligkeitsgruppe enthalten.

Note: No packing unit / tape ever contains more than one brightness group.

Relative spektrale Emission²⁾ Seite 22

Relative Spectral Emission²⁾ page 22

$V(\lambda)$ = spektrale Augenempfindlichkeit / Standard eye response curve

$\Phi_{rel} = f(\lambda); T_S = 25\text{ °C}; I_F = 350\text{ mA}$

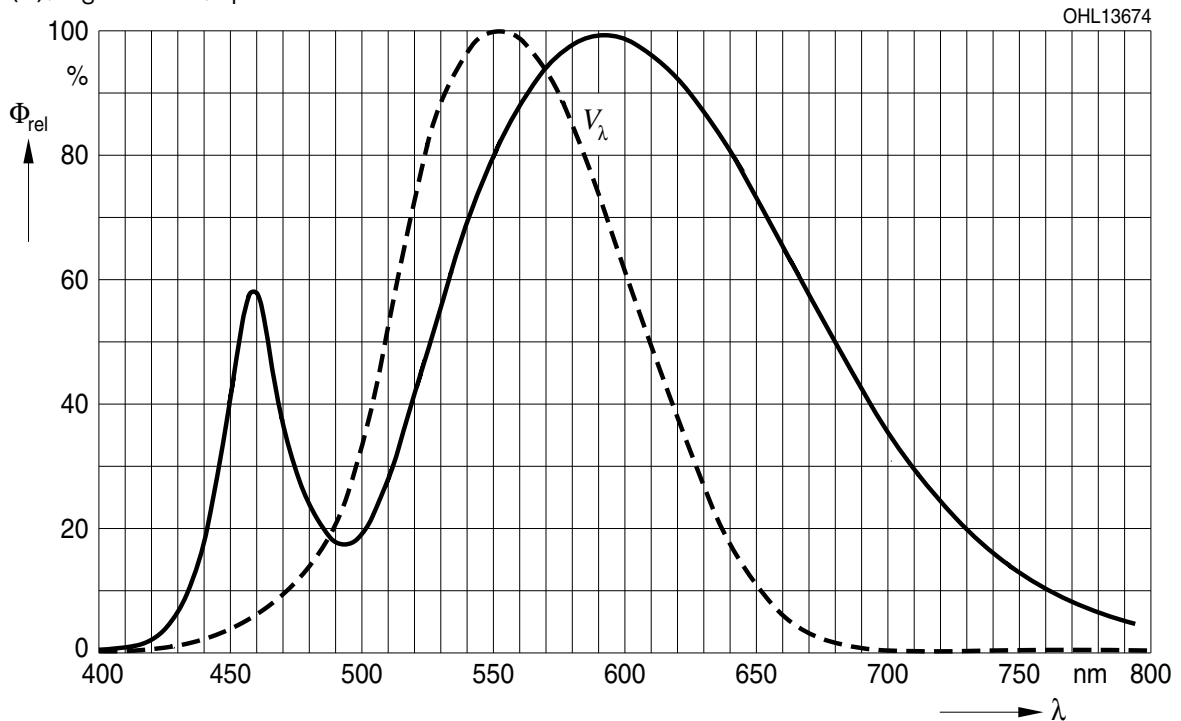

Abstrahlcharakteristik²⁾ Seite 22

Radiation Characteristic²⁾ page 22

$I_{rel} = f(\varphi); T_S = 25\text{ °C}$

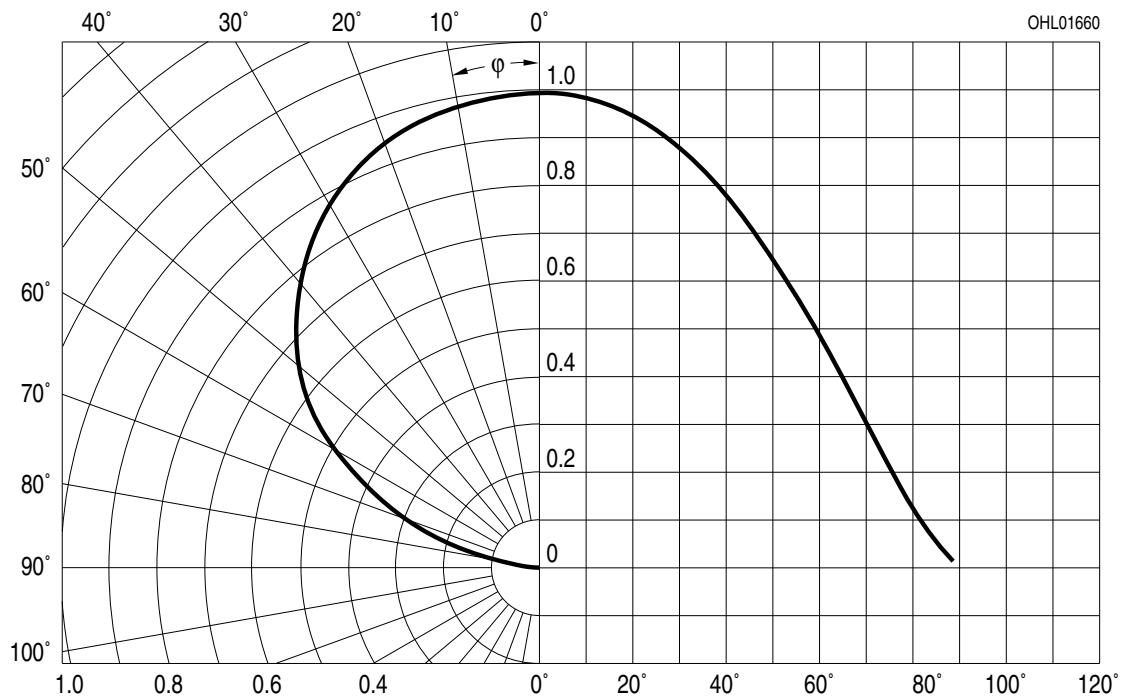

Durchlassstrom²⁾⁴⁾ Seite 22

Forward Current²⁾⁴⁾ page 22

$$I_F = f(V_F); T_S = 25\text{ }^\circ\text{C}$$

solid line: specified DC-range

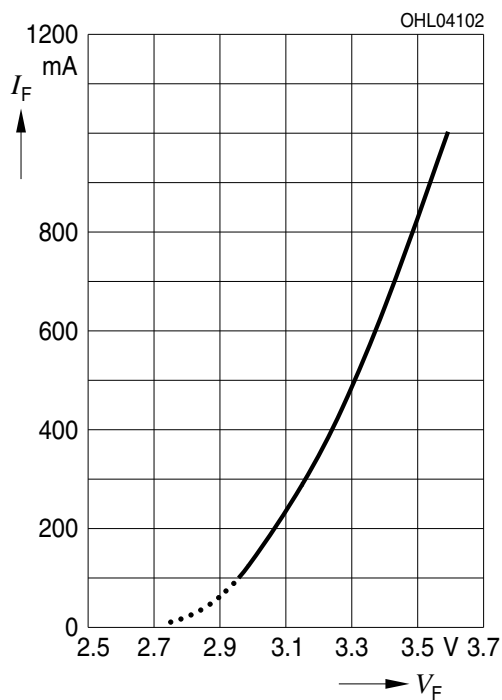

Relative Lichtstrom^{2) 5)} Seite 22

Relative Luminous Flux^{2) 5)} page 22

$$\Phi_V / \Phi_V(350\text{ mA}) = f(I_F); T_S = 25\text{ }^\circ\text{C}$$

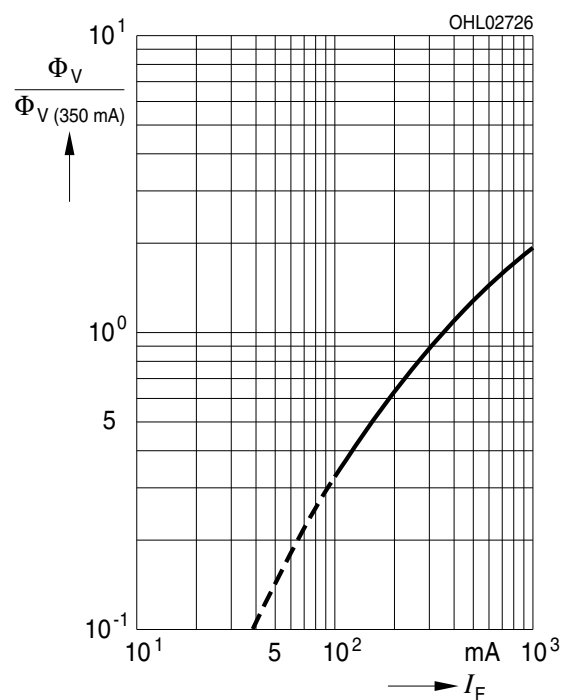

Farbortverschiebung²⁾ Seite 17

Chromaticity Coordinate Shift²⁾ page 17

$$x, y = f(I_F); T_S = 25\text{ }^\circ\text{C}$$

solid line: specified DC-range

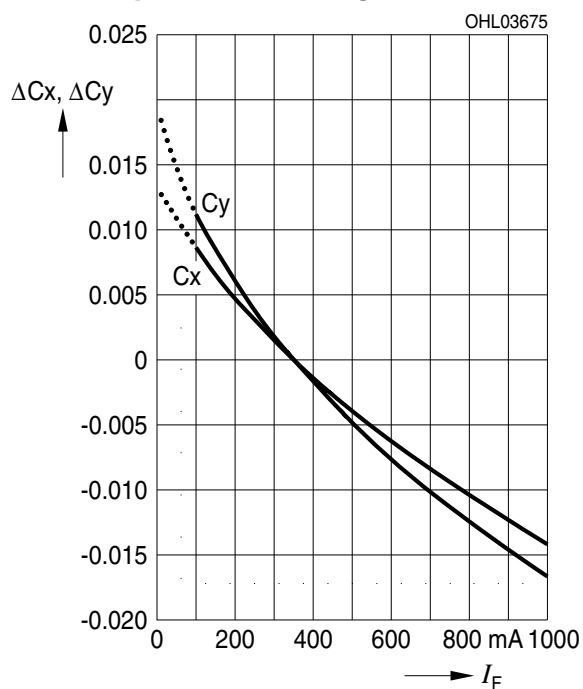

Relative Vorwärtsspannung^{2)4) Seite 17}

Relative Forward Voltage^{2)4) page 17}

$\Delta V_F = V_F - V_F(25\text{ °C}) = f(T_j); I_F = 350\text{ mA}$

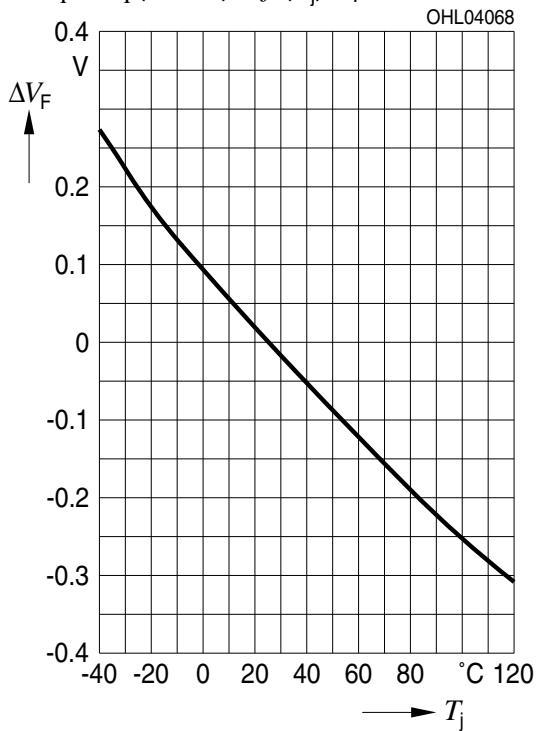

Relative Lichtstrom^{2) Seite 22}

Relative Luminous Flux^{2) page 22}

$\Phi_V/\Phi_V(25\text{ °C}) = f(T_j); I_F = 350\text{ mA}$

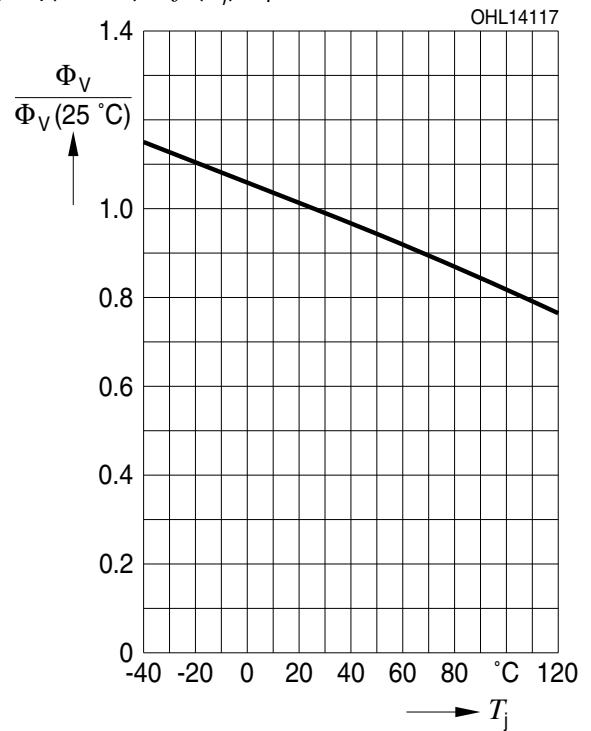

Farbortverschiebung^{2) Seite 22}

Chromaticity Coordinate Shift^{2) page 22}

$x, y = f(T_j); I_F = 350\text{ mA}$

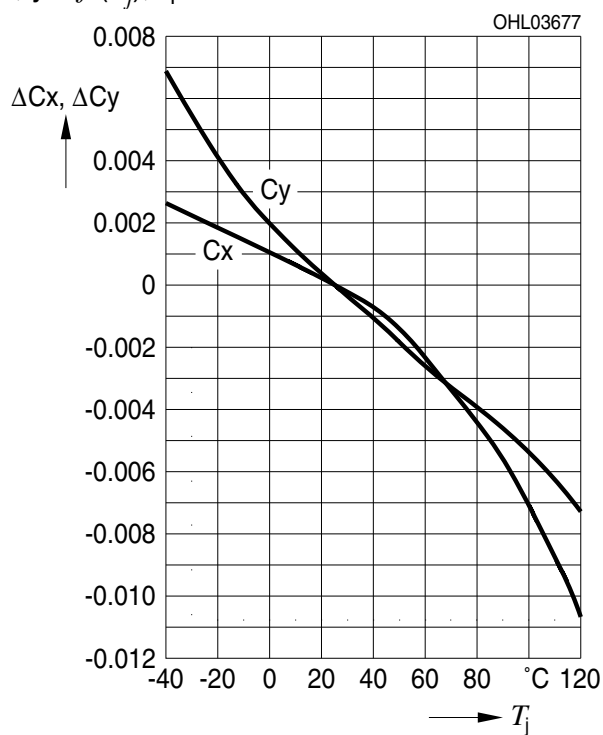

Maximal zulässiger Durchlassstrom
Max. Permissible Forward Current

$I_F = f(T_S)$

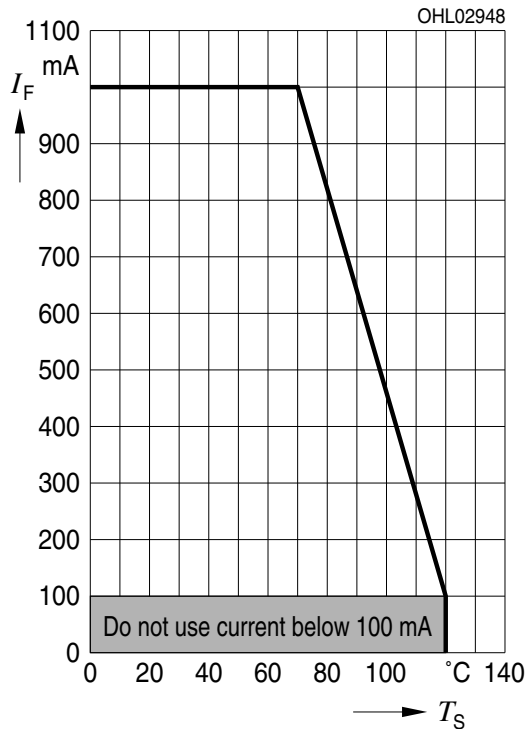

Zu Lebensdauerangaben siehe
 Applikationsschrift: **“Reliability of the DRAGON
 Product Family”**
 For life time information please refer to application
 note **“Reliability of the DRAGON Product
 Family”**

Zulässige Impulsbelastbarkeit $I_F = f(t_p)$
Permissible Pulse Handling Capability

Duty cycle $D =$ parameter, $T_S = 25\text{ °C}$

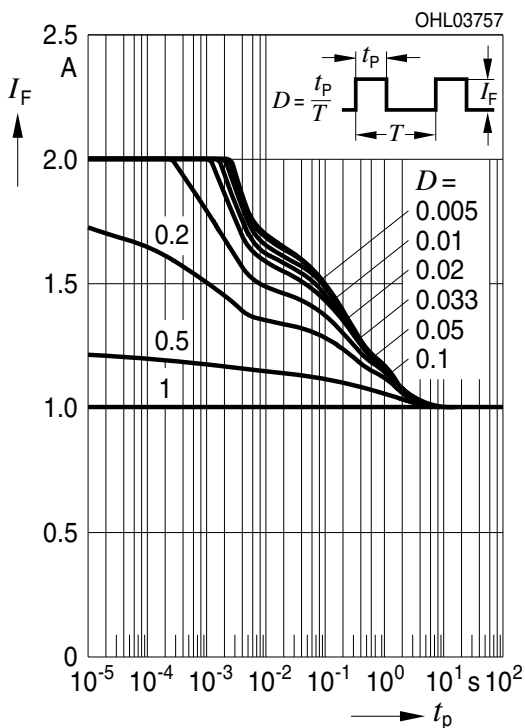

Zulässige Impulsbelastbarkeit $I_F = f(t_p)$
Permissible Pulse Handling Capability

Duty cycle $D =$ parameter, $T_S = 85\text{ °C}$

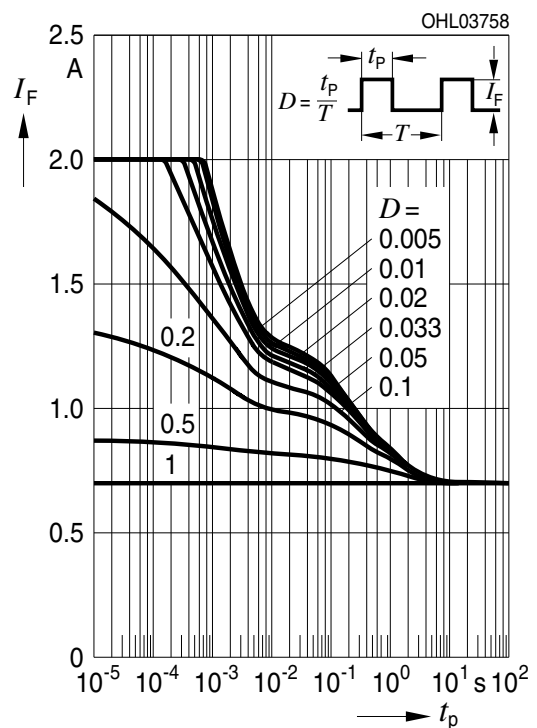

Maßzeichnung⁶⁾ Seite 22
 Package Outlines⁶⁾ page 22

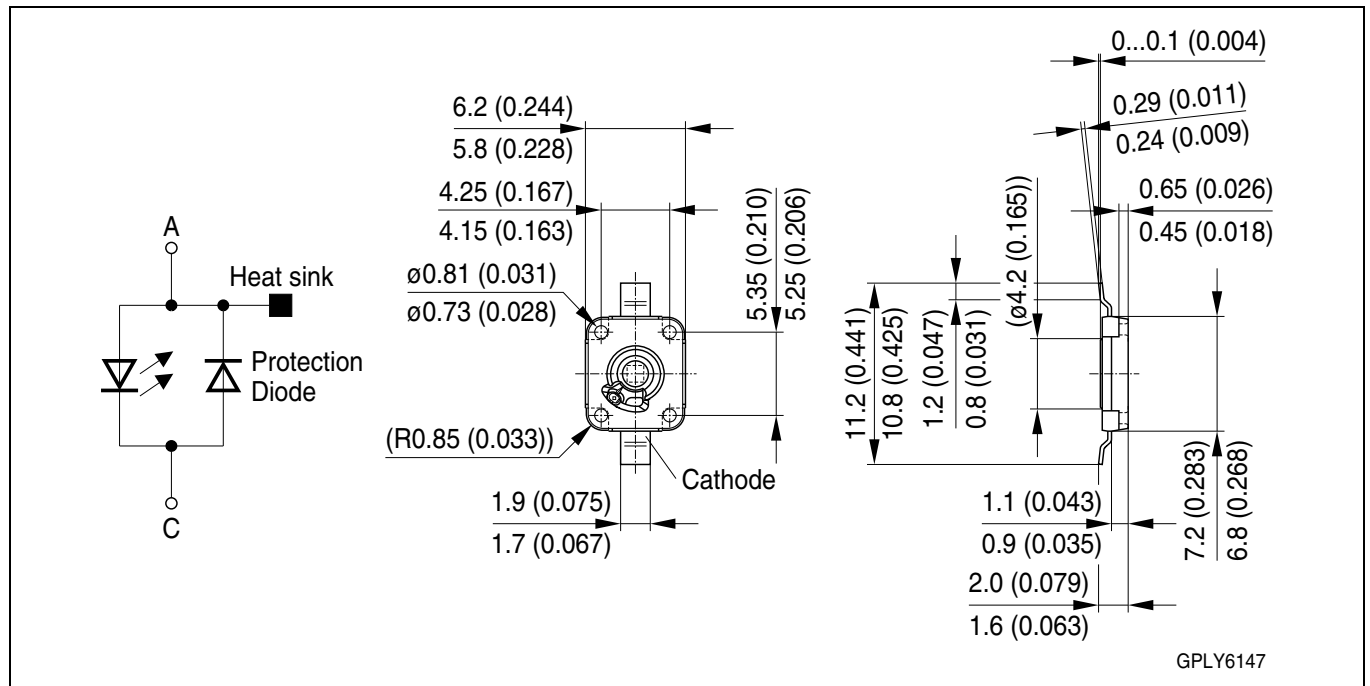

Korrosionsfestigkeit besser als EN 60068-2-60 (method 4):
 mit erweitertem Korrosionstest: 40°C / 90%rh / 15ppm H₂S / 336h
Corrosion robustness better than EN 60068-2-60 (method 4):
 with enhanced corrosion test: 40°C / 90%rh / 15ppm H₂S / 336h

Kathodenkennung:
Cathode mark:
Gewicht / Approx. weight:

Markierung
 mark
 0.2 g

Gurtung / Polarität und Lage⁶⁾ Seite 22
Method of Taping / Polarity and Orientation⁶⁾ page 22

Verpackungseinheit 400/Rolle, ø180 mm
Packing unit 400/reel, ø180 mm

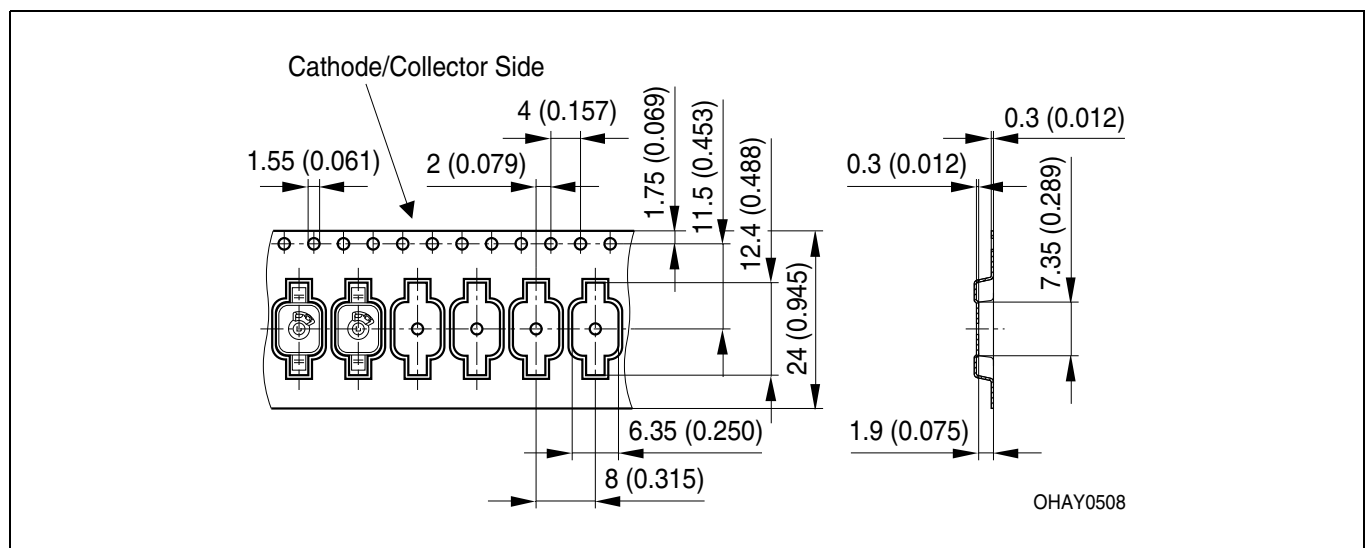

Achtung:
 Anode und
 Heatsink sind
 elektrisch
 verbunden

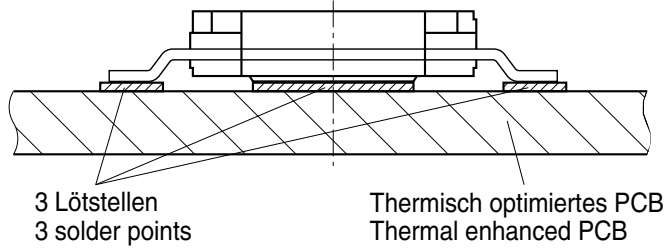



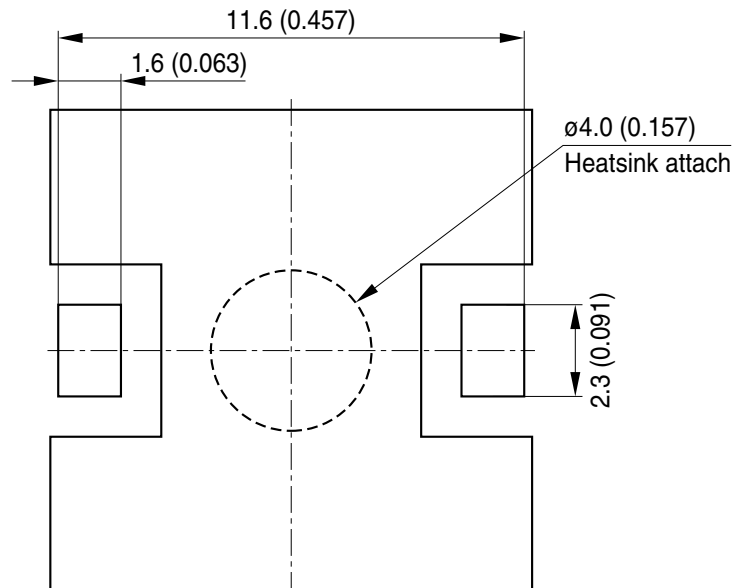

Attention:
 Anode and
 Heatsink are
 electrically
 connected

Footprint

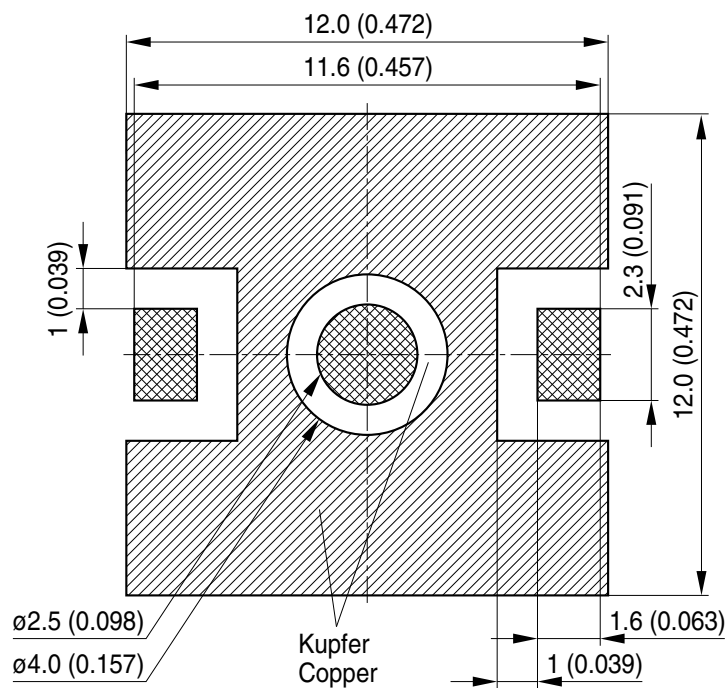

Empfohlene
 Padgeometrie
 Recommended
 Solder Pad
 Design



-  Lötstopplack
Solder resist
-  Lötpasten Schablone
Solder paste stencil
-  Freies Kupfer
Bare Copper

OHPY3637

Lötbedingungen
Soldering Conditions

Reflow Lötprofil für bleifreies Löten
Reflow Soldering Profile for lead free soldering

Vorbehandlung nach JEDEC Level 2
 Preconditioning acc. to JEDEC Level 2
 (nach J-STD-020C)
 (acc. to J-STD-020C)

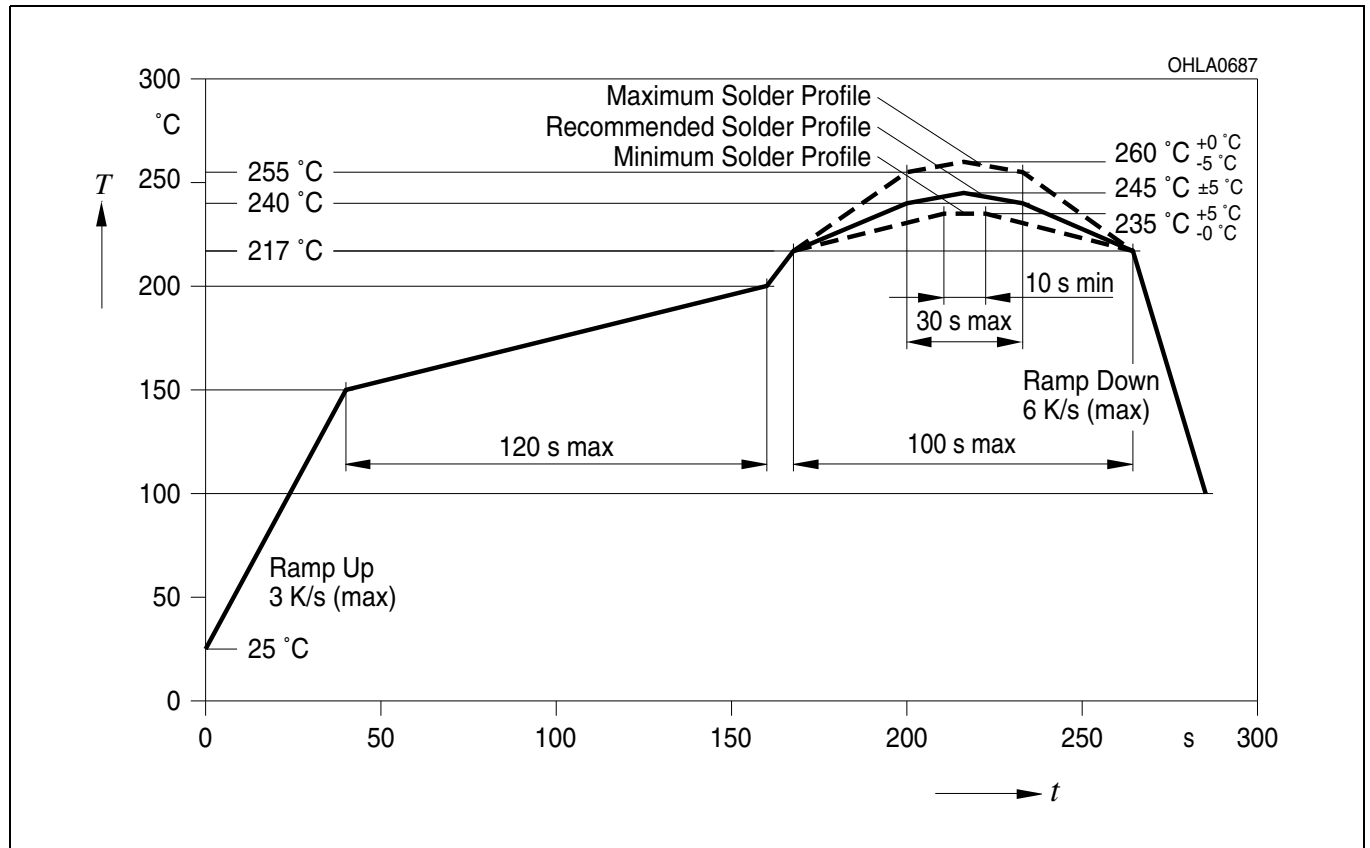

Anm.: Das Gehäuse ist für Ultraschallreinigung nicht geeignet
Note: Package not suitable for ultra sonic cleaning

Barcode-Produkt-Etikett (BPL)
Barcode-Product-Label (BPL)

OSRAM Opto Semiconductors

Lx xxxx Bin1: Bin Information Color 1
 Product Name Bin2:
 Bin3:

(6P) BATCH NO: Batch Number
Bar Code

RoHS Compliant ML Temp ST
 2 260 C RT

(1T) LOT NO: Lot Number (9D) D/C: Date Code
Bar Code

Additional TEXT
 R077 DEMY
 PACKVAR: Packing Type

(X) PROD NO: Product Code (Q)QTY: Product Quantity per Reel (G) GROUP: X - X - X
 Forward Voltage Group
 Wavelength Group
 Brightness Group

OHA12043

Gurtverpackung
Tape and Reel

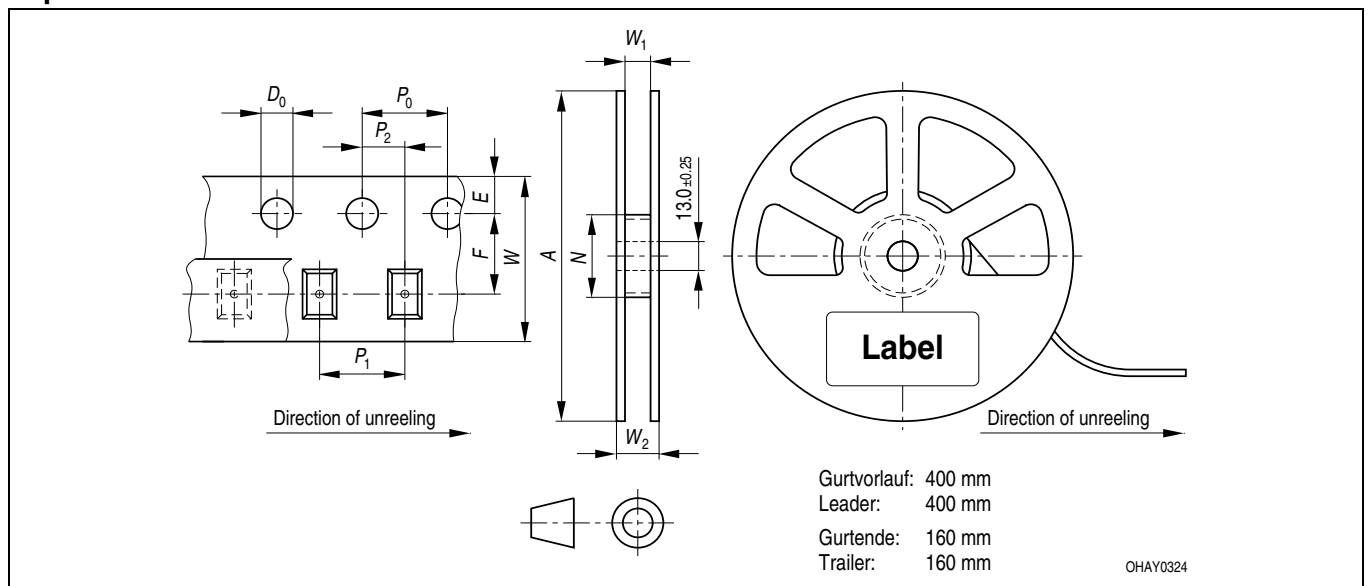

Tape dimensions in mm (inch)

W	P_0	P_1	P_2	D_0	E	F
$24^{+0.3}_{-0.1}$	4 ± 0.1 (0.157 ± 0.004)	8 ± 0.1 (0.315 ± 0.004)	2 ± 0.1 (0.079 ± 0.004)	1.5 ± 0.1 (0.059 ± 0.004)	1.75 ± 0.1 (0.069 ± 0.004)	11.5 ± 0.1 (0.453 ± 0.004)

Reel dimensions in mm (inch)

A	W	N_{min}	W_1	W_2_{max}
180 (7)	24 (0.945)	60 (2.362)	$24.4 + 2$ (0.961 + 0.079)	30.4 (1.197)

Trockenverpackung und Materialien
Dry Packing Process and Materials

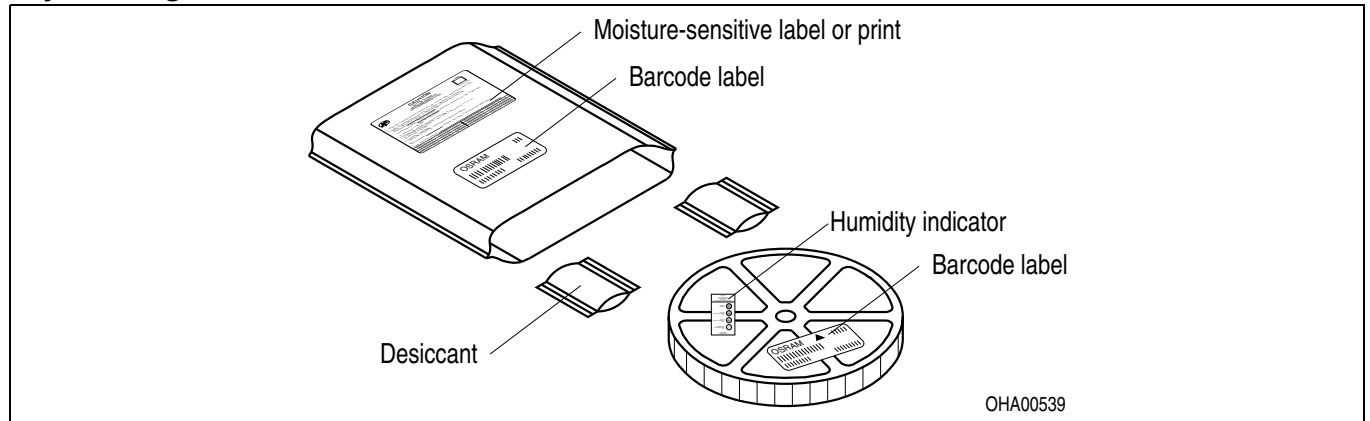

Anm.: Feuchteempfindliche Produkte sind verpackt in einem Trockenbeutel zusammen mit einem Trockenmittel und einer Feuchteindikatorkarte
 Bezüglich Trockenverpackung finden Sie weitere Hinweise im Internet und in unserem Short Form Catalog im Kapitel "Gurtung und Verpackung" unter dem Punkt "Trockenverpackung". Hier sind Normenbezüge, unter anderem ein Auszug der JEDEC-Norm, enthalten.

Note: Moisture-sensitive product is packed in a dry bag containing desiccant and a humidity card.
 Regarding dry pack you will find further information in the internet and in the Short Form Catalog in chapter "Tape and Reel" under the topic "Dry Pack". Here you will also find the normative references like JEDEC.

Kartonverpackung und Materialien
Transportation Packing and Materials

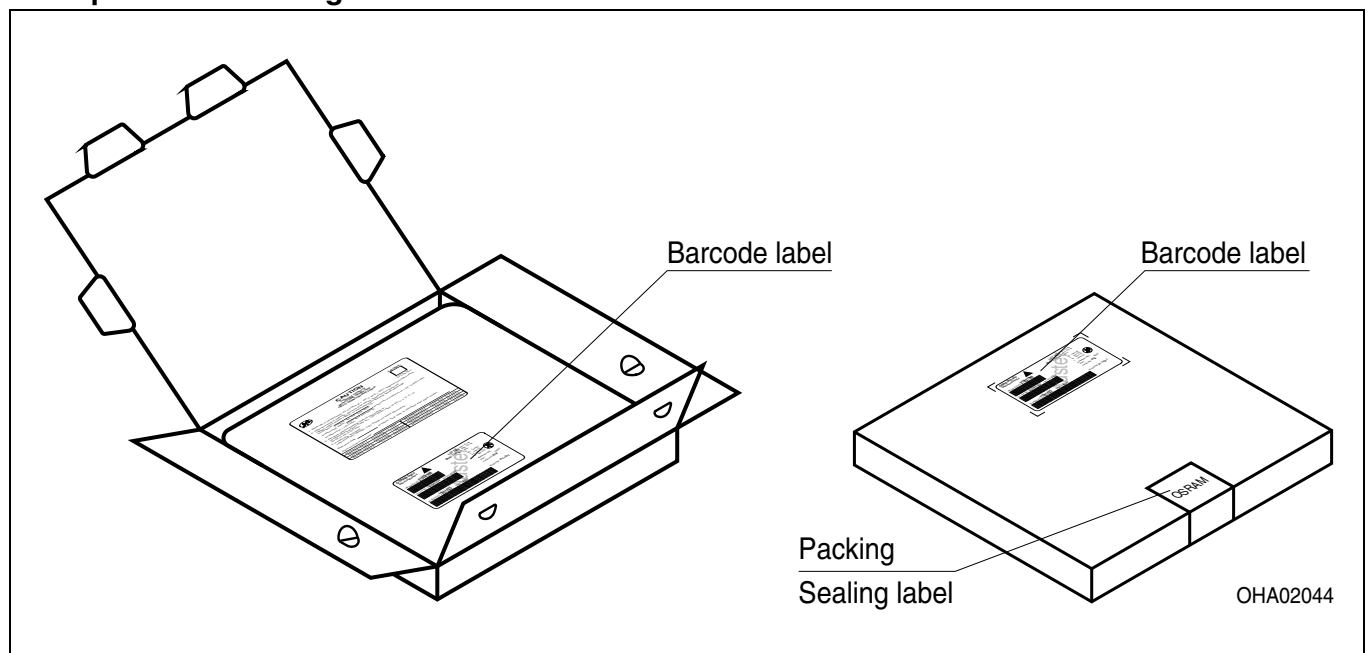

Dimensions of transportation box in mm (inch)

Breite / Width	Länge / length	Höhe / height
195 ±5 (7,677 ±0,1968±)	195 ±5 (7,677 ±0,1968)	42 ±5 (1,6535 ±0,1968)

Revision History: 2009-12-16

Previous Version: 2009-12-08

Page	Subjects (major changes since last revision)	Date of change
1, 14	OS-IN-2007-018 (Introduction of Jedec Level 2)	2007-08-16
all	OS-PCN-2007-003-A	2008-02-01
all	OS-IN-2008-002	2008-11-17
4	OS-IN-2009-020 (Forward voltage max reduced)	2009-06-16
2, 10	Ordering codes changed/removed	2009-10-26
1, 15	Additional information	2009-12-08
all	data sheet reworked	2009-12-16

Wegen der Streichung der LED aus der IEC 60825-1 (2nd edition 2007-03) erfolgt die Bewertung der Augesicherheit nach dem Standard CIE S009/E:2002 ("photobiological safety of lamps and lamp systems") / IEC 62471 (1st edition 2006-07).

Im Risikogruppensystem dieser CIE- Norm erfüllen die in diesem Datenblatt angegebenen LED die "moderate risk"- Gruppe (die die sich im "sichtbaren" Spektralbereich auf eine Expositionsdauer von 0,25 s bezieht). Unter realen Umständen (für Expositionsdauer, Augenpupille, Betrachtungsabstand) geht damit von diesen Bauelementen keinerlei Augengefährdung aus. Grundsätzlich sollte jedoch erwähnt werden, dass intensive Lichtquellen durch ihre Blendwirkung ein hohes sekundäres Gefahrenpotenzial besitzen. Wie nach dem Blick in andere helle Lichtquellen (z.B. Autoscheinwerfer) auch, können temporär eingeschränktes Sehvermögen und Nachbilder je nach Situation zu Irritationen, Belästigungen, Beeinträchtigungen oder sogar Unfällen führen.

Due to the cancellation of the LED from IEC 608251 (2nd edition 2007-03) , the evaluation of eye safety occurs according to the dual IEC/CIE logo standard CIE S009/E:2002 ("photobiological safety of lamps and lamp systems")-

IEC 62471 (1st edition 2006-07).

Within the risk grouping system of this CIE standard, the LEDs specified in this data sheet fall into the "moderate risk" group (relating to devices in the visible spectrum with an exposure time of 0.25s). Under real circumstances (for exposure time, eye pupils, observation distance), it is assumed that no endangerment to the eye exists from these devices.

As a matter of principle, however, it should be mentioned that intense light sources have a high secondary exposure potential due to their blinding effect. As is also true when viewing other bright light sources (e.g. headlights), temporary reduction in visual acuity and afterimages can occur, leading to irritation, annoyance, visual impairment, and even accidents, depending on the situation.

Patent List**Patent No.**

US 6 066 861
US 6 277 301
US 6 245 259

Attention please!

The information describes the type of component and shall not be considered as assured characteristics. Terms of delivery and rights to change design reserved. Due to technical requirements components may contain dangerous substances. For information on the types in question please contact our Sales Organization. If printed or downloaded, please find the latest version in the Internet.

Packing

Please use the recycling operators known to you. We can also help you – get in touch with your nearest sales office. By agreement we will take packing material back, if it is sorted. You must bear the costs of transport. For packing material that is returned to us unsorted or which we are not obliged to accept, we shall have to invoice you for any costs incurred.

Components used in life-support devices or systems must be expressly authorized for such purpose! Critical components^{7) page 22} may only be used in life-support devices or systems^{8) page 22} with the express written approval of OSRAM OS.

Fußnoten:

- 1) Helligkeitswerte werden während eines Strompulses einer typischen Dauer von 25 ms, mit einer internen Reproduzierbarkeit von +/- 8 % und einer erweiterten Messunsicherheit von +/- 11 % gemessen (gemäß GUM mit Erweiterungsfaktor $k = 3$).
- 2) Wegen der besonderen Prozessbedingungen bei der Herstellung von LED können typische oder abgeleitete technische Parameter nur aufgrund statistischer Werte wiedergegeben werden. Diese stimmen nicht notwendigerweise mit den Werten jedes einzelnen Produktes überein, dessen Werte sich von typischen und abgeleiteten Werten oder typischen Kennlinien unterscheiden können. Falls erforderlich, z.B. aufgrund technischer Verbesserungen, werden diese typischen Werte ohne weitere Ankündigung geändert.
- 3) Farbkoordinaten werden während eines Strompulses einer typischen Dauer von 25 ms, mit einer internen Reproduzierbarkeit von +/- 0,005 und einer erweiterten Messunsicherheit von +/- 0,01 gemessen (gemäß GUM mit Erweiterungsfaktor $k = 3$).
- 4) Vorwärtsspannungen werden während eines Strompulses einer typischen Dauer von 8 ms, mit einer internen Reproduzierbarkeit von +/- 0,05 V und einer erweiterten Messunsicherheit von +/- 0,1 V gemessen (gemäß GUM mit Erweiterungsfaktor $k=3$).
- 5) Im gestrichelten Bereich der Kennlinien muss mit erhöhten Helligkeitsunterschieden zwischen Leuchtdioden innerhalb einer Verpackungseinheit gerechnet werden
- 6) Maße werden wie folgt angegeben: mm (inch)
- 7) Ein kritisches Bauteil ist ein Bauteil, das in lebenserhaltenden Apparaten oder Systemen eingesetzt wird und dessen Defekt voraussichtlich zu einer Fehlfunktion dieses lebenserhaltenden Apparates oder Systems führen wird oder die Sicherheit oder Effektivität dieses Apparates oder Systems beeinträchtigt.
- 8) Lebenserhaltende Apparate oder Systeme sind für
 - (a) die Implantierung in den menschlichen Körper oder
 - (b) für die Lebenserhaltung bestimmt.
 Falls sie versagen, kann davon ausgegangen werden, dass die Gesundheit und das Leben des Patienten in Gefahr ist.

Remarks:

- 1) Brightness values are measured during a current pulse of typical 25 ms, with an internal reproducibility of +/- 8 % and an expanded uncertainty of +/- 11 % (acc. to GUM with an expansion factor of $k = 3$).
- 2) Due to the special conditions of the manufacturing processes of LED, the typical data or calculated correlations of technical parameters can only reflect statistical figures. These do not necessarily correspond to the actual parameters of each single product, which could differ from the typical data and calculated correlations or the typical characteristic line. If requested, e.g. because of technical improvements, these typ. data will be changed without any further notice.
- 3) Chromaticity coordinates are measured during a current pulse of typical 25 ms, with an internal reproducibility of +/- 0,005 and an expanded uncertainty of +/- 0,01 (acc. to GUM with an expansion factor of $k = 3$).
- 4) The forward voltage is measured during a current pulse of typical 8 ms, with an internal reproducibility of +/- 0,05 V and an expanded uncertainty of +/- 0,1 V (acc. to GUM with an expansion factor of $k=3$).
- 5) In the range where the line of the graph is broken, you must expect higher brightness differences between single LEDs within one packing unit.
- 6) Dimensions are specified as follows: mm (inch).
- 7) A critical component is a component used in a life-support device or system whose failure can reasonably be expected to cause the failure of that life-support device or system, or to affect its safety or the effectiveness of that device or system.
- 8) Life support devices or systems are intended
 - (a) to be implanted in the human body,
 - or
 - (b) to support and/or maintain and sustain human life.
 If they fail, it is reasonable to assume that the health and the life of the user may be endangered.

Published by
OSRAM Opto Semiconductors GmbH
 Leibnizstraße 4, D-93055 Regensburg
www.osram-os.com
 © All Rights Reserved.

EU RoHS and China RoHS compliant product



此产品符合欧盟 RoHS 指令的要求；

按照中国的相关法规和标准，不含有毒有害物质或元素。