

M22 Connectors Specification

- ❖ 2mm pitch, with 0.5mm square male pin connection system.
- ❖ Board-to-Board and Cable-to-Board application options.

❖ Materials

Mouldings:	Standard or High Temperature Plastic, UL94V-0
Contacts	
Female:	Phosphor Bronze
Jumper socket:	Beryllium Copper
Male:	Copper Alloy
Finish:	See individual pages

❖ Electrical

Current:	Up to 2A per contact (see individual drawings)
Voltage proof:	500V AC for 1 minute
Contact resistance:	30mΩ max
Insulation resistance:	500MΩ min

❖ Mechanical

Durability	
M22-30X:	25 operations
Others:	300 operations
Insertion force (max)	
Jumper sockets:	10N total
M22-30X:	2.9N per contact
Others:	2.0N per contact
Withdrawal force (min)	
Jumper sockets:	1N total
M22-30X:	1.0N per contact
Others:	0.2N per contact
Vibration sensitivity	
M22-654, 655:	50 – 2,000Hz, 3.13G, 45 minutes duration
Others:	10 – 55Hz, 1.5mm, 6 hours duration
Shock severity:	294m/s ² (30G) for 11ms

❖ Environmental

Operating temperature	
M22-30X:	-25°C to +85°C
Others:	-40°C to +105°C
Solderability	
M22-636, 713, 714:	250°C for 3 seconds
Others:	245°C for 5 seconds
Soldering heat resistance:	260°C for 10 seconds

M22 Connectors Mating Profiles

2mm (.079") PITCH

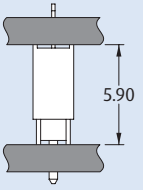
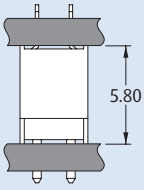
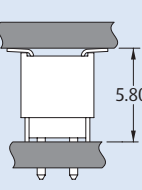
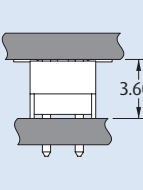
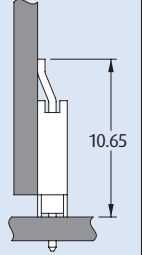
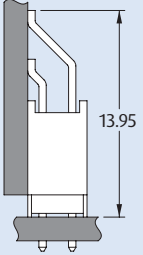
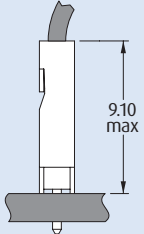
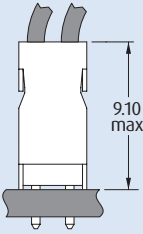
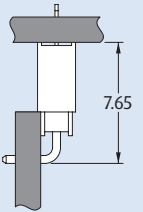
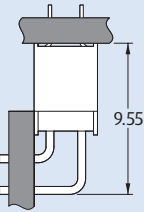
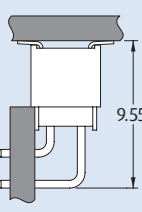
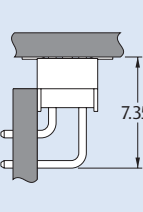
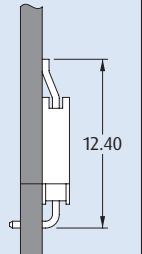
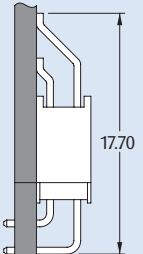
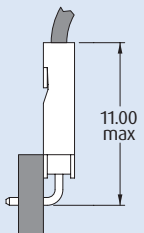
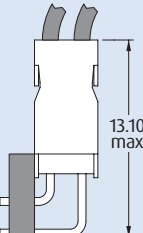
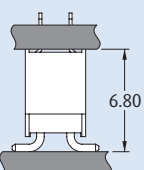
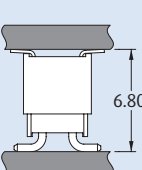
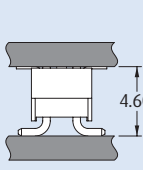
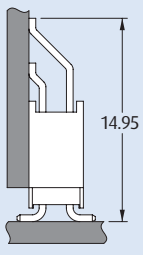
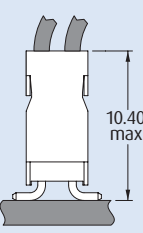
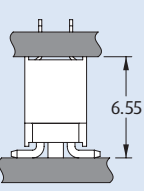
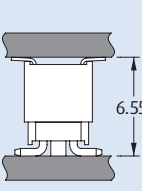
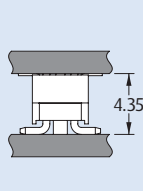
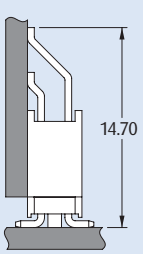
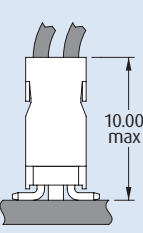
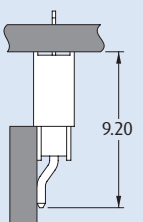
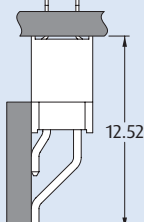
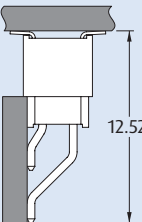
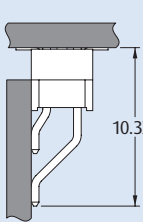
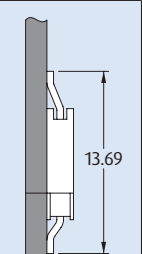
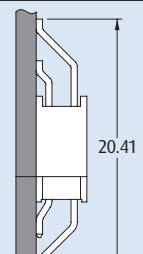
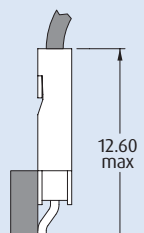
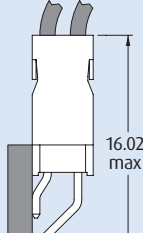
		FEMALE							
		VERTICAL PC TAIL		VERTICAL SMT	VERTICAL SMT Low Profile	HORIZONTAL SMT		CRIMP	
		SIL	DIL	DIL	DIL	SIL	DIL	SIL	DIL
MALE	VERTICAL PC TAIL								
	HORIZONTAL PC TAIL								
	VERTICAL SMT								
	VERTICAL SMT With Pegs								
	HORIZONTAL SMT								

All dimensions in mm.

M22 Connectors

2mm (.079") PITCH

Female Vertical PC Tail

- Twin beam phosphor bronze contacts.
- Suitable for use with mating M22 male pin headers, with 0.5mm square pins.
- For polarising key use **order code M22-0340000**.

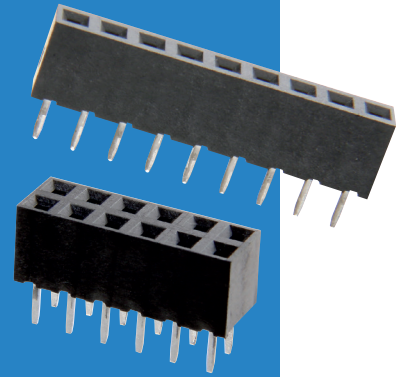

SINGLE ROW

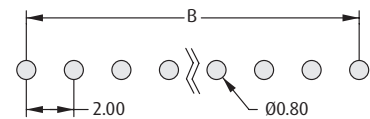
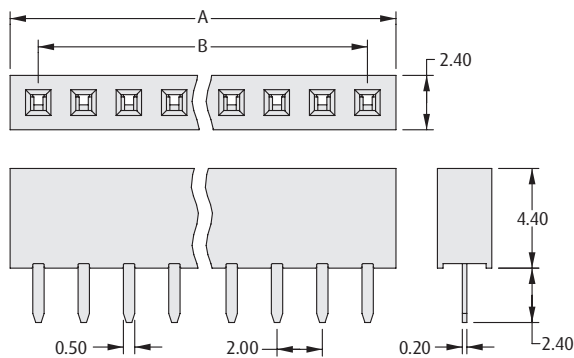

Recommended PC Board Pattern

CALCULATION

A	$B + 2.5$
B	$2 \times (\text{No. of contacts per row} - 1)$

DOUBLE ROW

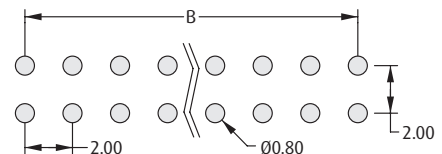
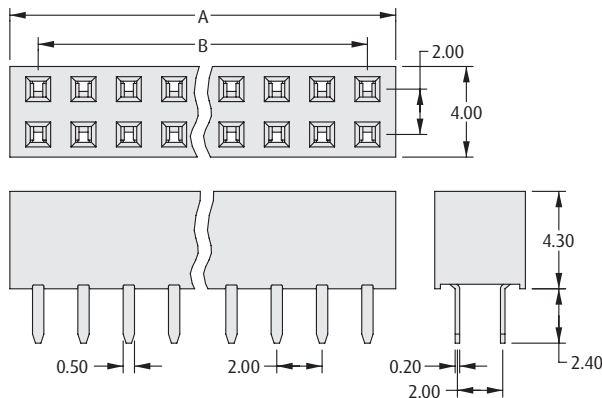

Recommended PC Board Pattern

HOW TO ORDER

M22 - 71 X XX XX

SERIES CODE

NO. OF ROWS

3	Single Row
4	Double Row

FINISH

42	Gold + Tin
-----------	------------

NO. OF CONTACTS PER ROW

03 to 20, 25	Single Row
03 to 25	Double Row

All dimensions in mm.

M22 Connectors

2mm (.079") PITCH

Female Vertical Surface Mount, Dual Entry

- ❖ Dual entry sockets - can be used as either a top entry or bottom entry configuration.
- ❖ The low profile socket has locating pegs, to assist with correct positioning and minimised movement during soldering.
- ❖ Twin beam contact for cost-effective reliability.
- ❖ Contact technical@harwin.com for Tape and Reel options.

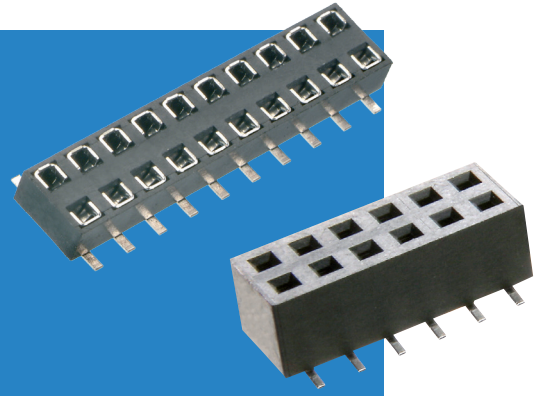

4.30mm HIGH

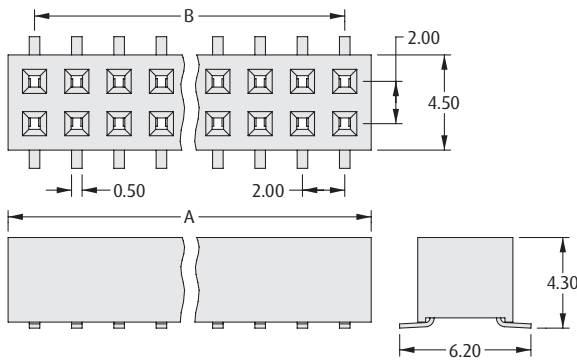

CALCULATION

A	$B + 2.5$
B	$2 \times (\text{No. of contacts per row} - 1)$

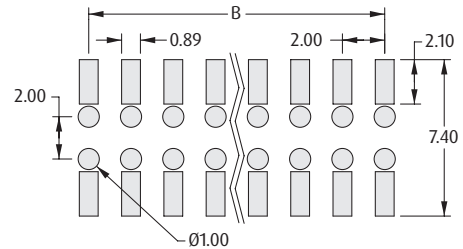

Recommended PC Board Pattern

2.10mm HIGH

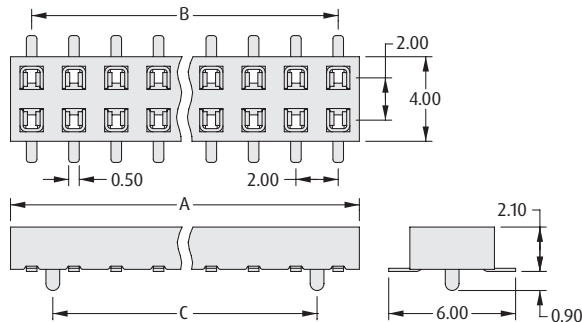

CALCULATION

A	$2 \times \text{No. of contacts per row}$
B	$2 \times (\text{No. of contacts per row} - 1)$
C	$B - 2$

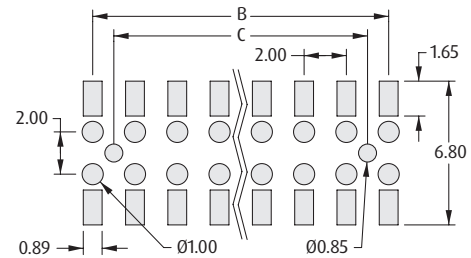

Recommended PC Board Pattern

HOW TO ORDER

M22 - 63 X XX XX

SERIES CODE

TYPE

4	4.30mm high
6	2.10mm high

FINISH

42	Gold + Tin
46	Tin (2.10mm high only)

NO. OF CONTACTS PER ROW

03 to 20	4.30mm high
02 to 20	2.10mm high

All dimensions in mm.

M22 Connectors

Female Horizontal Surface Mount

- Rear tail configuration, to allow mounting right up to the edge of the PCB.
- Supplied in Tape and Reel packaging as standard for use in automated assembly systems.

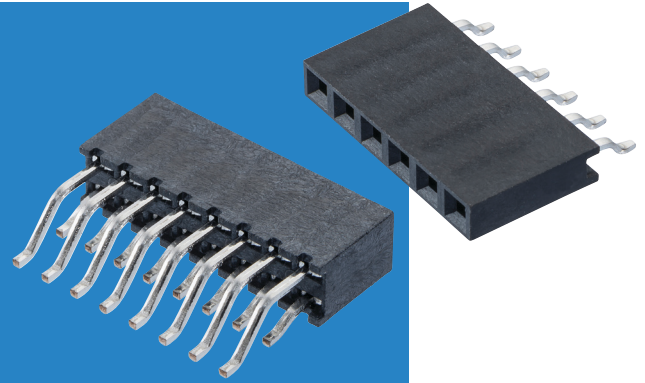

2mm (.079") PITCH

SINGLE ROW	CALCULATION	DOUBLE ROW	CALCULATION								
	<table border="1"> <tr> <td style="background-color: #0056b3; color: white;">A</td> <td>$B + 2.3$</td> </tr> <tr> <td style="background-color: #0056b3; color: white;">B</td> <td>$2 \times (\text{No. of contacts per row} - 1)$</td> </tr> </table>	A	$B + 2.3$	B	$2 \times (\text{No. of contacts per row} - 1)$		<table border="1"> <tr> <td style="background-color: #0056b3; color: white;">A</td> <td>$B + 2.3$</td> </tr> <tr> <td style="background-color: #0056b3; color: white;">B</td> <td>$2 \times (\text{No. of contacts per row} - 1)$</td> </tr> </table>	A	$B + 2.3$	B	$2 \times (\text{No. of contacts per row} - 1)$
A	$B + 2.3$										
B	$2 \times (\text{No. of contacts per row} - 1)$										
A	$B + 2.3$										
B	$2 \times (\text{No. of contacts per row} - 1)$										
<p style="text-align: center;">Recommended PC Board Pattern</p>		<p style="text-align: center;">Recommended PC Board Pattern</p>									

HOW TO ORDER

M22 - 65 X XX XX R

SERIES CODE

TYPE

4	Single Row
5	Double Row

PACKAGING

R Tape & Reeled

FINISH

42 Gold + Tin

NO. OF CONTACTS PER ROW

02 to 06, 08, 10

All dimensions in mm.

M22 Connectors

Female Crimp Housings

- Female crimp housing - contacts are ordered separately (shown on following page).
- For polarising key use **order code M22-0340000**.

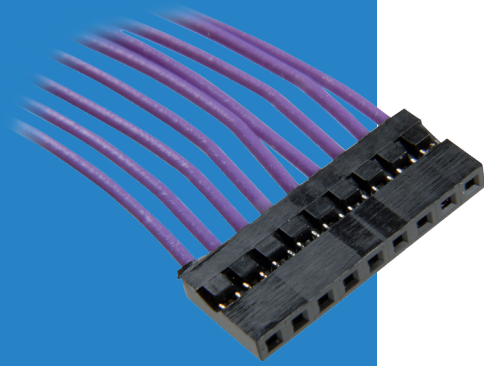

2mm (.079") PITCH

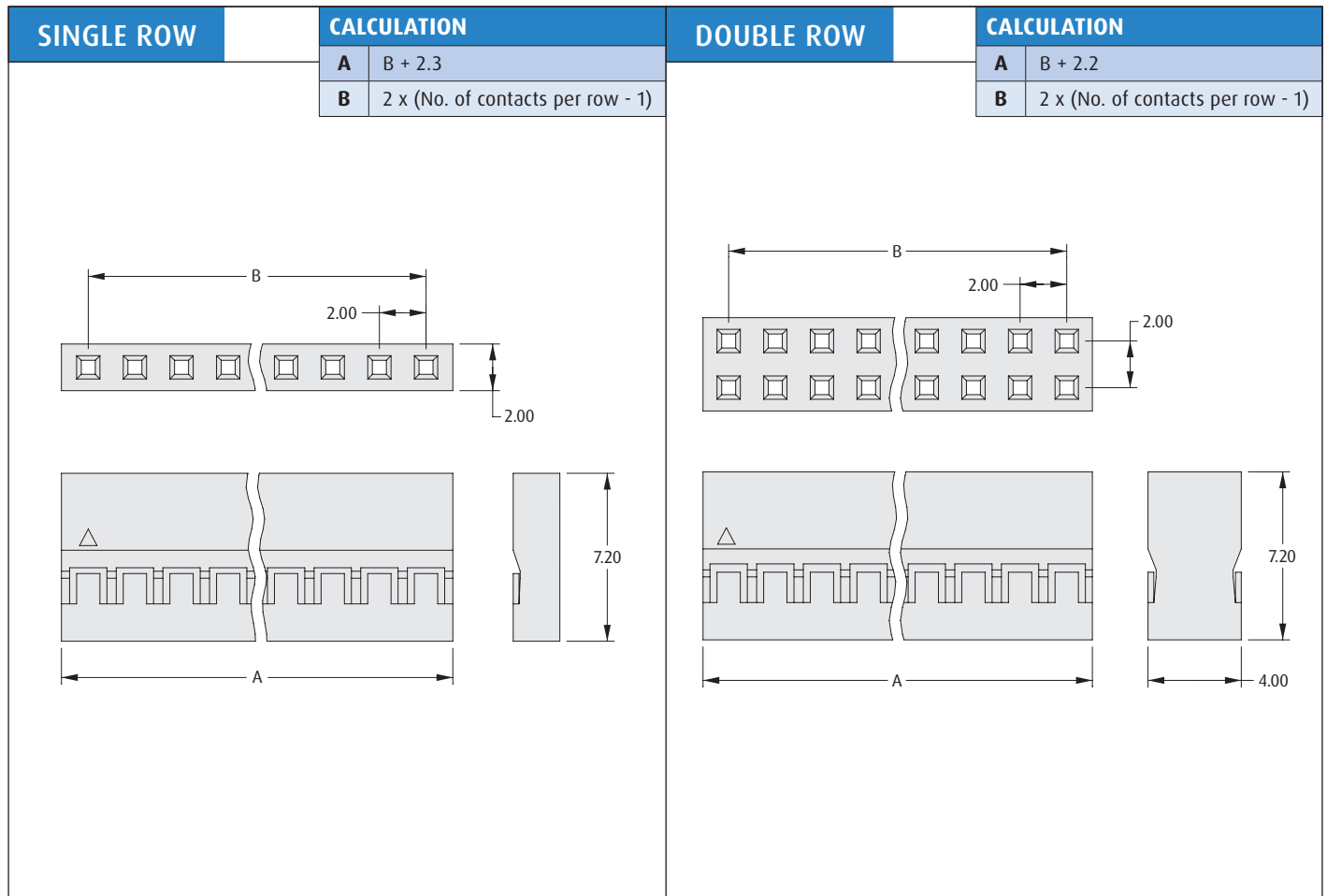

HOW TO ORDER

M22 - 30 X XX 00

SERIES CODE

TYPE

1	Single Row
2	Double Row

NO. OF CONTACTS PER ROW

02 to 20

All dimensions in mm.

M22 Connectors

Female Crimp Contacts

- ❖ Loose or reeled contacts.
- ❖ Open crimp design, ideal for automation.
- ❖ Use with female crimp housings shown on previous page.
- ❖ Suitable for connection with male pin headers with a mating length of 4.00mm or longer.

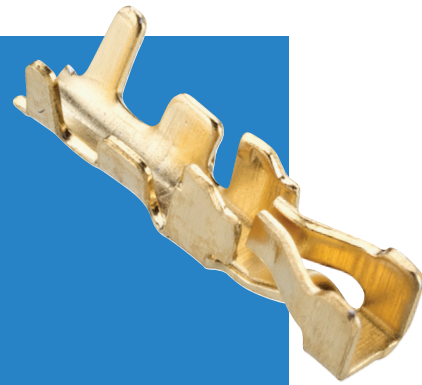

2mm (.079") PITCH

CONTACTS

Reeled (continuous strip)

- ❖ Order code is for one reel of 10,000 contacts.

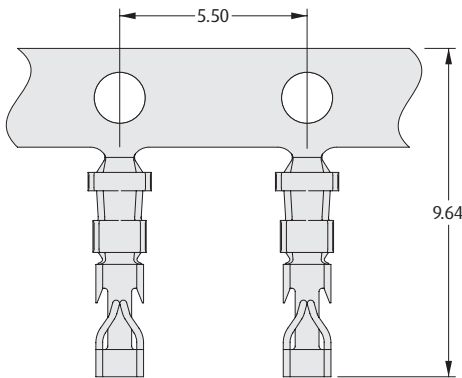

Loose (cropped)

- ❖ Order code is for one pack of 100 contacts.

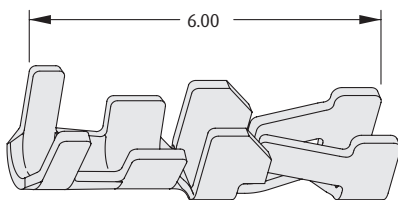

HAND CRIMP TOOL

- ❖ Instruction sheet is available at www.harwin.com/instructions.
- ❖ For use with loose contacts.



ORDER CODE

Z22-020

WIRE STRIPPING DETAILS

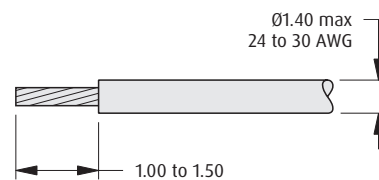

HOW TO ORDER

M22 - 30 X 00 XX

SERIES CODE

TYPE	
4	Reeled Contacts
5	Loose Contacts

FINISH

42	Gold
46	Tin

All dimensions in mm.

M22 Connectors

Jumper Sockets, Polarising Key

- Can be fitted and removed by hand.
- Used with male pin headers, Jumper Sockets give an alternative on-board programming method to DIP switches.
- Jumper Sockets have an open top for use with test probes.

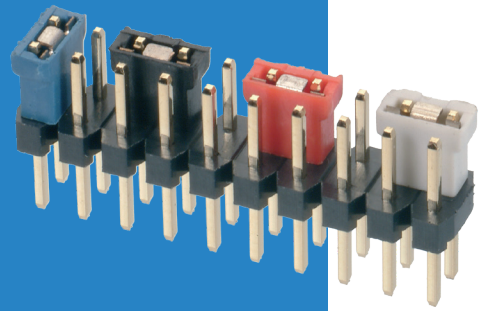

2mm (.079") PITCH

JUMPER SOCKET

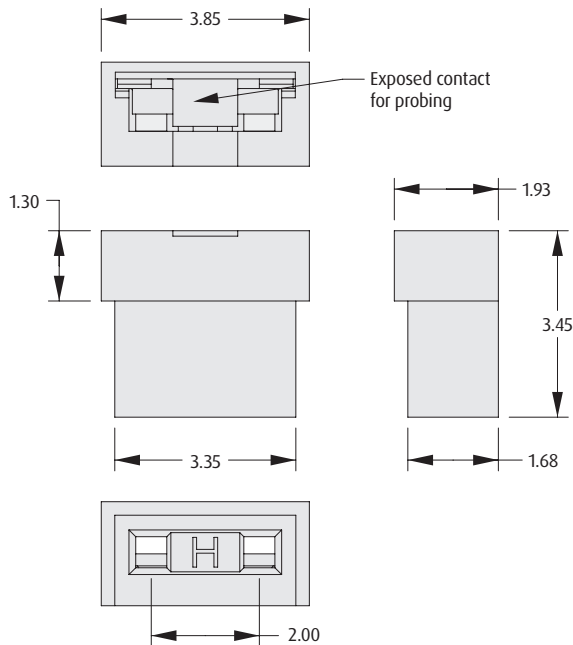

POLARISING KEY

- For use with Female Vertical PC Tail connectors, M22-713 and M22-714 series.
- For use with Female Cable Housings, M22-301 and M22-302 series.

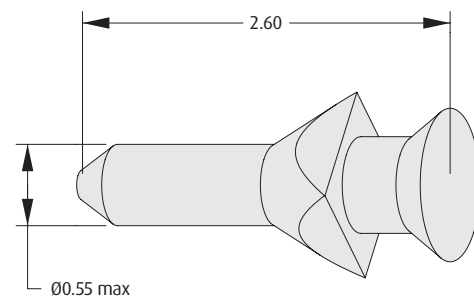

HOW TO ORDER

M22 - 19 X 00 XX

SERIES CODE

COLOUR

0	Black
1	Blue
2	Red
3	Grey

FINISH

05	Gold
46	Tin

ORDER CODE

M22-0340000

All dimensions in mm.

M22 Connectors

Male Vertical PC Tail

- ❖ Suitable for use with female PCB connectors and jumper sockets.
- ❖ 4.2mm mating pin length recommended for use with female cable connections.
- ❖ Pin headers can be cut into smaller sizes.
- ❖ Also available with variable dimensions.

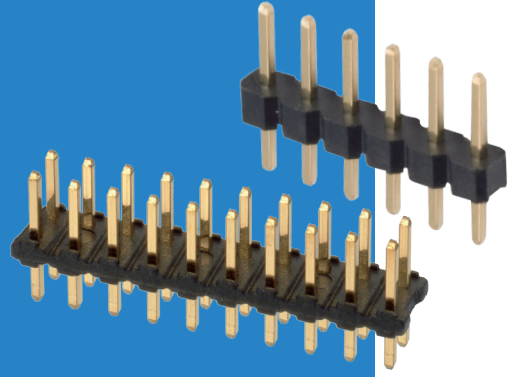

2mm (.079") PITCH

SINGLE ROW

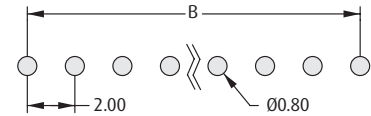
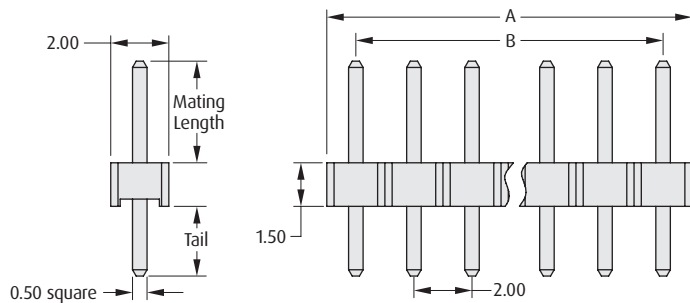

Recommended PC Board Pattern

CALCULATION

- A** 2 x No. of contacts per row
- B** 2 x (No. of contacts per row - 1)

DOUBLE ROW

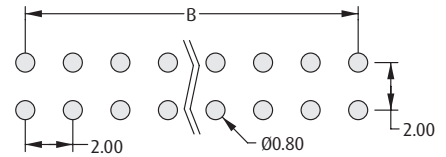
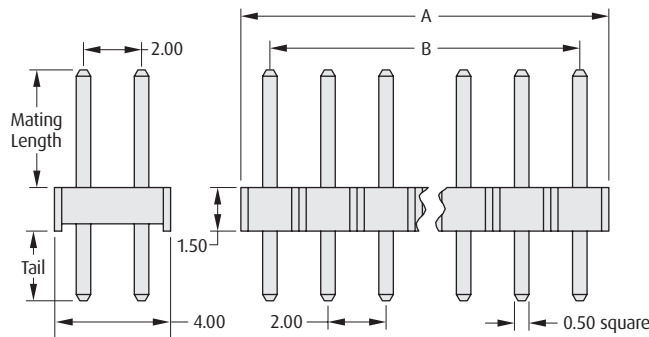

Recommended PC Board Pattern

HOW TO ORDER

M22 - 2XX XX XX

SERIES CODE

FINISH

05	Gold
46	Tin

TYPE

SINGLE ROW	DOUBLE ROW	MATING LENGTH	TAIL
201	202	3.50mm	3.40mm
251	252	3.50mm	2.30mm
271	272	4.20mm	2.30mm

NO. OF CONTACTS PER ROW

02 to 25, 50	M22-201, M22-202
02 to 20, 25, 40, 50	M22-251
02 to 20, 25, 40	M22-252
02 to 20	M22-271, M22-272

All dimensions in mm.

M22 Connectors

Male Horizontal PC Tail

- Suitable for use with female PCB connectors and jumper sockets.
- 4.2mm mating pin length recommended for use with female cable connectors.
- Pin headers can be cut into smaller sizes.
- Also available with variable dimensions.

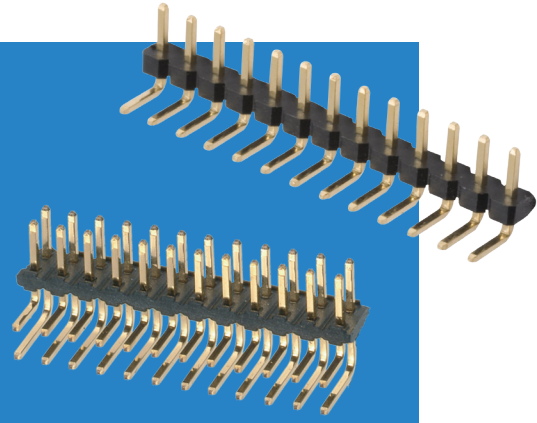

SINGLE ROW

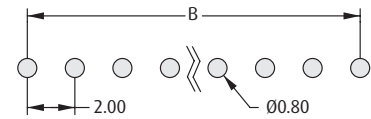
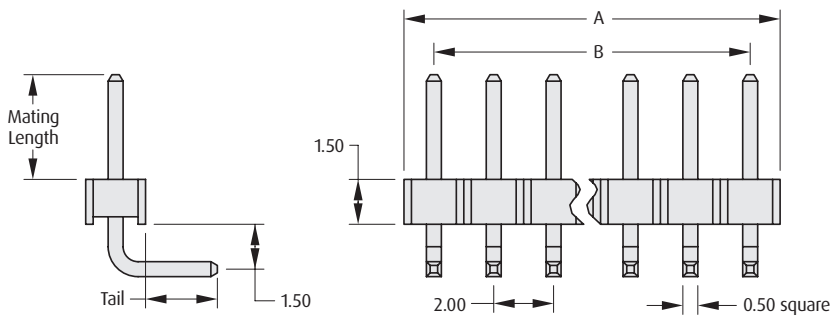

Recommended PC Board Pattern

CALCULATION

A	2 x No. of contacts per row
B	2 x (No. of contacts per row - 1)

DOUBLE ROW

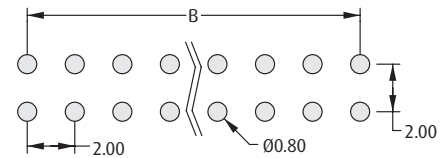
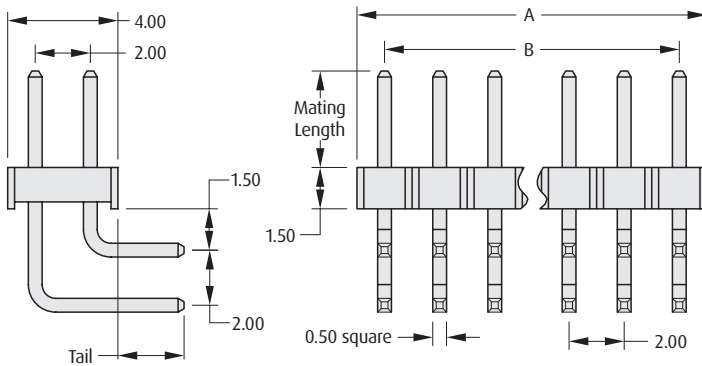

Recommended PC Board Pattern

HOW TO ORDER

M22 - 2XX XX XX

SERIES CODE

FINISH

05	Gold
46	Tin

TYPE

SINGLE ROW	DOUBLE ROW	MATING LENGTH	TAIL
203	204	3.50mm	3.00mm
253	254	3.50mm	2.40mm
273	274	4.20mm	2.40mm

NO. OF CONTACTS PER ROW

02 to 25, 50	M22-203, M22-204
02 to 20	Others

All dimensions in mm.

M22 Connectors

Male Vertical Surface Mount

- ❖ Suitable for use with female PCB connectors and jumper sockets.
- ❖ 4.2mm mating pin length recommended for use with female cable connectors.
- ❖ Pin headers can be cut into smaller sizes.
- ❖ Also available with variable dimensions.
- ❖ Tape and Reel option supplied fitted with Pick and Place cap, contact technical@harwin.com for availability.

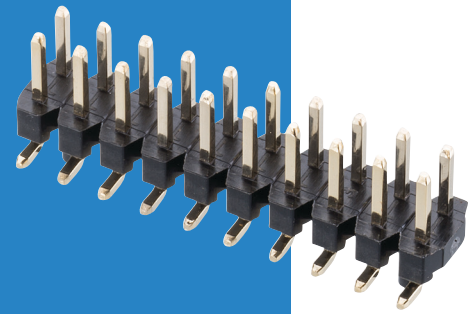

2mm (.079") PITCH

DOUBLE ROW

CALCULATION

A	2 x No. of contacts per row
B	2 x (No. of contacts per row - 1)

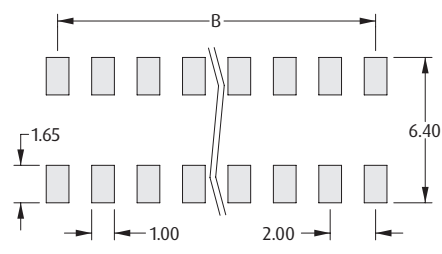
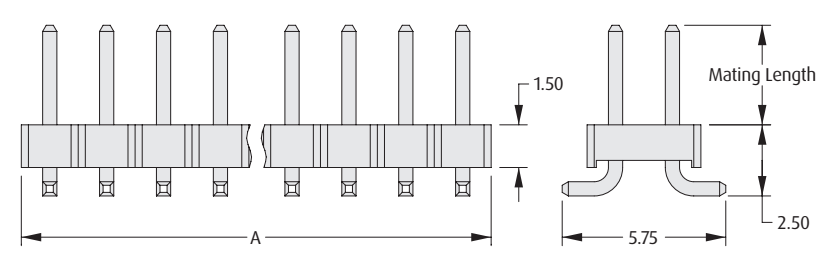
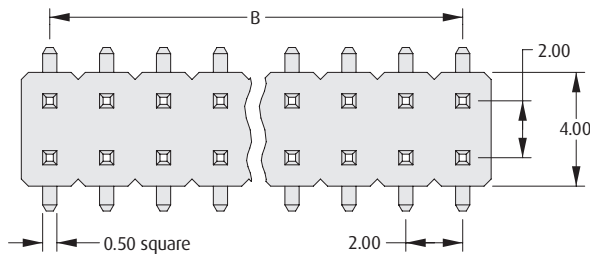

Recommended PC Board Pattern

HOW TO ORDER

M22 - 5 X 2 XX XX X

SERIES CODE

TYPE

3	3.50mm Mating Length
5	4.20mm Mating Length

NO. OF CONTACTS PER ROW

02 to 25	3.50mm Mating Length
02 to 20	4.20mm Mating Length

PACKAGING

Blank	Loose
P	Pick and Place cap, tube
R	Tape & Reeled

FINISH

05	Gold
46	Tin

All dimensions in mm.

M22 Connectors

Male Vertical Surface Mount

- ❖ Suitable for use with female PCB connectors and jumper sockets.
- ❖ Supplied with location pegs for additional placement accuracy.
- ❖ Tape and Reel option supplied fitted with Pick and Place cap.

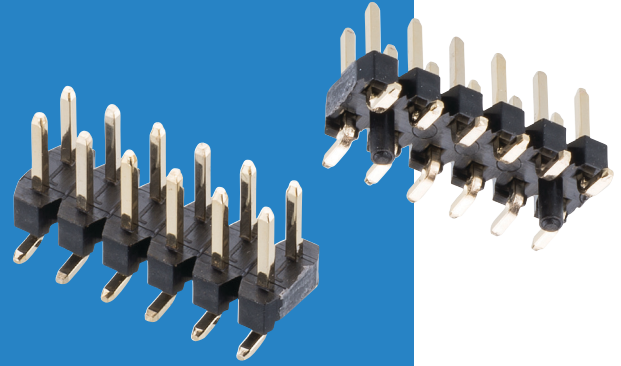

2mm (.079") PITCH

DOUBLE ROW

CALCULATION

A	2 x No. of contacts per row
B	2 x (No. of contacts per row - 1)
C	B - 2

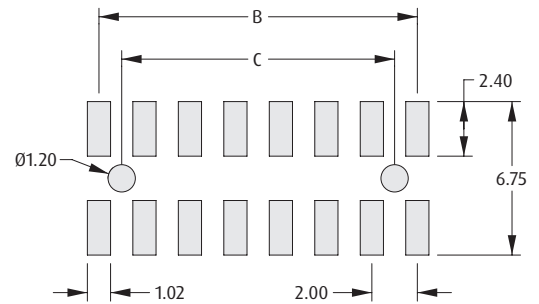
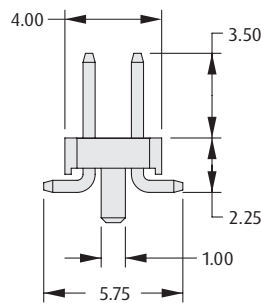
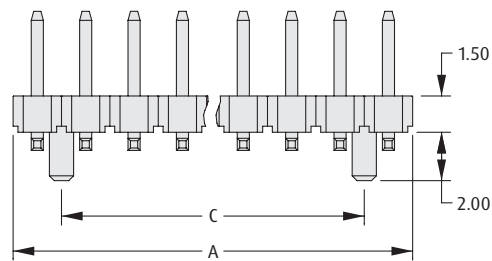
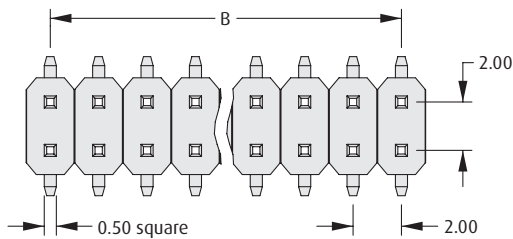

Recommended PC Board Pattern

HOW TO ORDER

M22 - 530 XX 05 X

SERIES CODE

NO. OF CONTACTS PER ROW

02 to 06, 10	Loose
02, 03, 05	Tape & Reeled

PACKAGING

Blank	Loose
R	Tape & Reeled

FINISH

05	Gold
-----------	------

All dimensions in mm.

M22 Connectors

Male Horizontal Surface Mount

- Suitable for use with female PCB connectors and jumper sockets.
- 4.2mm mating pin length recommended for use with female cable connectors.
- Single row pin headers can be cut into smaller sizes.
- Locating pegs on double row, to assist with correct positioning and minimised movement during soldering.
- Contact technical@harwin.com for Tape and Reel options.

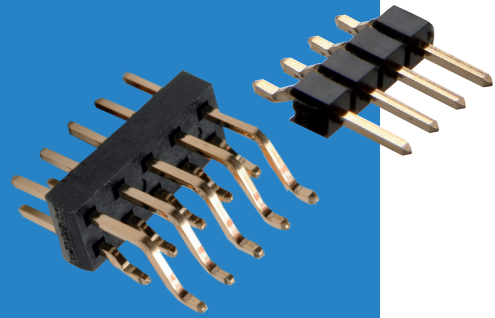

2mm (.079") PITCH

SINGLE ROW

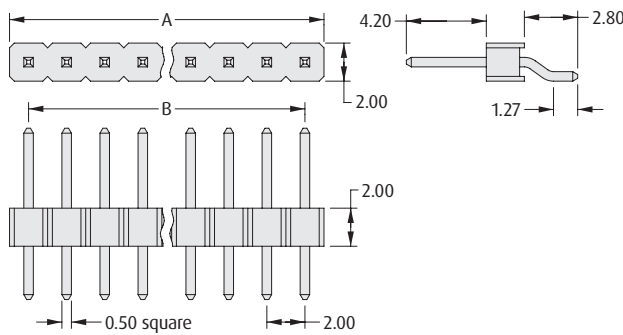

CALCULATION

A	2 x No. of contacts per row
B	2 x (No. of contacts per row - 1)

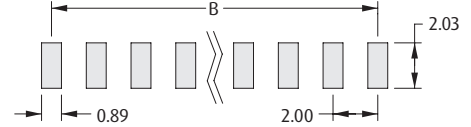

Recommended PC Board Pattern

DOUBLE ROW

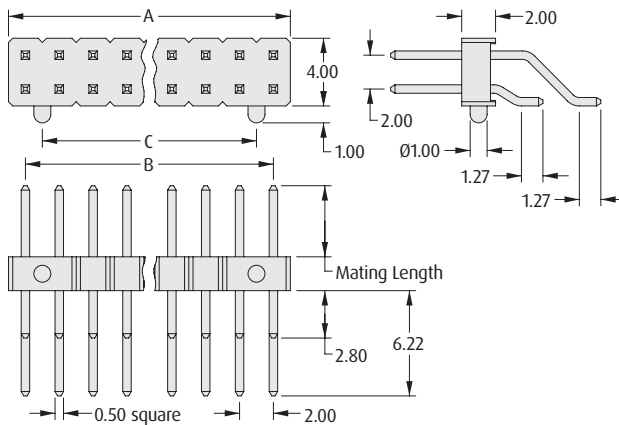

CALCULATION

A	2 x No. of contacts per row
B	2 x (No. of contacts per row - 1)
C	B - 2

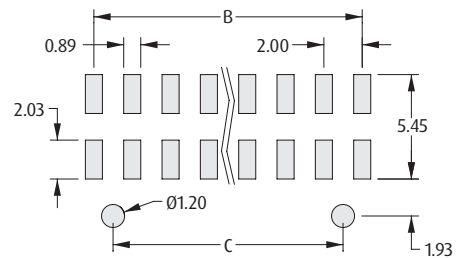

Recommended PC Board Pattern

HOW TO ORDER

M22 - 5 X 3 XX 05

SERIES CODE

FINISH

05 Gold

TYPE

3	Single Row
4	Double Row, 3.2mm Mating Length
6	Double Row, 4.2mm Mating Length

NO. OF CONTACTS PER ROW

02 to 15	M22-533
03 to 15, 20	M22-543
03 to 20	M22-563

All dimensions in mm.

M22 Connectors

Pin Header Variants

- ❖ If you are unable to specify the connector you require from our standard range of M22 connectors, use the order code below to create an application-specific connector.
- ❖ Contact technical@harwin.com for further information, or search online for M22-XXX.
- ❖ Suitable for use with female connectors shown on previous pages.



2mm (.079") PITCH

TERMINATION STYLES

Vertical PC Tail

- ❖ Pin section is 0.50mm square.
- ❖ PCB mounting hole is $\varnothing 0.80\text{mm}$.

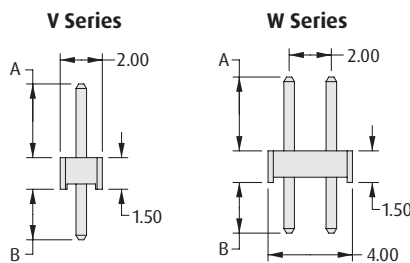

Horizontal PC Tail

- ❖ Pin section is 0.50mm square.
- ❖ PCB mounting hole is $\varnothing 0.80\text{mm}$.
- ❖ Maximum B dimension is 6.00mm.

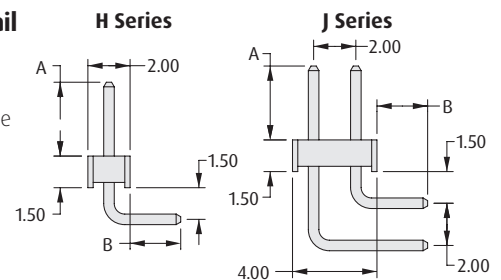

Extended PC Tail

- ❖ Pin section is 0.50mm square.
- ❖ PCB mounting hole is $\varnothing 0.80\text{mm}$.

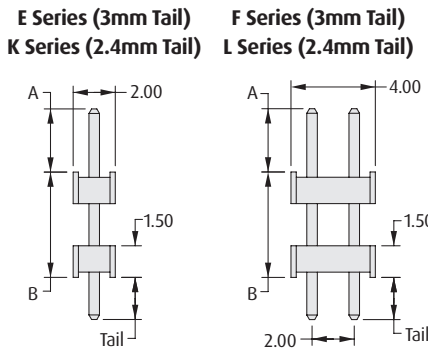

Vertical SMT Extended SMT

- ❖ Pin section is 0.50mm square.
- ❖ For PCB pad layout see standard Male SMT pin header.
- ❖ B dimension is 000 on S series.

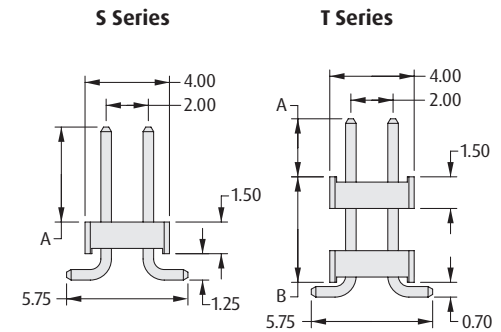

HOW TO ORDER

M22 - XXX XXX X XX XX

FINISH

05	Gold
46	Tin

SERIES CODE

DIMENSION A

Example: 7.8mm = 078

DIMENSION B

Example: 5.0mm = 050

NO. OF CONTACTS PER ROW

02 to 50

SINGLE ROW	DOUBLE ROW	
V	W	Vertical
H	J	Horizontal
E	F	Extended
K	L	Extended (2.4mm Tail)
-	S	Surface Mount
-	T	Extended Surface Mount

All dimensions in mm.