

General Description

- The AON7408 uses advanced trench technology and design to provide excellent $R_{DS(ON)}$ with low gate charge. This device is suitable for use in general purpose applications.

- RoHS and Halogen-Free Compliant

Product Summary

V_{DS}	30V
I_D (at $V_{GS}=10V$)	18A
$R_{DS(ON)}$ (at $V_{GS}=10V$)	< 20m Ω
$R_{DS(ON)}$ (at $V_{GS}=4.5V$)	< 32m Ω

100% UIS Tested
 100% R_g Tested

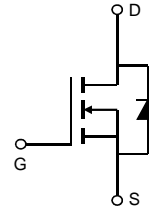
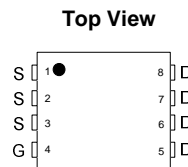
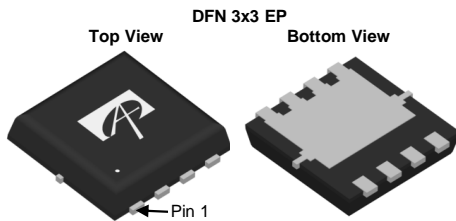

Absolute Maximum Ratings $T_A=25^\circ\text{C}$ unless otherwise noted

Parameter	Symbol	Maximum	Units
Drain-Source Voltage	V_{DS}	30	V
Gate-Source Voltage	V_{GS}	± 20	V
Continuous Drain Current ^B	I_D	$T_C=25^\circ\text{C}$	18
		$T_C=100^\circ\text{C}$	11.5
Pulsed Drain Current ^C	I_{DM}	64	A
Continuous Drain Current ^A	I_{DSM}	$T_A=25^\circ\text{C}$	10
		$T_A=70^\circ\text{C}$	8
Power Dissipation ^B	P_D	$T_C=25^\circ\text{C}$	11
		$T_C=100^\circ\text{C}$	4.5
Power Dissipation ^A	P_{DSM}	$T_A=25^\circ\text{C}$	3.1
		$T_A=70^\circ\text{C}$	2
Junction and Storage Temperature Range	T_J, T_{STG}	-55 to 150	$^\circ\text{C}$

Thermal Characteristics

Parameter	Symbol	Typ	Max	Units
Maximum Junction-to-Ambient ^A $t \leq 10s$	$R_{\theta JA}$	25	40	$^\circ\text{C/W}$
Maximum Junction-to-Ambient ^A Steady-State		62	75	$^\circ\text{C/W}$
Maximum Junction-to-Case ^B Steady-State	$R_{\theta JC}$	8.8	11	$^\circ\text{C/W}$

Electrical Characteristics (T_J=25°C unless otherwise noted)

Symbol	Parameter	Conditions	Min	Typ	Max	Units
STATIC PARAMETERS						
BV _{DSS}	Drain-Source Breakdown Voltage	I _D =250μA, V _{GS} =0V	30			V
I _{DSS}	Zero Gate Voltage Drain Current	V _{DS} =30V, V _{GS} =0V T _J =55°C			1 5	μA
I _{GSS}	Gate-Body leakage current	V _{DS} =0V, V _{GS} =±20V			±100	nA
V _{GS(th)}	Gate Threshold Voltage	V _{DS} =V _{GS} , I _D =250μA	1.5	2.1	2.6	V
I _{D(ON)}	On state drain current	V _{GS} =10V, V _{DS} =5V	64			A
R _{DS(ON)}	Static Drain-Source On-Resistance	V _{GS} =10V, I _D =10A T _J =125°C		15.3	20	mΩ
		V _{GS} =4.5V, I _D =5A		22.7	32	
g _{FS}	Forward Transconductance	V _{DS} =5V, I _D =10A		17		S
V _{SD}	Diode Forward Voltage	I _S =1A, V _{GS} =0V		0.75	1	V
I _S	Maximum Body-Diode Continuous Current				12	A
DYNAMIC PARAMETERS						
C _{iss}	Input Capacitance	V _{GS} =0V, V _{DS} =15V, f=1MHz		373	448	pF
C _{oss}	Output Capacitance			67		pF
C _{riss}	Reverse Transfer Capacitance			41		pF
R _g	Gate resistance	V _{GS} =0V, V _{DS} =0V, f=1MHz	0.6	1.8	2.8	Ω
SWITCHING PARAMETERS						
Q _g	Total Gate Charge	V _{GS} =4.5V, V _{DS} =15V, I _D =10A		7.1	8.6	nC
Q _{gs}	Gate Source Charge			1.2		nC
Q _{gd}	Gate Drain Charge			1.6		nC
t _{D(on)}	Turn-On DelayTime	V _{GS} =10V, V _{DS} =15V, R _L =1.5Ω, R _{GEN} =3Ω		4.3		ns
t _r	Turn-On Rise Time			2.8		ns
t _{D(off)}	Turn-Off DelayTime			15.8		ns
t _f	Turn-Off Fall Time			3		ns
t _{rr}	Body Diode Reverse Recovery Time	I _F =10A, dI/dt=100A/μs		10.5	12.6	ns
Q _{rr}	Body Diode Reverse Recovery Charge	I _F =10A, dI/dt=100A/μs		4.5		nC

A: The value of R_{θJA} is measured with the device in a still air environment with T_A=25° C. The power dissipation P_D and current rating I_{DSM} are based on T_{J(MAX)}=150° C, using t ≤ 10s junction-to-ambient thermal resistance.

B: The power dissipation P_D is based on T_{J(MAX)}=150° C, using junction-to-case thermal resistance, and is more useful in setting the upper dissipation limit for cases where additional heatsinking is used.

C: Repetitive rating, pulse width limited by junction temperature T_{J(MAX)}=150° C.

D: The R_{θJA} is the sum of the thermal impedance from junction to case R_{θJC} and case to ambient.

E: The static characteristics in Figures 1 to 6 are obtained using <300 μs pulses, duty cycle 0.5% max.

F: These curves are based on the junction-to-case thermal impedance which is measured with the device mounted to a large heatsink, assuming a maximum junction temperature of T_{J(MAX)}=150° C. The SOA curve provides a single pulse rating.

G: These tests are performed with the device mounted on 1 in² FR-4 board with 2oz. Copper, in a still air environment with T_A=25° C.

H: The maximum current rating is limited by bond-wires.

THIS PRODUCT HAS BEEN DESIGNED AND QUALIFIED FOR THE CONSUMER MARKET. APPLICATIONS OR USES AS CRITICAL COMPONENTS IN LIFE SUPPORT DEVICES OR SYSTEMS ARE NOT AUTHORIZED. AOS DOES NOT ASSUME ANY LIABILITY ARISING OUT OF SUCH APPLICATIONS OR USES OF ITS PRODUCTS. AOS RESERVES THE RIGHT TO IMPROVE PRODUCT DESIGN, FUNCTIONS AND RELIABILITY WITHOUT NOTICE.

TYPICAL ELECTRICAL AND THERMAL CHARACTERISTICS

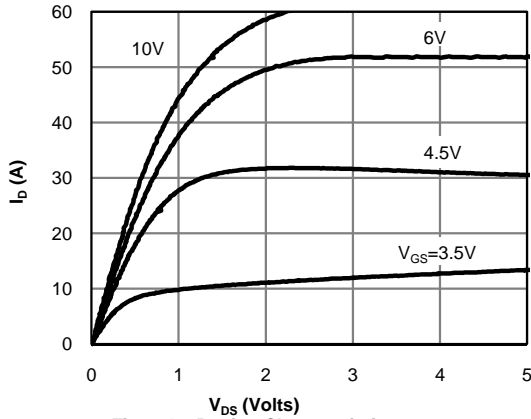

Fig 1: On-Region Characteristics

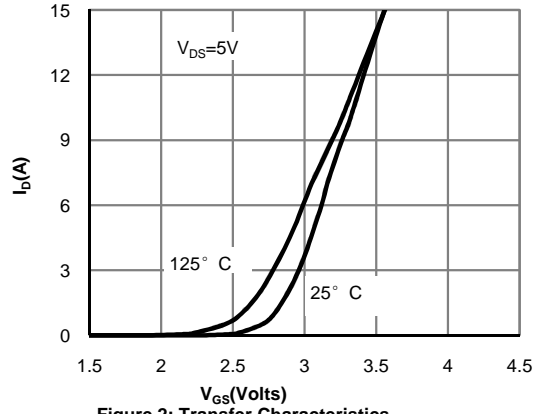

Figure 2: Transfer Characteristics

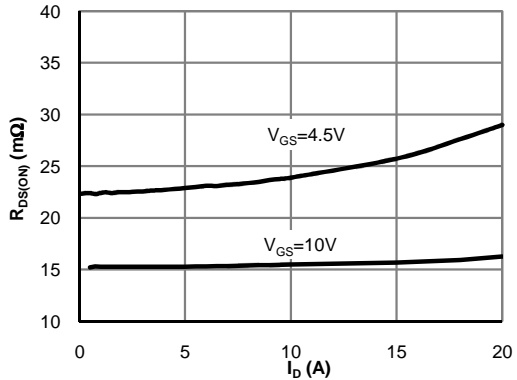

Figure 3: On-Resistance vs. Drain Current and Gate Voltage

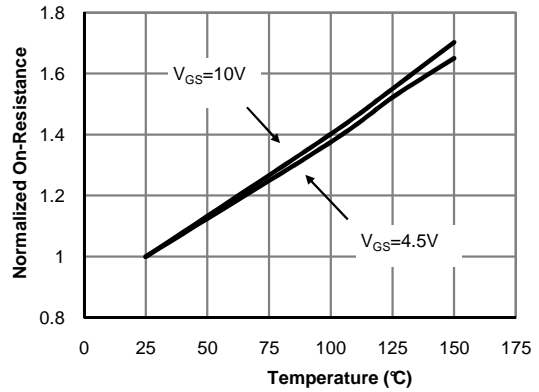

Figure 4: On-Resistance vs. Junction Temperature

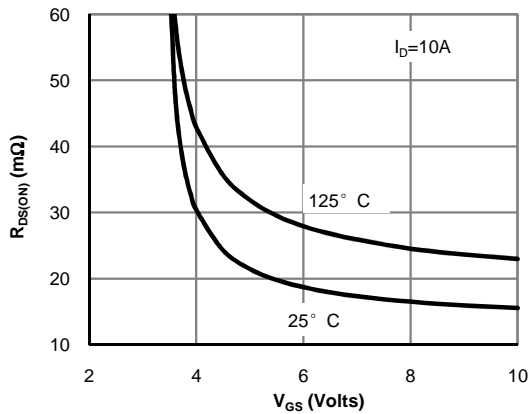

Figure 5: On-Resistance vs. Gate-Source Voltage

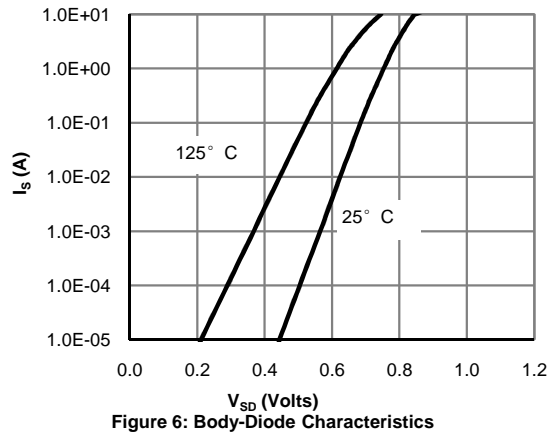

Figure 6: Body-Diode Characteristics

TYPICAL ELECTRICAL AND THERMAL CHARACTERISTICS

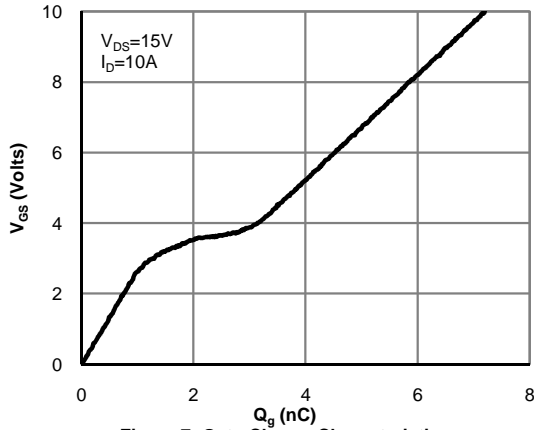

Figure 7: Gate-Charge Characteristics

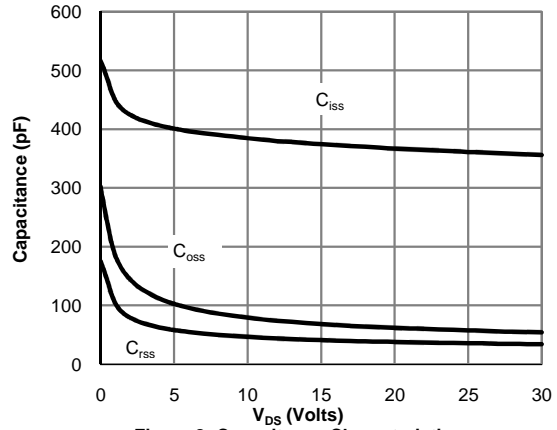

Figure 8: Capacitance Characteristics

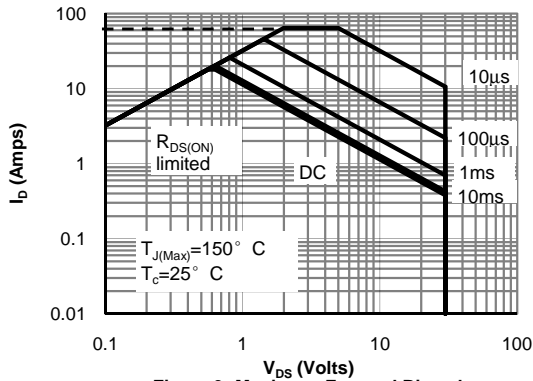

Figure 9: Maximum Forward Biased Safe Operating Area (Note H)

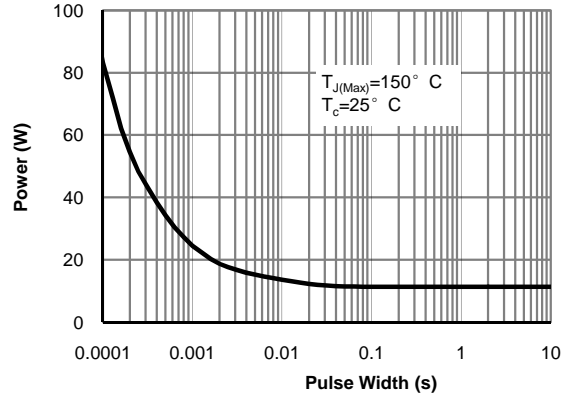

Figure 10: Single Pulse Power Rating Junction-to-C: (Note F)

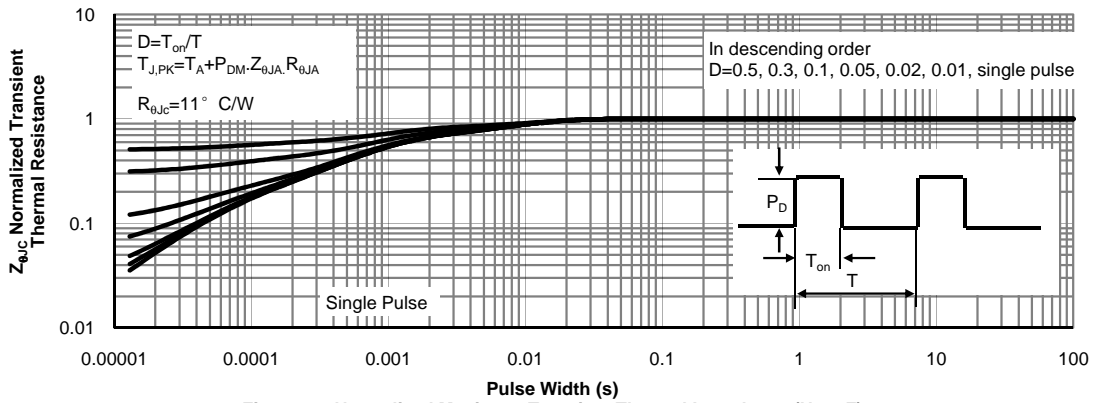

Figure 11: Normalized Maximum Transient Thermal Impedance (Note F)

TYPICAL ELECTRICAL AND THERMAL CHARACTERISTICS

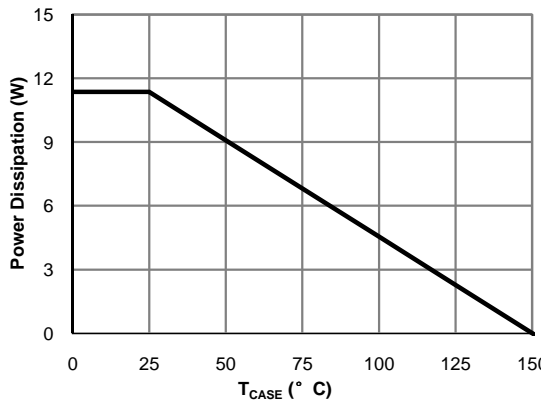

Figure 12: Power De-rating (Note F)

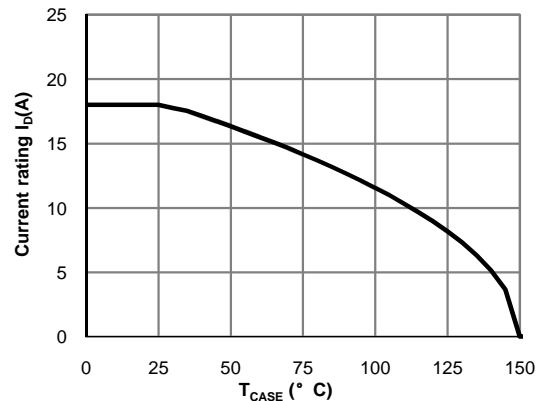

Figure 13: Current De-rating (Note F)

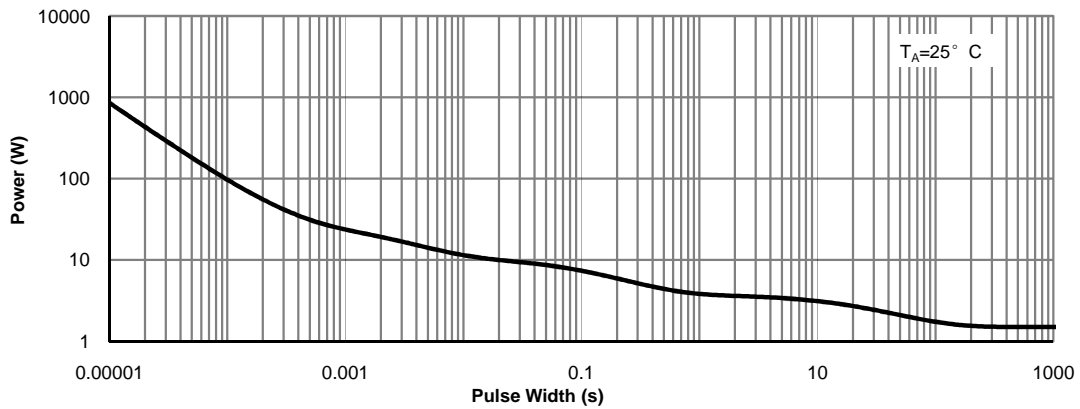

Figure 14: Single Pulse Power Rating Junction-to-Ambient (Note H)

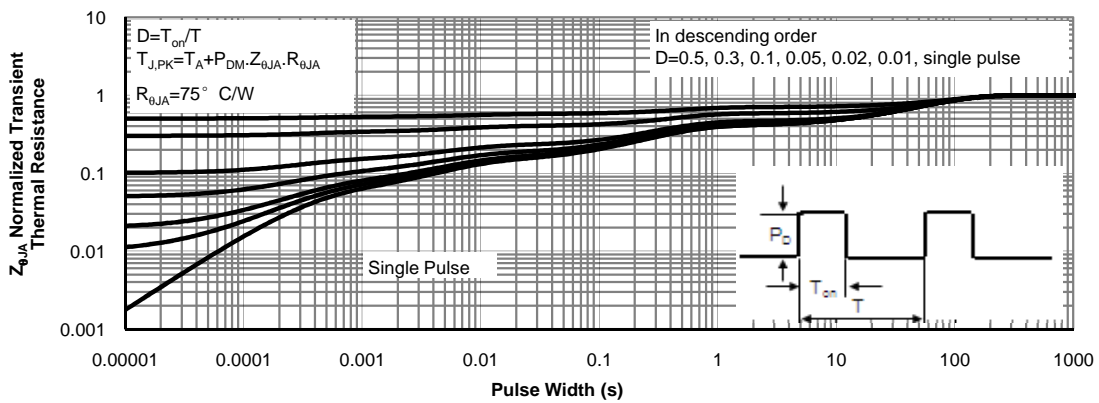
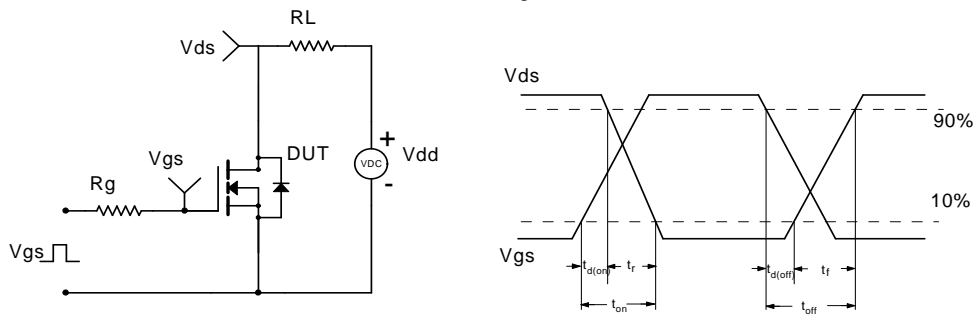

Figure 15: Normalized Maximum Transient Thermal Impedance (Note H)

Gate Charge Test Circuit & Waveform



Resistive Switching Test Circuit & Waveforms



Unclamped Inductive Switching (UIS) Test Circuit & Waveforms



Diode Recovery Test Circuit & Waveforms

