

Dual Common Source MOSFET Power Module

$V_{DSS} = 1200V$
 $R_{DSon} = 290m\Omega \text{ typ @ } T_j = 25^\circ C$
 $I_D = 34A \text{ @ } T_c = 25^\circ C$

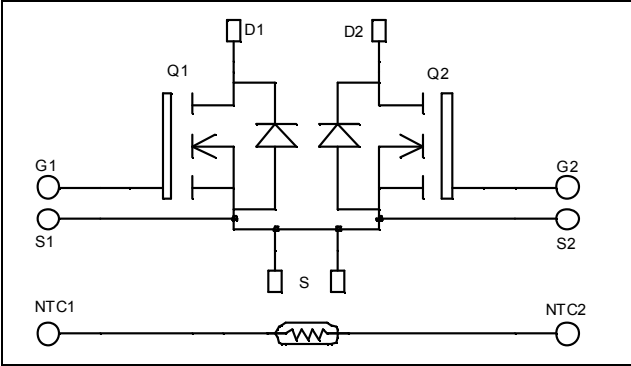

Application

- AC Switches
- Switched Mode Power Supplies
- Uninterruptible Power Supplies

Features

- Power MOS 7[®] MOSFETs
 - Low R_{DSon}
 - Low input and Miller capacitance
 - Low gate charge
 - Avalanche energy rated
 - Very rugged
- Kelvin source for easy drive
- Very low stray inductance
 - Symmetrical design
 - Lead frames for power connections
- Internal thermistor for temperature monitoring
- High level of integration

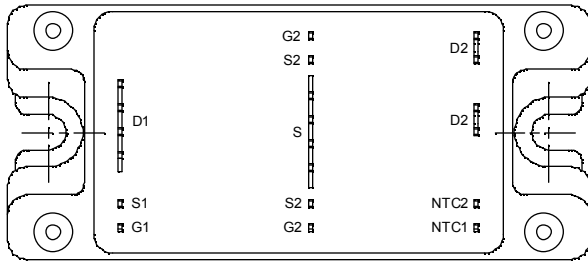

Benefits

- Outstanding performance at high frequency operation
- Direct mounting to heatsink (isolated package)
- Low junction to case thermal resistance
- Solderable terminals both for power and signal for easy PCB mounting
- Low profile
- RoHS Compliant

Absolute maximum ratings

Symbol	Parameter	Max ratings	Unit
V_{DSS}	Drain - Source Breakdown Voltage	1200	V
I_D	Continuous Drain Current	$T_c = 25^\circ C$	A
		$T_c = 80^\circ C$	
I_{DM}	Pulsed Drain current	136	
V_{GS}	Gate - Source Voltage	± 30	V
R_{DSon}	Drain - Source ON Resistance	348	m Ω
P_D	Maximum Power Dissipation	$T_c = 25^\circ C$	W
I_{AR}	Avalanche current (repetitive and non repetitive)	22	A
E_{AR}	Repetitive Avalanche Energy	50	mJ
E_{AS}	Single Pulse Avalanche Energy	3000	

CAUTION: These Devices are sensitive to Electrostatic Discharge. Proper Handling Procedures Should Be Followed. See application note APT0502 on www.microsemi.com

All ratings @ $T_j = 25^\circ\text{C}$ unless otherwise specified

Electrical Characteristics

Symbol	Characteristic	Test Conditions	Min	Typ	Max	Unit
I_{DSS}	Zero Gate Voltage Drain Current	$V_{GS} = 0\text{V}, V_{DS} = 1200\text{V}$			350	μA
		$V_{GS} = 0\text{V}, V_{DS} = 1000\text{V}$	$T_j = 25^\circ\text{C}$		1500	
$R_{DS(on)}$	Drain – Source on Resistance	$V_{GS} = 10\text{V}, I_D = 17\text{A}$		290	348	$\text{m}\Omega$
$V_{GS(th)}$	Gate Threshold Voltage	$V_{GS} = V_{DS}, I_D = 5\text{mA}$	3		5	V
I_{GSS}	Gate – Source Leakage Current	$V_{GS} = \pm 30\text{V}, V_{DS} = 0\text{V}$			± 150	nA

Dynamic Characteristics

Symbol	Characteristic	Test Conditions	Min	Typ	Max	Unit
C_{iss}	Input Capacitance	$V_{GS} = 0\text{V}$ $V_{DS} = 25\text{V}$ $f = 1\text{MHz}$		10.3		nF
C_{oss}	Output Capacitance			1.54		
C_{rss}	Reverse Transfer Capacitance			0.26		
Q_g	Total gate Charge	$V_{GS} = 10\text{V}$ $V_{Bus} = 600\text{V}$ $I_D = 34\text{A}$		374		nC
Q_{gs}	Gate – Source Charge			48		
Q_{gd}	Gate – Drain Charge			240		
$T_{d(on)}$	Turn-on Delay Time	Inductive switching @ 125°C $V_{GS} = 15\text{V}$ $V_{Bus} = 800\text{V}$ $I_D = 34\text{A}$ $R_G = 2.5\Omega$		20		ns
T_r	Rise Time			15		
$T_{d(off)}$	Turn-off Delay Time			160		
T_f	Fall Time			45		
E_{on}	Turn-on Switching Energy	Inductive switching @ 25°C $V_{GS} = 15\text{V}, V_{Bus} = 800\text{V}$ $I_D = 34\text{A}, R_G = 2.5\Omega$		1980		μJ
E_{off}	Turn-off Switching Energy			1371		
E_{on}	Turn-on Switching Energy	Inductive switching @ 125°C $V_{GS} = 15\text{V}, V_{Bus} = 800\text{V}$ $I_D = 34\text{A}, R_G = 2.5\Omega$		3131		μJ
E_{off}	Turn-off Switching Energy			1714		

Source - Drain diode ratings and characteristics

Symbol	Characteristic	Test Conditions	Min	Typ	Max	Unit
I_S	Continuous Source current (Body diode)	$T_c = 25^\circ\text{C}$			34	A
		$T_c = 80^\circ\text{C}$			25	
V_{SD}	Diode Forward Voltage	$V_{GS} = 0\text{V}, I_S = -34\text{A}$			1.3	V
dv/dt	Peak Diode Recovery ①				10	V/ns
t_{rr}	Reverse Recovery Time	$I_S = -34\text{A}; V_R = 600\text{V}$		1291		ns
Q_{rr}	Reverse Recovery Charge	$di/dt = 200\text{A}/\mu\text{s}$		58		μC

① dv/dt numbers reflect the limitations of the circuit rather than the device itself.

$$I_S \leq -34\text{A} \quad di/dt \leq 700\text{A}/\mu\text{s} \quad V_R \leq V_{DSS} \quad T_j \leq 150^\circ\text{C}$$

Thermal and package characteristics

Symbol	Characteristic	Min	Typ	Max	Unit	
R _{thJC}	Junction to Case Thermal Resistance			0.16	°C/W	
V _{ISOL}	RMS Isolation Voltage, any terminal to case t=1 min, I _{isol} <1mA, 50/60Hz	2500			V	
T _J	Operating junction temperature range	-40		150	°C	
T _{STG}	Storage Temperature Range	-40		125		
T _C	Operating Case Temperature	-40		100		
Torque	Mounting torque	To Heatsink	M5	2.5	4.7	N.m
Wt	Package Weight			160		g

Temperature sensor NTC (see application note APT0406 on www.microsemi.com for more information).

Symbol	Characteristic	Min	Typ	Max	Unit
R ₂₅	Resistance @ 25°C		50		kΩ
B _{25/85}	T ₂₅ = 298.15 K		3952		K

$$R_T = \frac{R_{25}}{\exp\left[B_{25/85}\left(\frac{1}{T_{25}} - \frac{1}{T}\right)\right]}$$

T: Thermistor temperature
 R_T: Thermistor value at T

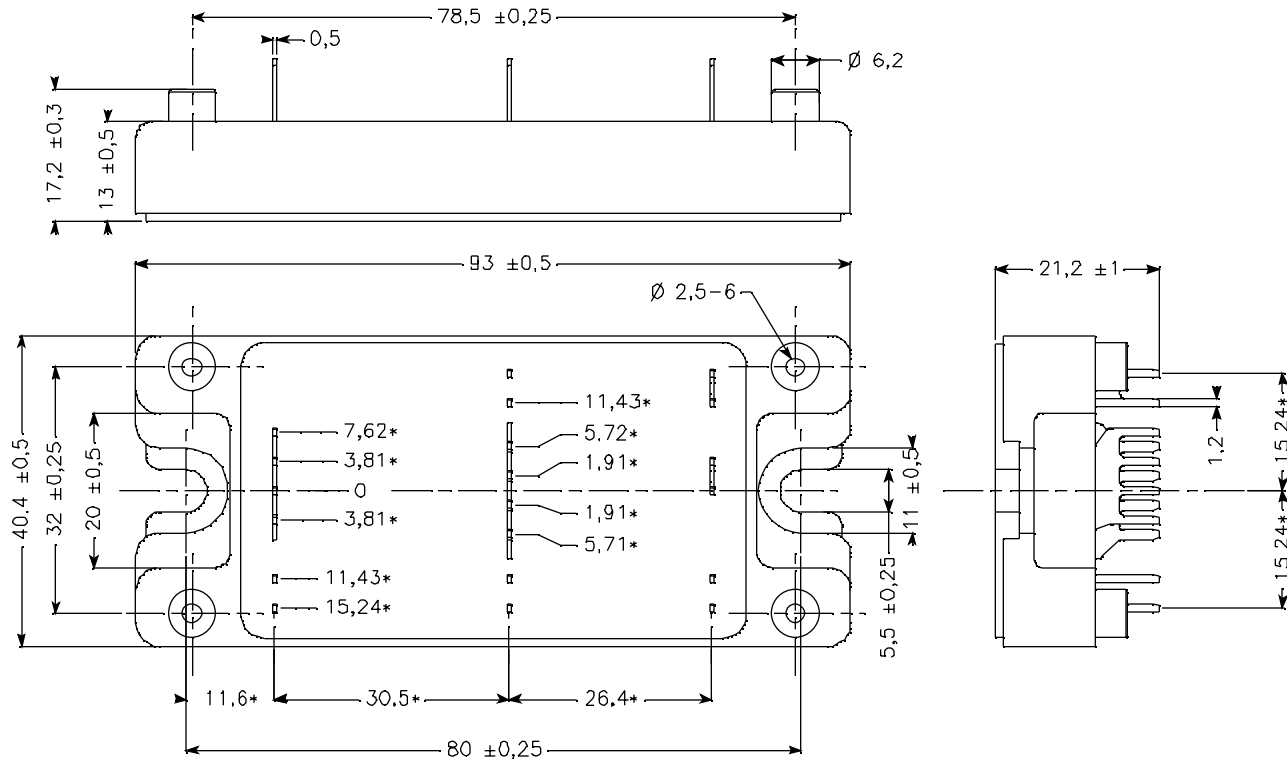
SP4 Package outline (dimensions in mm)

 ALL DIMENSIONS MARKED "*" ARE TOLERANCED AS: $\boxed{\oplus \ominus 0.1}$

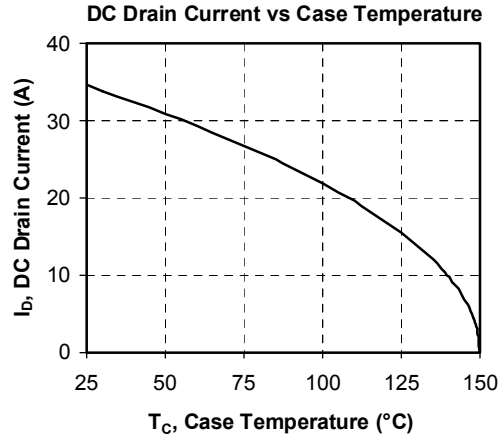
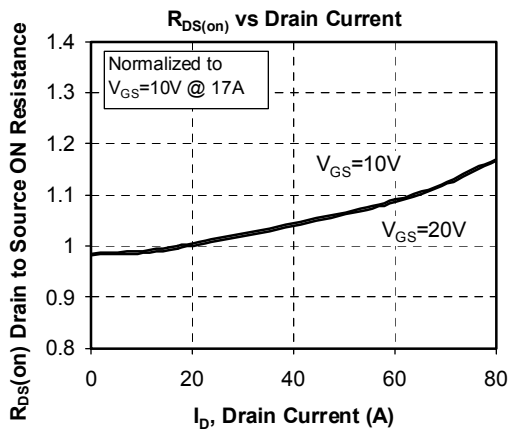
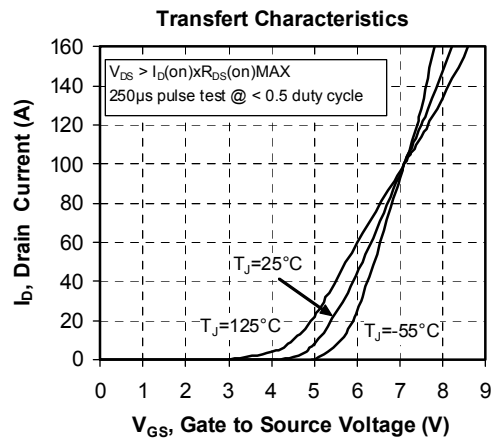
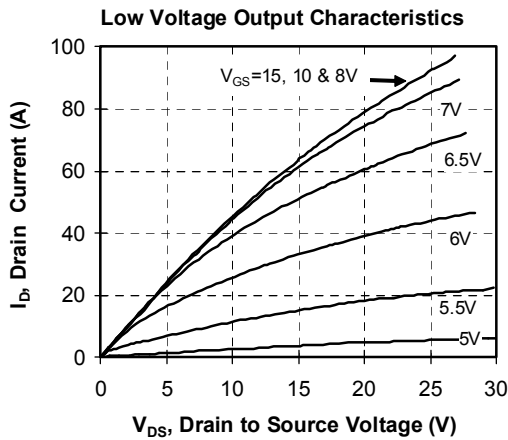
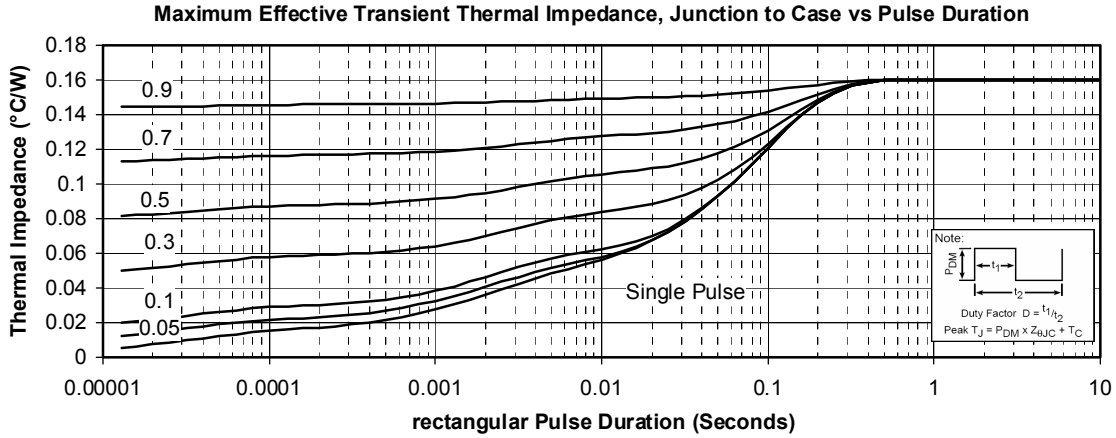
See application note APT0501 - Mounting Instructions for SP4 Power Modules on www.microsemi.com

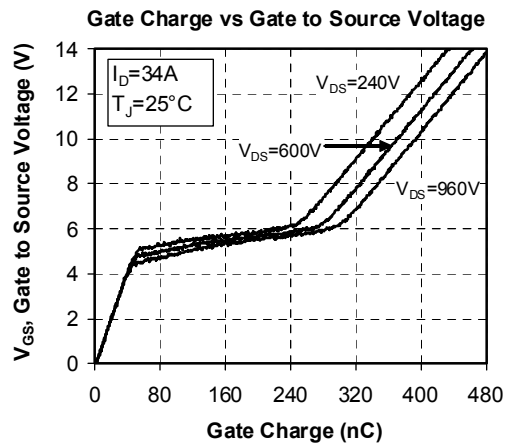
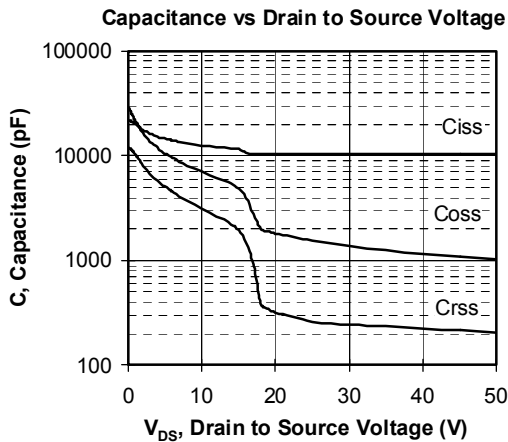
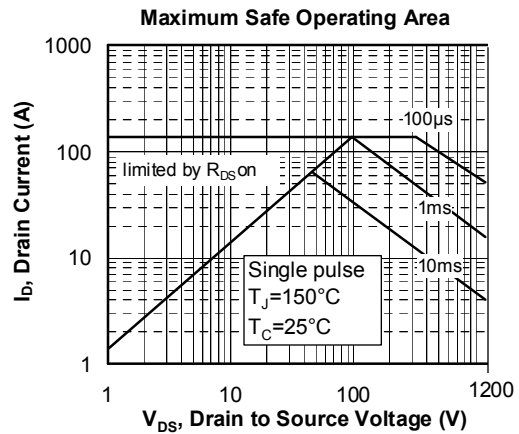
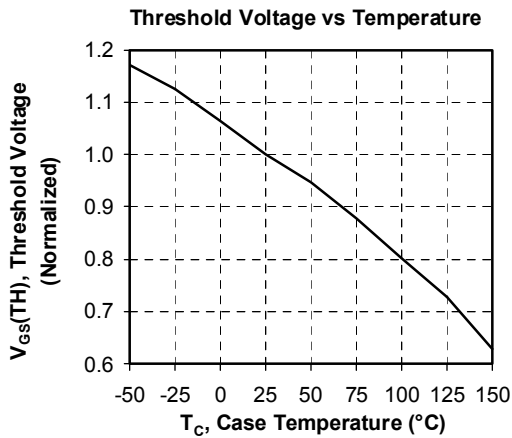
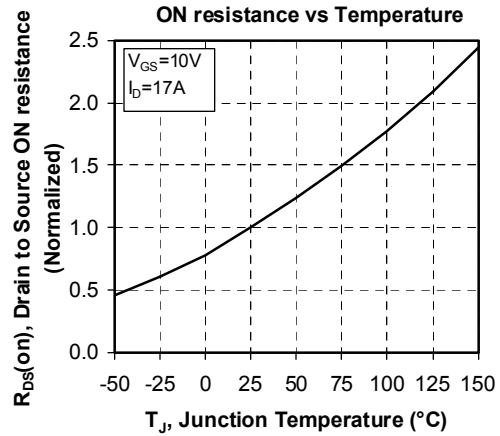
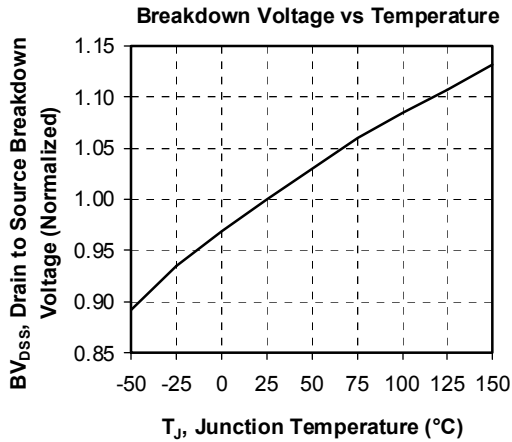
Typical Performance Curve

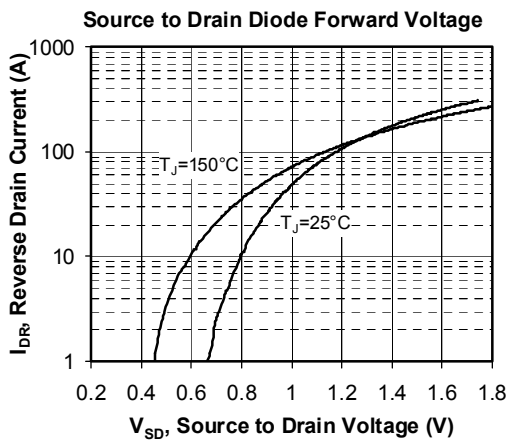
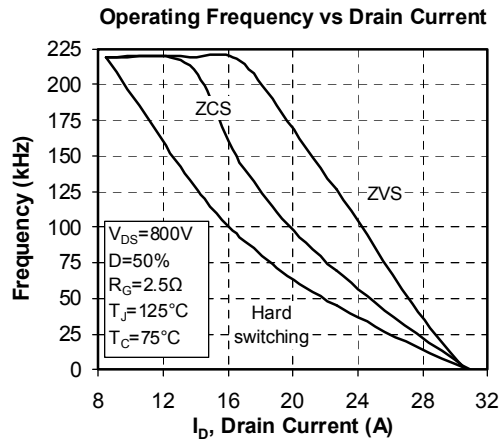
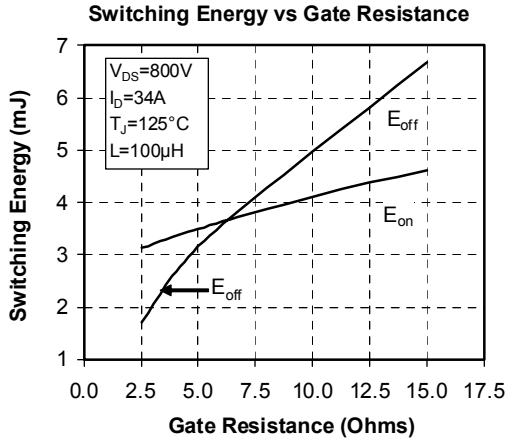
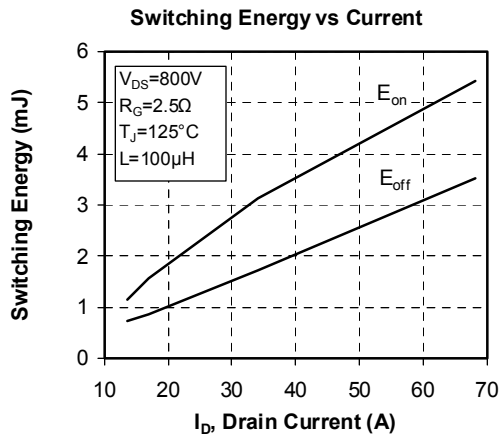
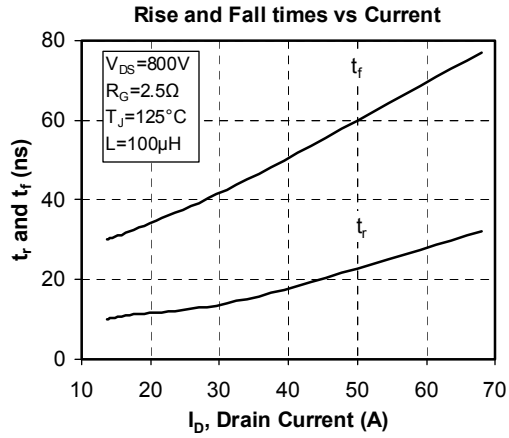
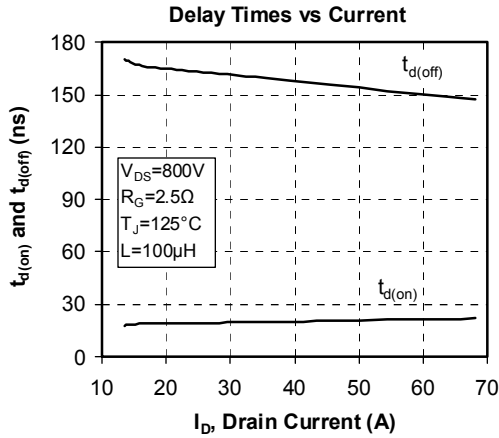



Microsemi reserves the right to change, without notice, the specifications and information contained herein

Microsemi's products are covered by one or more of U.S. patents 4,895,810 5,045,903 5,089,434 5,182,234 5,019,522 5,262,336 6,503,786 5,256,583 4,748,103 5,283,202 5,231,474 5,434,095 5,528,058 and foreign patents. U.S. and Foreign patents pending. All Rights Reserved.