

## 28V Synchronous Buck Controllers Featuring Adaptive ON-Time Control

### Features

- Hyper Speed Control Architecture Enables:
  - High delta V operation ( $V_{IN} = 28V$  and  $V_{OUT} = 0.6V$ )
  - Any Capacitor™ stable
- 4.5V to 28V Input Voltage
- Adjustable Output Voltage from 0.6V to 24V
- 200 kHz to 750 kHz Programmable Switching Frequency
- HyperLight Load® (MIC2125)
- Hyper Speed Control® (MIC2126)
- Enable Input and Power Good Output
- Built-in 5V Regulator for Single-Supply Operation
- Programmable current limit and “hiccup” mode short-circuit protection
- 7 ms internal soft-start, internal compensation, and thermal shutdown
- Supports Safe Start-Up into a Prebiased Output
- $-40^{\circ}C$  to  $+125^{\circ}C$  Junction Temperature Range
- Available in 16-pin, 3 mm x 3 mm QFN Package

### Applications

- Networking/Telecom Equipment
- Base Stations, Servers
- Distributed Power Systems
- Industrial Power Supplies

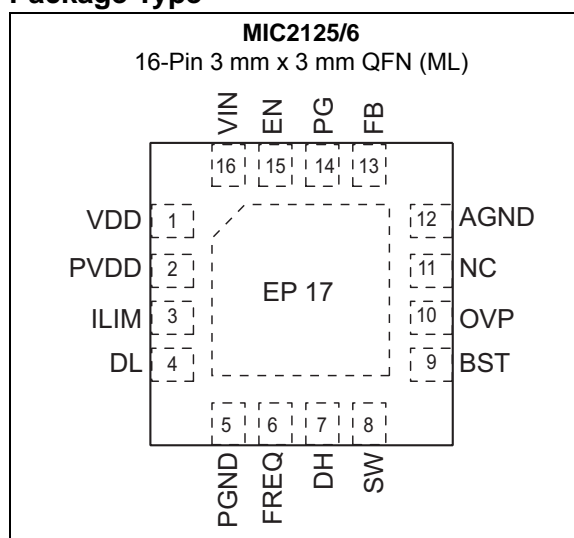
### General Description

The MIC2125 and MIC2126 are constant-frequency synchronous buck controllers featuring a unique adaptive ON-time control architecture. The MIC2125/6 operate over an input voltage range from 4.5V to 28V and can be used to supply load current up to 25A. The output voltage is adjustable down to 0.6V with a guaranteed accuracy of  $\pm 1\%$ . The device operates with programmable switching frequency from 200 kHz to 750 kHz.

HyperLight Load® architecture provides the same high efficiency and ultra-fast transient response as the Hyper Speed Control® architecture under medium to heavy loads. It also maintains high efficiency under light load conditions by transitioning to variable frequency, discontinuous conduction mode operation.

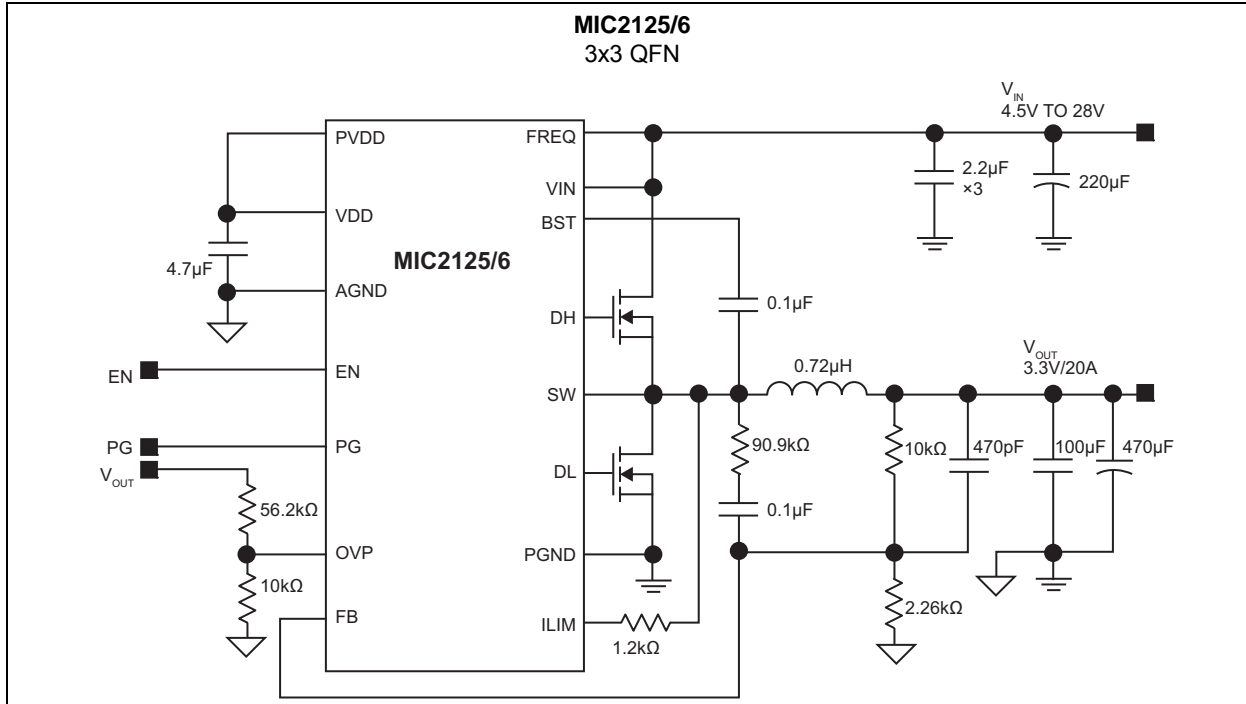
The MIC2125/6 offer a full suite of features to ensure protection of the IC during fault conditions. These include undervoltage lockout to ensure proper operation under power-sag conditions, internal soft-start to reduce inrush current, “hiccup” mode short-circuit protection, and thermal shutdown.

### Package Type

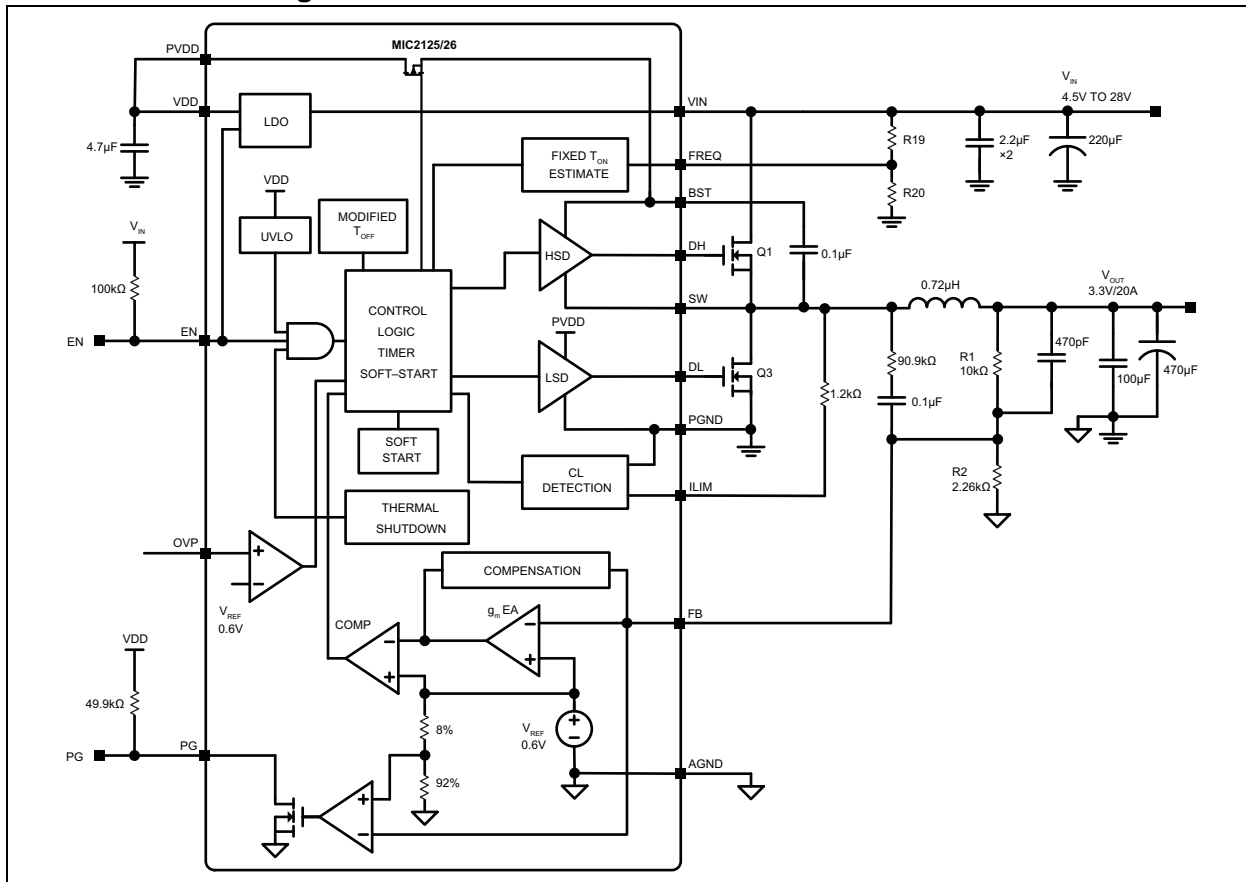


# MIC2125/6

## Typical Application Circuit



## Functional Block Diagram



## 1.0 ELECTRICAL CHARACTERISTICS

### Absolute Maximum Ratings †

$V_{IN}$ .....	-0.3V to +30V
$V_{DD}$ , $P_{VDD}$ .....	-0.3V to +6V
$V_{SW}$ , $V_{FREQ}$ , $V_{ILIM}$ , $V_{EN}$ .....	-0.3V to ( $V_{IN}$ + 0.3V)
$V_{BST}$ to $V_{SW}$ .....	-0.3V to 6V
$V_{BST}$ .....	-0.3V to 36V
$V_{PG}$ .....	-0.3V to ( $V_{DD}$ + 0.3V)
$V_{FB}$ .....	-0.3V to ( $V_{DD}$ + 0.3V)
$P_{GND}$ to $A_{GND}$ .....	-0.3V to +0.3V
ESD Rating <sup>(1)</sup> .....	2 kV

### Operating Ratings ‡

Supply Voltage ( $V_{IN}$ ).....	4.5V to 28V
$V_{SW}$ , $V_{FREQ}$ , $V_{ILIM}$ , $V_{EN}$ .....	0V to $V_{IN}$

† **Notice:** Stresses above those listed under “Absolute Maximum Ratings” may cause permanent damage to the device. This is a stress rating only and functional operation of the device at those or any other conditions above those indicated in the operational sections of this specification is not intended. Exposure to maximum rating conditions for extended periods may affect device reliability.

‡ **Notice:** The device is not guaranteed to function outside its operating ratings.

**Note 1:** Devices are ESD sensitive. Handling precautions are recommended. Human body model, 1.5 k $\Omega$  in series with 100 pF.

# MIC2125/6

**TABLE 1-1: ELECTRICAL CHARACTERISTICS**

<b>Electrical Characteristics:</b> $V_{IN} = 12V$ , $V_{OUT} = 1.2V$ , $V_{BST} - V_{SW} = 5V$ ; $T_A = 25^\circ C$ , unless noted. <b>Bold</b> values indicate $-40^\circ C \leq T_J \leq +125^\circ C$ . ( <b>Note 1</b> ).					
Parameters	Min.	Typ.	Max.	Units	Conditions
<b>Power Supply Input</b>					
Input Voltage Range ( $V_{IN}$ ) ( <b>Note 2</b> )	<b>4.5</b>	—	<b>5.5</b>	V	$V_{DD} = V_{IN}$
	<b>4.5</b>	—	<b>28</b>		—
Quiescent Supply Current (MIC2125)	—	340	<b>750</b>	$\mu A$	$V_{FB} = 1.5V$
Quiescent Supply Current (MIC2126)	—	1.1	<b>3</b>	mA	$V_{FB} = 1.5V$
Shutdown Supply Current	—	0.1	<b>5</b>	$\mu A$	SW unconnected, $V_{EN} = 0V$
<b><math>V_{DD}</math> Supply</b>					
$V_{DD}$ Output Voltage	<b>4.8</b>	5.2	<b>5.4</b>	V	$V_{IN} = 7V$ to $28V$ , $I_{DD} = 10$ mA
$V_{DD}$ UVLO Threshold	<b>3.7</b>	4.2	<b>4.5</b>		$V_{DD}$ rising
$V_{DD}$ UVLO Hysteresis	—	400	—	mV	—
Load Regulation	0.6	2	3.6	%	$I_{DD} = 0$ to $40$ mA
<b>Reference</b>					
Feedback Reference Voltage	0.597	0.6	0.603	V	$T_J = 25^\circ C$ ( $\pm 0.5\%$ )
	<b>0.594</b>	0.6	<b>0.606</b>		$-40^\circ C \leq T_J \leq +125^\circ C$ ( $\pm 1\%$ )
FB Bias Current	—	0.01	<b>0.5</b>	$\mu A$	$V_{FB} = 0.6V$
<b>Enable Control</b>					
EN Logic Level High	<b>1.6</b>	—	—	V	—
EN Logic Level Low	—	—	<b>0.6</b>		—
EN Hysteresis	—	120	—	mV	—
EN Bias Current	—	6	<b>30</b>	$\mu A$	$V_{EN} = 12V$
<b>Oscillator</b>					
Switching Frequency	—	750	—	kHz	$V_{FREQ} = V_{IN}$
	—	375	—		$V_{FREQ} = 50\% \times V_{IN}$
Maximum Duty Cycle	—	85	—	%	—
Minimum Duty Cycle	—	0	—		$V_{FB} > 0.6V$
Minimum On-Time	—	100	—	ns	—
Minimum Off-Time	150	220	300		—
<b>Soft-Start</b>					
Soft-Start Time	—	7	—	ms	—
<b>Short-Circuit Protection and OVP</b>					
Current-Limit Comparator Offset	-15	-4	7	mV	$V_{FB} = 0.6V$
Current-Limit Source Current	32	36	40	$\mu A$	$V_{FB} = 0.6V$

**Note 1:** Specification for packaged product only.

**2:** The application is fully functional at low  $V_{DD}$  (supply of the control section) if the external MOSFETs have low voltage  $V_{TH}$ .

**TABLE 1-1: ELECTRICAL CHARACTERISTICS (CONTINUED)**

**Electrical Characteristics:**  $V_{IN} = 12V$ ,  $V_{OUT} = 1.2V$ ,  $V_{BST} - V_{SW} = 5V$ ;  $T_A = 25^\circ C$ , unless noted. **Bold** values indicate  $-40^\circ C \leq T_J \leq +125^\circ C$ . (**Note 1**).

Parameters	Min.	Typ.	Max.	Units	Conditions
Overvoltage Protection Threshold	—	0.62	—	V	—
<b>FET Drivers</b>					
DH, DL Output Low Voltage	—	—	<b>0.1</b>	V	$I_{SINK} = 10\text{ mA}$
DH, DL Output High Voltage	$V_{PVDD}-0.1$ or $V_{BST}-0.1$	—	—		$I_{SOURCE} = 10\text{ mA}$
DH On-Resistance, High State	—	2.5	—	$\Omega$	—
DH On-Resistance, Low State	—	1.6	—		—
DL On-Resistance, High State	—	1.9	—		—
DL On-Resistance, Low State	—	0.55	—		—
SW, BST Leakage Current	—	—	50	$\mu A$	—
<b>Power Good (PG)</b>					
PG Threshold Voltage	<b>85</b>	89	<b>95</b>	% $V_{OUT}$	Sweep $V_{FB}$ from low to high
PG Hysteresis	—	6	—		Sweep $V_{FB}$ from high to low
PG Delay Time	—	80	—	$\mu s$	Sweep $V_{FB}$ from low to high
PG Low Voltage	—	60	<b>200</b>	mV	$V_{FB} < 90\% \times V_{NOM}$ , $I_{PG} = 1\text{ mA}$
<b>Thermal Protection</b>					
Overtemperature Shutdown	—	150	—	$^\circ C$	$T_J$ Rising
Overtemperature Shutdown Hysteresis	—	15	—	$^\circ C$	—

**Note 1:** Specification for packaged product only.

**2:** The application is fully functional at low  $V_{DD}$  (supply of the control section) if the external MOSFETs have low voltage  $V_{TH}$ .

# MIC2125/6

## TEMPERATURE SPECIFICATIONS

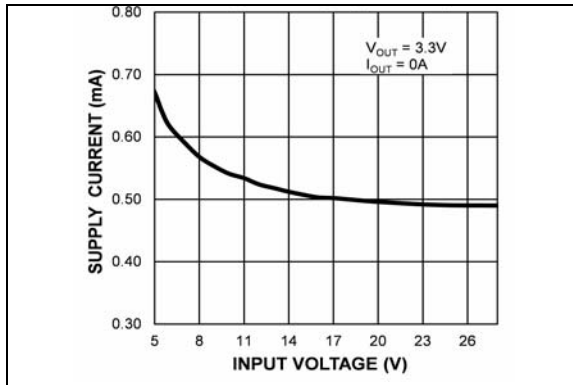
Parameters	Sym.	Min.	Typ.	Max.	Units	Conditions
<b>Temperature Ranges</b>						
Junction Operating Temperature	$T_J$	-40	—	+125	°C	Note 1
Storage Temperature Range	$T_S$	-65	—	+150	°C	—
Junction Temperature	$T_J$	—	—	+150	°C	—
Lead Temperature	—	—	—	+260	°C	Soldering, 10s
<b>Package Thermal Resistances</b>						
Thermal Resistance 3 mm x 3 mm QFN-16LD	$\theta_{JA}$	—	50.8	—	°C/W	—
	$\theta_{JC}$	—	25.3	—	°C/W	—

**Note 1:** The maximum allowable power dissipation is a function of ambient temperature, the maximum allowable junction temperature and the thermal resistance from junction to air (i.e.,  $T_A$ ,  $T_J$ ,  $\theta_{JA}$ ). Exceeding the maximum allowable power dissipation will cause the device operating junction temperature to exceed the maximum +125°C rating. Sustained junction temperatures above +125°C can impact the device reliability.

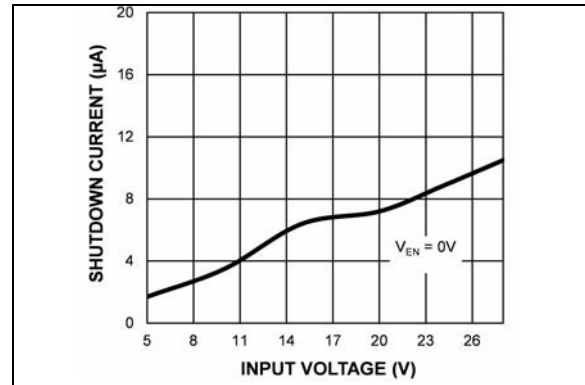
## 2.0 TYPICAL PERFORMANCE CURVES

**Note:** The graphs and tables provided following this note are a statistical summary based on a limited number of samples and are provided for informational purposes only. The performance characteristics listed herein are not tested or guaranteed. In some graphs or tables, the data presented may be outside the specified operating range (e.g., outside specified power supply range) and therefore outside the warranted range.

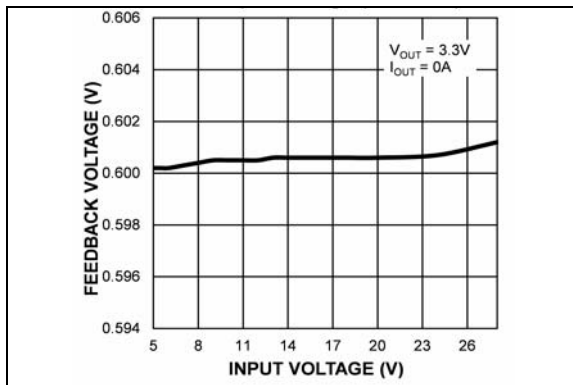
**Note:** Unless otherwise noted,  $V_{IN} = 12V$ ,  $FREQ = 350\text{ kHz}$ .



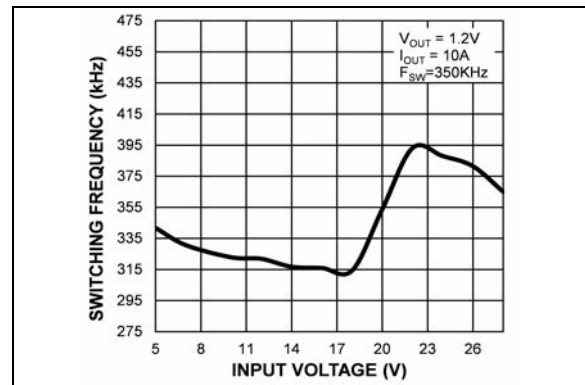
**FIGURE 2-1:**  $V_{IN}$  Operating Supply Current vs. Input Voltage (MIC2125).



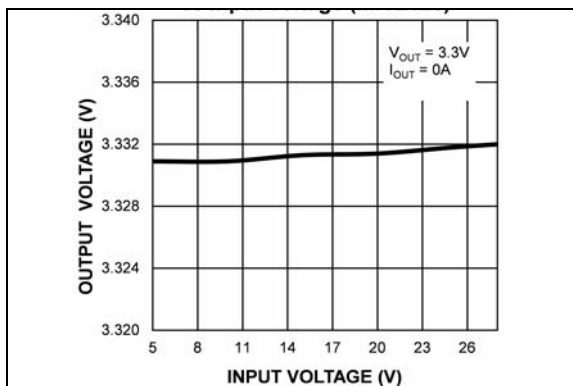
**FIGURE 2-4:**  $V_{IN}$  Shutdown Current vs. Input Voltage (MIC2125).



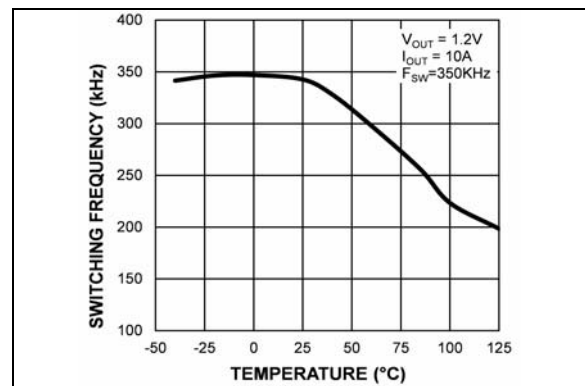
**FIGURE 2-2:** Feedback Voltage vs. Input Voltage (MIC2125).



**FIGURE 2-5:** Switching Frequency vs. Input Voltage.



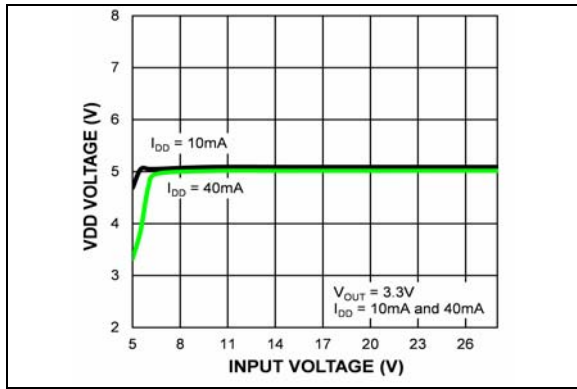
**FIGURE 2-3:** Output Voltage vs. Input Voltage (MIC2125).



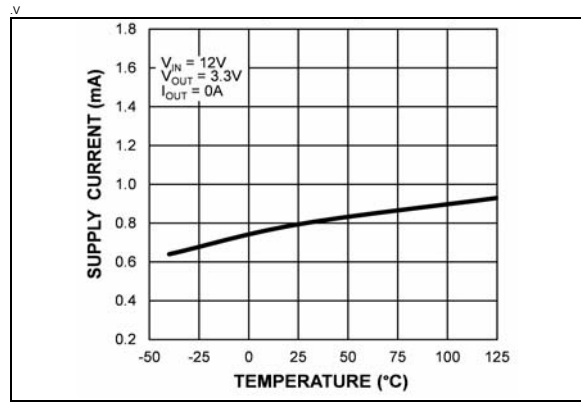
**FIGURE 2-6:** Switching Frequency vs. Temperature (MIC2126).

# MIC2125/6

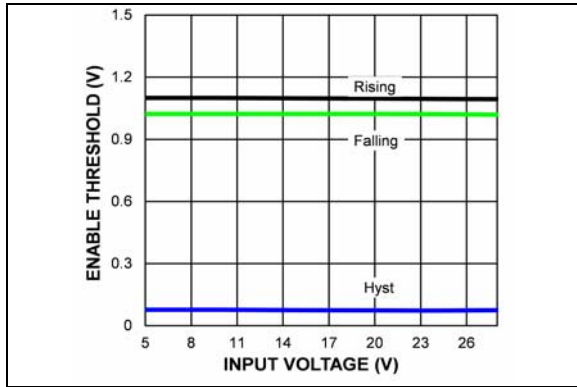
Note: Unless otherwise noted,  $V_{IN} = 12V$ , FREQ = 350 kHz.



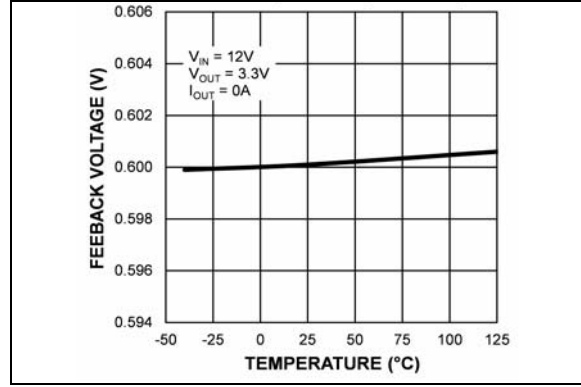
**FIGURE 2-7:**  $V_{DD}$  Voltage vs. Input Voltage (MIC2125).



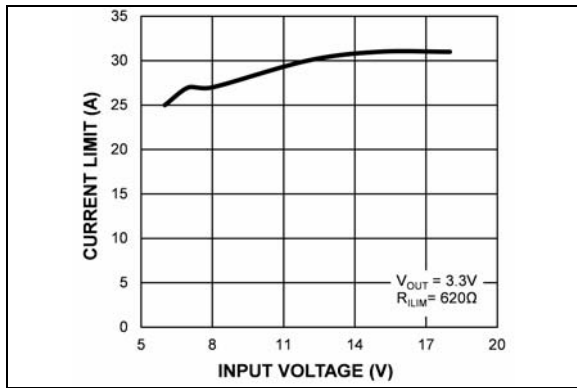
**FIGURE 2-10:**  $V_{IN}$  Operating Supply Current vs. Temperature (MIC2125).



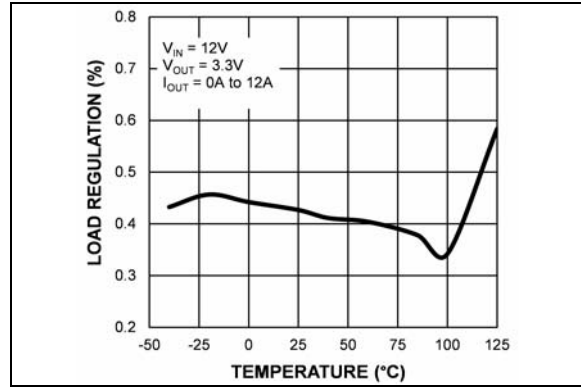
**FIGURE 2-8:** Enable Threshold vs. Input Voltage (MIC2125).



**FIGURE 2-11:** Feedback Voltage vs. Temperature (MIC2125).



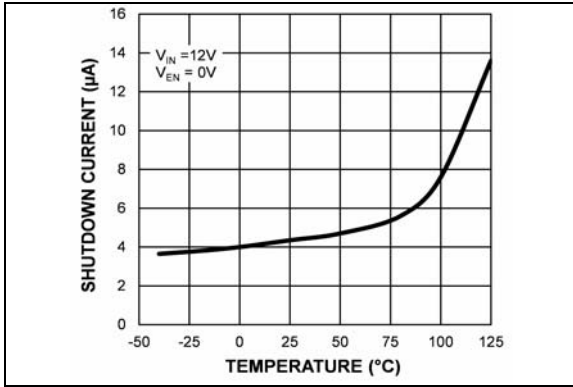
**FIGURE 2-9:** Output Peak Current Limit vs. Input Voltage (MIC2125).



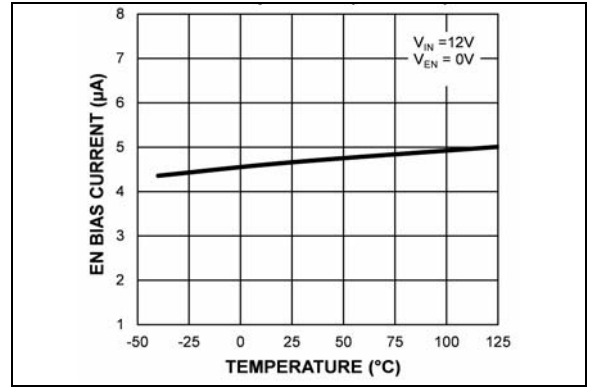
**FIGURE 2-12:** Load Regulation vs. Temperature (MIC2125).



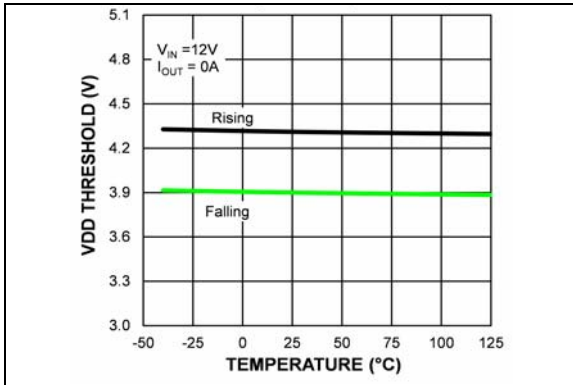
**Note:** Unless otherwise noted,  $V_{IN} = 12V$ ,  $FREQ = 350\text{ kHz}$ .



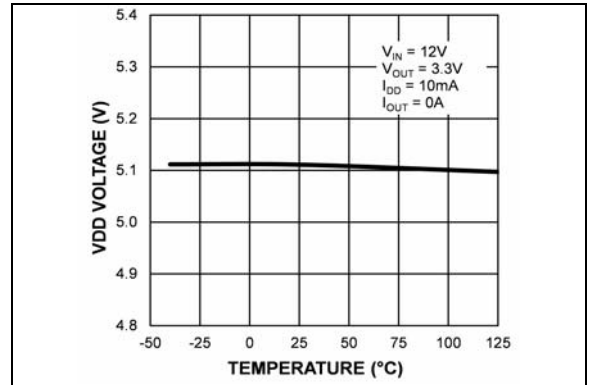
**FIGURE 2-13:**  $V_{IN}$  Shutdown Current vs. Temperature (MIC2125).



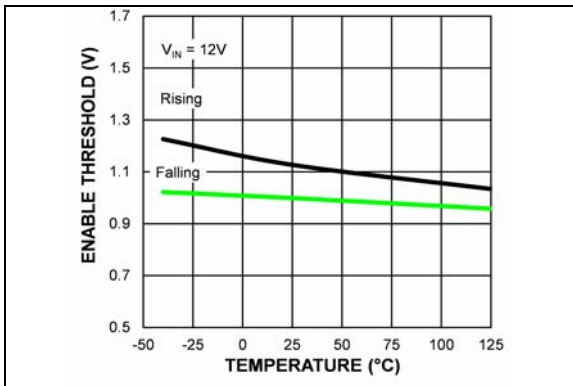
**FIGURE 2-16:** EN Bias Current vs. Temperature (MIC2125).



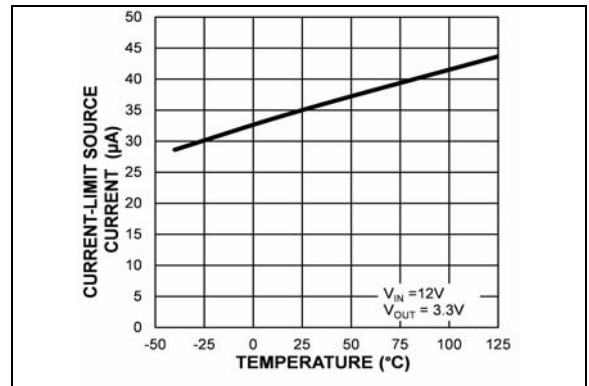
**FIGURE 2-14:**  $V_{DD}$  UVLO Threshold vs. Temperature (MIC2125).



**FIGURE 2-17:**  $V_{DD}$  Voltage vs. Temperature (MIC2125).



**FIGURE 2-15:** Enable Threshold vs. Temperature (MIC2125).

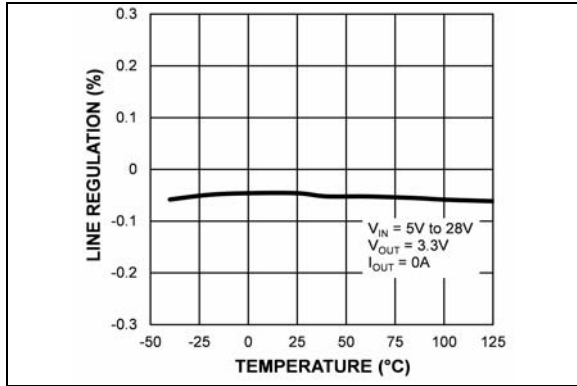


**FIGURE 2-18:** Current-Limit Source Current vs. Temperature (MIC2125).

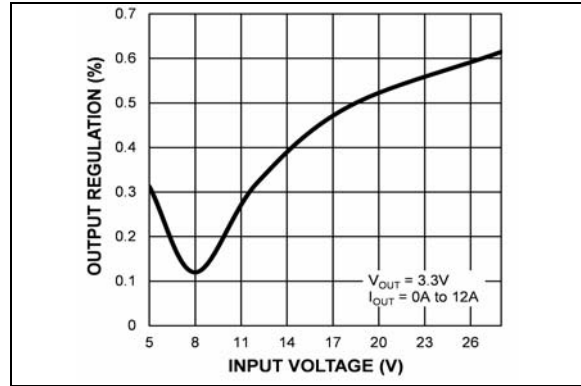
# MIC2125/6

**Note:** Unless otherwise noted,  $V_{IN} = 12V$ ,  $FREQ = 350\text{ kHz}$ .

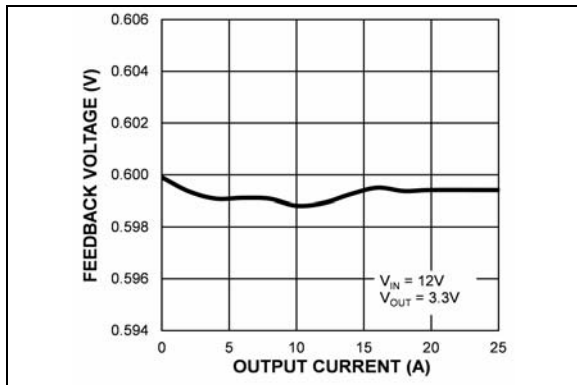
**\*Note:** For Case Temperature graphs: The temperature measurement was taken at the hottest point on the MIC2125/6 case mounted on a 5 square inch PCBn. Actual results will depend upon the size of the PCB, ambient temperature and proximity to other heat emitting components.



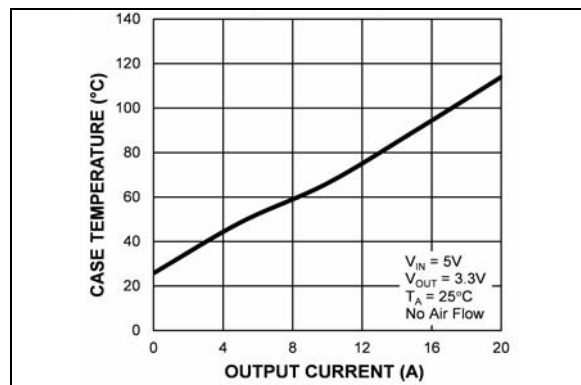
**FIGURE 2-19:** Line Regulation vs. Temperature (MIC2125).



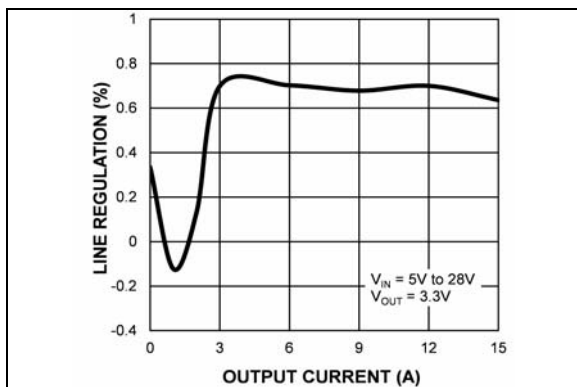
**FIGURE 2-22:** Output Regulation vs. Input Voltage (MIC2125).



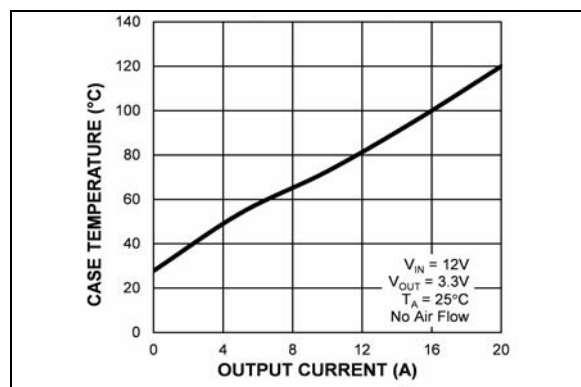
**FIGURE 2-20:** Feedback Voltage vs. Output Current (MIC2125).



**FIGURE 2-23:** Case Temperature\* vs. Output Current (MIC2125).



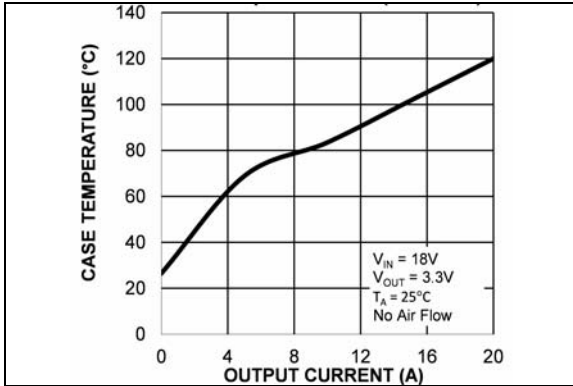
**FIGURE 2-21:** Line Regulation vs. Output Current (MIC2125).



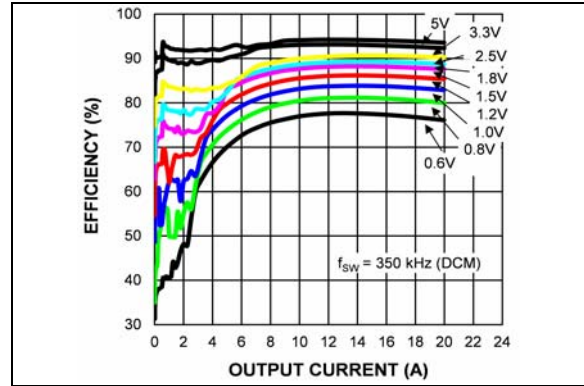
**FIGURE 2-24:** Case Temperature\* vs. Output Current (MIC2125).

**Note:** Unless otherwise noted,  $V_{IN} = 12V$ ,  $FREQ = 350\text{ kHz}$ .

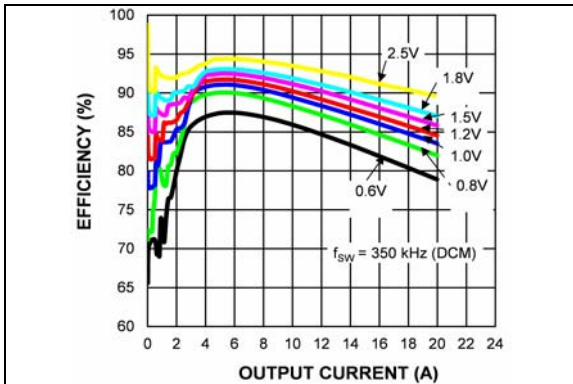
**\*Note:** For Case Temperature graphs: The temperature measurement was taken at the hottest point on the MIC2125/6 case mounted on a 5 square inch PCBn. Actual results will depend upon the size of the PCB, ambient temperature and proximity to other heat emitting components.



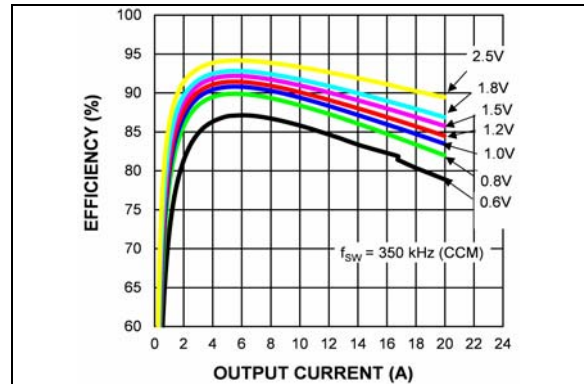
**FIGURE 2-25:** Case Temperature\* vs. Output Current (MIC2125).



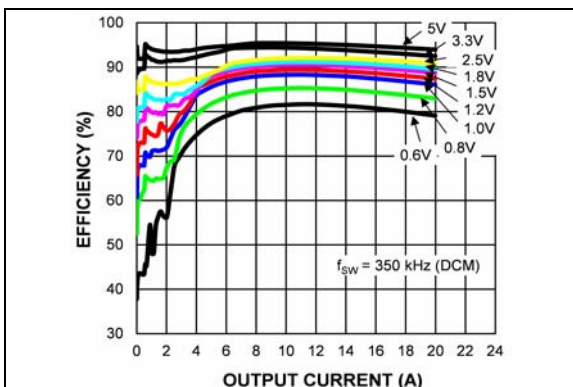
**FIGURE 2-28:** Efficiency ( $V_{IN} = 18V$ ) vs. Output Current (MIC2125).



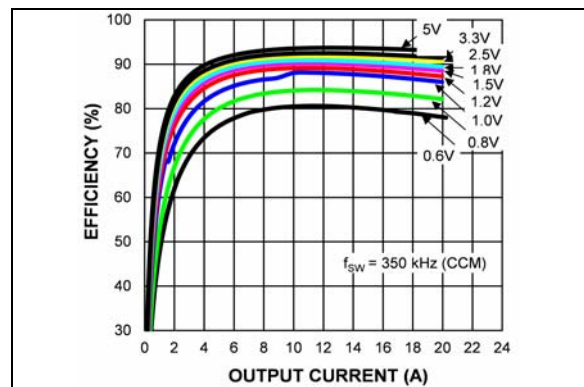
**FIGURE 2-26:** Efficiency ( $V_{IN} = 5V$ ) vs. Output Current (MIC2125).



**FIGURE 2-29:** Efficiency ( $V_{IN} = 5V$ ) vs. Output Current (MIC2126).



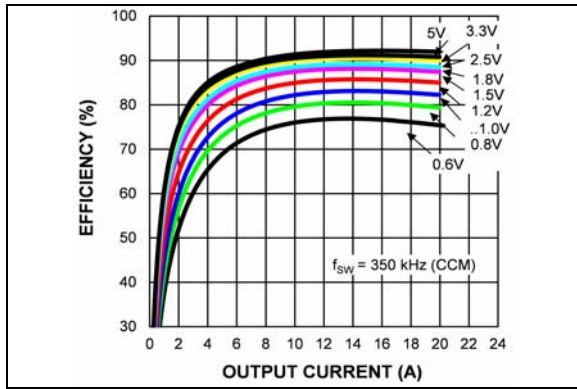
**FIGURE 2-27:** Efficiency ( $V_{IN} = 12V$ ) vs. Output Current (MIC2125).



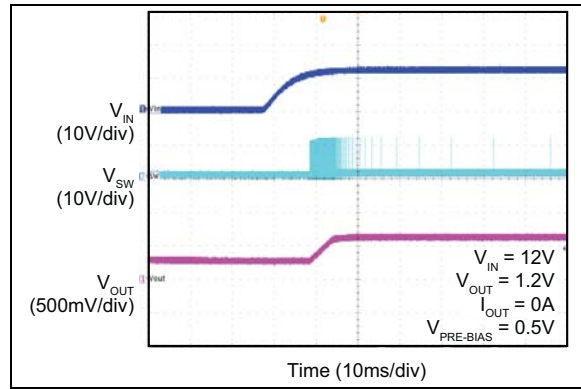
**FIGURE 2-30:** Efficiency ( $V_{IN} = 12V$ ) vs. Output Current (MIC2126).

# MIC2125/6

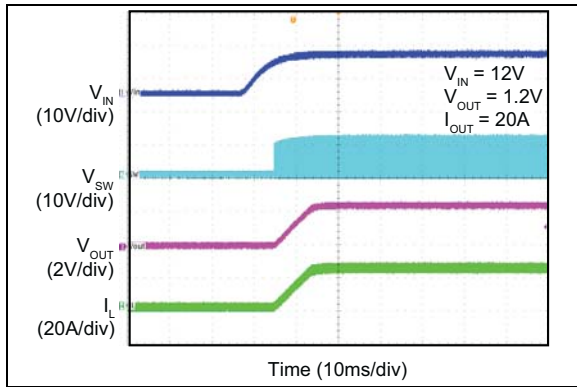
**Note:** Unless otherwise noted,  $V_{IN} = 12V$ ,  $FREQ = 350\text{ kHz}$ .



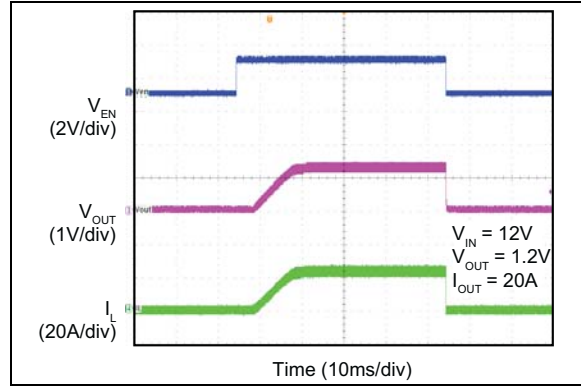
**FIGURE 2-31:** Efficiency ( $V_{IN} = 18V$ ) vs. Output Current (MIC2126).



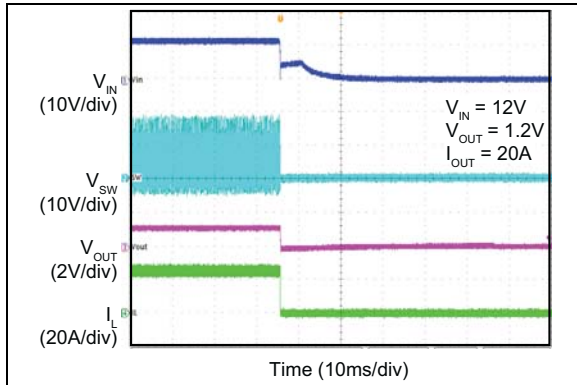
**FIGURE 2-34:** MIC2125  $V_{IN}$  Start-Up with Prebiased Output.



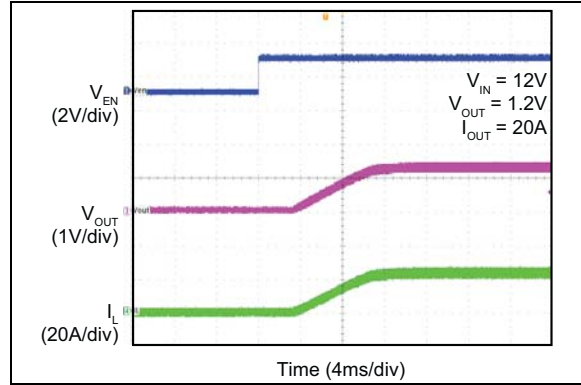
**FIGURE 2-32:**  $V_{IN}$  Soft Turn-On.



**FIGURE 2-35:** Enable Turn-On/Turn-Off.

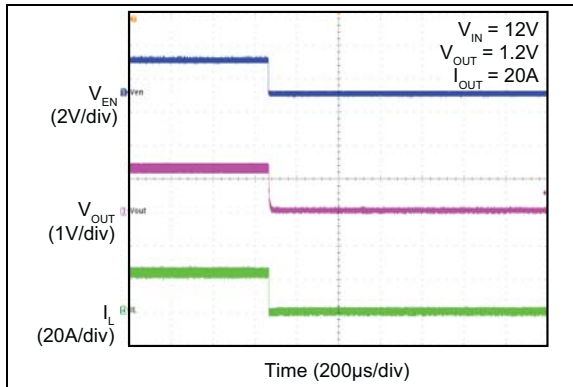


**FIGURE 2-33:**  $V_{IN}$  Soft Turn-Off.

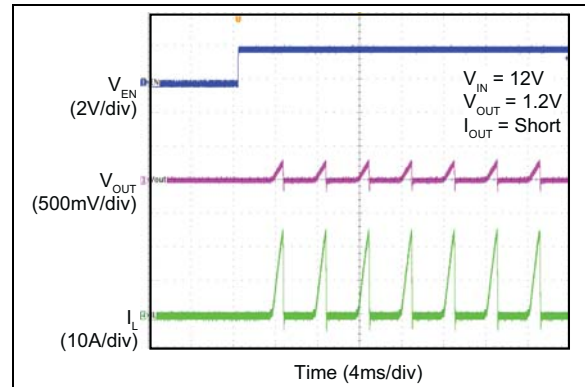


**FIGURE 2-36:** Enable Turn-On Delay and Rise Time.

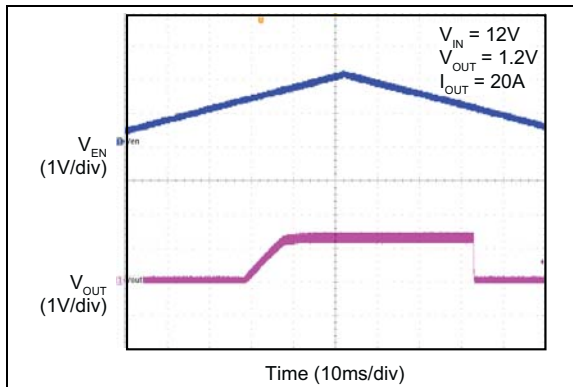
**Note:** Unless otherwise noted,  $V_{IN} = 12V$ ,  $FREQ = 350\text{ kHz}$ .



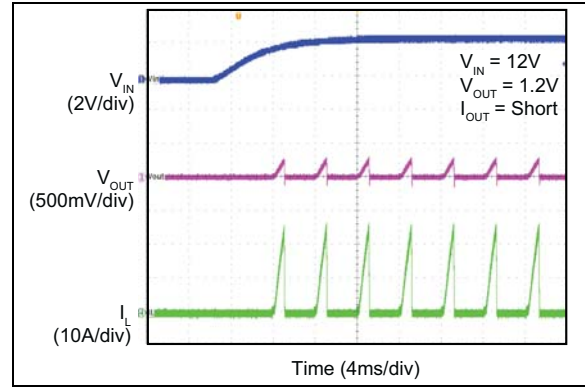
**FIGURE 2-37:** Enable Turn-Off Delay and Fall Time.



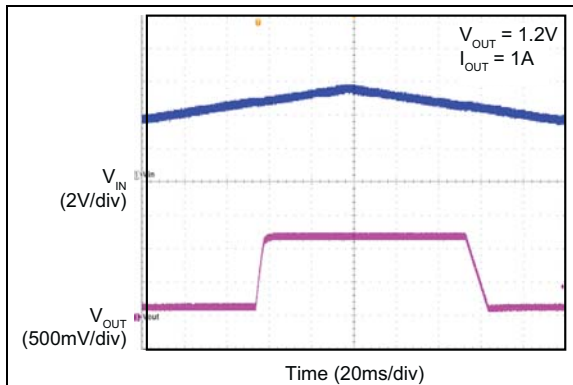
**FIGURE 2-40:** Enabled into Short.



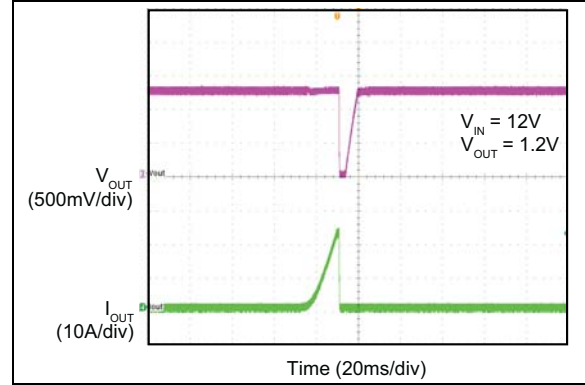
**FIGURE 2-38:** Enable Thresholds.



**FIGURE 2-41:** Power-Up into Short-Circuit.



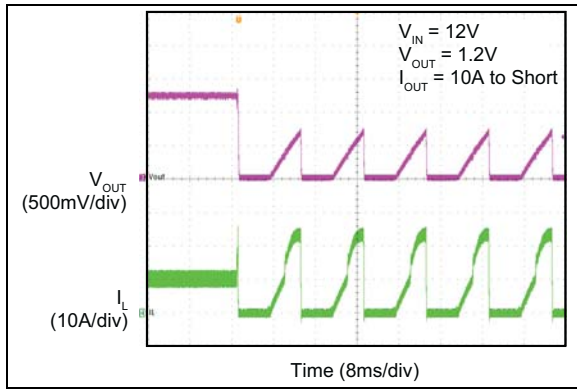
**FIGURE 2-39:** Enable Turn-On Delay and Rise Time.



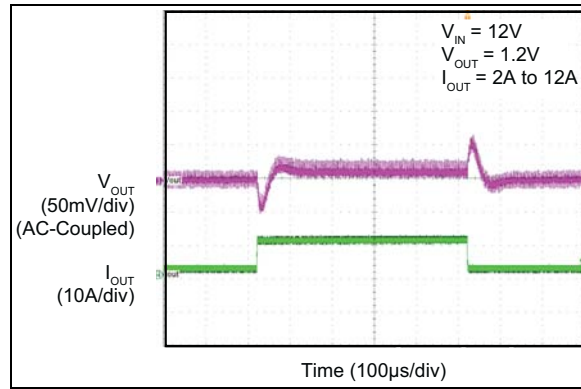
**FIGURE 2-42:** Output Peak Current-Limit Threshold.

# MIC2125/6

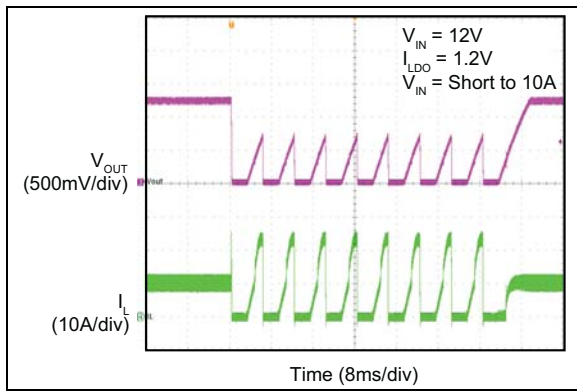
Note: Unless otherwise noted,  $V_{IN} = 12V$ ,  $FREQ = 350\text{ kHz}$ .



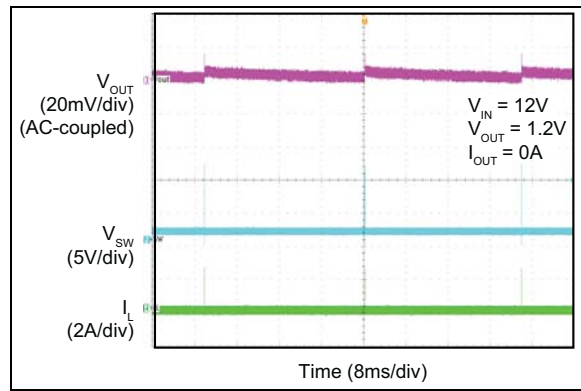
**FIGURE 2-43:** Short-Circuit.



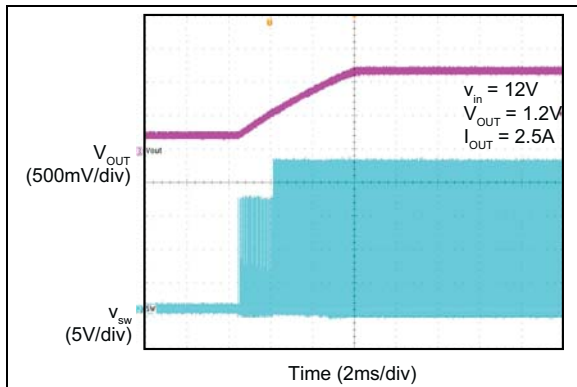
**FIGURE 2-46:** Transient Response.



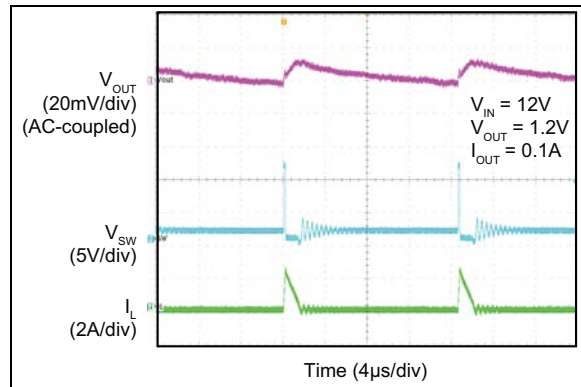
**FIGURE 2-44:** Output Recovery from Short-Circuit.



**FIGURE 2-47:** MIC2125 Switching Waveform,  $I_{OUT} = 0A$ .

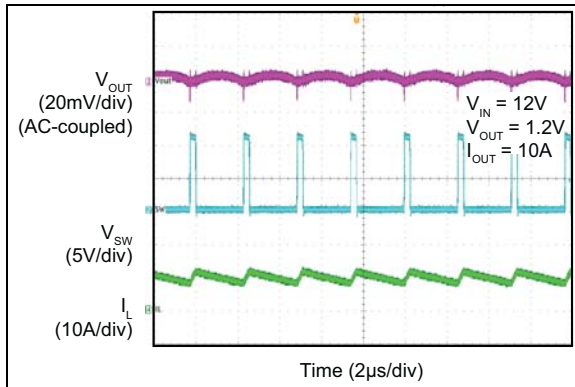


**FIGURE 2-45:** Output Recovery from Thermal Shutdown.

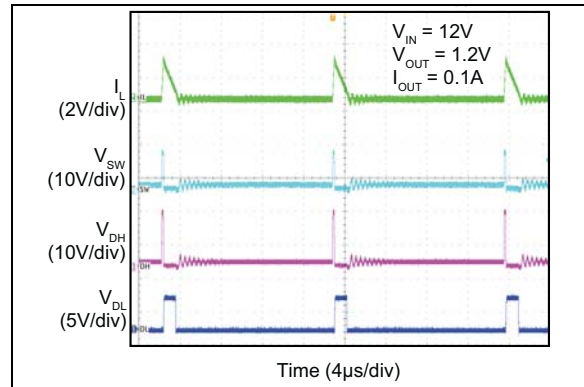


**FIGURE 2-48:** MIC2125 Switching Waveform,  $I_{OUT} = 0.1A$ .

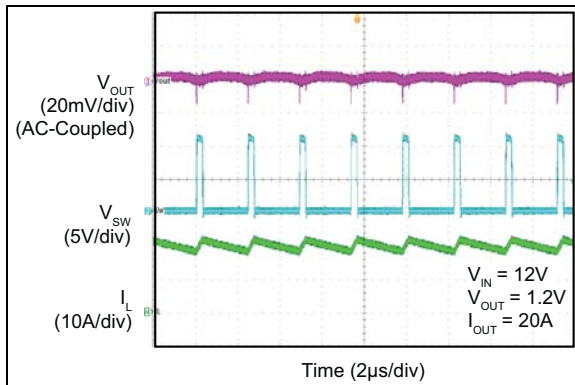
**Note:** Unless otherwise noted,  $V_{IN} = 12V$ ,  $FREQ = 350\text{ kHz}$ .



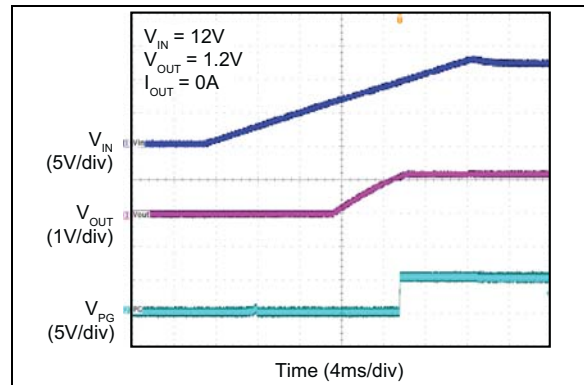
**FIGURE 2-49:** Switching Waveform,  $I_{OUT} = 10A$ .



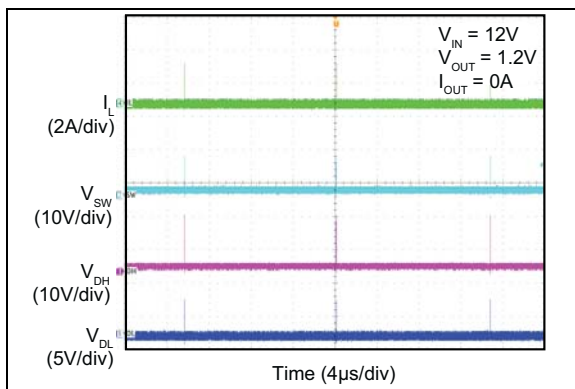
**FIGURE 2-52:** MIC2125 Switching Waveform,  $I_{OUT} = 0.1A$ .



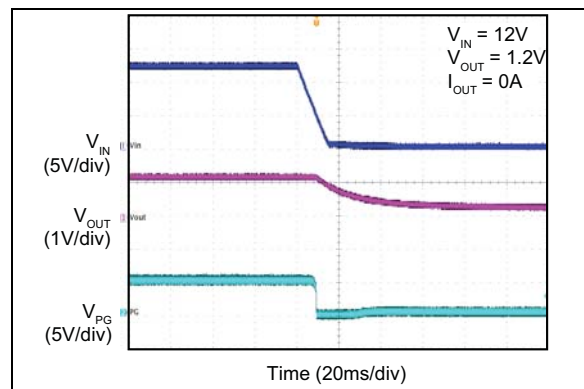
**FIGURE 2-50:** Switching Waveform,  $I_{OUT} = 20A$ .



**FIGURE 2-53:** Power Good at  $V_{IN}$  Soft Turn-On.



**FIGURE 2-51:** MIC2125 Switching Waveform,  $I_{OUT} = 0A$ .



**FIGURE 2-54:** Power Good at  $V_{IN}$  Soft Turn-Off.

# MIC2125/6

## 3.0 PIN DESCRIPTIONS

The descriptions of the pins are listed in [Table 3-1](#).

**TABLE 3-1: PIN FUNCTION TABLE**

Pin Number	Symbol	Description
1	V <sub>DD</sub>	Internal Linear regulator output. Connect a 4.7 $\mu$ F ceramic capacitor from V <sub>DD</sub> to A <sub>GND</sub> for decoupling. In the applications where V <sub>IN</sub> < +5.5V, V <sub>DD</sub> should be tied to V <sub>IN</sub> to by-pass the linear regulator.
2	P <sub>VDD</sub>	5V supply input for the low-side N-channel MOSFET driver, which can be tied to V <sub>DD</sub> externally. A 4.7 $\mu$ F ceramic capacitor from P <sub>VDD</sub> to P <sub>GND</sub> is recommended for decoupling.
3	I <sub>LIM</sub>	Current limit setting input. Connect a resistor from SW to I <sub>LIM</sub> to set the overcurrent threshold for the converter.
4	DL	Low-side gate driver output. The DL driving voltage swings from ground to V <sub>DD</sub> .
5	P <sub>GND</sub>	Power ground. P <sub>GND</sub> is the return path for the low side gate driver. Connect P <sub>GND</sub> pin to the source of low-side N-Channel external MOSFET.
6	FREQ	Switching frequency adjust input. Connect FREQ to the mid-point of an external resistor divider from V <sub>IN</sub> to GND to program the switching frequency. Tie to V <sub>IN</sub> to operate at 750 kHz frequency.
7	DH	High-side gate driver output. The DH driving voltage is floating on the switch node voltage (V <sub>SW</sub> ).
8	SW	Switch node and current-sense input. Connect the SW pin to the switch node of the buck converter. The SW pin also senses the current by monitoring the voltage across the low-side MOSFET during OFF time. In order to sense the current accurately, connect the low-side MOSFET drain to the SW pin using a Kelvin connection.
9	BST	Bootstrap Capacitor Input. Connect a ceramic capacitor with a minimum value of 0.1 $\mu$ F from BST to SW.
10	OVP	Output Overvoltage Protection Input. Connect to the mid-point of an external resistive divider from the V <sub>OUT</sub> to GND to program overvoltage limit. Connect to A <sub>GND</sub> if the output overvoltage protection is not required.
11	NC	No connect.
12	A <sub>GND</sub>	Analog Ground. Connect A <sub>GND</sub> to the exposed pad.
13	FB	Feedback input. Input to the transconductance amplifier of the control loop. The FB pin is regulated to 0.6V. A resistor divider connecting the feedback to the output is used to set the desired output voltage.
14	PG	Open-drain Power good output. Pull-up with an external pull-up resistor to V <sub>DD</sub> or to an external power rail.
15	EN	Enable input. A logic signal to enable or disable the buck converter operation. Logic-high enables the device; logic-low shuts down the regulator. In disable mode, the V <sub>DD</sub> supply current for the device is minimized to 0.1 $\mu$ A typically. Do not pull-up EN pin to V <sub>DD</sub> /P <sub>VDD</sub> .
16	V <sub>IN</sub>	Supply voltage input. The V <sub>IN</sub> operating voltage range is from 4.5V to 28V. A 1 $\mu$ F ceramic capacitor from V <sub>IN</sub> to A <sub>GND</sub> is required for decoupling.
17	EP	Exposed Pad. Connect the exposed pad to the A <sub>GND</sub> copper plane to improve the thermal performance.



## 4.0 FUNCTIONAL DESCRIPTION

The MIC2125 and MIC2126 are adaptive on-time synchronous buck controllers built for high input voltage to low output voltage applications. They are designed to operate over a wide input voltage range from 4.5V to 28V and their output is adjustable with an external resistive divider. An adaptive ON-time control scheme is employed to obtain a constant switching frequency and to simplify the control compensation. Overcurrent protection is implemented when sensing low-side MOSFET's  $R_{DS(ON)}$ . The device features internal soft-start, enable, UVLO, and thermal shutdown.

### 4.1 Theory of Operation

The MIC2125/6 [Functional Block Diagram](#) appears on page two. The output voltage is sensed by the MIC2125/6 feedback pin (FB), and is compared to a 0.6V reference voltage ( $V_{REF}$ ) at the low gain transconductance error amplifier ( $g_m$ ). [Figure 4-1](#) shows the MIC2125/6 control loop timing during steady-state operation. When the feedback voltage decreases and the amplifier output is below 0.6V, the comparator triggers and generates an ON-time period. The ON-time period is predetermined by the fixed  $t_{ON}$  estimator circuitry value from [Equation 4-1](#):

#### EQUATION 4-1:

$$t_{ON(ESTIMATED)} = \frac{V_{OUT}}{V_{IN} \times f_{SW}}$$

Where:

$V_{OUT}$	Output Voltage
$V_{IN}$	Power Stage Input Voltage
$f_{SW}$	Switching Frequency

At the end of the ON-time, the internal high-side driver turns off the high-side MOSFET and the low-side driver turns on the low-side MOSFET. The OFF-time depends upon the feedback voltage. When the feedback voltage decreases and the output of the  $g_m$  amplifier is below 0.6V, the ON-time period is triggered and the OFF-time period ends. If the OFF-time period determined by the feedback voltage is less than the minimum OFF-time  $t_{OFF(min)}$ , which is about 220 ns, the MIC2125/6 control logic applies the  $t_{OFF(min)}$  instead.  $t_{OFF(min)}$  is required to maintain enough energy in the boost capacitor ( $C_{BST}$ ) to drive the high-side MOSFET.

The maximum duty cycle is obtained from the 220 ns  $t_{OFF(MIN)}$ :

#### EQUATION 4-2:

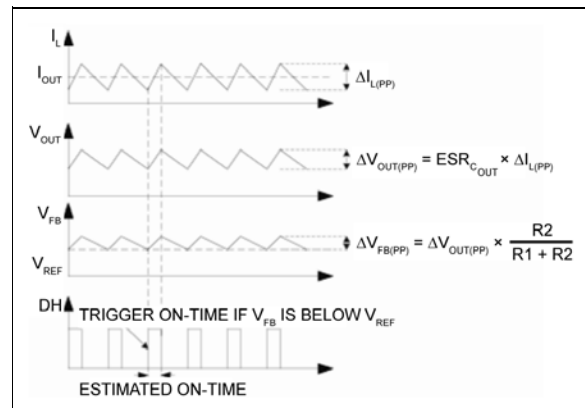
$$D_{MAX} = \frac{t_S - t_{OFF(MIN)}}{t_S} = 1 - \frac{220ns}{t_S}$$

Where:

$t_S$	$1/f_{SW}$
-------	------------

It is not recommended to use MIC2125/6 with an OFF-time close to  $t_{OFF(MIN)}$  during steady-state operation.

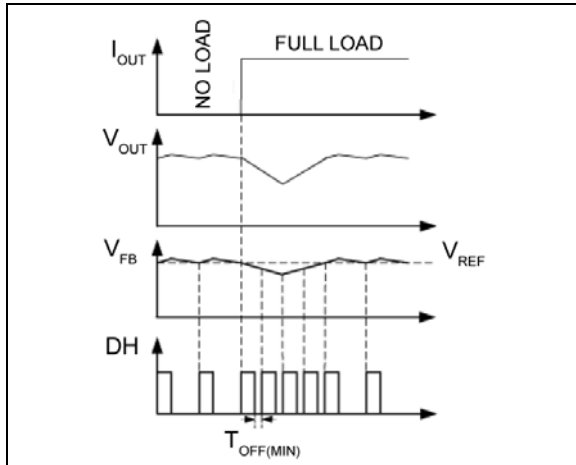
The adaptive ON-time control scheme results in a constant switching frequency in the MIC2125/6. The actual ON-time and resulting switching frequency varies with the different rising and falling times of the external MOSFETs. Also, the minimum  $t_{ON}$  results in a lower switching frequency in high  $V_{IN}$  to  $V_{OUT}$  applications.



**FIGURE 4-1:** MIC2125/6 Control Loop Timing

[Figure 4-2](#) shows the operation of the MIC2125/6 during load transient. The output voltage drops due to a sudden increase in load, which results in the  $V_{FB}$  falling below  $V_{REF}$ . This causes the comparator to trigger an ON-time period. At the end of the ON-time, a minimum OFF-time  $t_{OFF(min)}$  is generated to charge  $C_{BST}$  if the feedback voltage is still below  $V_{REF}$ . The next ON-time is triggered immediately after the  $t_{OFF(min)}$  due to the low feedback voltage. This operation results in higher switching frequency during load transients. The switching frequency returns to the nominal set frequency once the output stabilizes at new load current level. The output recovery time is fast and the output voltage deviation is small in MIC2125/6 converter due to the varying duty cycle and switching frequency.

# MIC2125/6

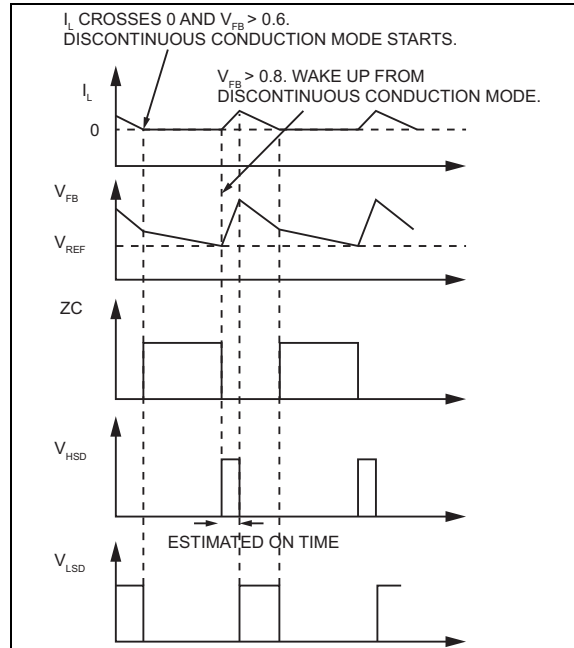


**FIGURE 4-2:** MIC2125/6 Load Transient Response

Unlike true current-mode control, the MIC2125/6 uses the output voltage ripple to trigger an ON-time period. In order to meet the stability requirements, the MIC2125/6 feedback voltage ripple should be in phase with the inductor current ripple and large enough to be sensed by the  $g_m$  amplifier. The recommended feedback voltage ripple is 20 mV ~ 100 mV over the full input voltage range. If a low-ESR output capacitor is selected, then the feedback voltage ripple may be too small to be sensed by the  $g_m$  amplifier. Also, the output voltage ripple and the feedback voltage ripple are not necessarily in phase with the inductor current ripple if the ESR of the output capacitor is very low. For these applications, ripple injection is required to ensure proper operation. Refer to the [Ripple Injection](#) section under [Application Information](#) for details about the ripple injection technique.

## 4.2 Discontinuous Conduction Mode (MIC2125 Only)

The MIC2125 operates in discontinuous conduction mode at light load. The MIC2125 has a zero crossing comparator (ZC detection) that monitors the inductor current by sensing the voltage drop across the low-side MOSFET during its ON-time. If the  $V_{FB} > 0.6V$  and the inductor current goes slightly negative, the MIC2125 turns off both the high-side and low-side MOSFETs. During this period, the efficiency is optimized by shutting down all the non-essential circuits and the load current is supplied by the output capacitor. The control circuitry wakes up when the feedback voltage falls below  $V_{REF}$  and triggers a  $t_{ON}$  pulse. [Figure 4-3](#) shows the control loop timing in discontinuous conduction mode.



**FIGURE 4-3:** MIC2125 Control Loop Timing (Discontinuous Conduction Mode)

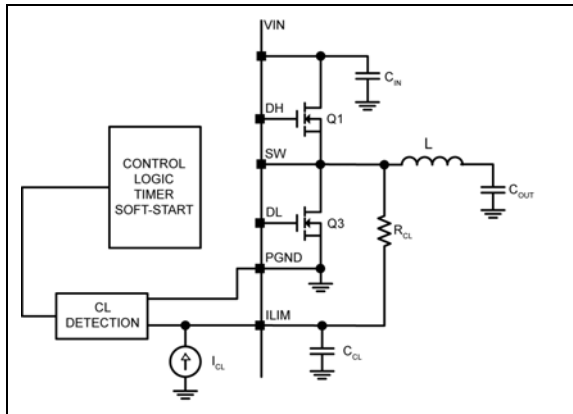
The typical no load supply current during discontinuous conduction mode is only about 340  $\mu A$ , allowing the MIC2125 to achieve high efficiency at light load operation.

## 4.3 Soft-Start

Soft-start reduces the power supply inrush current at startup by controlling the output voltage rise time. The MIC2125/6 implements an internal digital soft-start by ramping up the reference voltage  $V_{REF}$  from 0 to 100% in about 7 ms. Once the soft-start is completed, the related circuitry is disabled to reduce the current consumption.

## 4.4 Current Limit

The MIC2125/6 uses the low-side MOSFET  $R_{DS(ON)}$  to sense the inductor current.



**FIGURE 4-4:** MIC2125/6 Current-Limiting Circuit

In each switching cycle of the MIC2125/6 converter, the inductor current is sensed by monitoring the voltage across the low-side MOSFET during the OFF period. An internal current source of 36  $\mu\text{A}$  generates a voltage across the external resistor  $R_{CL}$ . The  $I_{LIM}$  pin voltage  $V_{(ILIM)}$  is the sum of the voltage across the low side MOSFET and the voltage across the resistor ( $V_{CL}$ ). The sensed voltage  $V_{(ILIM)}$  is compared with the power ground ( $P_{GND}$ ) after a blanking time of 150 ns.

If the absolute value of the voltage drop across the low side MOSFET is greater than  $V_{CL}$ , the current limit event is triggered. Eight consecutive current limit events triggers hiccup mode. The hiccup sequence, including the soft-start, reduces the stress on the switching FETs and protects the load and supply from severe short conditions.

The current limit can be programmed by using Equation 4-3.

### EQUATION 4-3:

$$R_{CL} = \frac{(I_{CLIM} + \Delta_{PP} \times 0.5) \times R_{DS(ON)} - V_{OFFSET}}{I_{CL}}$$

Where:

$I_{CLIM}$	Desired Current Limit
$\Delta_{PP}$	Inductor Current Peak-to-Peak
$R_{DS(ON)}$	On-Resistance of Low-Side Power MOSFET
$V_{OFFSET}$	Current-Limit Comparator Offset (Typical Value is $-4$ mV per Table 1-1)
$I_{CL}$	Current-Limit Source Current (Typical Value is 36 $\mu\text{A}$ , per Table 1-1)

Because MOSFET  $R_{DS(ON)}$  varies from 30% to 40% with temperature, it is recommended to add a 50% margin to  $I_{CL}$  in the previous equation to avoid false current limiting due to increased MOSFET junction temperature rise. It is also recommended to connect the SW pin directly to the drain of the low-side MOSFET to accurately sense the MOSFET's  $R_{DS(ON)}$ .

## 4.5 Negative Current Limit (MIC2126 Only)

The MIC2126 implements negative current limit by sensing the SW voltage when the low-side FET is off. If the SW node voltage exceeds 12 mV typical, the device turns off the low-side FET until the next ON-time event is triggered. The negative current limit value is given by Equation 4-4.

### EQUATION 4-4:

$$I_{NLIM} = \frac{12mV}{R_{DS(ON)}}$$

Where:

$I_{NLIM}$	Negative Current Limit
$R_{DS(ON)}$	On-Resistance of Low-Side Power MOSFET

## 4.6 MOSFET Gate Drive

The MIC2125/6 high-side drive circuit is designed to switch an N-Channel MOSFET. Figure 4-1 shows a bootstrap circuit, consisting of a PMOS switch and  $C_{BST}$ . This circuit supplies energy to the high-side drive circuit. Capacitor  $C_{BST}$  is charged while the low-side MOSFET is on and the voltage on the SW pin is approximately 0V. When the high-side MOSFET driver is turned on, energy from  $C_{BST}$  is used to turn the MOSFET on. If the bias current of the high-side driver is less than 10 mA, a 0.1  $\mu\text{F}$  capacitor is sufficient to hold the gate voltage within minimal droop, (i.e.,  $\Delta_{BST} = 10 \text{ mA} \times 3.33 \mu\text{s}/0.1 \mu\text{F} = 333 \text{ mV}$ ). A small resistor,  $R_G$  in series with  $C_{BST}$ , can be used to slow down the turn-on time of the high-side N-channel MOSFET.

## 4.7 Overvoltage Protection

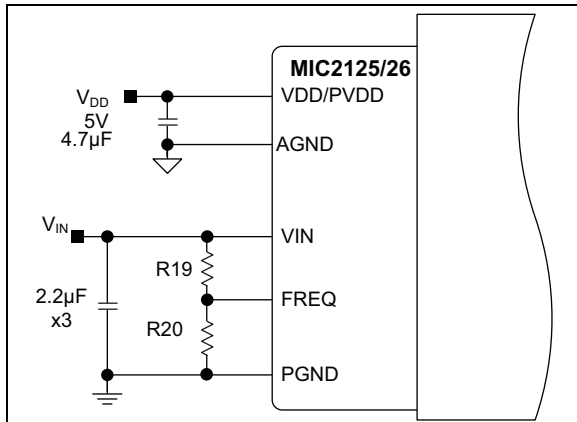
The MIC2125/6 includes the OVP feature to protect the load from overshoots due to input transients and output short to a high voltage. When the overvoltage condition is triggered, the converter turns off immediately to allow the output voltage to discharge. The MIC2125/6 power should be recycled to enable it again.

# MIC2125/6

## 5.0 APPLICATION INFORMATION

### 5.1 Setting the Switching Frequency

The MIC2125/6 are adjustable-frequency, synchronous buck controllers featuring a unique adaptive ON-time control architecture. The switching frequency can be adjusted between 200 kHz and 750 kHz by changing the resistor divider network consisting of R19 and R20.



**FIGURE 5-1:** Switching Frequency Adjustment.

Equation 5-1 gives the estimated switching frequency.

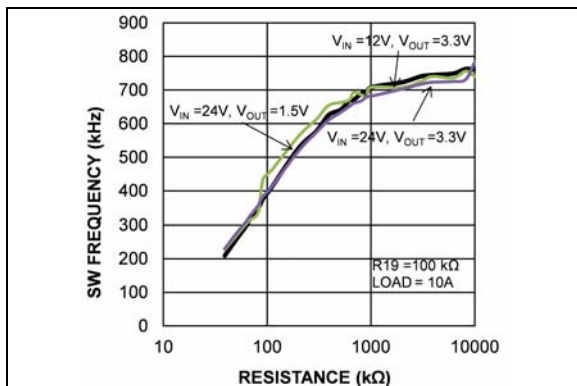
#### EQUATION 5-1:

$$f_{SW(ADJ)} = f_O \times \frac{R20}{R19 + R20}$$

Where:

$f_O$  Switching Frequency when R19 is 100 k $\Omega$  and R20 is open.  $f_O$  is typically 750 kHz.

For more precise setting, it is recommended to use Figure 5-2.



**FIGURE 5-2:** Switching Frequency vs. R20

### 5.2 MOSFET Selection

Voltage rating, on-resistance, and total gate charge are important parameters for MOSFET selection.

The voltage rating for the high-side and low-side MOSFETs are essentially equal to the power stage input voltage  $V_{IN}$ . A safety factor of 30% should be added to the  $V_{IN(MAX)}$  while selecting the voltage rating of the MOSFETs to account for voltage spikes due to circuit parasitic elements.

The power dissipated in the MOSFETs is the sum of conduction losses ( $P_{CONDUCTION}$ ) and switching losses ( $P_{AC}$ ).

#### EQUATION 5-2:

$$P_{SW} = P_{CONDUCTION} + P_{AC}$$

#### EQUATION 5-3:

$$P_{CONDUCTION} = I_{SW(RMS)}^2 \times R_{DS(ON)}$$

Where:

$R_{DS(ON)}$  On-Resistance of the MOSFET  
 $I_{SW(RMS)}$  RMS current of the MOSFET

The total high-side MOSFET switching loss is:

#### EQUATION 5-4:

$$P_{AC} = 0.5 \times V_{IN} \times I_{LOAD} \times (t_R + t_F) \times f_{SW}$$

Where:

$t_R/t_F$  Switching Transition Times  
 $I_{LOAD}$  Load Current  
 $f_{SW}$  Switching Frequency

Turn-on and turn-off transition times can be approximated by:

#### EQUATION 5-5:

$$t_R = \frac{Q_{SW(HS)} \times (R_{HSD(PULL-UP)} + R_{HS(GATE)})}{V_{DD} - V_{TH}}$$

## EQUATION 5-6:

$$t_F = \frac{Q_{SW(HS)} \times (R_{HSD(PULL-UP)} + R_{HS(GATE)})}{V_{TH}}$$

Where:

$R_{HSD(PULL-UP)}$	High-Side Gate Driver Pull-Up Resistance
$R_{HSD(PULL-DOWN)}$	High-Side Gate Driver Pull-Down Resistance
$R_{HS(GATE)}$	High-Side MOSFET Gate Resistance
$Q_{SW(HS)}$	Switching Gate Charge of the High-Side MOSFET
$V_{TH}$	Gate Threshold Voltage

The high-side MOSFET switching losses increase with the switching frequency and the input voltage. The low-side MOSFET switching losses are negligible and can be ignored for these calculations.

## 5.3 Inductor Selection

Inductance value, saturation, and RMS currents are required to select the output inductor. The input and output voltages and the inductance value determine the peak-to-peak inductor ripple current. Larger peak-to-peak ripple current increases the power dissipation in the inductor and MOSFETs. Larger output ripple current also requires more output capacitance to smooth out the larger ripple current. Smaller peak-to-peak ripple current requires a larger inductance value and therefore a larger and more expensive inductor.

A good compromise between size, loss, and cost is to set the inductor ripple current to be equal to 40% of the maximum output current.

The inductance value is calculated by [Equation 5-7](#).

## EQUATION 5-7:

$$L = \frac{V_{OUT} \times (V_{IN(MAX)} - V_{OUT})}{V_{IN(MAX)} \times f_{SW} \times 0.4 \times I_{OUT(MAX)}}$$

Where:

$f_{SW}$	Switching Frequency
0.4	Ratio of AC Ripple Current to DC Output Current
$V_{IN(MAX)}$	Maximum Power Stage Input Voltage

The peak-to-peak inductor current ripple is:

## EQUATION 5-8:

$$\Delta I_{L(PP)} = \frac{V_{OUT} \times (V_{IN(MAX)} - V_{OUT})}{V_{IN(MAX)} \times f_{SW} \times L}$$

The peak inductor current is equal to the average output current plus one half of the peak-to-peak inductor current ripple.

## EQUATION 5-9:

$$I_{L(PK)} = I_{OUT(MAX)} + 0.5 \times \Delta I_{L(PP)}$$

The saturation current rating is given by:

## EQUATION 5-10:

$$I_{L(SAT)} = \frac{(R_{CL} \times I_{CL}) - V_{OFFSET}}{R_{DS(ON)}}$$

Where:

$R_{CL}$	Current-Limit Resistor
$I_{CL}$	Current-Limit Source Current
$V_{OFFSET}$	Current-Limit Comparator Offset
$R_{DS(ON)}$	On-Resistance of Low-Side Power MOSFET

The RMS inductor current is used to calculate the  $I^2R$  losses in the inductor.

## EQUATION 5-11:

$$I_{L(RMS)} = \sqrt{I_{OUT(MAX)}^2 + \frac{\Delta I_{L(PP)}^2}{12}}$$

Maximizing efficiency requires the proper selection of core material and minimizing the winding resistance. The high-frequency operation of the MIC2125/6 requires the use of ferrite materials. Lower cost iron powder cores may be used, but the increase in core loss reduces the efficiency of the power supply. This is especially noticeable at low output power. The winding resistance decreases efficiency at the higher output current levels. The winding resistance must be minimized, although this usually comes at the expense of a larger inductor. The power dissipated in the inductor is equal to the sum of the core and copper losses. At higher output loads, the core losses are usually insignificant and can be ignored. At lower output currents, the core losses can be significant. Core loss information is usually available from the magnetics vendor.

The amount of copper loss in the inductor is calculated by [Equation 5-12](#):

## EQUATION 5-12:

$$P_{INDUCTOR(CU)} = I_{L(RMS)}^2 \times R_{WINDING}$$

# MIC2125/6

## 5.4 Output Capacitor Selection

The type of the output capacitor is usually determined by its equivalent series resistance (ESR). Voltage and RMS current capability are two other important factors for selecting the output capacitor. Recommended capacitor types are ceramic, tantalum, low-ESR aluminum electrolytic, OS-CON, and POSCAP. The output capacitor's ESR is usually the main cause of the output ripple. The output capacitor ESR also affects the control loop from a stability point of view. The maximum value of ESR is calculated by [Equation 5-13](#).

### EQUATION 5-13:

$$ESR_{C_{OUT}} \leq \frac{\Delta V_{OUT(PP)}}{\Delta I_{L(PP)}}$$

Where:

$\Delta V_{OUT(PP)}$  Peak-to-Peak Output Voltage Ripple  
 $\Delta I_{L(PP)}$  Peak-to-Peak Inductor Current Ripple

The required output capacitance is calculated in [Equation 5-14](#).

### EQUATION 5-14:

$$C_{OUT} = \frac{\Delta I_{L(PP)}}{\Delta V_{OUT(PP)} \times f_{SW} \times 8}$$

Where:

$C_{OUT}$  Output Capacitance Value  
 $f_{SW}$  Switching Frequency

As described in the [Theory of Operation](#) subsection of the [Functional Description](#), the MIC2125/26 requires at least 20 mV peak-to-peak ripple at the FB pin to ensure that the  $g_m$  amplifier and the comparator behave properly. Also, the output voltage ripple should be in phase with the inductor current. Therefore, the output voltage ripple caused by the output capacitors value should be much smaller than the ripple caused by the output capacitor ESR. If low-ESR capacitors, such as ceramic capacitors, are selected as the output capacitors, a ripple injection method should be applied to provide the enough feedback voltage ripple. Refer to the [Ripple Injection](#) subsection for details.

The voltage rating of the capacitor should be twice the output voltage for a tantalum and 20% greater for aluminum electrolytic or OS-CON. The output capacitor RMS current is calculated in [Equation 5-15](#).

### EQUATION 5-15:

$$I_{C_{OUT}(RMS)} = \frac{\Delta I_{L(PP)}}{\sqrt{12}}$$

The power dissipated in the output capacitor is:

### EQUATION 5-16:

$$P_{DISS(COUT)} = I_{COUT(RMS)}^2 \times ESR_{COUT}$$

## 5.5 Input Capacitor Selection

The input capacitor reduces peak current drawn from the power supply and reduces noise and voltage ripple on the input. The input voltage ripple depends on the input capacitance and ESR. The input capacitance and ESR values are calculated by using [Equation 5-17](#) and [Equation 5-18](#).

### EQUATION 5-17:

$$C_{IN} = \frac{I_{OUT} \times D \times (1 - D)}{\eta \times \Delta V_{IN(C)} \times f_{SW}}$$

Where:

$I_{OUT}$  Load Current  
 $\eta$  Power Conversion Efficiency  
 $\Delta V_{IN(C)}$  Input Ripple Due to Capacitance Value

### EQUATION 5-18:

$$ESR_{CIN} = \frac{\Delta V_{IN(ESR)}}{I_{L(PK)}}$$

Where:

$\Delta V_{IN(ESR)}$  Input Ripple Due to Capacitor ESR Value  
 $I_{L(PK)}$  Peak Inductor Current

The input capacitor should be qualified for ripple current rating and voltage rating. The RMS value of the input capacitor current is determined at the maximum output current. Assuming the peak-to-peak inductor current ripple is low:

### EQUATION 5-19:

$$I_{CIN(RMS)} \approx I_{OUT(MAX)} \times \sqrt{D \times (1 - D)}$$

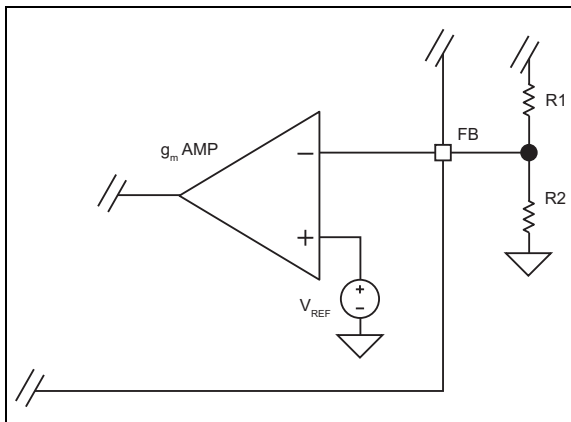
The power dissipated in the input capacitor is:

### EQUATION 5-20:

$$P_{DISS(CIN)} = I_{CIN(RMS)}^2 \times ESR_{CIN}$$

## 5.6 Output Voltage Setting

The MIC2125/26 requires two resistors to set the output voltage, as shown in [Figure 5-3](#).



**FIGURE 5-3:** Voltage-Divider Configuration.

The output voltage is determined by [Equation 5-21](#):

### EQUATION 5-21:

$$V_{OUT} = V_{FB} \times \left(1 + \frac{R1}{R2}\right)$$

Where:

$V_{FB}$	0.6V
----------	------

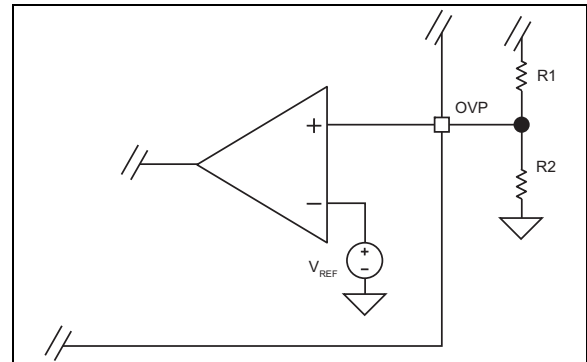
A typical value of R1 can be in the range of 3 kΩ and 15 kΩ. If R1 is too large, it may allow noise to be introduced into the voltage feedback loop. If R1 is too small in value, it will decrease the efficiency of the power supply, especially at light loads. Once R1 is selected, R2 can be calculated using [Equation 5-22](#).

### EQUATION 5-22:

$$R2 = \frac{V_{FB} \times R1}{V_{OUT} - V_{FB}}$$

## 5.7 Output Overvoltage Limit Setting

The output overvoltage limit should be typically 20% higher than the nominal output voltage. Set the OVP limit by connecting a resistor divider from the output to ground as shown in [Figure 5-4](#).



**FIGURE 5-4:** OVP Voltage-Divider Configuration.

Choose R2 in the range of 10 kΩ to 49.9 kΩ and calculate R1 using [Equation 5-23](#).

### EQUATION 5-23:

$$R1 = R2 \left[ \frac{V_{OVP}}{0.6} - 1 \right]$$

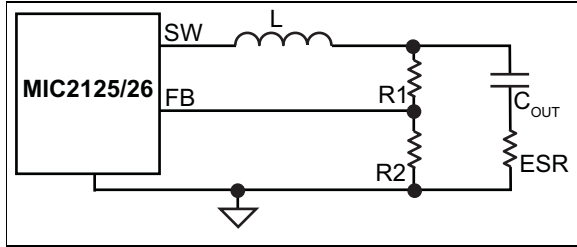
## 5.8 Ripple Injection

The  $V_{FB}$  ripple required for proper operation of the MIC2125/6  $g_m$  amplifier and comparator is 20 mV to 100 mV. However, the output voltage ripple is generally designed as 1% to 2% of the output voltage. For low output voltages, such as a 1V, the output voltage ripple is only 10 mV to 20 mV, and the feedback voltage ripple is less than 20 mV. If the feedback voltage ripple is so small that the  $g_m$  amplifier and comparator cannot sense it, then the MIC2125/6 loses control and the output voltage is not regulated. In order to have sufficient  $V_{FB}$  ripple, a ripple injection method should be applied for low output voltage ripple applications.

The applications are divided into three situations according to the amount of the feedback voltage ripple:

- Enough ripple at the feedback voltage due to the large ESR of the output capacitors ([Figure 5-5](#)). The converter is stable without any ripple injection.

# MIC2125/6



**FIGURE 5-5:** Enough Ripple at FB.

The feedback voltage ripple is:

**EQUATION 5-24:**

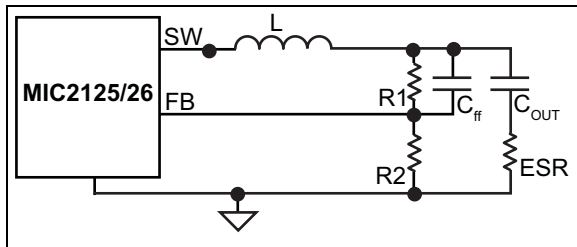
$$\Delta V_{FB(PP)} = \frac{R2}{R1 + R2} \times ESR_{C_{OUT}} \times \Delta I_{L(PP)}$$

Where:

$\Delta I_{L(PP)}$  Peak-to-Peak Value of the Inductor Current Ripple

- Inadequate ripple at the feedback voltage due to the small ESR of the output capacitors.

The output voltage ripple is fed into the FB pin through a feed-forward capacitor,  $C_{ff}$  in this situation, as shown in Figure 5-7. The typical  $C_{ff}$  value is between 1 nF and 100 nF.



**FIGURE 5-6:** Inadequate Ripple at FB.

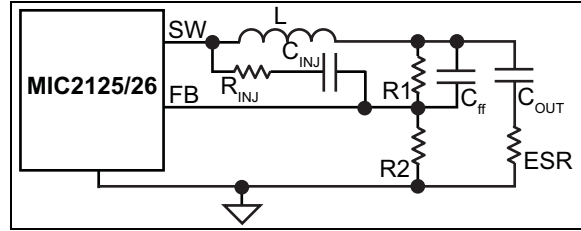
With the feed-forward capacitor, the feedback voltage ripple is very close to the output voltage ripple.

**EQUATION 5-25:**

$$\Delta V_{FB(PP)} \approx ESR \times \Delta I_{L(PP)}$$

- Virtually no ripple at the FB pin voltage due to the very low ESR of the output capacitors.

Therefore, additional ripple is injected into the FB pin from the switching node SW via a resistor  $R_{INJ}$  and a capacitor  $C_{INJ}$ , as shown in Figure 5-7.



**FIGURE 5-7:** Invisible Ripple at FB.

The process of sizing the ripple injection resistor and capacitors is as follows.

- Select  $C_{INJ}$  as 100 nF, which can be considered as short for a wide range of the frequencies.
- Select  $C_{ff}$  to feed all output ripples into the feedback pin. Typical choice of  $C_{ff}$  is 0.47 nF to 47 nF, if R1 and R2 are in the kΩ range. The  $C_{ff}$  value can be calculated using Equation 5-26:

**EQUATION 5-26:**

$$C_{ff} \gg \frac{1}{R_p} \times \left( \frac{t_s \times V_{IN} \times D \times (1 - D)}{(V_{IN} \times D \times (1 - D)) - \Delta V_{FB(PP)}} \right)$$

Where:

$V_{IN}$  Power Stage Input Voltage  
 $D$  Duty Cycle  
 $t_s$   $1/f_{SW}$   
 $R_p$   $(R1//R2//R_{INJ})$   
 $\Delta V_{FB(PP)}$  Feedback Ripple

- Select  $R_{INJ}$  according to Equation 5-27.

**EQUATION 5-27:**

$$R_{INJ} = \frac{1}{C_{ff}} \times \left( \frac{V_{IN} \times D \times (1 - D)}{\Delta V_{FB(PP)} \times f_{SW}} \right)$$



## 6.0 PCB LAYOUT GUIDELINES

PCB layout is critical to achieve reliable, stable and efficient performance. The following guidelines should be followed to ensure proper operation of the MIC2125/26 converter.

### 6.1 IC

- The ceramic bypass capacitors which are connected to the  $V_{DD}$  and  $P_{VDD}$  pins must be located right at the IC. Use wide traces to connect to the  $V_{DD}$ ,  $P_{VDD}$  and  $A_{GND}$ ,  $P_{GND}$  pins respectively.
- The signal ground pin ( $A_{GND}$ ) must be connected directly to the ground planes.
- Place the IC close to the point-of-load (POL).
- Signal and power grounds should be kept separate and connected at only one location.

### 6.2 Input Capacitor

- Place the input ceramic capacitors as close as possible to the MOSFETs.
- Place several vias to the ground plane close to the input capacitor ground terminal.

### 6.3 Inductor

- Keep the inductor connection to the switch node (SW) short.
- Do not route any digital lines underneath or close to the inductor.
- Keep the switch node (SW) away from the feedback (FB) pin.
- The SW pin should be connected directly to the drain of the low-side MOSFET to accurately sense the voltage across the low-side MOSFET.

### 6.4 Output Capacitor

- Use a copper plane to connect the output capacitor ground terminal to the input capacitor ground terminal.
- The feedback trace should be separate from the power trace and connected as close as possible to the output capacitor. Sensing a long high-current load trace can degrade the DC load regulation.

### 6.5 MOSFETs

- MOSFET gate drive traces must be short. The ground plane should be the connection between the MOSFET source and  $P_{GND}$ .
- Choose a low-side MOSFET with a high  $C_{GS}/C_{GD}$  ratio and a low internal gate resistance to minimize the effect of  $d_v/d_t$  inducted turn-on.
- Use a 4.5V  $V_{GS}$  rated MOSFET. Its higher gate threshold voltage is more immune to glitches than a 2.5V or 3.3V rated MOSFET.

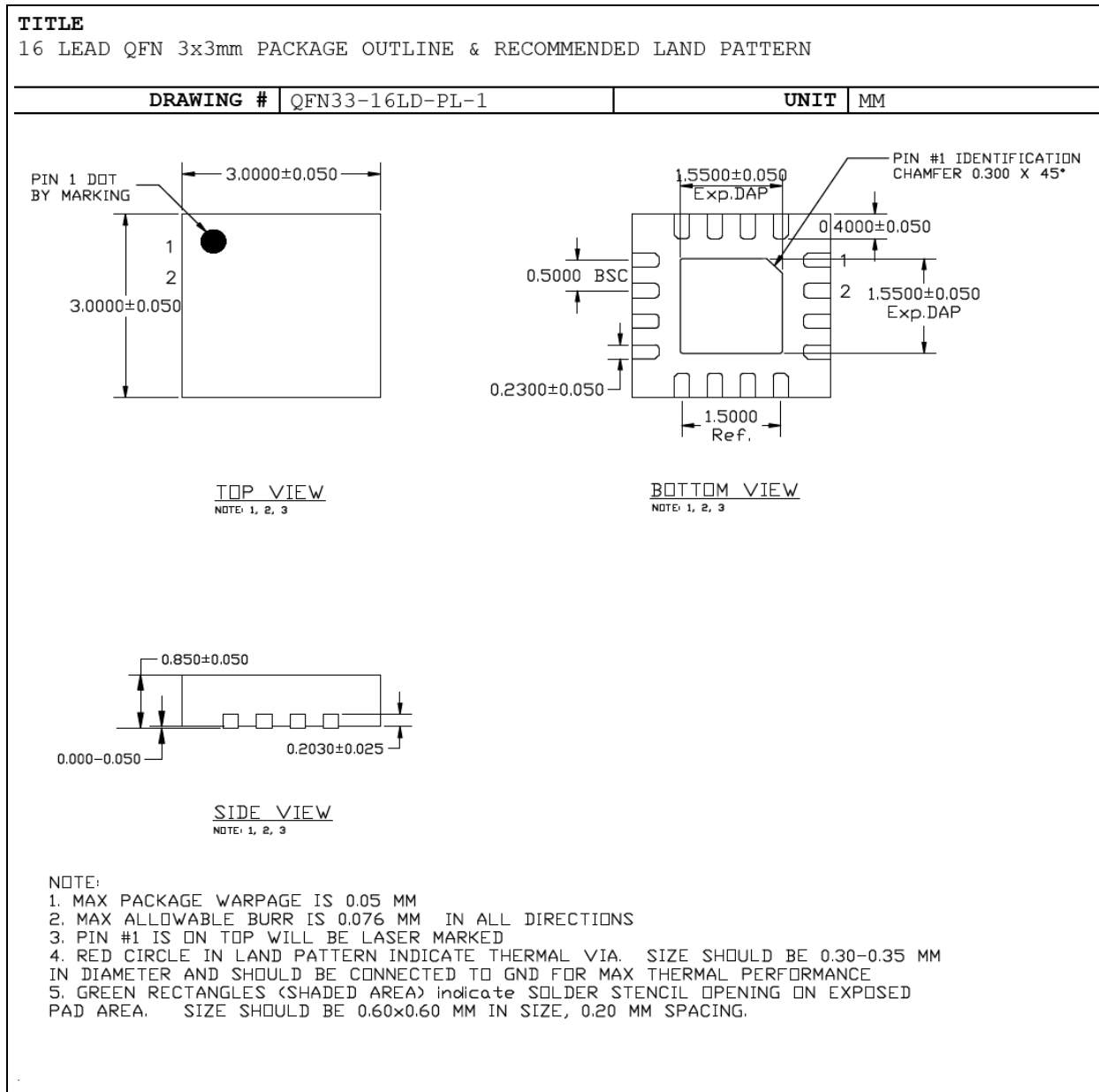
For more information about the Evaluation board layout, please contact Microchip sales.

# MIC2125/6

## 7.0 PACKAGING INFORMATION

### 16-Lead QFN 3 mm x 3 mm Package Outline and Recommended Land Pattern

**Note:** For the most current package drawings, please see the Microchip Packaging Specification located at <http://www.microchip.com/packaging>

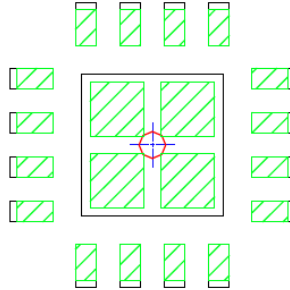


**Note:** For the most current package drawings, please see the Microchip Packaging Specification located at <http://www.microchip.com/packaging>

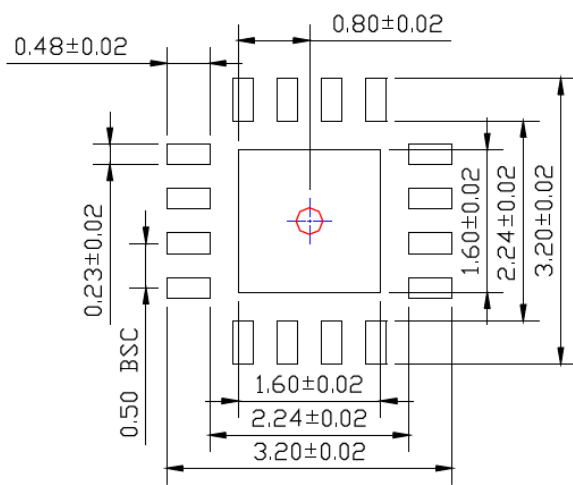
## POD-Land Pattern drawing # QFN33-16LD-PL-1

### RECOMMENDED LAND PATTERN

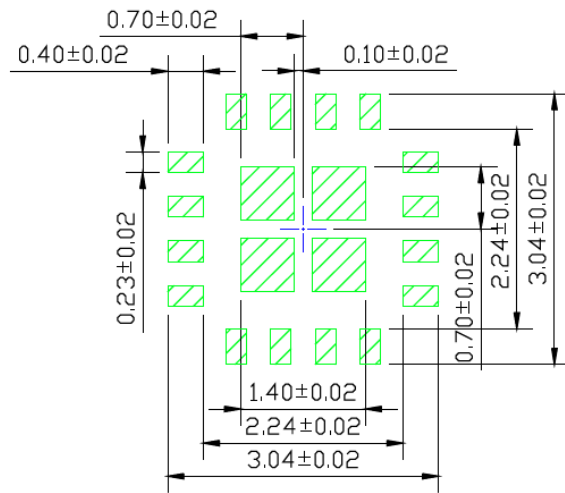
NOTE: 4, 5



STACKED-UP



EXPOSED METAL TRACE



SOLDER STENCIL OPENING



## APPENDIX A: REVISION HISTORY

### Revision A (November 2015)

- Original Conversion of this Document.

### Revision B (December 2015)

- Corrected the erroneous listing of the MIC2126 example with a 64LD package. Replaced with correct 16LD package information.

# MIC2125/6

---

NOTES:

## PRODUCT IDENTIFICATION SYSTEM

To order or obtain information, e.g., on pricing or delivery, contact your local Microchip representative or sales office.

<u>PART NO.</u>		<u>X</u>	<u>XX</u>
		Device	Temperature Package
<b>Device:</b>	MIC2125:	28V, Synchronous Buck Controller featuring Adaptive On-Time Control with HyperLight Load	
	MIC2126:	28V, Synchronous Buck Controller featuring Adaptive On-Time Control with Hyper Speed Control	
<b>Temperature:</b>	Y =	-40°C to +125°C	
<b>Package:</b>	ML =	16-Pin 3 mm x 3 mm QFN	

<b>Examples:</b>	
a) MIC2125YML:	28V, Synchronous Buck Controller featuring Adaptive On-Time Control with HyperLight Load, -40°C to +125°C junction temperature range, 16LD QFN
b) MIC2126YML:	28V, Synchronous Buck Controller featuring Adaptive On-Time Control with Hyper Speed Control, -40°C to +125°C junction temperature range, 16LD QFN

# MIC2125/6

---

NOTES:



---

**Note the following details of the code protection feature on Microchip devices:**

- Microchip products meet the specification contained in their particular Microchip Data Sheet.
- Microchip believes that its family of products is one of the most secure families of its kind on the market today, when used in the intended manner and under normal conditions.
- There are dishonest and possibly illegal methods used to breach the code protection feature. All of these methods, to our knowledge, require using the Microchip products in a manner outside the operating specifications contained in Microchip's Data Sheets. Most likely, the person doing so is engaged in theft of intellectual property.
- Microchip is willing to work with the customer who is concerned about the integrity of their code.
- Neither Microchip nor any other semiconductor manufacturer can guarantee the security of their code. Code protection does not mean that we are guaranteeing the product as “unbreakable.”

Code protection is constantly evolving. We at Microchip are committed to continuously improving the code protection features of our products. Attempts to break Microchip's code protection feature may be a violation of the Digital Millennium Copyright Act. If such acts allow unauthorized access to your software or other copyrighted work, you may have a right to sue for relief under that Act.

---

Information contained in this publication regarding device applications and the like is provided only for your convenience and may be superseded by updates. It is your responsibility to ensure that your application meets with your specifications. MICROCHIP MAKES NO REPRESENTATIONS OR WARRANTIES OF ANY KIND WHETHER EXPRESS OR IMPLIED, WRITTEN OR ORAL, STATUTORY OR OTHERWISE, RELATED TO THE INFORMATION, INCLUDING BUT NOT LIMITED TO ITS CONDITION, QUALITY, PERFORMANCE, MERCHANTABILITY OR FITNESS FOR PURPOSE. Microchip disclaims all liability arising from this information and its use. Use of Microchip devices in life support and/or safety applications is entirely at the buyer's risk, and the buyer agrees to defend, indemnify and hold harmless Microchip from any and all damages, claims, suits, or expenses resulting from such use. No licenses are conveyed, implicitly or otherwise, under any Microchip intellectual property rights unless otherwise stated.

#### **Trademarks**

The Microchip name and logo, the Microchip logo, dsPIC, FlashFlex, flexPWR, JukeBlox, KEELOQ, KEELOQ logo, Klear, LANCheck, MediaLB, MOST, MOST logo, MPLAB, OptoLyzer, PIC, PICSTART, PIC<sup>32</sup> logo, RightTouch, SpyNIC, SST, SST Logo, SuperFlash and UNI/O are registered trademarks of Microchip Technology Incorporated in the U.S.A. and other countries.

The Embedded Control Solutions Company and mTouch are registered trademarks of Microchip Technology Incorporated in the U.S.A.

Analog-for-the-Digital Age, BodyCom, chipKIT, chipKIT logo, CodeGuard, dsPICDEM, dsPICDEM.net, ECAN, In-Circuit Serial Programming, ICSP, Inter-Chip Connectivity, KlearNet, KlearNet logo, MiWi, motorBench, MPASM, MPF, MPLAB Certified logo, MPLIB, MPLINK, MultiTRAK, NetDetach, Omniscient Code Generation, PICDEM, PICDEM.net, PICKit, PICTail, RightTouch logo, REAL ICE, SQI, Serial Quad I/O, Total Endurance, TSHARC, USBCheck, VariSense, ViewSpan, WiperLock, Wireless DNA, and ZENA are trademarks of Microchip Technology Incorporated in the U.S.A. and other countries.

SQTP is a service mark of Microchip Technology Incorporated in the U.S.A.

Silicon Storage Technology is a registered trademark of Microchip Technology Inc. in other countries.

GestIC is a registered trademark of Microchip Technology Germany II GmbH & Co. KG, a subsidiary of Microchip Technology Inc., in other countries.

All other trademarks mentioned herein are property of their respective companies.

© 2015, Microchip Technology Incorporated, Printed in the U.S.A., All Rights Reserved.

ISBN: 978-1-5224-0039-4

**QUALITY MANAGEMENT SYSTEM**  
**CERTIFIED BY DNV**  
**== ISO/TS 16949 ==**

*Microchip received ISO/TS-16949:2009 certification for its worldwide headquarters, design and wafer fabrication facilities in Chandler and Tempe, Arizona; Gresham, Oregon and design centers in California and India. The Company's quality system processes and procedures are for its PIC<sup>®</sup> MCUs and dsPIC<sup>®</sup> DSCs, KEELOQ<sup>®</sup> code hopping devices, Serial EEPROMs, microperipherals, nonvolatile memory and analog products. In addition, Microchip's quality system for the design and manufacture of development systems is ISO 9001:2000 certified.*



**MICROCHIP**

## Worldwide Sales and Service

### AMERICAS

**Corporate Office**  
2355 West Chandler Blvd.  
Chandler, AZ 85224-6199  
Tel: 480-792-7200  
Fax: 480-792-7277  
Technical Support:  
[http://www.microchip.com/  
support](http://www.microchip.com/support)  
Web Address:  
[www.microchip.com](http://www.microchip.com)

**Atlanta**  
Duluth, GA  
Tel: 678-957-9614  
Fax: 678-957-1455

**Austin, TX**  
Tel: 512-257-3370

**Boston**  
Westborough, MA  
Tel: 774-760-0087  
Fax: 774-760-0088

**Chicago**  
Itasca, IL  
Tel: 630-285-0071  
Fax: 630-285-0075

**Cleveland**  
Independence, OH  
Tel: 216-447-0464  
Fax: 216-447-0643

**Dallas**  
Addison, TX  
Tel: 972-818-7423  
Fax: 972-818-2924

**Detroit**  
Novi, MI  
Tel: 248-848-4000

**Houston, TX**  
Tel: 281-894-5983

**Indianapolis**  
Noblesville, IN  
Tel: 317-773-8323  
Fax: 317-773-5453

**Los Angeles**  
Mission Viejo, CA  
Tel: 949-462-9523  
Fax: 949-462-9608

**New York, NY**  
Tel: 631-435-6000

**San Jose, CA**  
Tel: 408-735-9110

**Canada - Toronto**  
Tel: 905-673-0699  
Fax: 905-673-6509

### ASIA/PACIFIC

**Asia Pacific Office**  
Suites 3707-14, 37th Floor  
Tower 6, The Gateway  
Harbour City, Kowloon

**Hong Kong**  
Tel: 852-2943-5100  
Fax: 852-2401-3431

**Australia - Sydney**  
Tel: 61-2-9868-6733  
Fax: 61-2-9868-6755

**China - Beijing**  
Tel: 86-10-8569-7000  
Fax: 86-10-8528-2104

**China - Chengdu**  
Tel: 86-28-8665-5511  
Fax: 86-28-8665-7889

**China - Chongqing**  
Tel: 86-23-8980-9588  
Fax: 86-23-8980-9500

**China - Dongguan**  
Tel: 86-769-8702-9880

**China - Hangzhou**  
Tel: 86-571-8792-8115  
Fax: 86-571-8792-8116

**China - Hong Kong SAR**  
Tel: 852-2943-5100  
Fax: 852-2401-3431

**China - Nanjing**  
Tel: 86-25-8473-2460  
Fax: 86-25-8473-2470

**China - Qingdao**  
Tel: 86-532-8502-7355  
Fax: 86-532-8502-7205

**China - Shanghai**  
Tel: 86-21-5407-5533  
Fax: 86-21-5407-5066

**China - Shenyang**  
Tel: 86-24-2334-2829  
Fax: 86-24-2334-2393

**China - Shenzhen**  
Tel: 86-755-8864-2200  
Fax: 86-755-8203-1760

**China - Wuhan**  
Tel: 86-27-5980-5300  
Fax: 86-27-5980-5118

**China - Xian**  
Tel: 86-29-8833-7252  
Fax: 86-29-8833-7256

### ASIA/PACIFIC

**China - Xiamen**  
Tel: 86-592-2388138  
Fax: 86-592-2388130

**China - Zhuhai**  
Tel: 86-756-3210040  
Fax: 86-756-3210049

**India - Bangalore**  
Tel: 91-80-3090-4444  
Fax: 91-80-3090-4123

**India - New Delhi**  
Tel: 91-11-4160-8631  
Fax: 91-11-4160-8632

**India - Pune**  
Tel: 91-20-3019-1500

**Japan - Osaka**  
Tel: 81-6-6152-7160  
Fax: 81-6-6152-9310

**Japan - Tokyo**  
Tel: 81-3-6880-3770  
Fax: 81-3-6880-3771

**Korea - Daegu**  
Tel: 82-53-744-4301  
Fax: 82-53-744-4302

**Korea - Seoul**  
Tel: 82-2-554-7200  
Fax: 82-2-558-5932 or  
82-2-558-5934

**Malaysia - Kuala Lumpur**  
Tel: 60-3-6201-9857  
Fax: 60-3-6201-9859

**Malaysia - Penang**  
Tel: 60-4-227-8870  
Fax: 60-4-227-4068

**Philippines - Manila**  
Tel: 63-2-634-9065  
Fax: 63-2-634-9069

**Singapore**  
Tel: 65-6334-8870  
Fax: 65-6334-8850

**Taiwan - Hsin Chu**  
Tel: 886-3-5778-366  
Fax: 886-3-5770-955

**Taiwan - Kaohsiung**  
Tel: 886-7-213-7828

**Taiwan - Taipei**  
Tel: 886-2-2508-8600  
Fax: 886-2-2508-0102

**Thailand - Bangkok**  
Tel: 66-2-694-1351  
Fax: 66-2-694-1350

### EUROPE

**Austria - Wels**  
Tel: 43-7242-2244-39  
Fax: 43-7242-2244-393

**Denmark - Copenhagen**  
Tel: 45-4450-2828  
Fax: 45-4485-2829

**France - Paris**  
Tel: 33-1-69-53-63-20  
Fax: 33-1-69-30-90-79

**Germany - Dusseldorf**  
Tel: 49-2129-3766400

**Germany - Karlsruhe**  
Tel: 49-721-625370

**Germany - Munich**  
Tel: 49-89-627-144-0  
Fax: 49-89-627-144-44

**Italy - Milan**  
Tel: 39-0331-742611  
Fax: 39-0331-466781

**Italy - Venice**  
Tel: 39-049-7625286

**Netherlands - Drunen**  
Tel: 31-416-690399  
Fax: 31-416-690340

**Poland - Warsaw**  
Tel: 48-22-3325737  
Fax: 48-22-3325737

**Spain - Madrid**  
Tel: 34-91-708-08-90  
Fax: 34-91-708-08-91

**Sweden - Stockholm**  
Tel: 46-8-5090-4654

**UK - Wokingham**  
Tel: 44-118-921-5800  
Fax: 44-118-921-5820

07/14/15