



PART NUMBER: GC0351P-1

DESCRIPTION: speaker

SPECIFICATIONS

nominal size	16 x 35 mm		
impedance	4 Ohm \pm 15%	at	1.2 KHz 2 V
resonant frequency	630 Hz \pm 126 Hz	at	2 V
sound pressure level	82 dB/w \pm 3 dB	1 w 50 cm ave. at 0.6K, 0.8K, 1K, 1.2K Hz	
response	Fo Hz ~ 13 KHz max 10 dB		
input power	nominal 1 W	handling capacity	2 W
operation	must be normal at program source 1 W		
buzz, rattle, etc.	must be normal at sine wave 2 V		
magnet	size: 8.1 x 1.4 mm		
load test	white noise 1 W	for	24 hours
heat test	65 \pm 2° C	20-50% R.H.	24 hours
humidity test	40 \pm 2° C	90-95% R.H.	24 hours

FREQUENCY RESPONSE CURVE

potentiometer range	50 dB
rectifier	RMS
lower limit frequency	20 Hz
wr. speed	100 mm/sec

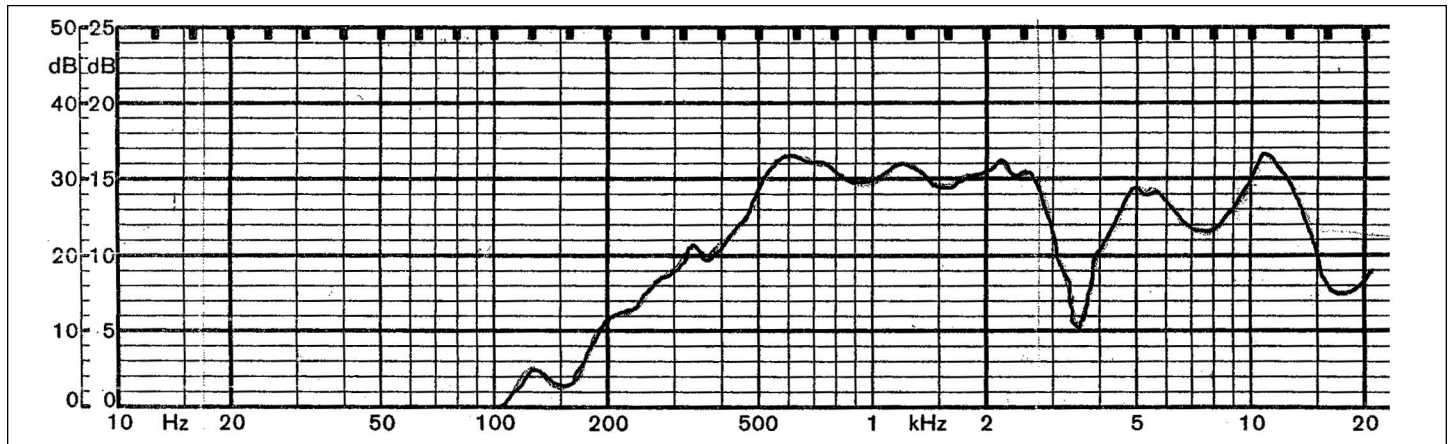

zero level 50 dB

REV.	DESCRIPTION	DATE
A	NEW DRAWING	6/4/2007

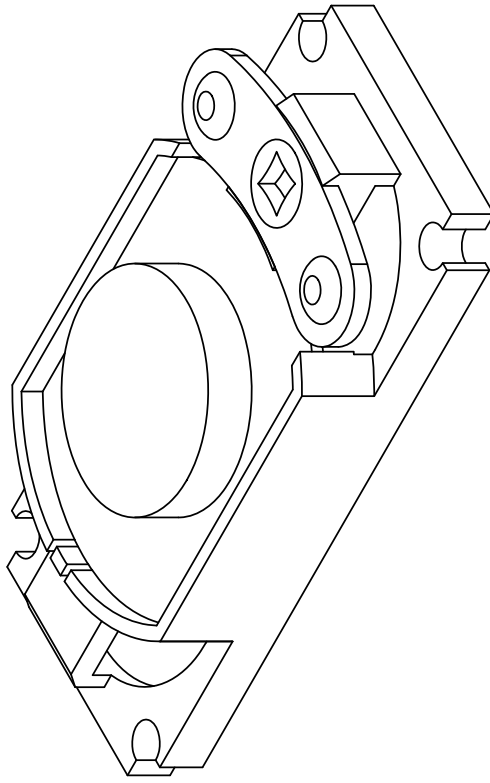
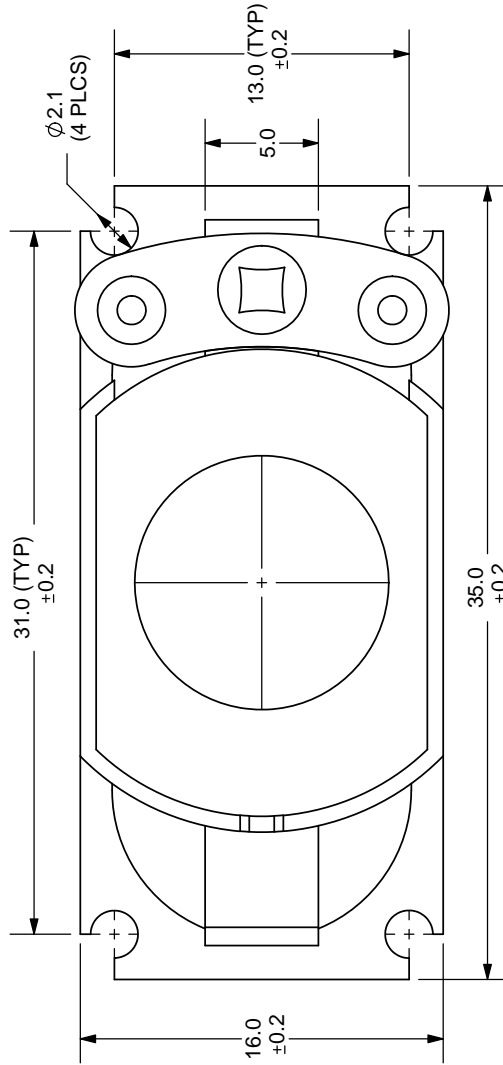
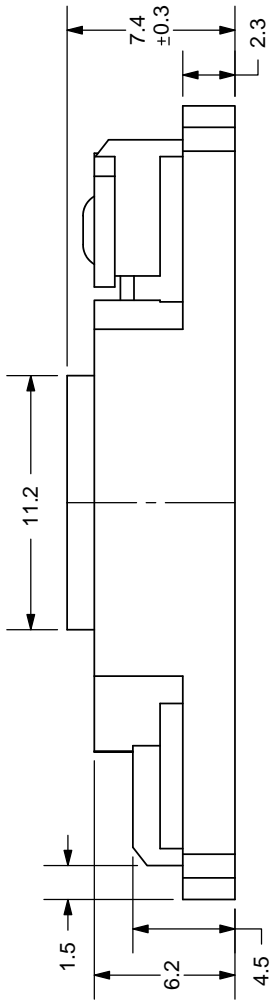

TOLERANCE:
±0.5mm UNLESS OTHERWISE
SPECIFIED



CUI INC

20050 SW 112th Ave.
Tualatin, OR 97062
Phone: 503-612-2300
800-275-4899
Fax: 503-612-2383
Website: www.cui.com

TITLE: LOW PROFILE NOTEBOOK SPEAKER REV: A

PART NO: GC0351P-1 UNITS: MM [INCHES]

DRAWN BY: ZRJ APPROVED BY: SCALE: 3:1