

Ordering Information

Appearance	Item	Measured particle diameter	Model
	Air Particle Sensor Particle measurement type	0.3, 0.5, or 1.0 μm min.	ZN-PD03-S
	Air Particle Sensor Dust measurement type	5μm(10μm), 20μm(30μm), 50μm min. () is selectable.	ZN-PD50-S

PC Software

Appearance	Item	Model
	Wave Inspire ES	ZN-SW11-S

System Requirements OS: Windows XP, Windows Vista
CPU: Compatible with Intel processors, 1GHz or higher
Memory: 1GB or more (2GB or more recommended)

Accessories(Order Separately)

Appearance	Item	Model
	Change filter set for Particle measurement type	ZN9-PF1-S
	Change filter set for Dust measurement type	ZN9-PF2-S
	Exhaust tube(4m)	ZN9-PT4-S
	Exhaust tube(8m)	ZN9-PT8-S
	Filter for cleaning	ZN9-PC1-S

Specifications

Item	Model	Particle measurement type	Dust measurement type
		ZN-PD03-S	ZN-PD50-S
Measurement method	90° sideways light-scattering method		
Light source	Semiconductor laser		
Measured particle diameter	0.3, 0.5, or 1.0 μm min. 5μm(10μm), 20μm(30μm), 50μm min.(See note 1.)		
Particle concentration	0 to 100,000particles/cf 0 to 50,000particles/cf		
Sample flow rate	≥2.8Litter/min ≥6.0Litter/min		
Status outputs(2 outputs)	Photo coupler output		
System error status output	(Status outputs linked with clean levels)		
Trigger Input	Photo coupler input		
Communication interface	Ethernet twisted-pair cable connector (TCP/IP)		
Indicators	Clean Levels:4levels(adjustable) 7-segment main display (red/6digits):Count value (Selectable particles/cf, particles/Litter, counts of particles per measurement time) 7-segment sub-display(green/6 digits):Selected particle diameter		
Measure Mode	Real-time mode (by second)/Cycle mode(by set cycle)/Trigger mode(by trigger)		
Power supply voltage	DC19V (See note 2.)		
Current consumption	1A MAX		
Ambient temperature range	Operating: 0 to 35° C Operating: 0 to 40° C Storage: -15 to 50° C (with no icing or condensation)		
Ambient humidity range	Operating and storage: 35% to 85% (with no icing or condensation)		
Insulation resistance	20 MΩ min. at 500 VDC		
Withstand voltage	1,000 VAC, 50/60 Hz for 1 min		
Vibration resistance	110 to 55 Hz, 0.3-mm double amplitude, 50 min		
Materials	ABS		
Degree of protection	IP20		
Installation method	DIN track mount / Self standing		
Weight (Packed state)	Approx.1.7kg		
Accessories	Instruction Sheet, AC adaptor		
	Air-intake tube(Tubing ID: Φ10mm, Length 1m)x1	Air filter x1	

Note 1. () is selectable.
Note 2. Must be used with specified AC adaptor.

Dimensions

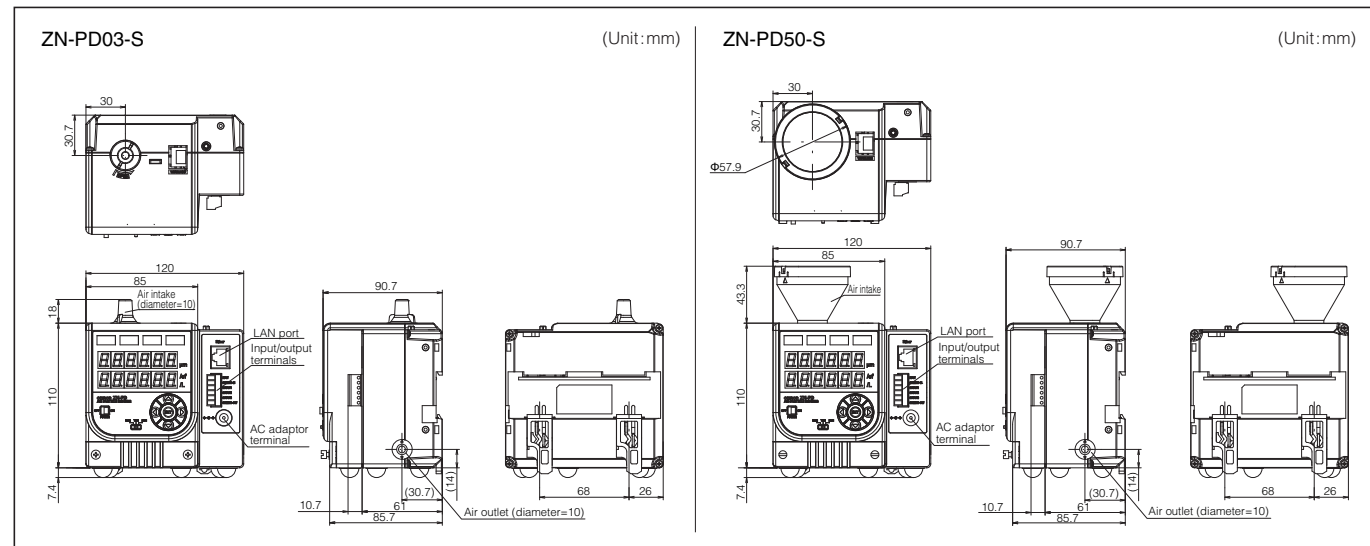

New

Production-Environmental
Sensing Series **The First**

Air Particle Sensor ZN-PD-S

Cost Effective and Wide range measurement size
(From Particle to Dust)

Optimized Quality Management with Real-time Particle Monitoring System



Particle measurement type
(0.3μm to 1μm)

Dust measurement type
(5μm to 50μm)

OMRON Corporation
Industrial Automation Company
Sensing Devices Division H.Q.
Growth Industry Promotion Dept.
Shiokoji Horikawa, Shimogyo-ku,
Kyoto, 600-8530 Japan
Tel: (81) 75-344-7211/Fax: (81) 75-344-7107

Regional Headquarters
OMRON EUROPE B.V.
Sensor Business Unit
Carl-Benz-Str. 4, D-71154 Nufringen,
Germany
Tel: (49) 7032-811-0/Fax: (49) 7032-811-199

OMRON ELECTRONICS LLC
One Commerce Drive Schaumburg,
IL 60173-5302 U.S.A.
Tel: (1) 847-843-7900/Fax: (1) 847-843-7787

OMRON ASIA PACIFIC PTE. LTD.
No. 438A Alexandra Road # 05-05/08 (Lobby 2),
Alexandra Technopark, Singapore 119967
Tel: (65) 6835-3011/Fax: (65) 6835-2711

OMRON (CHINA) CO., LTD.
Room 2211, Bank of China Tower,
200 Yin Cheng Zhong Road,
PuDong New Area, Shanghai, 200120, China
Tel: (86) 21-5037-2222/Fax: (86) 21-5037-2200

Authorized Distributor:

© OMRON Corporation 2008 All Rights Reserved.
In the interest of product improvement,
specifications are subject to change without notice.

Particle/contamination Real-time Monitoring

Thinking of upgrading from manual fixed-point particle measurement in your clean environment to a continuous monitoring solution?

The ZN-PD03-S Particle Sensor (Particle Type) provides continuous high-precision monitoring at a very low set-up cost.

It is ideal for traceability and fault analysis and substantially reduces labor expenses.

Combines high-precision measurement with continuous monitoring

Measurement accuracy to rival a particle counter? **Top In Class**

The Particle Sensor generates air flow of 2.83 liters per minute through a combination of fully rectified internal design and high-suction fan. Measurement accuracy is close to that of a particle counter, thanks to Omron laser-optic design technology as used in high-precision displacement sensors.



Intake air is irradiated with laser light and the level of scattered light from particles is measured.

Typical air cleanliness readings from different types of measuring devices

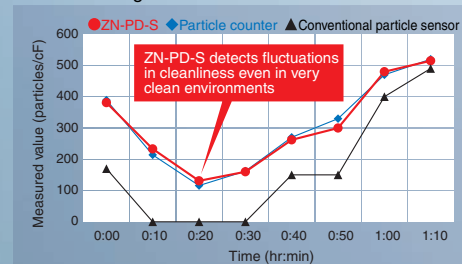

Cleanliness levels varied in a CLASS 100 (approx.) environment using FFU air flow control.
Particle sensor measurements taken via scaling.

Low-maintenance design for continuous measurement

The maintenance workload is reduced substantially through a combination of long-lasting fan construction and intermittent laser mode designed to prolong the life span of the laser. Maintenance costs are also much lower since the Particle Sensor does not need an external pump which tends to require frequent replacement.

Examples of use



Multi-point continuous monitoring in clean room

Trend monitoring of manufacturing equipment

Measurement data is used for trend analysis and early detection of problems

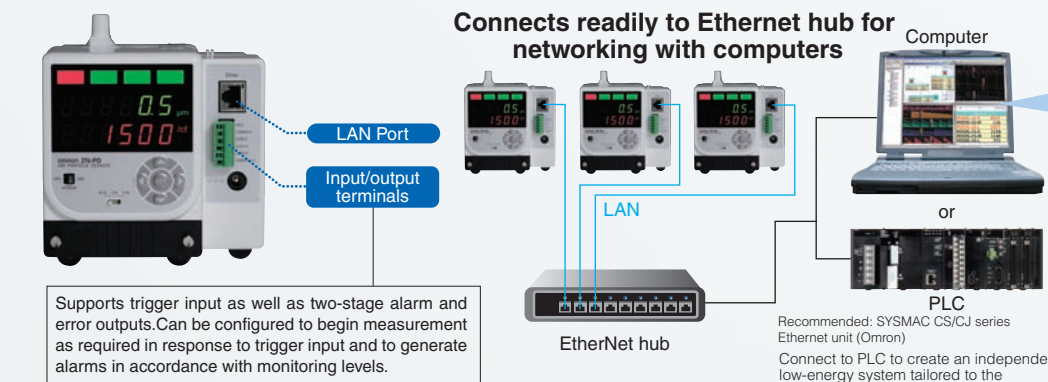

Production-Environments Visualizer (PC software)

Wave Inspire ES

(Option) Model ZN-SW11-S

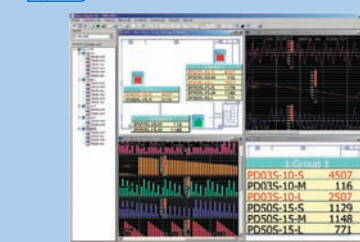

Visual representation of particle volumes makes it easier to identify trends for faster analysis! Also handles time-consuming tasks such as data storage and collation.

Real-time analysis of measurement data

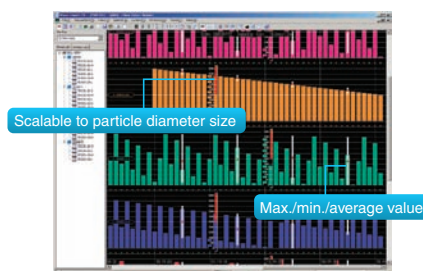

Shows hourly and daily trends at a glance-ideal for early detection of problems.

Diagram layout of equipment and measuring devices

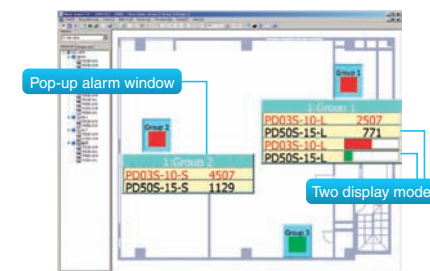

Pop-up windows provide immediate notification of alarms to enable a rapid response.

Convert selected data to Excel format

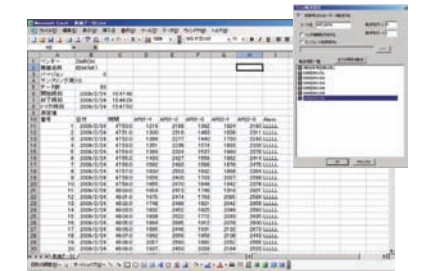

Select required log data and convert to CSV file format. Direct import into Excel file format is also available.

Optimized Quality Management with Two valuable Models!

ALL NEW

Ambient Dust Real-time Monitoring

Foreign matter in the production environment can affect the quality of finished products. Perhaps your production environment is affected by dust? The largest form of particles, typically carried by human operators and generated by machinery.

The ZN-PD50-S Particle Sensor (Dust measurement type) provides the most simple and effective solution yet for monitoring dust levels.

Measure dust levels and identify dust sources with a single unit

Efficient measurement of falling dust

The combination of a powerful fan and a funnel-shaped air intake efficiently captures falling dust. A built-in filter prevents large dust particles from entering the system and causing internal blockages. The filter is simple to replace.



Filter

Dust Catcher feature to identify dust sources

Double-sided tape on the pull-out Trap Box captures dust particles. The dust can then be analyzed under a microscope to determine the source.



Trap Box



Dust measurement type Model ZN-PD50-S

5(10) μ m 20(30) μ m 50 μ m
Simultaneous real-time sensing

Examples of use



Trend monitoring in cell manufacturing production line



Dust monitoring on paint process