

Description

Single, two and three pole magnetic and hydraulic-magnetic circuit breakers with trip-free mechanism and toggle actuation. A choice of fast magnetic only or hydraulically delayed switching characteristics (S-type MO or HM CBE to EN 60934) ensures suitability for a wide range of applications. Featuring a combi-foot design for symmetric rail mounting. Low temperature sensitivity at rated load. Approved to CBE standard EN 60934 (IEC 60934).

Typical applications

Power supplies, control equipment, communication systems, EDP systems.

Standard current ratings and typical internal resistance values

| Current rating (A) | Internal resistance values (Ω) per pole | | | |
|--------------------|---|--------|------------|------------|
| | F1 | F2 | K1, M1, T1 | K2, M2, T2 |
| 0,02 | 1 493 | 953 | 2 669 | 2 457 |
| 0,05 | 276 | 152 | 452 | 376 |
| 0,1 | 58 | 37 | 100 | 94 |
| 0,25 | 8,2 | 6,0 | 15,5 | 14,7 |
| 0,5 | 2,3 | 1,47 | 3,9 | 3,2 |
| 0,75 | 0,98 | 0,63 | 1,65 | 1,56 |
| 1 | 0,58 | 0,35 | 0,95 | 0,90 |
| 2 | 0,145 | 0,096 | 0,26 | 0,20 |
| 2,5 | 0,096 | 0,061 | 0,15 | 0,15 |
| 3 | 0,065 | 0,048 | 0,10 | 0,10 |
| 5 | 0,025 | < 0,02 | 0,042 | 0,040 |
| 6 | < 0,02 | < 0,02 | 0,029 | 0,028 |
| 8 | < 0,02 | < 0,02 | < 0,02 | < 0,02 |
| 10 | < 0,02 | < 0,02 | < 0,02 | < 0,02 |
| 12 | < 0,02 | < 0,02 | < 0,02 | < 0,02 |
| 15 | < 0,02 | < 0,02 | < 0,02 | < 0,02 |
| 16 | < 0,02 | < 0,02 | < 0,02 | < 0,02 |
| 20 | < 0,02 | < 0,02 | < 0,02 | < 0,02 |
| 25 | < 0,02 | < 0,02 | < 0,02 | < 0,02 |
| 30 | < 0,02 | < 0,02 | < 0,02 | < 0,02 |
| 40 | < 0,01 | - | < 0,01 | - |
| 50 | < 0,01 | - | < 0,01 | - |



single pole

8340-T...

three pole

Technical data

For further details please see chapter: Technical Information

| | | | |
|---|--|--|-----------------|
| Voltage rating | 3 AC 415V; AC 240V (50/60Hz); DC 80V (higher DC voltages to special order) | | |
| Current rating range | 0.02...50 A DC 0.02...30 A AC | | |
| Auxiliary circuit | 1 A, AC 240 V/DC 65 V; 0.5 A DC 80 V | | |
| Typical life | 3 AC 415 V AC 240 V: 0.02...30 A 6,000 operations at 1 x I _N , inductive 10,000 operations at 1 x I _N , resistive WDC 80 V: 0.02...25 A 6,000 operations at 1 x I _N , inductive 0.02...30 A 10,000 operations at 1 x I _N , resistive 40 + 50 A 6,000 operations at 1 x I _N , resistive | | |
| Ambient temperature | -40...+85 °C (-40...+185 °F) | | |
| Insulation co-ordination (IEC 60664 and 60664A) | rated impulse withstand voltage 2.5 kV reinforced insulation in operating area | pollution degree 2 | |
| Dielectric strength (IEC 60664 and 60664A) | operating area Line to Load pole to pole (2- and 3-pole) main to auxiliary circuit | test voltage AC 3,000 V test voltage AC 1,500 V test voltage AC 1,500 V test voltage AC 1,500 V | |
| Insulation resistance | > 100 MΩ (DC 500 V) | | |
| Interrupting capacity | 6 x I _N at AC; IEC 60934 - test sequence E 4 x I _N at DC | | |
| Interrupting capacity (UL 1077) | I _N | 0.02...20 A | 25...30 A |
| | AC: | 1-pole AC 250 V/3,500A | AC 250 V/3,500A |
| | | 2-pole AC 250 V/3,500A | AC 250 V/5,000A |
| | | 3-pole 3AC 250V/3,500A | 3AC250V/5,000A |
| | DC: | 1-pole 0.02...50 A | DC 80 V/3,500 A |
| | | 2-pole 0.02...30 A | DC 80 V/3500 A |
| Degree of protection (IEC 60529/DIN 40050) | operating area IP40 terminal area IP20 | | |
| Vibration | with toggle down: 10 g at 0.9 I _N directions 1, 2, 3, 4, 5: 10 g at 1 x I _N with curves F1, F2: 10 g at 0.8 x I _N in all planes. (57-2000 Hz) ± 0.76 mm (10-57 Hz) to IEC 60068-2-6, test Fc 10 frequency cycles/axis | | |
| Shock | directions 1, 2, 3, 4, 5: 100 g (11 ms) at 1 x I _N direction 6: 100 g (11 ms) at 0.8 x I _N with curves F1, F2: 100 g (11 ms) at 0.8 x I _N to IEC 60068-2-27, test Ea | | |
| Corrosion | 96 hours at 5 % salt mist, to IEC 60068-2-11, test Ka | | |
| Humidity | 240 hours at 95 % RH, to IEC 60068-2-78, test Cab | | |
| Mass | approx. 98 g per pole | | |

Ordering information

| | |
|---|---|
| Type No. | |
| 8340 | circuit breaker with toggle actuator |
| Mounting | |
| T | rail mounting |
| Configuration | |
| 1 | snap-on installation |
| Number of poles | |
| 1 | single pole protected |
| 2 | two pole protected |
| 3 | three pole protected |
| | } magnetic, hydraulic-magnetic |
| Panel hardware | |
| 0 | without panel hardware |
| Terminal design (main contact) | |
| K1 | recessed screw/pressure plates M4 |
| Characteristic curve *) | |
| Characteristic curve, instantaneous: | |
| F1 | DC |
| F2 | AC 50/60 Hz |
| Short delay: | |
| K1 | DC |
| K2 | AC 50/60 Hz |
| Medium delay: | |
| M1 | DC |
| M2 | AC 50/60 Hz |
| Long delay: | |
| T1 | DC |
| T2 | AC 50/60 Hz |
| Actuator colour / design | |
| A | black, long toggle |
| K | black, short toggle |
| Marking on actuator | |
| 0 | without marking |
| L | I-O; ON-OFF |
| M | I-O; ON-OFF (I_N , U_N , trip curve, schematic diagram on housing top) |
| N | I-O; ON-OFF (I_N , on housing top) |
| Auxiliary contacts | |
| H0 | without auxiliary contacts |
| H1 | with auxiliary contact |
| H2 | with auxiliary contact on one pole only (multipole) |
| Auxiliary contact function (see internal connection diagrams) | |
| 2 | 1 N/O contact |
| 3 | 1 N/C contact |
| Auxiliary contact terminal design | |
| 6 | screw/pressure plate M3 |
| Current ratings | |
| 0.02...50 A | |
| 8340 - T 1 1 0 - K1 M1 - A L H1 2 6 - 10 A ordering example | |

Approvals

| Authority | Standard | Rated voltage | Current ratings |
|------------------------------------|----------------|---|---|
| VDE | IEC / EN 60934 | AC 240/415 V AC 240 V DC 80 V | 0.02 A...30 A 0.02 A...30 A 0.02 A...50 A |
| UL | UL 1077 | AC 250 V DC 80 V DC 80 V | 0.02 A...30 A 0.02 A...50 A 100 A (2 poles in parallel) |
| UL | UL 489A | DC 80 V | 0.05 A...30 A (1 + 2 pole) |
| CSA | C22.2 No 235 | AC 250 V DC 80 V | 0.02 A...30 A 0.02 A...30 A |
| CQC | GB 17701 | AC 240/415 V AC 240 V DC 80 V | 0.02 A...30 A 0.02 A...30 A 0.02 A...50 A |
| QPL Sweden Defence Material Admin. | MIL-C-55629 | AC 240 V DC 50 V AC 240 V AC 240 / 415 V | 1 A...30 A (8340-F410) 1 A...30 A (8340-410) 1 A...30 A (8340-F420) 1 A...30 A (8340-F430) |

This is a metric design and millimeter dimensions take precedence ($\frac{mm}{inch}$)

*) Other characteristic curves upon request (e.g. pulse delayed, for high inrush currents or capacitive loads)

Dimensions

long toggle

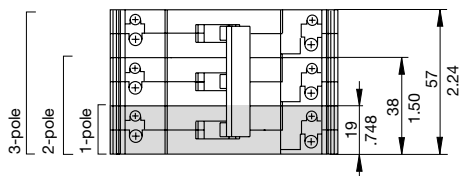
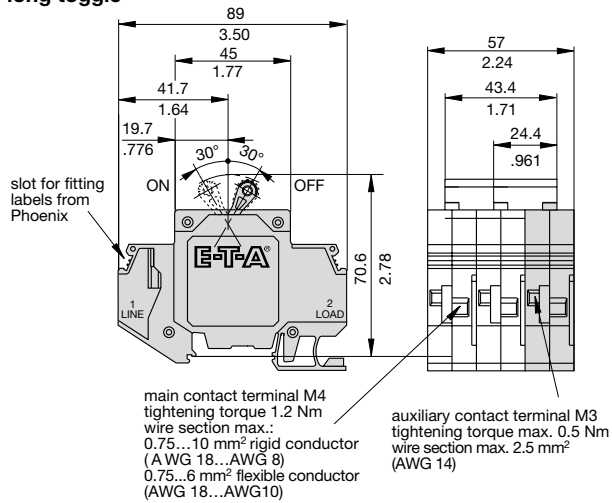

short toggle

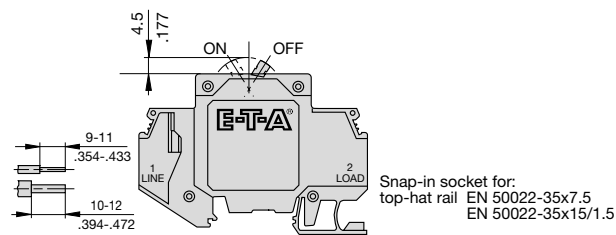

Installation drawing

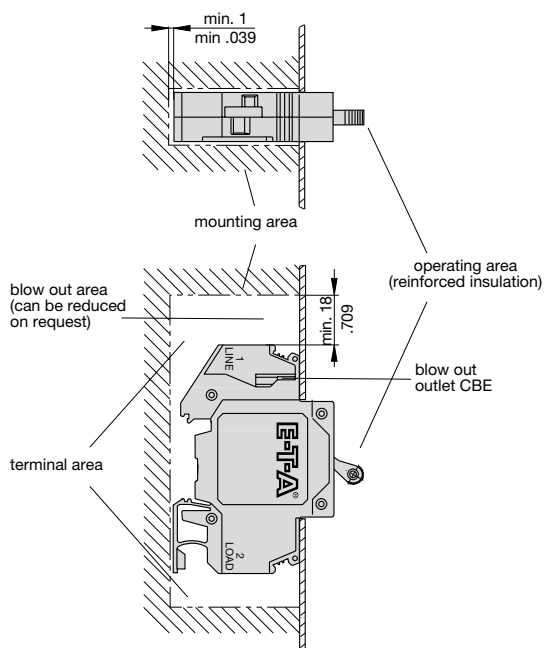

Internal connection diagrams

1-pole protected magnetically

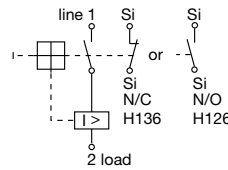

multipole

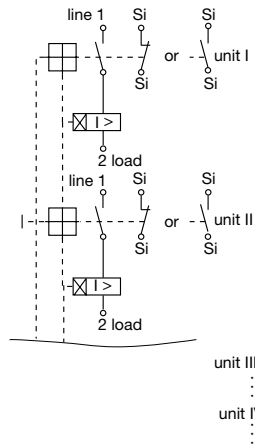

1-pole protected hydraulic-magnetically

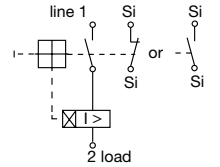

Optional N/C or N/O auxiliary contact (Si)

Shock directions

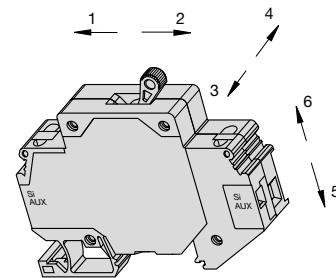

Typical time/current characteristics at 23 °C / +73.4 °F

Curve F1 (instantaneous) for DC

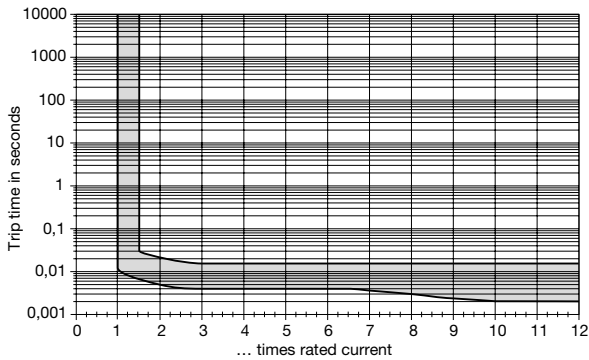

Curve F2 (instantaneous) for AC

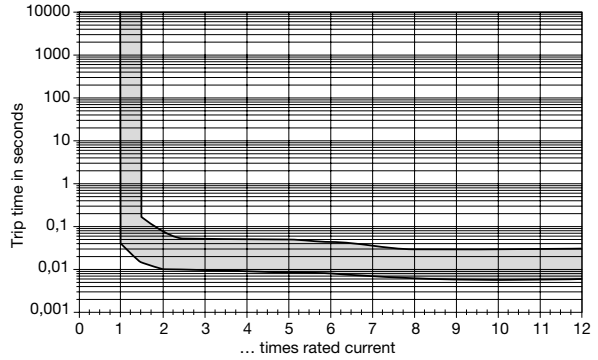

Curve K1 (short delay) for DC

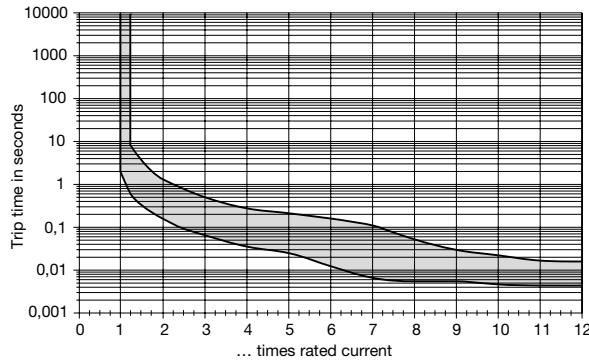

Curve K2 (short delay) for AC 50/60 Hz

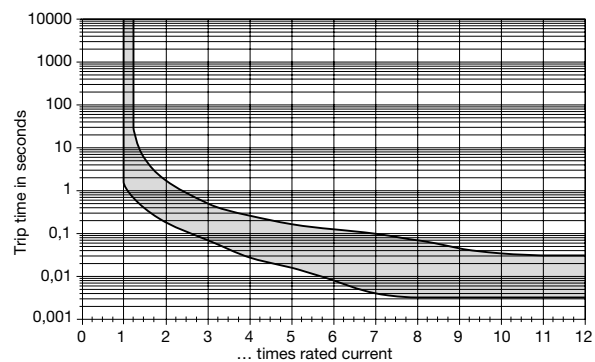

Curve M1 (medium delay) for DC

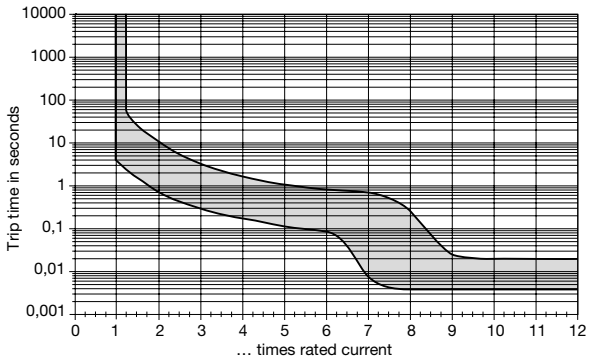

Curve M2 (medium delay) for AC 50/60 Hz

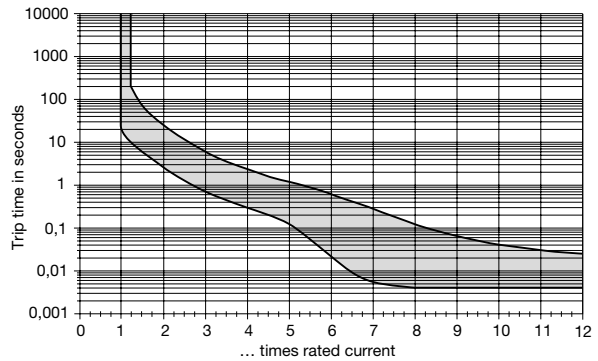

Curve T1 (long delay) for DC

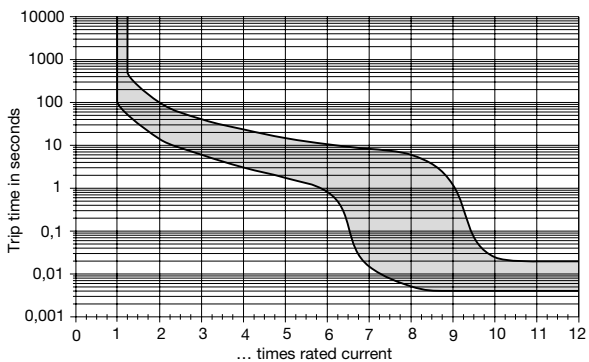

Curve T2 (long delay) for AC 50/60 Hz

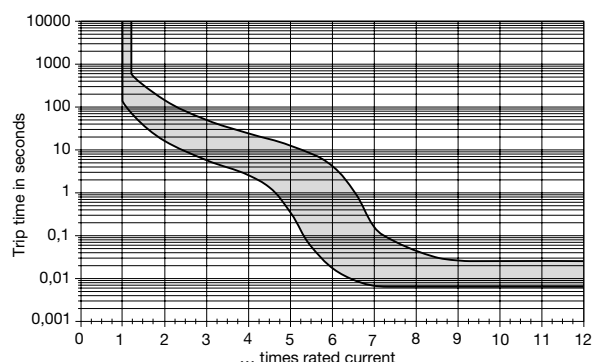

N.B. All curves will only be maintained if the escutcheon is mounted on a vertical surface. Ambient temperature or mounting side-by-side does not influence the trip curve, derating is not required. The breakers may trip in the event of current peaks < 0.003 sec. For these applications we offer a mechanical pulse delay – please enquire.
Other characteristic curves upon request (e.g. pulse delayed, for high inrush currents or capacitive loads).

Accessories

Connector bus links -K10

X210 589 01/2.5 mm², (AWG 14) (black) up to 20 A max. load
X210 589 02/1.5 mm², (AWG 16) (brown) up to 13 A max. load

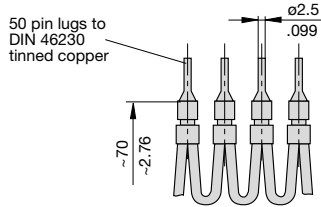

Busbar 1-pole
Y 308 495 01

The one metre long busbars can be cut to suitable lengths. Plug-on caps can be fitted on the ends to provide brush contact protection.

I_{max} - busbar 100 A (40 °C)

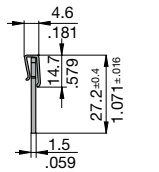
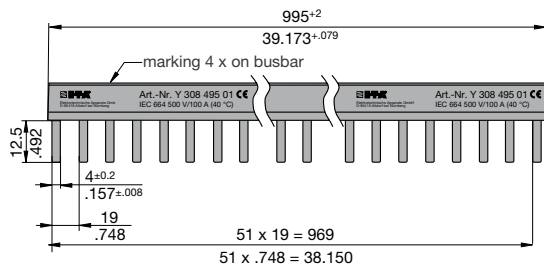

Plug-on cap, 1-pole
Y 307 851 01



Busbar 2-pole
Y 308 496 01

I_{max} - busbar 100 A (40 °C)

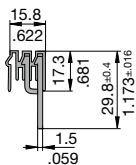
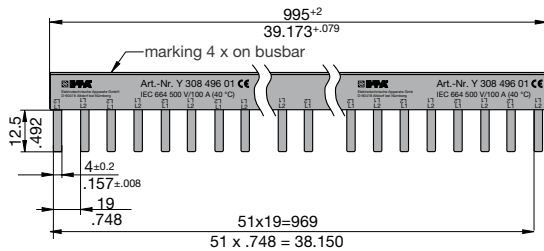

Plug-on cap, busbar 2/3-pole
Y 308 506 01

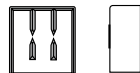

Busbar 3-pole
Y 308 497 01

I_{max} - busbar 100 A (40 °C)

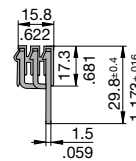
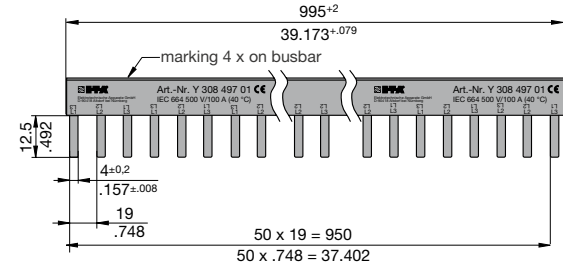

Plug-on cap, busbar 2/3-pole
Y 308 506 01

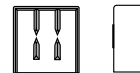

Supply terminal I_{max} 63 A
Y 308 504 01

Max. tightening torque of terminal screw 2 Nm
 Max. cable cross section: 25 mm² / single strand
 16 mm² / multistrand with wire end ferrule

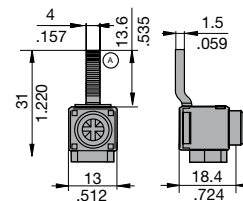

Caution:

When using multipole busbars please leave at least one pole's width between two adjacent line entry terminals.

This is a metric design and millimeter dimensions take precedence (mm / inch)

All dimensions without tolerances are for reference only. In the interest of improved design, performance and cost effectiveness the right to make changes in these specifications without notice is reserved. Product markings may not be exactly as the ordering codes. Errors and omissions excepted.

