

## Cable connector - CA-16S1N8AT006 - 1620273

Please be informed that the data shown in this PDF Document is generated from our Online Catalog. Please find the complete data in the user's documentation. Our General Terms of Use for Downloads are valid (<http://phoenixcontact.com/download>)

Cable connector, angled, shielded: yes, Screw locking, M23, No. of pos.: 16, type of contact: Socket, Crimp connection, cable diameter range: 4 mm ... 6 mm



The figure shows the 12-pos. product version

### Why buy this product

- Angled cable outlet for confined spaces
- Can be adapted to various applications, thanks to adjustable cable outlet direction
- Safe use in the field, thanks to high degree of protection
- Connector for flexible on-site assembly
- Consistent EMC protection for reliable transmission of signals
- Crimping connection: vibration- and temperature-resistant assembly



### Key Commercial Data

Packing unit	1 STK
GTIN	
GTIN	4046356818131

### Technical data

#### Temperature range

Ambient temperature (operation)	-40 °C ... 125 °C
---------------------------------	-------------------

#### Data of the insulating body

Note	Order information: Order crimp contacts separately
Coding	N
Insulator material	PA 6.6
Contact connection method	Crimp connection
Type of contacts	Socket
Application	Signal
Number of positions	16

# Cable connector - CA-16S1N8AT006 - 1620273

## Technical data

### Data of the insulating body

Contact diameter of power contacts	1 mm
Nominal current per power contact at 25°C	8 A
Nominal voltage, power contact	150 V
Rated surge voltage	1.5 kV
Overvoltage category	II
Degree of pollution	3

### Housing data

Housing material	Turned parts: copper zinc alloy (CuZn), die-cast parts: zinc (GD-Zn)
Type of locking	Screw locking
Degree of protection (when plugged in)	IP67
Thread type	M23

### Cable seal data

Cable diameter	4 mm ... 6 mm
Sealing material	NBR

### Environmental Product Compliance

REACH SVHC	Lead 7439-92-1
China RoHS	Environmentally Friendly Use Period = 50
	For details about hazardous substances go to tab "Downloads", Category "Manufacturer's declaration"

## Drawings

Dimensional drawing

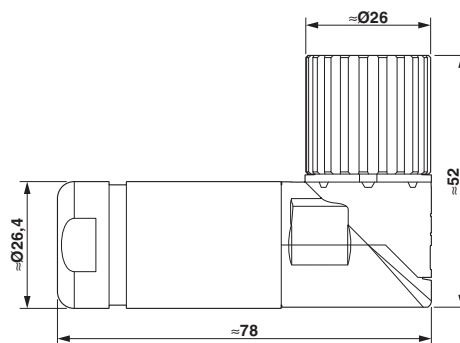

## Approvals

### Approvals

Approvals

UL Recognized / cUL Recognized / cULus Recognized

# Cable connector - CA-16S1N8AT006 - 1620273

## Approvals

Ex Approvals

### Approval details

UL Recognized		<a href="http://database.ul.com/cgi-bin/XYV/template/LISEXT/1FRAME/index.htm">http://database.ul.com/cgi-bin/XYV/template/LISEXT/1FRAME/index.htm</a> E335019-20141210
Nominal voltage UN	150 V	
Nominal current IN	5 A	
mm <sup>2</sup> /AWG/kcmil	20	

cUL Recognized		<a href="http://database.ul.com/cgi-bin/XYV/template/LISEXT/1FRAME/index.htm">http://database.ul.com/cgi-bin/XYV/template/LISEXT/1FRAME/index.htm</a> E335019-20141210
Nominal voltage UN	150 V	
Nominal current IN	3 A	
mm <sup>2</sup> /AWG/kcmil	20	

cULus Recognized	
------------------	---

Phoenix Contact 2018 © - all rights reserved  
<http://www.phoenixcontact.com>

PHOENIX CONTACT GmbH & Co. KG  
Flachsmarktstr. 8  
32825 Blomberg  
Germany  
Tel. +49 5235 300  
Fax +49 5235 3 41200  
<http://www.phoenixcontact.com>